

MANUAL OF TEMPORARY TRAFFIC CONTROL

2021 EDITION



FOREWORD

The 2021 Manual of Temporary Traffic Control (MTTC) updates and supersedes the 2012 Procedures for On-Street Construction Safety Manual. It supplements and should be used in conjunction with the latest edition of the Manual of Uniform Traffic Control Devices for Canada (MUTCDC), with the goal of adapting the basic principles of the MUTCDC to the City of Edmonton context.

The MTTC is developed under the authority of Traffic Bylaw 5590, and provides the minimum safety precautions that should be taken at worksites to protect workers and the travelling public. It provides guidance on planning and implementing temporary traffic control when work sites or special events interfere with travel on sidewalks, bike infrastructure or roadways in Edmonton.

The MTTC was developed by the Parks and Roads Services Branch of the City of Edmonton. We would like to recognize the many individuals across the City of Edmonton as well as members of industry, whose combined efforts and feedback made this manual possible.

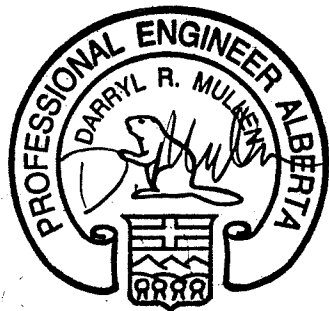

2021-03-26

PERMIT TO PRACTICE THE CITY OF EDMONTON
Signature <u> <i>JRM</i> </u>
Date <u> 2021-03-26 </u>
PERMIT NUMBER: P 05038 The Association of Professional Engineers and Geoscientists of Alberta

TABLE OF CONTENTS

INTRODUCTION

1.0 PLANNING YOUR TEMPORARY TRAFFIC CONTROL

1.1 BACKGROUND	5
1.2 IMPACTS TO TRAFFIC	7
1.3 PEDESTRIAN AND CYCLIST OBSTRUCTIONS	8
1.4 PUBLIC NOTIFICATIONS	13
1.5 TEMPORARY PARKING BANS	14
1.6 WORK ZONE SPEED REDUCTIONS	15
1.7 TEMPORARY TRAFFIC CONTROL DEVICES	17
1.8 SYMBOLS USED IN TRAFFIC ACCOMMODATION PLANS	28
1.9 SUMMARY CHECKLIST	30

2.0 REQUIREMENTS FOR SET-UP, MAINTENANCE AND TAKEDOWN

2.1 BACKGROUND	32
2.2 FLAGPERSON DUTIES AND RESPONSIBILITIES	32
2.3 PROCEDURES FOR PROSECUTION OF VIOLATIONS AGAINST FLAGPERSON	34
2.4 TRAFFIC CONTROL SET-UP AND SIGN PLACEMENT	34
2.5 RECORD KEEPING	37
2.6 MATERIAL STORAGE	38
2.7 SITE UPKEEP	39
2.8 SUMMARY CHECKLIST	41

3.0 TYPICAL DRAWINGS

3.1 BACKGROUND	42
3.2 SERIES A: COMPLETE AND PARTIAL ROAD CLOSURES	43
3.3 SERIES B: FLAGGING AND SHORT DURATION OPERATIONS	50
3.4 SERIES C: PEDESTRIAN AND CYCLIST ACCOMMODATIONS	55

INTRODUCTION

The Manual of Temporary Traffic Control (MTTC) provides guidance on planning and implementing temporary traffic control when work sites or special events interfere with travel on sidewalks, bike infrastructure or roadways in Edmonton. It identifies minimum safety precautions which should be taken at worksites to protect workers and the travelling public. Under Traffic Bylaw 5590, the City of Edmonton has the final authority on placement of temporary traffic control devices on public right-of-way. The following topics are addressed:

- + Guidance on developing your Traffic Accommodation Plan, Traffic Accommodation Strategy and/or Transportation Management Plan
- + Requirements to follow when setting-up, maintaining and taking down your worksite
- + Typical drawings of common worksite set-ups

The manual is intended to be a practical working guide for designing and maintaining your work zone. It focuses predominantly on the technical aspects of working on public right-of-way. Other resources, including the City of Edmonton's [On-Street Construction and Maintenance \(OSCAM\) website](#), addresses the procedural side such as permits and application details.

Note: When and where there may be a conflict between this manual and the Occupational Health and Safety Act, the Occupational Health and Safety Act shall apply.

1.0 PLANNING YOUR TEMPORARY TRAFFIC CONTROL

1.1 BACKGROUND

The purpose of this chapter is to provide procedures, guidelines and performance requirements for planning temporary traffic control when work impacts public right-of-way. It is a valuable resource for developing your Traffic Accommodation Plan or Strategy. The following topics are addressed:

- + General work zone principles and definitions
- + Accommodation of all travel modes (pedestrians, cyclists, transit and vehicles)
- + Use of specific temporary traffic control devices and work zone safety measures
- + Requirements for public notifications

At the end of this section, a Summary Checklist is provided that should be reviewed while planning your work.

This manual provides only a starting point. The Transportation Association of Canada has other key resources for planning and designing your work zone:

- + [Manual of Uniform Traffic Control Devices for Canada](#)
- + [National Guidelines for Work Zone Safety in Canada](#)

Responsibilities

When planning work on public right-of-way, contractors are responsible for ensuring they have obtained the appropriate documentation and approvals, from permits to the Traffic Accommodation Plan. The contractor must be knowledgeable of processing timelines in order to ensure that enough time has been allocated for the permitting and project review process to occur. In turn, the City of Edmonton provides information and guidance on requirements, reviews work impacts to road right-of-way and issues the permits.

Duration of Work

The length of time that work will affect public right-of-way is a key consideration in determining the appropriate traffic accommodation. The following definitions for work duration are used throughout the manual.

Mobile

Mobile operations are those that are typically performed on the move at low speed and may require periodic stopping for only a few minutes.

Examples of mobile operations are: street sweeping, longitudinal pavement marking-paint truck, watering of trees and hydro-seeding.

Very short duration

Very short duration operations are those that can be completed in 30 minutes or less and may be stationary or mobile with frequent short stops.

Examples of very short duration operations are: minor utility and roadwork, bus shelter washing, catch basin cleanout, pothole patching/repair, symbol and transverse road markings maintenance, minor sign maintenance, signal light replacement, streetlight fixture maintenance, survey and emergency response (e.g., spills and vehicular accidents).

Short duration

Short duration operations are stationary and range between 30 minutes and 24 hours.

Examples of short duration operations are: crack sealing, maintenance, sidewalk/boulevard repair, utility work, asphalt patching, emergency water-main repairs and emergency response (e.g., spills and vehicular accidents).

Long duration

Long duration operations are stationary and take longer than 24 hours.

Examples of long duration operations are: manhole replacement, utility replacement, bridge rehabilitation, roadway upgrading (e.g., interchange construction), large paving operations and sidewalk/boulevard replacement.

Work Zone Components

Traffic is guided around the work area through the placement of temporary traffic control devices such as signs, barricades and traffic cones. These devices direct traffic through the common work zone areas as shown below. As each situation will be different, contractors should determine the requirements for suitable site protection.

These work zone components are applicable when directing any mode of traffic. Where multiple modes are affected, each work zone component is typically applied individually for each mode. Temporary sidewalks or bike infrastructure that have been developed in a curbside lane are typically treated similar to a work space.

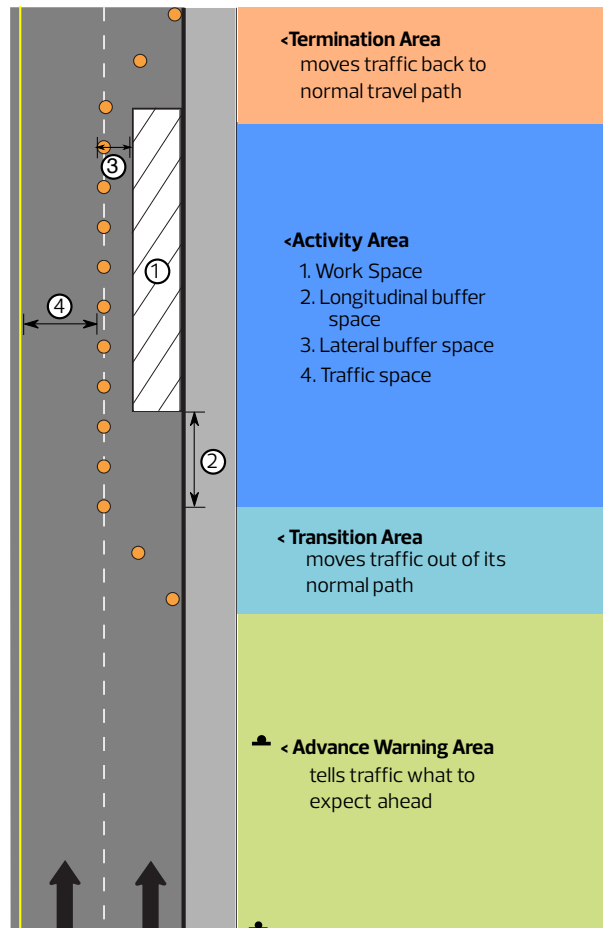

1.2 IMPACTS TO TRAFFIC

When conducting work that impacts City right-of-way, contractors must assess the impact to traffic. To begin with, it is important to study the existing nature of traffic at the proposed worksite and determine the impact to each mode of travel.

Pedestrians and Cyclists

For work that impacts pedestrians and cyclists, see 1.3 Pedestrian and Cyclist Obstructions.

Transit Obstructions

If you are working on a bus route and impacting transit, you must notify Edmonton Transit Service at copsetsplanningtechs@edmonton.ca.

Vehicle Obstructions

When impacting vehicle travel, the following performance guidelines must be followed:

- + Peak hours in Edmonton are typically from 6:00–9:00, and from 15:30 to 18:30, Monday through Friday excluding holidays. During these times, work is not allowed to impact traffic on freeways, arterial roads, collector roads, and all roads within the OSCAM Permit Core Area, except in emergencies or where Parks and Roads Services has given approval through an OSCAM Permit.
- + Work on arterial roads should be done during night time hours and on weekends whenever possible.
- + If working at a signalized intersection, signal timings should be adjusted to optimize vehicle flow.

1.3 PEDESTRIAN AND CYCLIST OBSTRUCTIONS

When developing temporary traffic control, pedestrians and cyclists should be prioritized wherever feasible. Pedestrians and cyclists are vulnerable road users, which makes them particularly sensitive to temporary changes in the road configuration. As the City redevelops, it is important that maintenance, construction and development projects don't inadvertently make it more difficult for people to walk, wheel and cycle.

This section provides guidance around choosing and designing temporary traffic control for pedestrians and cyclists of all ages and abilities.

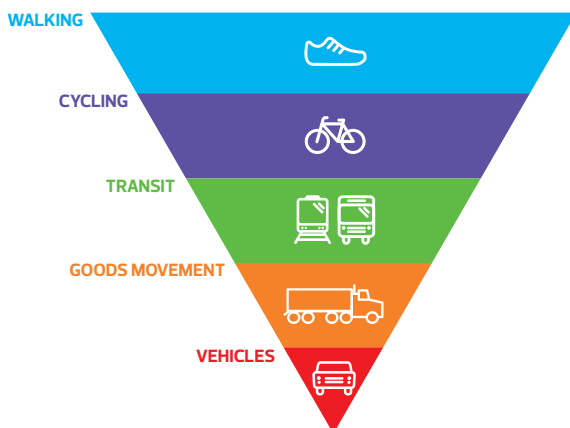

When do pedestrians and cyclists need to be accommodated? Unless otherwise approved by the City:

Pedestrians shall be accommodated when work impacts a sidewalk, shared pathway, shared space or crosswalk.

Cyclists shall be accommodated when work affects designated bike routes, as identified on the City of Edmonton's [Bike Map](#). Designated bike routes include protected bike lanes, painted bike lanes, shared roadways and shared pathways.

Choosing your Pedestrian and/or Cyclist Temporary Traffic Control

Mobile and very short duration work

For mobile and very short duration work, flagpeople or workers can be used to stop and provide direction to pedestrian and cyclist traffic.

Short duration work

For short duration work, developing temporary facilities is preferred when work requires a sidewalk or bike facility closure. Due to the short time period, these facilities are typically developed by using lightweight temporary traffic control devices, such as signs, cones and light barricades.

Table 1 provides guidance on preferred treatments for accommodating pedestrians and cyclists during short duration work. "Sidewalk Closed: Cross to the Other Side" and "Cyclists Dismount and Walk" treatments are discouraged, as they create a low level of service. The table should be applied in context of the site, considering factors such as land use, safety, duration of work and vehicle travel delays.



Table 1: Short Duration – Sidewalk and Bicycle Facility Temporary Traffic Control Matrix

CLOSURE CONDITION	SIDEWALK CLOSED NO BIKE FACILITY	SHARED PATHWAY CLOSED	SIDEWALK CLOSED BIKE FACILITY OPEN	SIDEWALK OPEN BIKE FACILITY CLOSED	SIDEWALK CLOSED BIKE FACILITY CLOSED	SIDEWALK CLOSED BIKE FACILITY CLOSED
PARKING LANE OPEN	Temporary Sidewalk in Parking Lane	Temporary Shared Pathway in Parking Lane	Temporary Sidewalk in Bike Lane, Temporary Bike Lane in Parking Lane	Temporary Bike Facility in Parking Lane	Temporary Shared Pathway in Parking Lane	Temporary Shared Pathway in Parking Lane
TWO TRAVEL LANES OPEN PER DIRECTION NO PARKING	Temporary Sidewalk in Curbside Travel Lane	Temporary Shared Pathway in Curbside Travel Lane	Temporary Sidewalk in Bike Lane, Temporary Bike Lane in Curbside Lane	Temporary Bike Facility in Curbside Travel Lane	Temporary Shared Pathway in Curbside Travel Lane	Temporary Shared Pathway in Curbside Travel Lane
BIKE FACILITY OPEN			Temporary shared pathway in bike facility, if available width			
SIDEWALK OPEN ON ONE OR BOTH SIDES	Detour pedestrians to open sidewalk	Detour pedestrians to open sidewalk + Bike Detour or Cyclists Dismount and Walk ¹	Detour pedestrians to open sidewalk	Bike Detour or Cyclists Dismount and Walk ¹	Detour pedestrians to open sidewalk + Bike Detour or Cyclists Dismount and Walk ¹	Detour pedestrians to open sidewalk + Bike Detour or Cyclists Dismount and Walk ¹

MOST PREFERRED

LEAST PREFERRED

General: Table 1 is a guideline and must be considered in context of the project and roadway characteristics including land use and impacts to all travel modes.

1. Bike Detour and Cyclists Dismount and Walk options should be compared to determine which results in less delay. Detours should direct cyclists onto routes that provide a similar comfort level. Cyclists Dismount and Walk measures should be limited to 50 metres or less.
2. Where work activities only affect one-way traffic on a two-way bike facility, a "Yield to Oncoming Traffic" or flagperson treatment may be considered.
3. For shared roadway closures, cyclists should be detoured to a road with similar traffic volumes and speeds or "Cyclists Dismount and Walk" can be used for short distances.

Long duration

For long duration work, developing temporary facilities is preferred when work requires a sidewalk or bike facility closure. As the duration of work increases, it is feasible to make larger-scale changes and use sturdier barricades and channelization devices. Table 2 provides guidance on preferred treatments for accommodating pedestrians and cyclists for long duration work. The table should be applied in context of the site, considering factors such as the land use, safety, duration of work and vehicle travel delays.

“Sidewalk Closed: Cross to the Other Side” and “Cyclists Dismount and Walk” treatments are particularly discouraged for long duration work. In cases where no option exists to develop temporary pedestrian and/or cyclist facilities throughout construction, efforts should be made to implement these facilities whenever it is possible such as in off-peak hours or when the site is inactive. Midblock temporary crosswalks may also be considered when it is not feasible to develop a temporary pedestrian facility. Parks and Roads Services shall review and approve all midblock temporary crosswalks before implementation.

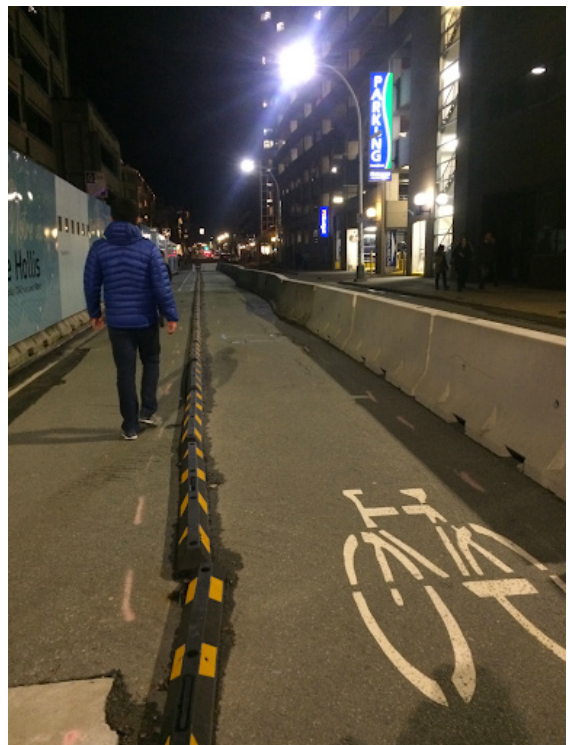

Table 2: Long Duration – Sidewalk and Bicycle Facility Temporary Traffic Control Matrix

CLOSURE CONDITION	SIDEWALK CLOSED NO BIKE FACILITY	SHARED PATHWAY CLOSED	SIDEWALK CLOSED BIKE FACILITY OPEN	SIDEWALK OPEN BIKE FACILITY CLOSED	SIDEWALK CLOSED BIKE FACILITY CLOSED	SIDEWALK CLOSED BIKE FACILITY CLOSED PARKING LANE CLOSED
PARKING LANE OPEN	Temporary Sidewalk in Parking Lane	Temporary Shared Pathway in Parking Lane	Temporary Bike Facility and Sidewalk in Bike Lane and Parking Lane	Temporary Bike Facility in Parking Lane	Temporary sidewalk and bike facility in parking lane ¹	
TWO TRAVEL LANES OPEN PER DIRECTION NO PARKING	Temporary Sidewalk in Curbside Travel Lane	Temporary Shared Pathway in Curbside Travel Lane	Temporary Bike Facility and Sidewalk in Bike Lane and Curbside Travel Lane	Temporary Bike Facility in Curbside Travel Lane	Temporary sidewalk and bike facility in curbside lane ¹	
BIKE FACILITY OPEN			Temporary shared pathway in bike facility, if available width			
SINGLE TRAVEL LANE OPEN IN EACH DIRECTION	Directional Closure and Temporary Sidewalk	Directional Closure and Temporary Shared Pathway	Directional Closure and Temporary Bike Facility and Sidewalk	Directional Closure and Temporary Bike Facility	Directional Closure and Temporary Bike Facility and Sidewalk ¹	Directional Closure and Temporary Bike Facility and Sidewalk
SIDEWALK OPEN ON ONE OR BOTH SIDES	Detour pedestrians to open sidewalk ²	Detour pedestrians to open sidewalk ² + Bike Detour or Cyclists Dismount and Walk ³	Detour pedestrians to open sidewalk ²	Bike Detour or Cyclists Dismount and Walk ³	Detour pedestrians to open sidewalk ² + Bike Detour or Cyclists Dismount and Walk ³	Detour pedestrians to open sidewalk ² + Bike Detour or Cyclists Dismount and Walk ³

MOST PREFERRED



LEAST PREFERRED

1. General: Table 1 is a guideline and must be considered in context of the project and roadway characteristics including land use and impacts to all travel modes.
2. If constrained, a temporary shared use pathway can be developed instead.
3. Midblock temporary crosswalks can be considered to reduce the delay to pedestrians for long duration work. Parks and Roads Services must review and approve all midblock temporary crosswalks before implementation.
4. Bike Detour and Cyclists Dismount and Walk options should be compared to determine which results in less delay. Detours should direct cyclists onto designated bike routes or other routes that have a similar comfort level as the infrastructure that they are on. Cyclists Dismount and Walk measures should be limited to 50 metres or less.
5. For shared roadway closures, cyclists should be detoured to a road with similar traffic volumes and speeds or "Cyclists Dismount and Walk" can be used for short distances.

Designing your Work Zone

When designing the temporary traffic accommodation, it is important to ensure the safety and protection of pedestrians and cyclists. The following principles should be followed when designing the work zone:

Protection from the Work Zone and its Hazards

- + The risks posed by the work activities to pedestrians and cyclists shall be assessed and addressed through temporary traffic control devices. Pedestrians and cyclists should be shielded from hazards and directed away from the work zone.
- + Where trenches or excavations are placed on sidewalks, a pedestrian bridge complete with handrails shall be installed.



- + Temporary pedestrian facilities, including overhead hoarding, should have adequate lighting when used in the dark.

Separation from Vehicles

- + Pedestrians shall be physically separated from vehicles in all cases.
- + For cyclists, physical separation should match or exceed the comfort provided by the original facility. For example, a painted bike lane can be diverted to a temporary facility that provides at minimum, separation from vehicles with a painted line.

Accommodation of Pedestrians with Limited Mobility or Low Vision

- + All temporary pedestrian sidewalks and shared pathways should be wheelchair accessible with a smooth hard surface clear of debris. Temporary ramps or the use of an existing ramp is required when pedestrians are being directed to a temporary walkway. Temporary ramps shall provide a smooth transition from the sidewalk and/or road.
- + Temporary ramps or bridges should have a slope no greater than 1:12, and should have colour contrast.



- + Clear, accessible paths for pedestrians shall be maintained to bus stops.
- + For long duration accommodations for pedestrians, all temporary traffic control devices should be detectable with a cane. This includes channelization devices, which should be continuous (i.e. placed without gaps).
- + For more information on accessibility, refer to the [City's Access Design Guide](#).

Facility Widths

When conducting partial closures or developing temporary provisions for pedestrians and cyclists, minimum widths clear of any hazards or obstructions must be provided, as shown below. Where feasible, widths above the minimum should be used.

- + Pedestrians: 1.5 – 1.8 m
- + Cyclists, one-way: 1.5 – 1.8 m
- + Cyclists, two-way: 2.0 – 3.0 m
- + Pedestrians/Cyclists, shared: 2.0 – 3.0 m

Maintenance and Aesthetics

- + Temporary sidewalks and bike infrastructure must be cleared of snow, ice and other debris.
- + For projects that are located in high pedestrian areas, the incorporation of artwork or other visual treatments should be considered on channelization devices like fences or overhead hoarding.

1.4 PUBLIC NOTIFICATIONS

Construction work that affects road right-of-way can have significant impacts to nearby residents, business owners and the travelling public. Notifying the public of required changes to their street use and travel patterns reduces frustration and inspires goodwill by allowing citizens to plan ahead.

- + For total closures or major disruptions, all affected businesses and residents should be notified by the contractor in writing 10 working days prior to the commencement of work. In addition, information signs shall be placed to provide advance warning to the travelling public. For total closures affecting motorists, information signs are generally placed at the nearest parallel and/or perpendicular arterial road.

**If a road no longer accommodates one or more travel modes, it is considered a total closure and notice must be given to the affected travel mode(s).*

- + Sidewalk Closed on One or Both Sides of the Road=Total Closure
- + Bike Infrastructure Closed=Total Closure
- + Buses Detoured=Total Closure, Edmonton Transit Service will provide the public notification.
- + Vehicle Travel Lanes Closed=Total Closure
- + For other activities that will disrupt adjacent and/or nearby properties such as changes to access or parking, all affected businesses and residents should be notified by the contractor in writing 5 working days prior to the commencement of work.
- + The written notice should include the purpose and duration of work, impacts to infrastructure, how road users will be accommodated throughout the project, and contact information.

1.5 TEMPORARY PARKING BANS

Temporary parking bans may be applied to paid or unpaid on-street parking to provide space for work activities or special events. They also may be used to facilitate transit detours or temporary facilities for pedestrians and cyclists. Requests to ban parking should be sent to Parks and Roads Services a minimum of 6 working days in advance of the proposed start of construction for review, approval, and processing.

Unpaid Parking Spaces

At unpaid parking spaces, the steps below are taken to ban parking:

1. Temporary "No-Parking" signs should be installed as follows:
 - + Regulatory "No-Parking" signs shall be used. Homemade signs are not acceptable and are not enforceable.
 - + The signs shall be mounted on portable A-Frames or vertical panels installed along the entire length of the desired zone and spaced approximately 20 to 30 metres apart. Where parking is in high demand, signs should be spaced closer together at approximately 10 metres apart. The A-Frame or vertical panel shall be labelled with the owner of the device.
 - + Placement of signs shall not obstruct pedestrian or cyclist movements.
 - + The zone shall have a defined beginning and end. The beginning or end is made up of an intersecting back lane, street or avenue. Private driveways are not considered beginning or ends of "No-Parking" zones.
2. When the signs are installed, a "No Parking" record form shall be filled out by an onsite representative and then forwarded to Parks and Roads Services. This form records the license plate numbers of any vehicles parked at the location prior to the signs being installed.

3. Temporary No Parking Signs should be installed well ahead of the proposed start of work. After the signs have been up for 72 hours, any remaining vehicle is considered abandoned under Traffic Bylaw 5590 and can be tagged and towed at the owner's expense. A vehicle may be courtesy towed at any time by an authorized Parks and Roads representative. A courtesy tow is done at the expense of the on-site agency who is requesting the temporary parking restriction.

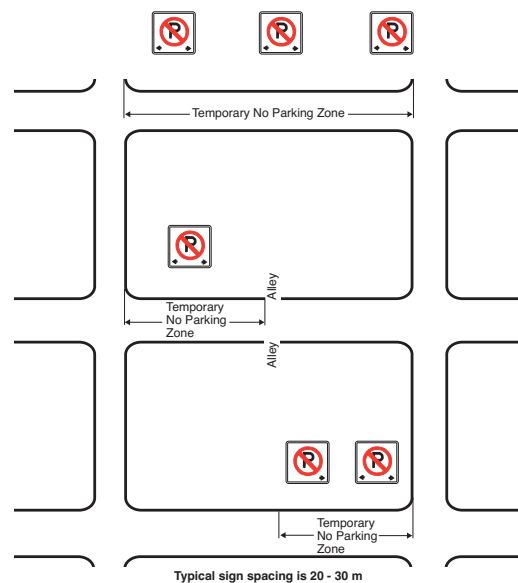

E-Park Zones (Paid Parking Spaces)

At E-Park Zones, contractors shall be responsible for paying for lost revenue during the temporary parking ban. Parks and Roads Services shall install the temporary "No Parking" zones and may also place a hood over the pay machine. Parks and Roads Services is the only agency that can install this type of parking ban.

1.6 WORK ZONE SPEED REDUCTIONS

Traffic Accommodation Plan

Requests to lower the speed limit must be submitted to Parks and Roads Services with your Traffic Accommodation Plan. Work zone speed reductions are only applied when temporary conditions have created a clear reason for motorists to slow down, as they are otherwise ineffective. All requests must include:

- + A diagram of the proposed work zone and proposed placement of work zone speed reduction signs.
- + Other proposed actions to be taken by the Prime Contractor to manage speed reduction within the work zone (i.e. flagperson control, electronic speed display board, lane narrowing, etc).
- + A list of identified hazards that require a work zone speed reduction. In order to be effective, work zone speed reductions must be supported by visual evidence from a motorist's perspective. Examples may include but are not limited to:
 - + Workers adjacent to moving traffic
 - + Change to roadway geometry that makes travel at existing speeds unsafe
 - + Deep excavations in close proximity to moving traffic
 - + Narrow lane widths
 - + Sight distance restrictions
 - + Temporary removal of guardrail or other permanent traffic barriers

Signage Requirements

- + Speed limits shall be reduced in increments of no greater than 30 km/h. Too large of a speed reduction creates a hazardous difference in speed between vehicles, and increases the potential for collisions.
- + There are two ways to sign work zone speed reductions. The first is using Maximum Speed Ahead (RB-05), Construction Zone Maximum (WD-AE10) and Construction Zone Ends (WD-AE7) signs. The Construction Zone Ends sign is used to identify the end of the work zone speed reduction. The second is using Maximum Speed Ahead (RB-05), Maximum Speed (RB-1), and Construction Zone Ends (WD-AE7) signs. In the second signing sequence, the end of the work zone speed reduction is displayed by using the Construction Zone Ends (WD-AE7) sign, followed by a Maximum Speed (RB-1) sign that shows the return to the speed limit.
- + With either signing option, Speed Fines Double Begins and Speed Fines Double Ends signs are encouraged to be used when workers are present. These signs remind drivers of the increased penalties for speeding in active work areas. Speed Fines Double signs must be covered or removed when workers are not present.

Signing Option #2:

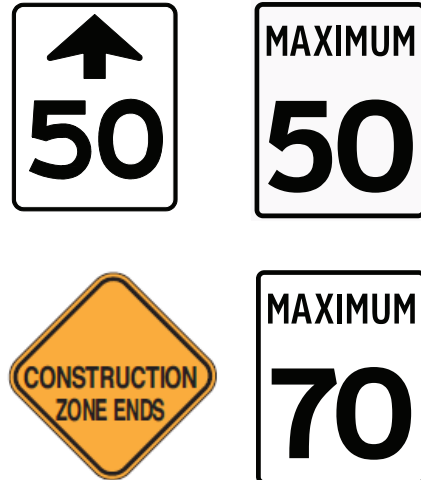

Speed Fines Double



Signing Option #1:



Set-Up and Maintenance

- + Work zone speed reductions shall be set-up according to the Traffic Accommodation Plan. The initial set-up can be completed by Parks and Roads Services or by contractors.
- + After installation, the Prime Contractor shall be responsible for monitoring and maintaining work zone speed reduction signs.
- + The Prime Contractor shall be responsible for the removal or covering of Work Zone Speed Reductions signs when no workers and/or hazards are present. This includes the re-installing or uncovering of existing speed limit signs.
- + The Prime Contractor shall be responsible for covering or removing Speed Fines Double signs when workers are not present.
- + All actions taken by the contractor shall be recorded on a "Record of Temporary Traffic Control" form or other acceptable alternative as approved by Parks and Roads Services.

Note: Work zone speed reductions must be removed or covered when not justified. If a reduced speed zone has been left posted while the site is inactive, such as weekends, evenings, etc., then the signs lose effectiveness with repeat traffic. This loss in effectiveness can be carried from one project to another.

1.7 TEMPORARY TRAFFIC CONTROL DEVICES

Signage

Signs are necessary for controlling, warning or guiding traffic through or around a work area. Each sign shall carry one message and must be placed such that the message is clear. Signs to be used after daylight hours should be made of retroreflective material. Illustrations of the various signs have been provided on the following pages.

Information Signs

Information signs are placed to notify the public of construction work, and should be used where outlined in the Public Notifications section.

Separate signs are placed for each travel mode (pedestrian, cyclist, and driver) that is affected. For transit users, Edmonton Transit Service provides notice of bus stop closures or detours.

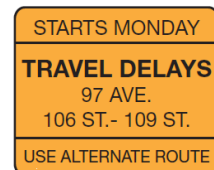

Information signs are typically static signs with custom messages. On arterial roads and freeways, Dynamic Message signs may be used to provide real-time information to drivers about travel impacts.

Detour Guide Signs

Detour Guide signs should be used to direct traffic when alternate routes should be taken. Custom signage may need to be developed where complex routing is required.



Regulatory Signs

Note: Stop and yield signs are installed and removed only by Parks and Roads Services, unless otherwise indicated.



Stop



Yield



Maximum
60 km/hr



60 km/hr Ahead



Do Not Enter



No Parking

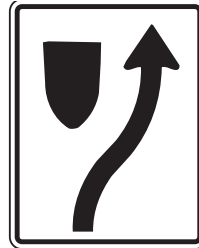

Keep Right

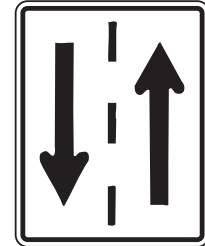

Two-Way Traffic



No Left Turn

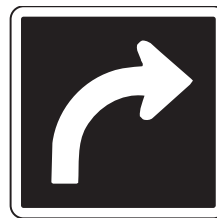

Right Turn



One Way

Advance Warning and Temporary Conditions Signs

Advance warning and temporary conditions signs must be made of minimum fluorescent orange diamond grade (DG3) material. All signs are 75 x 75 cm for speeds up to 70 km/hr and 90 x 90 cm for speeds of 80 km/hr and greater, unless otherwise indicated. Signs that are 60 x 60 cm may be used on roads with speeds of 60 km/h or less.



Note: To be used only when workers are present



Curve Warning



Right Lane Ends



Pavement Drop Off



Bump



This sign shall be displayed only when a flagsperson is actively controlling traffic.

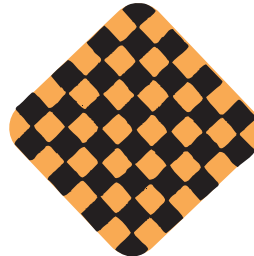

Checkerboard



Highway Divider



Trucks Crossing



Signals Ahead



Lane Closure Arrow
90 x 30 cm



Dual Lane Realignment



Road Diversion Ahead



Lane Realignment



Lane Closure Taper Sign



Pedestrian and Cyclist Signs



45 x 45 cm



45 x 45 cm



45 x 45 cm



45 x 45 cm



45 x 45 cm



45 x 75 cm



45 x 45 cm



45 x 45 cm



45 x 45 cm



45 x 75 cm



45 x 45 cm



45 x 45 cm



45 x 45 cm



30 x 30 cm



90 x 45 cm



60 x 45 cm



60 x 30 cm



30 x 15 cm



90 x 45 cm

Barricades

Retroreflective barricades shall be used to outline work area obstructions. Barricades shall not be used in place of a sign, and never placed in the line of traffic without advance warning signs. Some good examples of barricades and typical situations in which certain barricades are used as described on this page.

Worksite Barricades

Worksite barricades are used to delineate work areas and to identify a specific hazard.

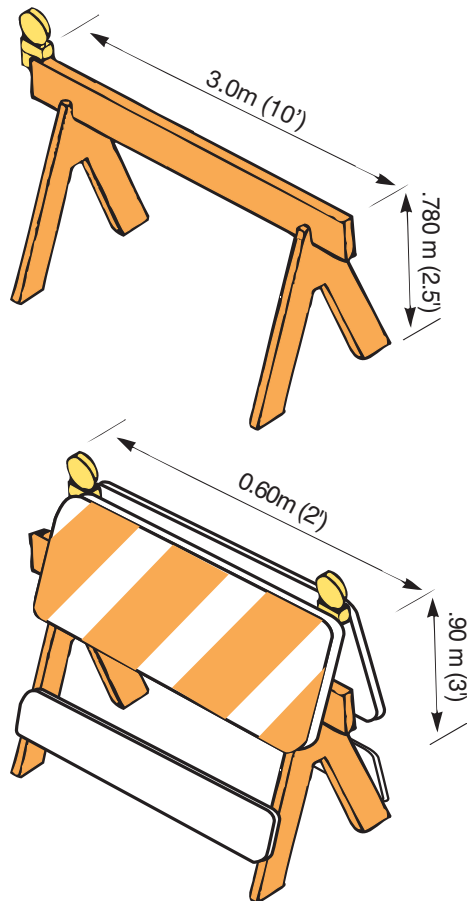

Traffic Control Barricade

Traffic control barricades are used to close streets, provide buffer zones and delineate work area obstructions. Traffic Control Barricades must be effective for night time visibility (i.e minimum reflectorization = 2500 sq.cm. DG3 in a reasonable state of repair)

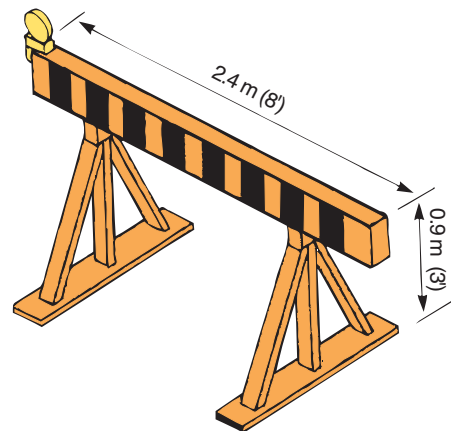

Precast Mini-Barriers

Precast mini-barriers are used to close streets and separate traffic through construction zones. They can also be used as a physical barrier to protect pedestrians and cyclists. Nose sections shall be used at either end of the mini-barriers, facing traffic.

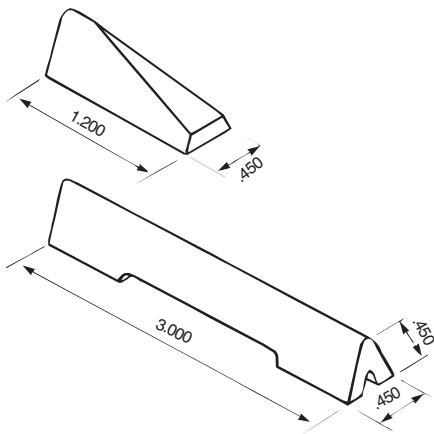

Concrete Jersey Barrier or Temporary Steel Barriers

Concrete jersey barriers or temporary steel barriers are used to separate traffic through construction zones, typically on high speed and/or high volume roadways. Appropriate end treatments should be used on the barriers.

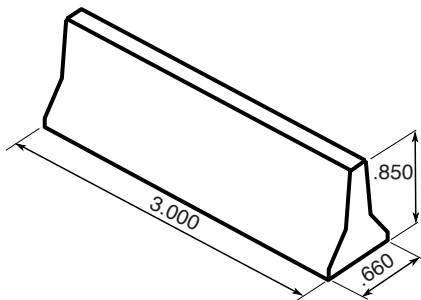

A-Frame

A-Frames are typically used to mount "Temporary No Parking" signs, and Advance warning signs.

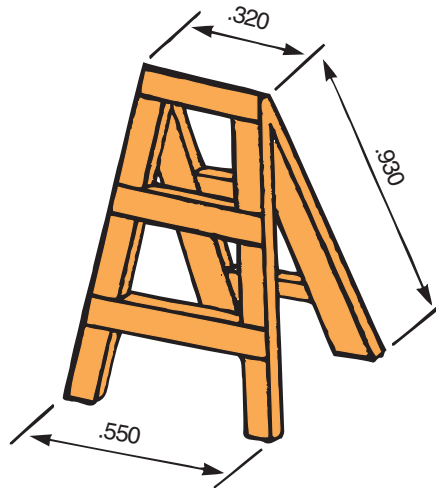

Channelization Devices

Channelization is a method of gradually reducing the width of a road while maintaining the flow of vehicles. Typically channelization involves closing a travel lane and merging traffic into the adjacent lane. Channelization may also involve shifting traffic from an existing lane to a detour lane or from a road to a detour road without reducing the actual number of travel lanes. Channelization devices are placed in series along a taper or along the length of a worksite to guide motorists around the worksite. Different channelization devices are suited to specific situations. Any devices which are used at night must be reflectorized or illuminated to show the same shape and color by night as by day.

Cones, Tubes and Flexible Drums

Cones or tubes are used in the taper of a lane closure on short-term daytime projects and can be used for night work if they have high intensity retroreflective material striping. The 1.0 m cones or tubes may be used as temporary separation for opposing directions of traffic. Use of these cones or tubes shall meet the following speed guidelines:

Cone or Tube Height Minimum: Roadway Speed

- + 18 Inches (0.45 m): 60 km/h or less
- + 28 Inches (0.70 m): 0 to 110 km/h

Flexible drums are used on long-term projects, along the edge of the road to outline the travel path or in high speed locations (70 km/h and greater) within the taper areas. Flexible Drums may be accompanied by steady burn lights to improve night time visibility. Flexible Drums shall have stripes of high intensity retroreflective material.

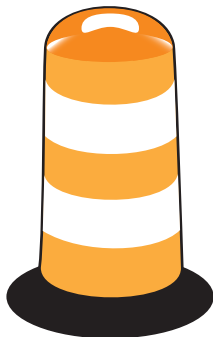
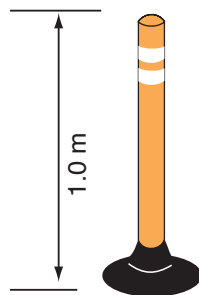
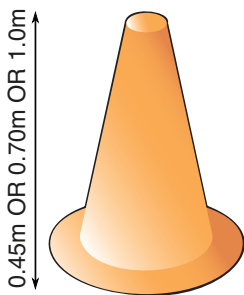

Vertical Panels or Chevrons

Vertical Panels or Chevrons may be used in the taper of a lane closure on a long term project or along the edge of a road to outline the travel path. Vertical Panels can be used to separate opposing directions of traffic provided that they are placed back to back. Vertical Panels and Chevrons shall be made of high intensity retroreflective material.

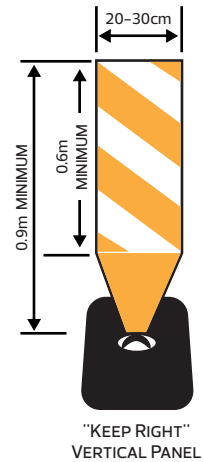
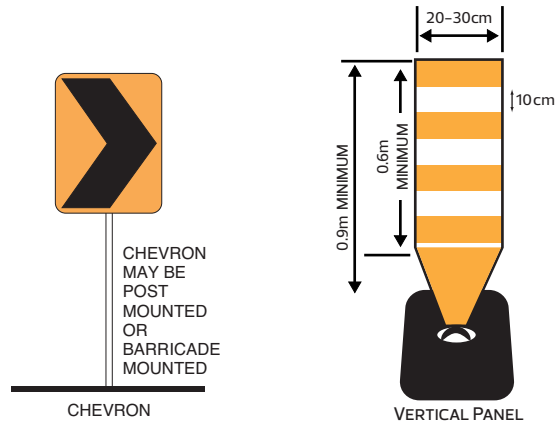

Specialty and Lighting Devices

Arrowboards

Arrowboards, when combined with advance warning signs and delineation devices, are especially useful in situations which require higher than normal visibility. Examples where arrowboards should be used are on overnight setups, high speed and high volume roadways (70 km/h and greater) and in poor weather conditions.

- + Recommended minimum size for an arrowboard is 900 mm x 1200 mm.
- + Light bars on vehicles may be used in emergency situations, or when speed limits are 60 km/h or less.

Steady Burn and Amber Flasher Lights

Steady burn lights or amber flashers can be used on barricades or channelization devices such as flexible drums or vertical panels to provide better night time guidance for motorists. They are typically used on roads that lack street-lighting.

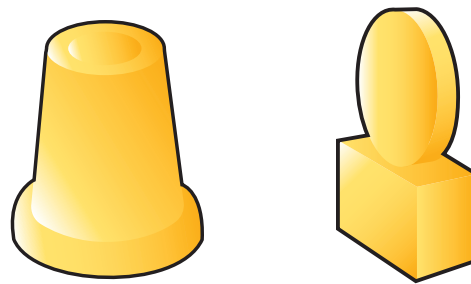

Back-Up Vehicles and



Arrow Pattern

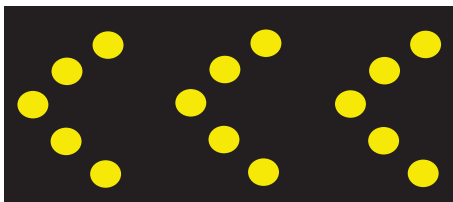

Chevron Pattern

Truck-Mounted Attenuators

Back-Up Vehicles (BUVs) are vehicles placed in advance of worksites, to provide additional warning and increase protection for workers. BUVs are placed with sufficient room from the mobile work vehicle or stationary worksite to allow for roll ahead space in the event of a collision while being close enough that drivers do not go around the BUV. Truck-mounted attenuators (TMA) can be attached to the BUV, as shown below, to further increase the protection.



- + Table 1 outlines the City of Edmonton's guidance and requirements for the use of BUVs and TMAs. Workers are exposed when they are outside of a vehicle and outside of a lane closure that has been set up with temporary traffic control. Workers are not considered to be exposed when they are inside a vehicle or inside a lane closure with temporary traffic control material.
- + BUVs are usually unoccupied unless used for mobile, very short or short duration work.
- + BUVs should be the heaviest vehicles available and must be equipped with strobe lights and arrowboard.
- + BUVs equipped with TMA are to be no lighter than specifications for the TMA being used, whether it is trailer mounted or truck mounted

Table 1-TMA / BUV Decision Matrix

POSTED SPEED	EQUAL TO OR GREATER THAN 80 KM/H		70 KM/H		EQUAL TO OR GREATER THAN 60 KM/H	
	NOT EXPOSED	EXPOSED	NOT EXPOSED	EXPOSED	NOT EXPOSED	EXPOSED
BUV ONLY	Highly Recommend	Required	Recommend	Required	Not Required	Recommend
BUV WITH TMA	Highly Recommend	Highly Recommend	Recommend	Recommend	Not Required	Not Required

- + Emergency communication between BUVs and workers shall be established and should include 2-way radios, vehicle horn, verbal, and hand signals.
- + Spacing of the BUV/TMA is as follows:
- + 70 km/h or greater – 30 – 60 metres
- + 60 km/h or less – 25 – 50 metres

Placement of Temporary Traffic Control Devices

Channelization devices (cones, chevrons, vertical panels, flexible drums) shall be placed at a specific spacing along a determined length of taper. The spacing and length of taper is determined by the speed limit of the road. When a lane is closed and traffic is forced to merge into the adjacent lane the taper is called a merging taper. When a taper is used to guide traffic, but not reduce the number of travel lanes, the taper is called a shifting taper. A shifting taper is equal to one half the length of a merging taper for an equal speed.

Table 3–Placement of Temporary Traffic Control Devices

SPEED LIMIT (KM/H)	SPACING BETWEEN SIGNS (M)	LENGTH OF TAPER (M)	LENGTH OF LONGITUDINAL BUFFER SPACE (M)	SPACING BETWEEN DELINEATION DEVICES (M)
≤50	50	30	35	8
60	50	40	45	12
70	75	60	50	15
80	100	80	60	15
90	100	105	65	18
100	125	125	70	18
110	125	145	75	20

1.8 SYMBOLS USED IN TRAFFIC ACCOMMODATION PLANS

When developing your Traffic Accommodation Plan, it may be helpful to use symbols to represent the proposed temporary traffic control devices. The below images provide some options for using symbols on your plan.

Signs

Symbol



Actual



Barricades

Symbol



Actual

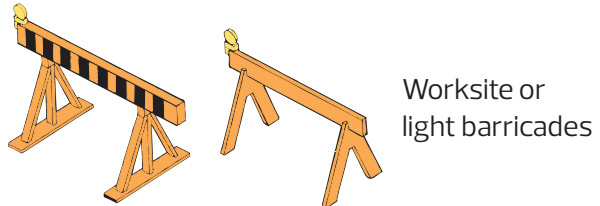
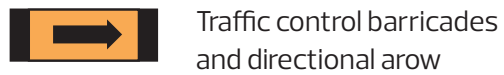

Mini-barrier

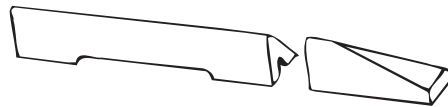

Precast mini-barrier and mini-barrier nose

Channelization Devices

Symbol

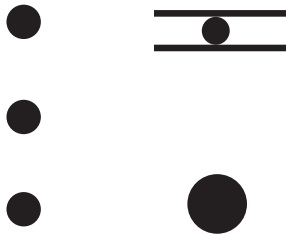

Actual

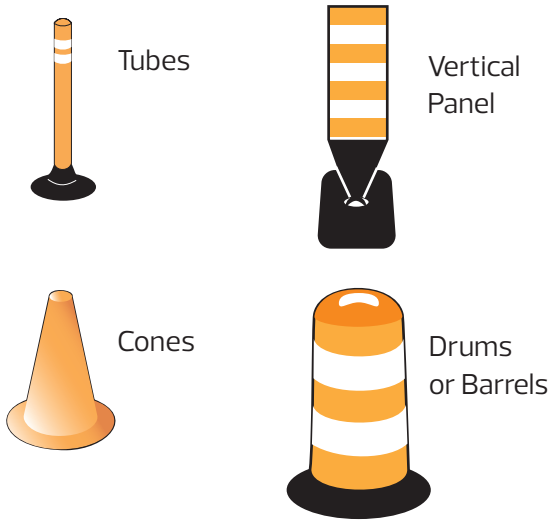

Lighting and Specialty Devices

Symbol



Actual

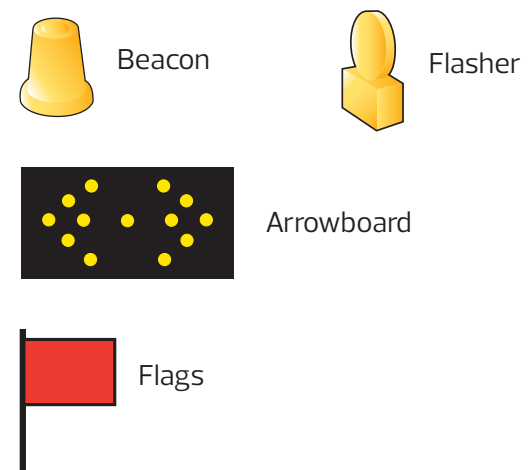

1.9 SUMMARY CHECKLIST

Planning your Temporary Traffic Control

Traffic Accommodation Plan

- Temporary traffic control devices have been planned to properly protect the work area and provide guidance to all travel modes.
- Where work impacts sidewalk(s) or bike infrastructure, temporary facilities have been developed, where feasible.
- If planning work on a bus route and impacting transit, Edmonton Transit Service has been contacted at copsetsplanningtechs@edmonton.ca.
- Work on arterial roads has not been planned during peak hours unless it is an emergency or otherwise approved by Parks and Roads Services. Peak hours are from 6:00–9:00, and from 15:30 to 18:30, Monday through Friday excluding holidays.
- Work on arterial roads has been planned during nighttime hours and on weekends, whenever possible.
- If working at a signalized intersection, the signal timings are planned to be adjusted to optimize vehicle flow.

Permits and Approvals

- OSCAM permit has been received.
- Traffic Accommodation Plan or Strategy has been reviewed and accepted by Parks and Roads Services.
- Noise bylaw waiver has been received, if planning to work outside the permitted hours of work under the City of Edmonton's noise bylaw.
- Utility Line Assignment (ULA) Permit has been received, if work involves excavation for new underground utility installations, and/or above ground pedestals on road right-of-way, excluding gas, water and sewer services to individual properties.

Other

- Alberta 1 Call Corporation (1-800-242-3447) and other necessary companies have been contacted for utility location.
- Notice has been given to the public, including surrounding businesses and residents, where applicable.
- Arrangements have been made to acquire the temporary traffic control devices.

2.0 REQUIREMENTS DURING SET-UP, PROJECT DURATION AND TAKE-DOWN

2.1 BACKGROUND

Once the OSCAM permit has been issued and the Traffic Accommodation Plan reviewed and accepted, work may commence, starting with properly setting up the temporary traffic control. Requirements during the project include proper:

- + Record keeping
- + Traffic control setup and sign placement
- + Maintenance and upkeep of the site
- + Storage of temporary traffic control materials

The requirements during the job identify the minimum safety precautions that should be taken at the worksite and standards of performance that should be adhered to in order to maintain a safe and accessible environment for both workers and roadway users. The City of Edmonton is the final authority on temporary traffic control standards and setups and shall decide the extent of traffic disruption permitted on City owned roadways.

At the end of this section, a Summary Checklist is provided that should be reviewed prior to commencing the work, during the work, and once the work has been completed to ensure City of Edmonton requirements are being met.

Responsibilities

The City of Edmonton has the final authority to ensure proper placement of temporary traffic control devices on road right-of-way. This authority is granted through Traffic Bylaw 5590.

It is the responsibility of the applicant to accurately maintain the start and completion dates of the OSCAM permit. A copy of the permit shall be on site at all times, and should be publicly displayed.

The on-site agency and project site supervisor are responsible for obtaining, placing and maintaining temporary traffic control devices for all traffic interruptions on road right-of-way including work on sidewalks and bike infrastructure. The responsibility of the on-site agency and the project site supervisor shall remain in place until final completion of the project. This includes any and all restoration work required. Responsibilities also include:

- + Proper training (certification)
- + Proper apparel
- + Proper inspection procedures
- + Proper documentation

Non-Compliance: All work to be done on road right-of-way shall meet the policies and procedures of the City of Edmonton, including the ones outlined in this manual. In the event of non-compliance in the set-up, maintenance or take-down of the worksite, Parks and Roads Services will take the following actions.

- + As a first step, Parks and Roads Services will send the contractor a "Notice of Non-Compliance" identifying the issue. If the issue is creating a serious safety hazard, Parks and Roads Services may skip this step and take immediate action as per Step 2.
- + If the contractor fails to resolve the concern, or has received multiple notices, Parks and Road Services will do one or more of the following:
 - + Remove signs and/or other temporary traffic control, at the contractor's cost
 - + Suspend or revoke all temporary road use permits (OSCAM, Moving, etc)

2.2 FLAGPERSON DUTIES AND RESPONSIBILITIES

Flagpeople have a vital job being the front-line contact with the public. In this capacity, flagpeople must be alert and courteous. Flagpeople must understand their duties and be able to signal to drivers, cyclists and pedestrians so that they understand their directions.

Flagperson procedures differ between various types of construction projects. The flagperson must continually adapt procedures to accommodate the safe flow of traffic around a construction site.

The following section is a brief overview of flagging procedures, responsibilities and equipment. Any individual who will be acting as a flagperson on a regular basis must be properly trained in flagging. To obtain information regarding the flagperson training course you may contact the Alberta Construction Safety Association (ACSA) or the Training and Development section of Parks and Roads Services.

Requirements for the use of Flagpeople

Flagpeople may be used to direct traffic for mobile operations, very short duration work and short duration work. There are several traffic accommodation scenarios that could make use of flagpeople to direct pedestrians, cyclists, and motorists through work areas. Two or more flagpeople may be required depending on the type and complexity of the setup.

Flagpeople and Pedestrians

Special consideration must be taken when flagpeople are being used for guiding pedestrians. Flagpeople may be used on worksites that are complex to navigate or when sidewalks need to be blocked off temporarily when hoisting or moving equipment over the walkway. Pedestrians do not respond well to signs so attention must be paid

to ensure instructions are communicated clearly as to where and when to proceed. Flagpeople used for directing cyclists should follow similar procedures as directing motorists.

Equipment

The industry standard requires that a flagperson must wear yellow/green coveralls with retroreflective stripes, a fluorescent hard hat, and protective footwear. The hard hat must have reflective stripes if work is being completed in the dark. A standard Stop/Slow paddle, either hand held or pole mounted should be used for day time use. For night time work, a flashlight with a semi-transparent red cone or an illuminated paddle is used in addition to the Stop/Slow paddle. Flags should only be used in emergencies.

Communication devices should be used when visual contact between flaggers cannot be maintained.

If flagpeople are required to work during hours of darkness and there is no street lighting present, proper illumination should be provided for flagpeople. "Traffic Control Person Ahead" and "Be Prepared To Stop" signage (as shown in the 3.3 Series B example set-ups) should always be set up when flagging is required for motorists.

Signaling Procedures

Signaling equipment shown below must be kept in good condition. The figures below illustrate the hand signals to be used by flagpeople for controlling traffic. It is important to be clear in your signaling and to stand so that oncoming traffic has a clear view of the appropriate signal.

- + Keep the stop/slow sign held high, in the line of sight for approaching drivers.
- + Make direct eye contact with the driver.
- + Use your free hand to signal to the driver. Do not swing or wave the stop/slow sign.
- + Give drivers time to react to your signals. Give them more time to react if the speed of the traffic is high or if the weather and/or visibility is less than ideal.
- + Never stand directly in front of oncoming traffic. Stand on the shoulder or curb of the roadway where possible.
- + Never turn your back on traffic.
- + Follow the illustration below to stop, slow or release traffic.
- + At traffic signals, the traffic should be stopped at the same time as the red signal is showing. Do not stop traffic on a green signal.

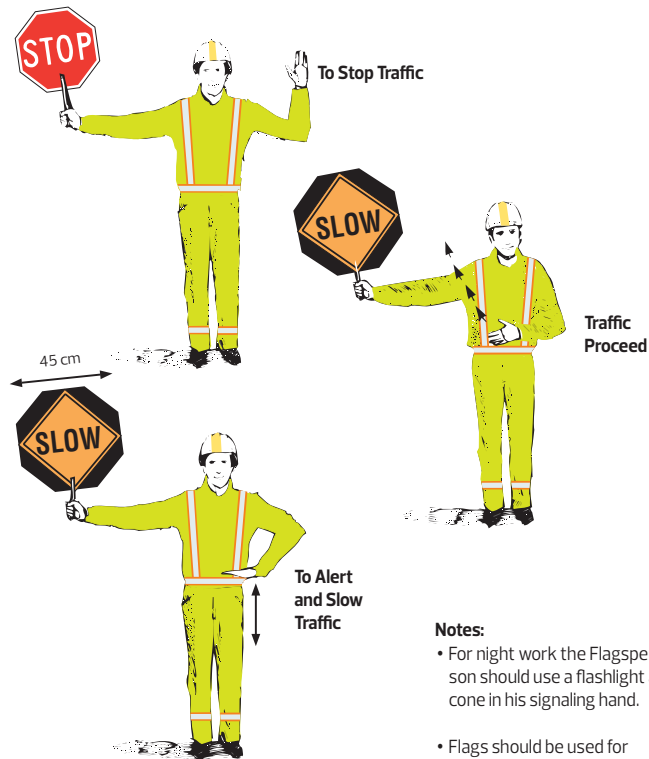

Positioning

- + Plan your route for escape.
- + Stand outside the lane of traffic.
- + Stand an appropriate distance from the work zone which will allow you to protect worksite personnel. This position will vary depending on the type of work that is taking place, the speed limit of the road and the weather conditions.
- + Contact the Edmonton Police Service at 780-423-4567 or 911 in the event of an emergency and inform them of what happened. If there have been any injuries request that an ambulance be dispatched. The Police will either dispatch a car or have you go to the nearest station to file a complaint.

Checklist

- + Is the "Traffic Control Person Ahead" sign up and far enough ahead of the flagperson?
- + Have the remainder of the traffic control devices been placed?
- + Have arrangements been made for necessary break times?
- + Is the equipment clean, visible and in good condition?
- + Has an escape route been planned? What about fellow workers?
- + Contact your company or department safety officer and inform him of the offence.
- + Make detailed notes of the incident as soon as possible while the incident is fresh in your memory. These notes will be useful if you are required to testify in court.
- + It will be up to you to file a complaint with the Police. Your department or company cannot do this for you; however your safety officer can accompany you to assist.
- + The Police will determine which charges can be laid and whether or not you have sufficient evidence based on the information that you provide to them. If there is sufficient evidence, the Police will lay the appropriate charges against the offender.

2.3 PROCEDURES FOR PROSECUTION OF VIOLATIONS AGAINST FLAGPERSON

In cases where motorists endanger or threaten flagpeople it is important that as much information as possible be recorded to prosecute the offending party. The Police cannot prosecute these individuals if they do not have sufficient evidence.

- + Gather the following information:
 - + Licence plate number
 - + Color and make of vehicle
 - + Description of driver
 - + Time of offence
 - + Names and phone numbers of witnesses

- + If the Police lay charges, you may be required to attend court to supply evidence.
- + If your company or department utilizes a near-miss or accident/ incident investigation report, complete as required.

2.4 TRAFFIC CONTROL SET-UP AND SIGN PLACEMENT

Temporary Traffic Control (TTC) devices shall be set up as described in the accepted Traffic Accommodation Plan. Consideration should be given as to where TTC devices are placed within the construction zone. Signs should be placed in a location that makes them easily visible while not obstructing pedestrians, cyclists and motorists.

Setup of Traffic Control Devices

- + All TTC devices must be in place prior to any work commencing and shall be set up to the satisfaction of Parks and Roads Services and according to the accepted Traffic Accommodation Plan.
- + When required, speed reductions shall be set up and maintained according to the 1.6 Work Zone Speed Reductions section of this manual. Speed reductions shall be submitted with your Traffic Accommodation Plan to Parks and Roads Services prior to being set up.
- + Signs shall be mounted approximately at right angles to and facing the flow of traffic.
- + Signs, cones, barricades, and other traffic control devices should initially be set up in order from upstream of the work to downstream.
- + Existing conflicting traffic control devices shall be covered or removed.
- + Signs and barricades shall be secured properly using sandbags.
- + Fire hydrants and water valves shall be accessible in the event of an emergency
- + Signal push buttons shall be readily accessible to pedestrians.

Sidewalks and Bike Infrastructure

- + Placing signs on sidewalks and bike infrastructure should be avoided where possible in order to not obstruct pedestrians and cyclists. Signs should be placed in the boulevard or furnishing zone adjacent to the roadway. If there is no boulevard or furnishing zone present, signs can be placed on available green space on the backside of the sidewalk. Signs should be placed outside of temporary pedestrian and cyclist facilities.

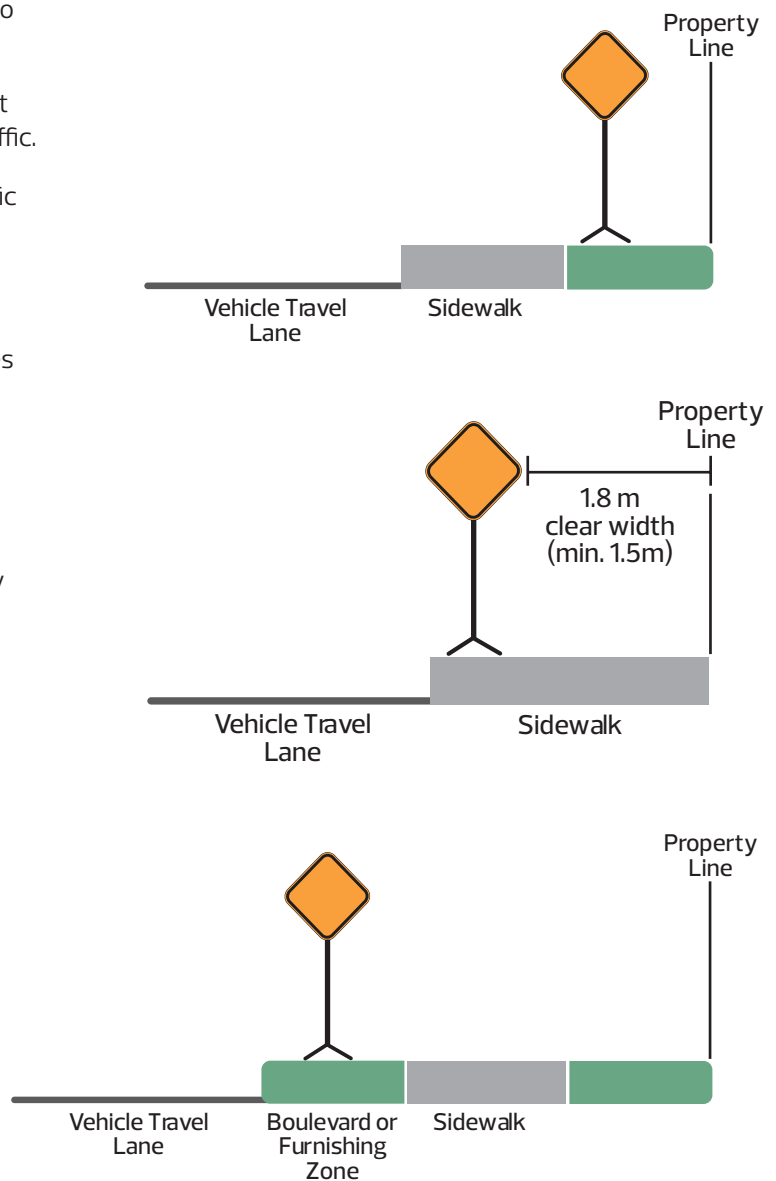

- + Where no other option exists, signs may be placed on a sidewalk or shared pathway as long as minimum widths are maintained. The 1.3 Pedestrian and Cyclist Obstructions section of this manual provides required widths for accommodating pedestrians and cyclists and should be used as a guide when identifying where to place temporary signage.
- + Consideration should be taken as to the anticipated number of pedestrians and cyclists using the sidewalk/bike infrastructure when setting up temporary traffic controls on a sidewalk or shared pathway. Locations with higher volumes should have a wider width than the minimum requirements to accommodate pedestrians and cyclists.

Vehicle Travel Lanes

- + Signs shall be placed in a manner that will not pose a hazard to drivers.
- + On roadways without barrier curbs, signs should be placed off the paved surface of the road where possible. Provided there is adequate shoulder width, signs may be placed on the shoulder if no other option exists.
- + Signs should be set far enough back from the paved surface as to not extend into the travel lanes. Provided there is adequate space, signs should be placed far enough back so as to not fall into the travel lane during windy/inclement weather.

Takedown of Signs and Barricades

- + Remove barricades against the flow of traffic, followed by removal of warning signs with the flow of traffic.
- + Signs and barricades should be removed promptly upon completion of work and the site being restored to an acceptable condition.

2.5 RECORD KEEPING

Records should be kept by the jobsite supervisor for any work which is interfering with traffic. These records are required in case of an incident at or near the worksite, which could result in legal action against the company performing the work and its workers.

Temporary Traffic Control (TTC) records should be made at the time of the initial set-up and should include either a sketch, photo, or video of the worksite traffic controls. For projects that remain in place for more than one day, traffic controls should be inspected at the end of day and a daily inspection record should be maintained.

Temporary Traffic Control Record Requirements

- + OSCAM Permit Number
- + Location
- + Weather Conditions
- + Start date and time of TTC Setup
- + Time of arrival on site (For detours set by others)
- + Site supervisor's contact information, including name, phone number, email and company
- + Who set up the TTC (E.g. Parks and Roads Services, third party, yourself)
- + Sketch, photo or video of the TTC devices
- + Time of removal of the TTC.

Daily Inspection Record Requirements

- + Time of arrival on site
- + Weather conditions (fog, rain, snow, etc.)
- + Condition of TTC at time of arrival

- + Road/Sidewalk/Bike Infrastructure surface conditions at start of day
- + Note of any damaged or missing TTC devices
- + Steps taken to correct deficiencies (E.g. Contacted Parks and Roads Services for replacement of damaged barricade or missing sign)
- + Time of departure and condition of TTC
- + Steps taken to secure the worksite

These records should be kept by anyone who is working in traffic. The records should either be kept in the site supervisor's daily log or in a standard record form.

2.6 MATERIAL STORAGE

Any temporary traffic control (TTC) devices that are not in use shall be stored in a manner that is safe towards pedestrian, cyclist, and vehicular traffic. TTC devices include but are not limited to barricades, temporary signs, electronic message boards/dynamic message signs/arrowboards, delineators, etc.

The following provides a guideline on proper TTC material storage and stockpiling within the road right-of-way:

- + At no time shall the storage of TTC material obstruct, impede, or interfere in any way with pedestrian or bike infrastructure, including both marked and unmarked crosswalks.
- + Material stockpiles are to maintain the sightlines of the public using the roadway including consideration of both marked and unmarked pedestrian crossings.
- + Signs and other traffic control devices that are not in use shall be stored in a safe manner that does not pose a hazard to the travelling public.
- + The materials should be stored in an area that can be safely accessed when they are required.
- + When storing materials behind a curb, they should be placed far enough back so as to not fall into sidewalks, bike infrastructure or vehicle travel lanes as a result of windy or inclement weather.
- + If sufficient space is not available to safely store unused TTC materials on site, the material should be removed from site and brought back when required as part of the temporary traffic control setup.
- + Signs stockpiled and not in use should be covered or facing away from traffic.

- + Materials should be stockpiled in an area that will not pose a hazard when covered in snow.
- + Materials should not be stockpiled on site outside of a reasonable time frame prior to the work commencing. Stockpiled materials should be removed promptly once the work has been completed.
- + Where no curb is present, a clear zone should be maintained within the road right-of-way when storing materials. The clear zone is an area measured perpendicular from the outside edge of the travelled lane that should be kept clear of stored materials at all times as shown below.

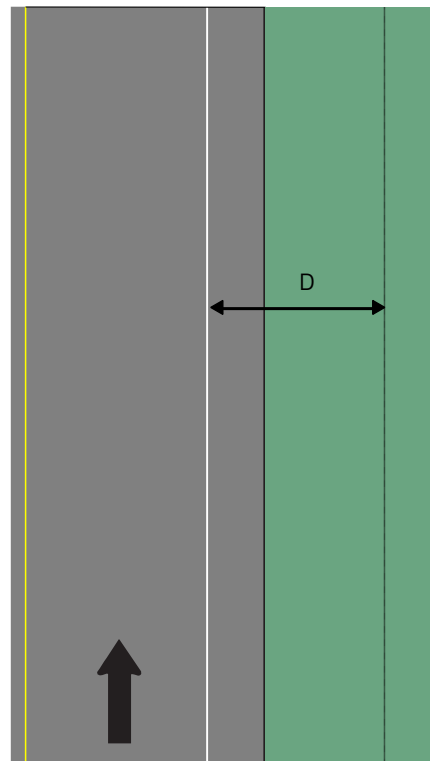

Notes:

1. Clear Zone Distance(D) is based on the posted speed limit in the work zone:

≥100km/hr, D = 9m

90km/hr, D = 7m

70–80km/hr, D = 5m

≤60km/hr, D = 4m

2. No curb adjacent to travel lane or shoulder

2.7 SITE UPKEEP

Once the Temporary Traffic Control (TTC) has been set up and work is proceeding, it is imperative to maintain the worksite reasonably clean and in good condition, especially for longer term projects.

The following guidelines in maintaining the work site:

- + Signs and other TTC devices shall be kept clean and visible when in use, and covered or turned away from traffic when not required. Examples of acceptable and unacceptable TTC devices are shown below:



- + All TTC device's should be located in the area identified in the Traffic Accommodation Plan and shall be secured appropriately (sandbags, etc.) in the event of adverse weather conditions.
- + Any traffic control materials not in use shall be stored in an appropriate location as identified in the 2.6 Material Storage section.
- + Sidewalks and bike infrastructure which are adjacent to the work area shall be kept clear of all debris and tripping hazards. This includes temporary pedestrian and bicyclist accommodations. Site debris such as sand, gravel, and tracked mud shall be removed promptly as these will pose a hazard to individuals walking and cycling. Snow and ice buildup shall be removed or controlled in a manner that provides a safe walking and cycling surface. Examples of acceptable and unacceptable pedestrian/cyclist facilities are shown below:
- + Proper drainage shall be maintained in order to prevent ponding especially in pedestrian and cyclist areas.
- + Ensure that there is adequate lighting. Sites which require the use of overhead hoarding should have appropriate lighting within the pedestrian/cyclist areas.
- + Ensure signs, cones, channelization devices and other TTC devices are in their proper locations at the start and end of each day.
- + Keep a copy of the OSCAM permit and Traffic Accommodation Plan on site. The OSCAM permit should be publicly displayed.
- + Upon completion of the work, the worksite shall be restored to a condition that is equal to or better than prior to the work starting



2.8 SUMMARY CHECKLIST

Requirements for Set-Up, Maintenance and Takedown

Setup

- All work areas are properly signed and barricaded to the satisfaction of Parks and Roads Services and as per the submitted Traffic Accommodation Plan.
- The prime contractor or the job site supervisor will arrange, maintain and monitor the Temporary Traffic Control.
- All temporary traffic control devices are properly stabilized and not placed on sidewalks or bike infrastructure
- Flagpeople are properly trained and certified.
- Fire hydrants and water valves are accessible in the event of an emergency
- Private vehicles are not parked on work sites or the sites of temporary parking bans.
- Debris is cleared promptly from all paths and road surfaces and proper drainage is being maintained.
- Adequate lighting is being maintained throughout the duration of the project .
- OSCAM permit is current and start and end dates are correct.

Takedown

- Work site has been restored to a condition equal to or better than it was prior to the work occurring.
- All temporary traffic control devices have been removed upon completion of the work and the site has been properly restored.

Maintenance and Upkeep

- Traffic control materials are stored in a safe manner that does not obstruct pedestrians, cyclists, and motor vehicles and does not present a hazard to the travelling public
- Traffic control devices are clean, visible, and in good condition for the duration they are being used. They have been inspected and records are kept daily to make sure they are upright, visible, and in their proper locations.
- When traffic lanes are required before the work is finished, trenches and small excavation sites shall be bridged with steel plates. All unnecessary temporary traffic control equipment and devices shall be removed from the road or turned away from traffic immediately.

3.0 TYPICAL DRAWINGS

3.1 BACKGROUND

This section of the Manual of Temporary Traffic Control contains examples of traffic situations where the use of signs, barricades, protective devices, cones and/or flagperson are necessary. The examples shown in the next few pages are not an overall guide to every possible traffic situation where signs or other devices are needed. Rather, the illustrations show a few of the more common everyday situations and they are to be used as a guide only. Common sense will determine the best action to be taken.

Remember that the protection of the public and the workers at any worksite can often depend on the protective equipment used to alert traffic to any obstructions. Included in the following pages are examples of the following situations:

- + Series A: Complete and Partial Road Closures
- + Series B: Flagging and Short Duration Operations
- + Series C: Pedestrian and Cyclist Accommodations

3.2 SERIES A: COMPLETE AND PARTIAL ROAD CLOSURES

This section refers to those situations where complete or partial closures of a road are necessary for the protection of the public or workers. Different ways of closing a road may be used. These are illustrated in the sketches following. In those cases where a different route for traffic is not obvious, detour signs may be required.

Examples:

- + A1 – Back Lane Closure
- + A2 – Residential Road Closure
- + A3 – Yield to Oncoming Traffic
- + A4 – Single Left Lane Closure: Parking Permitted
- + A5 – Single Lane Closure: No Parking Permitted
- + A6 – Two Lane Closure: Traffic Split



A1- Back Lane Closure

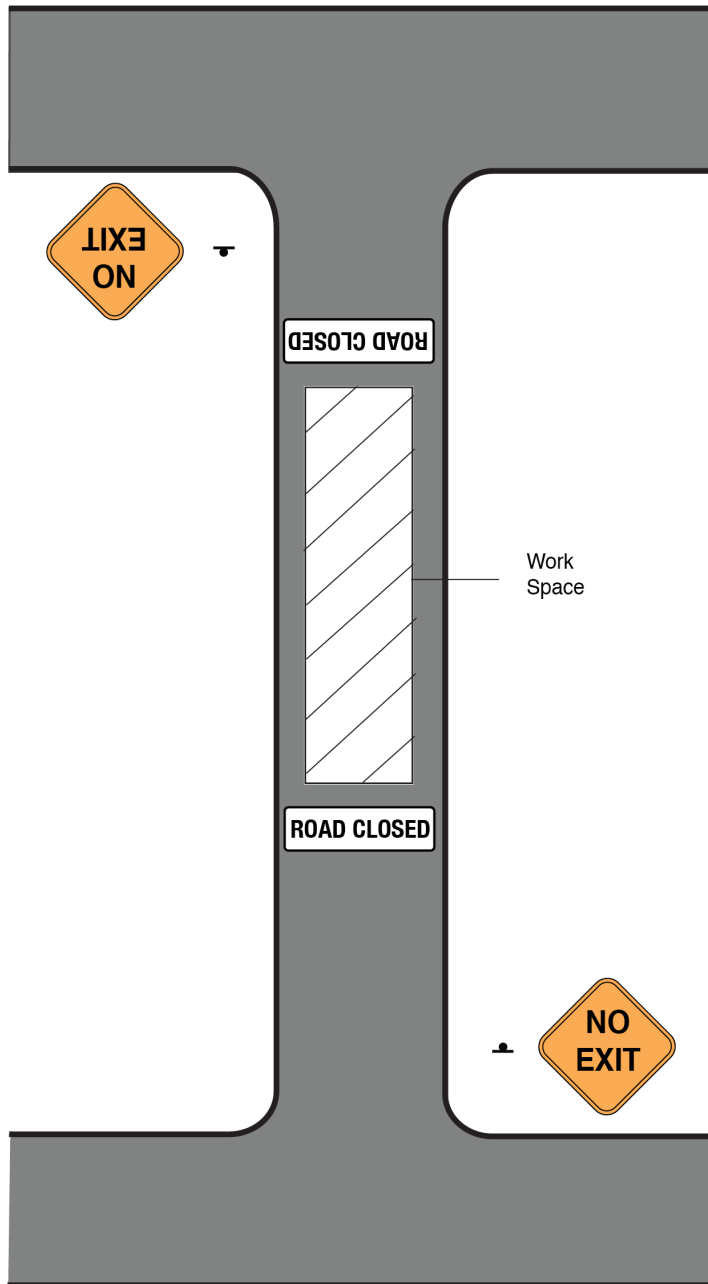

Table 3
Placement of Temporary Traffic Control Devices

V (KM/H)	A (M)	L (M)	B (M)	D (M)
≤50	50	30	35	8
60	50	40	45	12
70	75	60	50	15
80	100	80	60	15
90	100	105	65	18
100	125	125	70	18
110	125	145	75	20

WHERE:

V = Posted Speed Limit

A = Spacing between signs

L = Length of Taper

B = Length of Longitudinal Buffer Space

D = Spacing between Delineation Devices

A2- Residential Road Closure

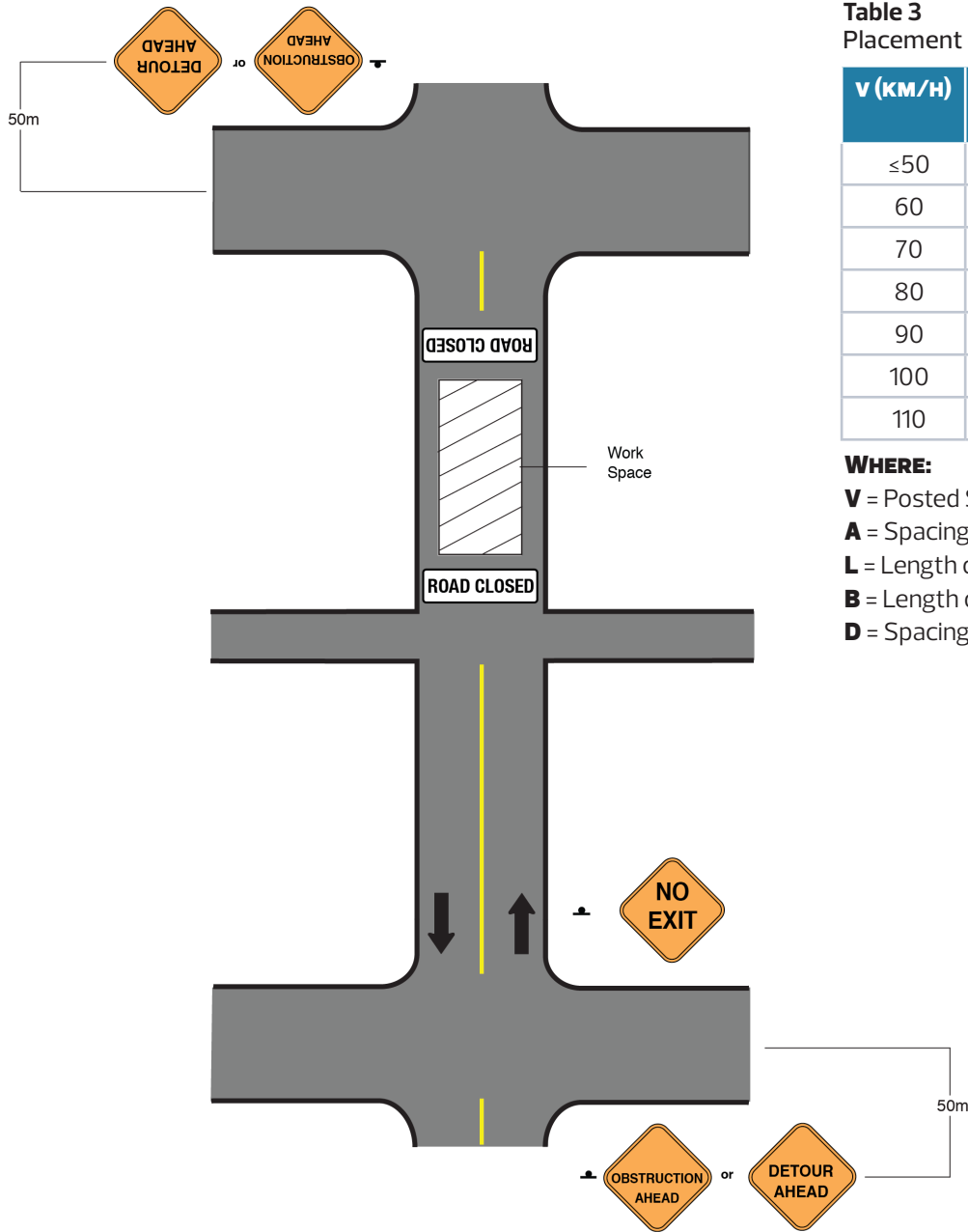

Table 3
Placement of Temporary Traffic Control Devices

V (KM/H)	A (M)	L (M)	B (M)	D (M)
≤50	50	30	35	8
60	50	40	45	12
70	75	60	50	15
80	100	80	60	15
90	100	105	65	18
100	125	125	70	18
110	125	145	75	20

WHERE:

V = Posted Speed Limit

A = Spacing between signs

L = Length of Taper

B = Length of Longitudinal Buffer Space

D = Spacing between Delineation Devices

A3- Yield to Oncoming Traffic

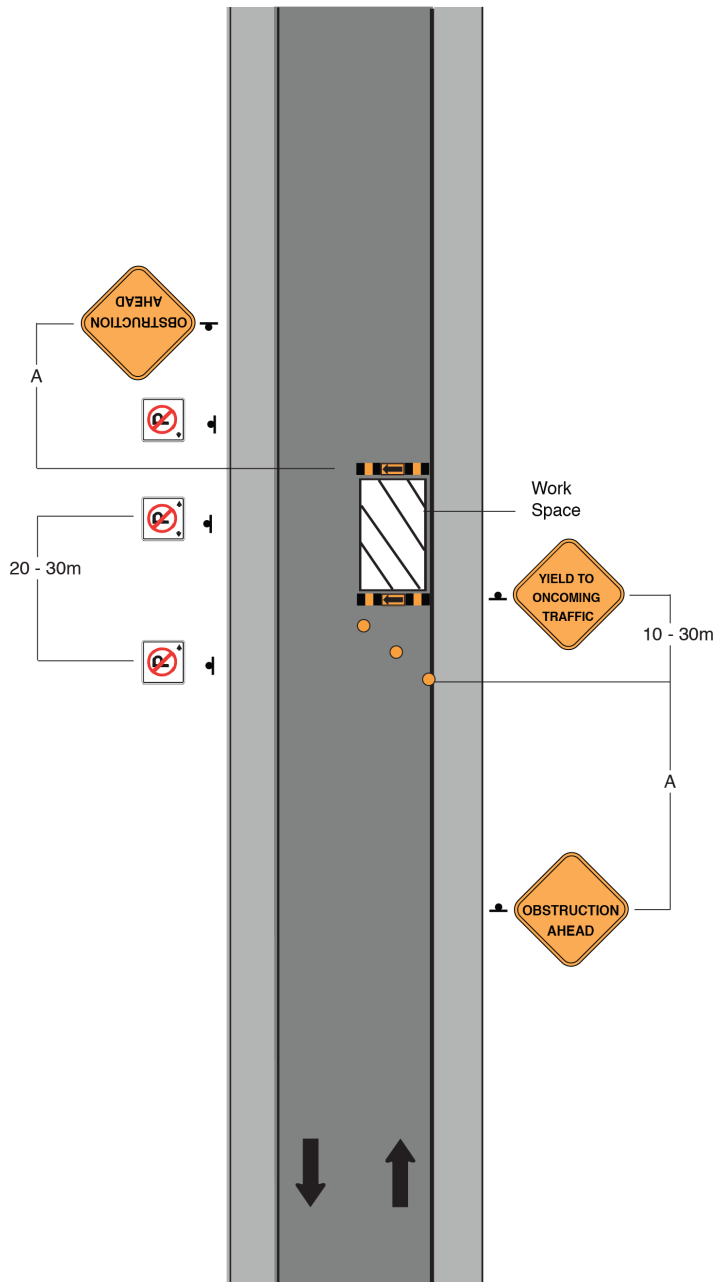

Table 3
Placement of Temporary Traffic Control Devices

V (KM/H)	A (M)	L (M)	B (M)	D (M)
≤50	50	30	35	8
60	50	40	45	12
70	75	60	50	15
80	100	80	60	15
90	100	105	65	18
100	125	125	70	18
110	125	145	75	20

WHERE:

V = Posted Speed Limit

A = Spacing between signs

L = Length of Taper

B = Length of Longitudinal Buffer Space

D = Spacing between Delineation Devices

A4- Single Left Lane Closure: Parking Permitted

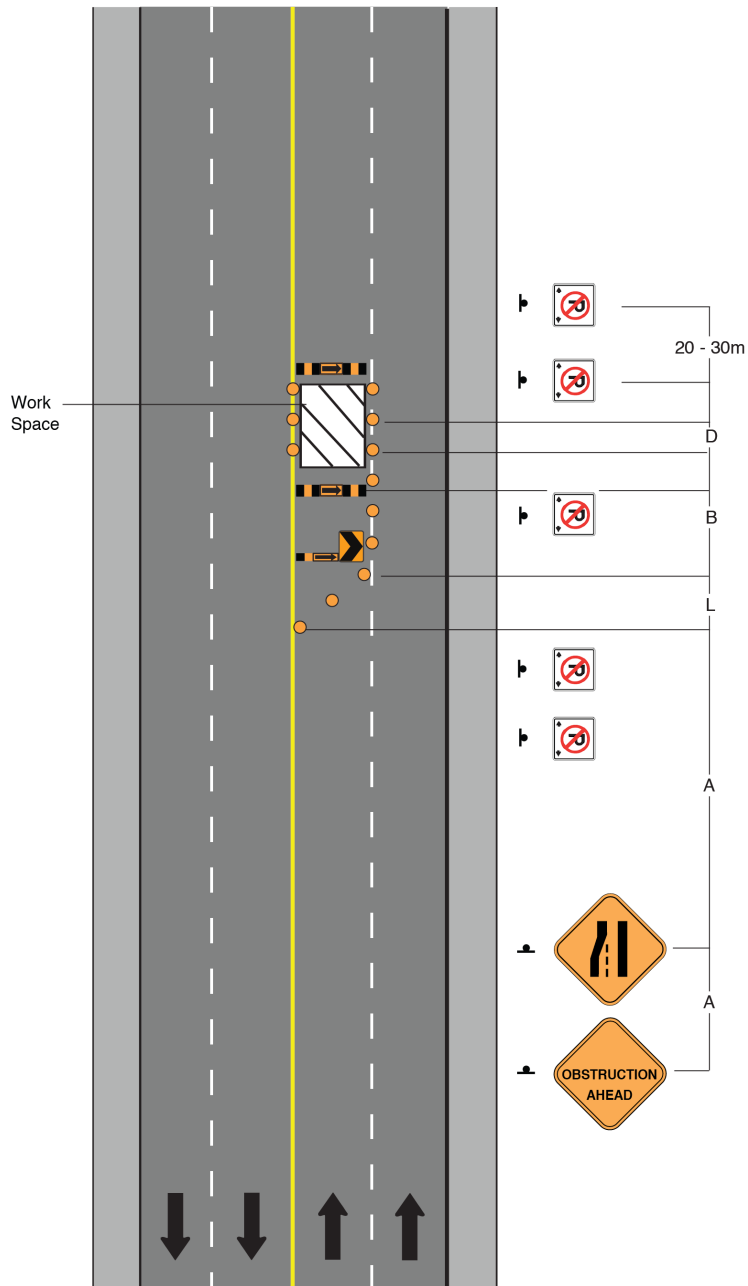

Table 3
Placement of Temporary Traffic Control Devices

V (KM/H)	A (M)	L (M)	B (M)	D (M)
≤50	50	30	35	8
60	50	40	45	12
70	75	60	50	15
80	100	80	60	15
90	100	105	65	18
100	125	125	70	18
110	125	145	75	20

WHERE:

V = Posted Speed Limit

A = Spacing between signs

L = Length of Taper

B = Length of Longitudinal Buffer Space

D = Spacing between Delineation Devices

A5- Single Right Lane Closure:
No Parking Permitted

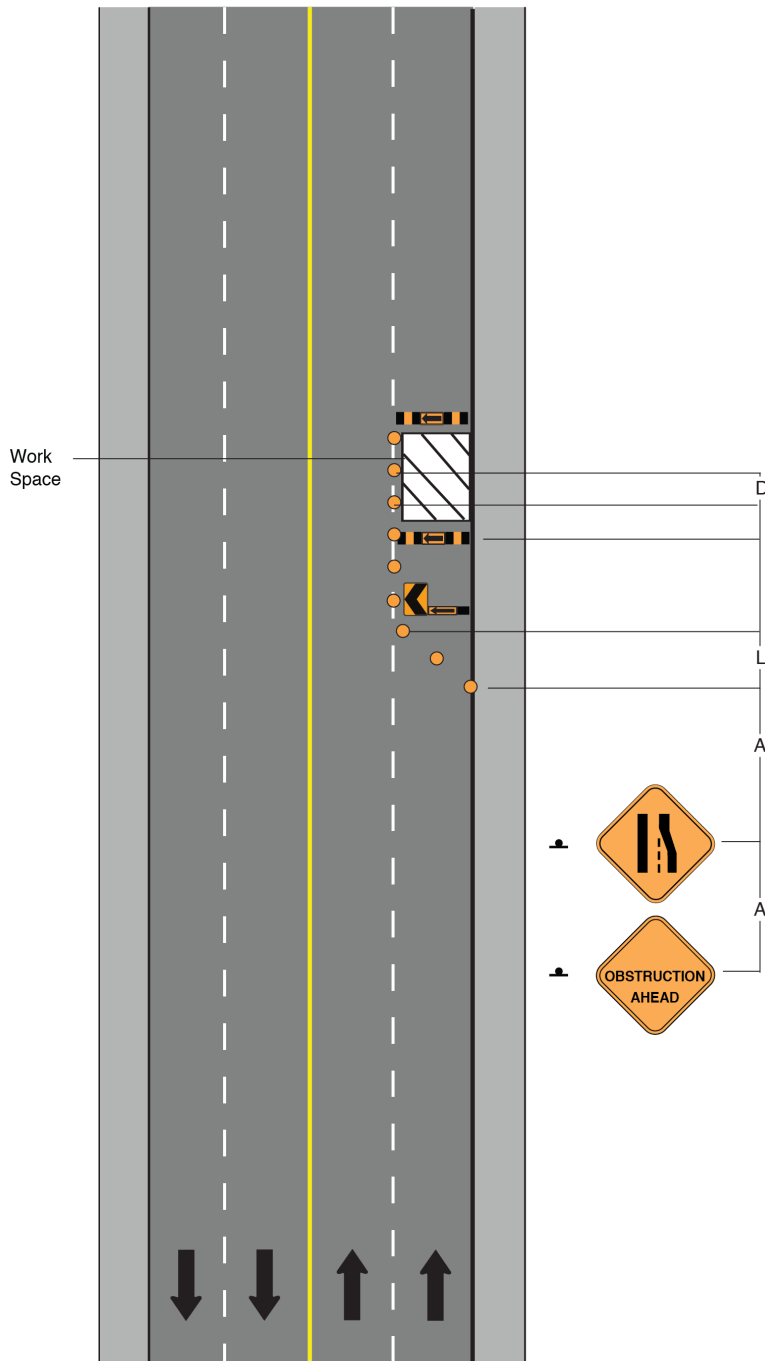

Table 3
Placement of Temporary Traffic Control Devices

V (KM/H)	A (M)	L (M)	B (M)	D (M)
≤50	50	30	35	8
60	50	40	45	12
70	75	60	50	15
80	100	80	60	15
90	100	105	65	18
100	125	125	70	18
110	125	145	75	20

WHERE:

V = Posted Speed Limit

A = Spacing between signs

L = Length of Taper

B = Length of Longitudinal Buffer Space

D = Spacing between Delineation Devices

A6- Two Left Lane Closure:
Traffic Split

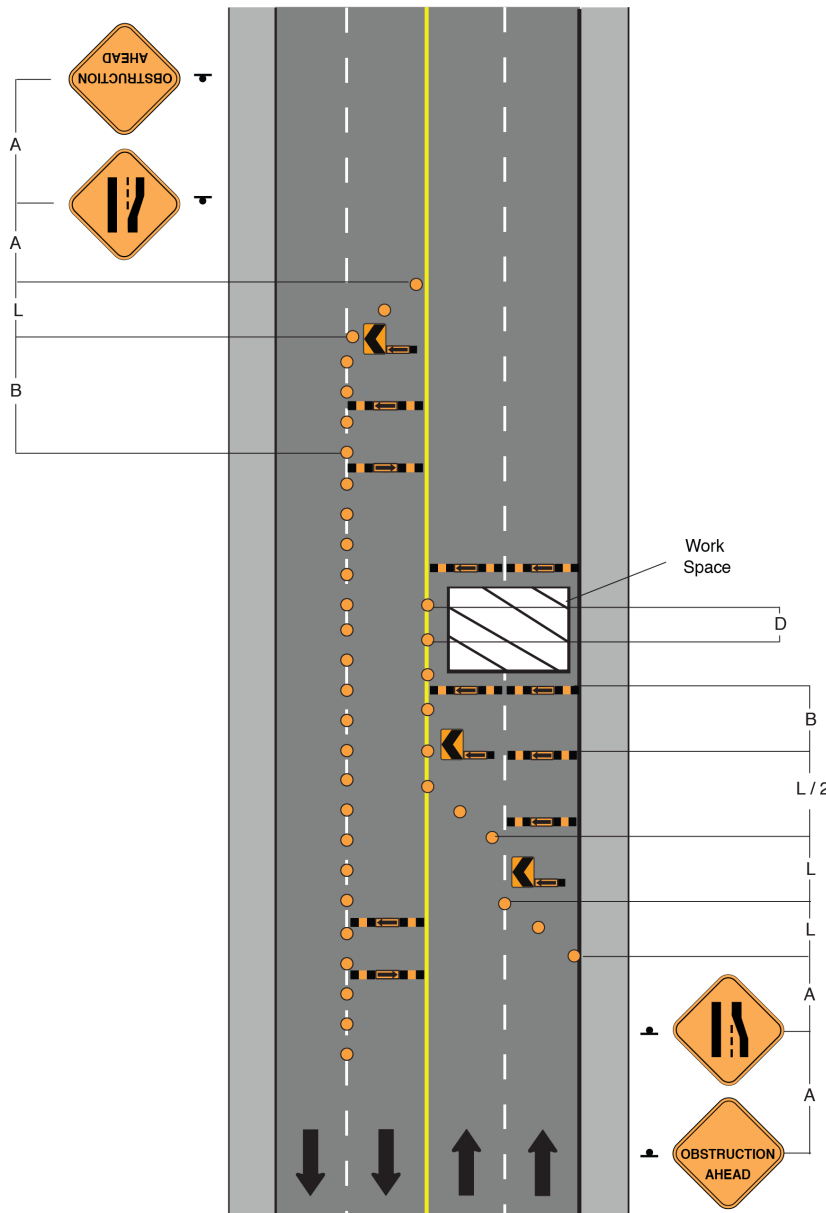

Table 3
Placement of Temporary Traffic Control Devices

V (KM/H)	A (M)	L (M)	B (M)	D (M)
≤50	50	30	35	8
60	50	40	45	12
70	75	60	50	15
80	100	80	60	15
90	100	105	65	18
100	125	125	70	18
110	125	145	75	20

WHERE:

V = Posted Speed Limit

A = Spacing between signs

L = Length of Taper

B = Length of Longitudinal Buffer Space

D = Spacing between Delineation Devices

3.3 SERIES B: FLAGGING AND SHORT DURATION OPERATIONS

Flagging and short duration operations can occur under a variety of situations. Included in the following pages are examples of the following situations:

- + B1 – Two Way Flagging Operation
- + B2 – Flagging: Closure Short Duration
- + B3 – Short Duration: Utility Operation
- + B4 – Short Duration: Work at Signalized Intersection

For short duration operations affecting pedestrians and cyclists, see Series C.

B1 - Two-Way Flagging Operation

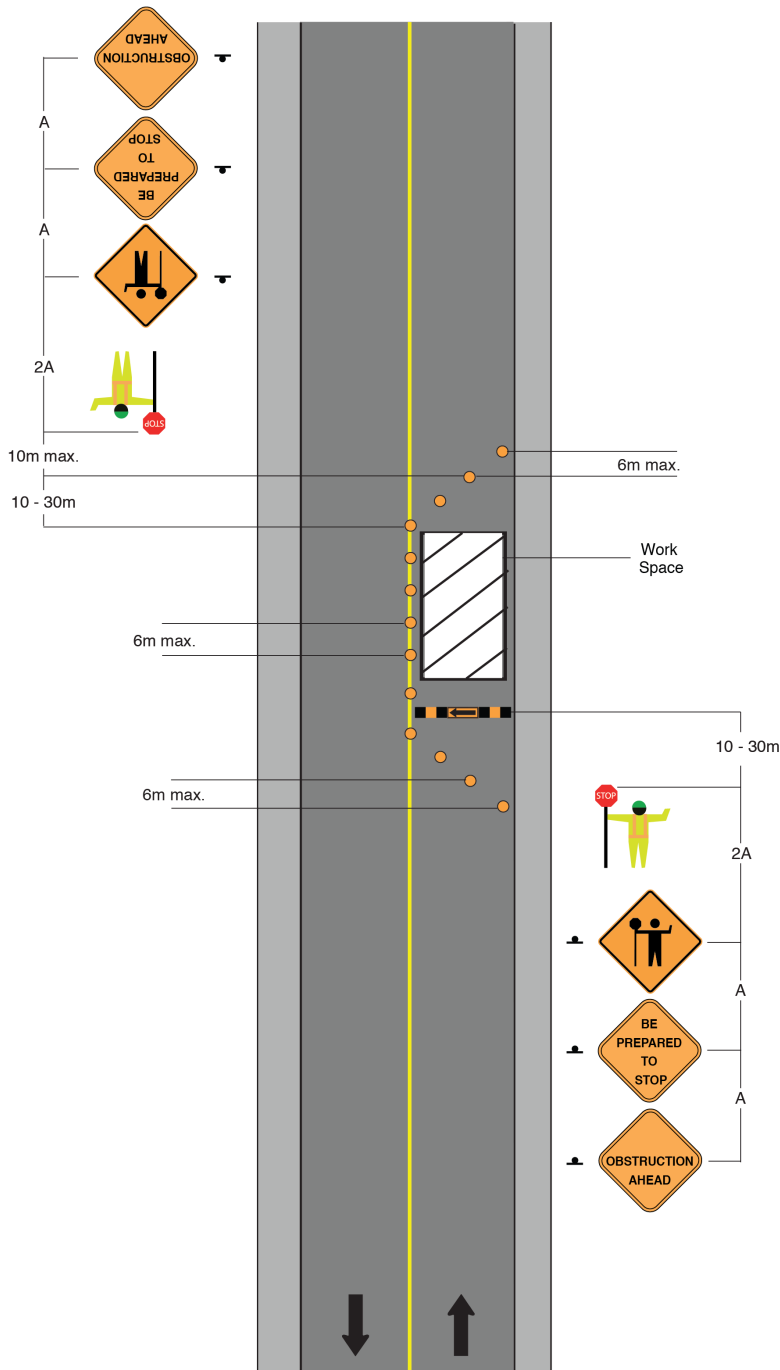

Table 3
Placement of Temporary Traffic Control Devices

V (KM/H)	A (M)	L (M)	B (M)	D (M)
≤50	50	30	35	8
60	50	40	45	12
70	75	60	50	15
80	100	80	60	15
90	100	105	65	18
100	125	125	70	18
110	125	145	75	20

WHERE:

V = Posted Speed Limit

A = Spacing between signs

L = Length of Taper

B = Length of Longitudinal Buffer Space

D = Spacing between Delineation Devices

B2 – Flagging:
Closure Short Duration

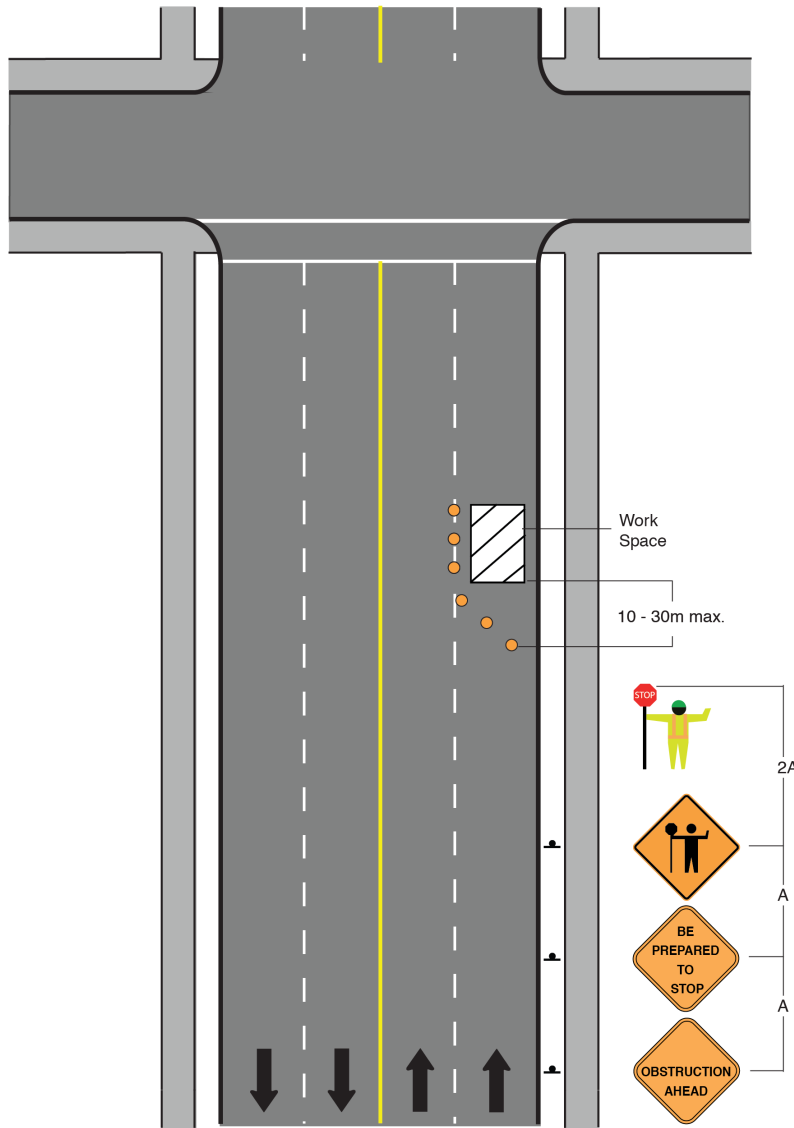

Table 3
Placement of Temporary Traffic Control Devices

V (KM/H)	A (M)	L (M)	B (M)	D (M)
≤50	50	30	35	8
60	50	40	45	12
70	75	60	50	15
80	100	80	60	15
90	100	105	65	18
100	125	125	70	18
110	125	145	75	20

WHERE:

V = Posted Speed Limit

A = Spacing between signs

L = Length of Taper

B = Length of Longitudinal Buffer Space

D = Spacing between Delineation Devices

B3 – Utility Operation
(e.g. – manholes or pothole repairs, etc.)

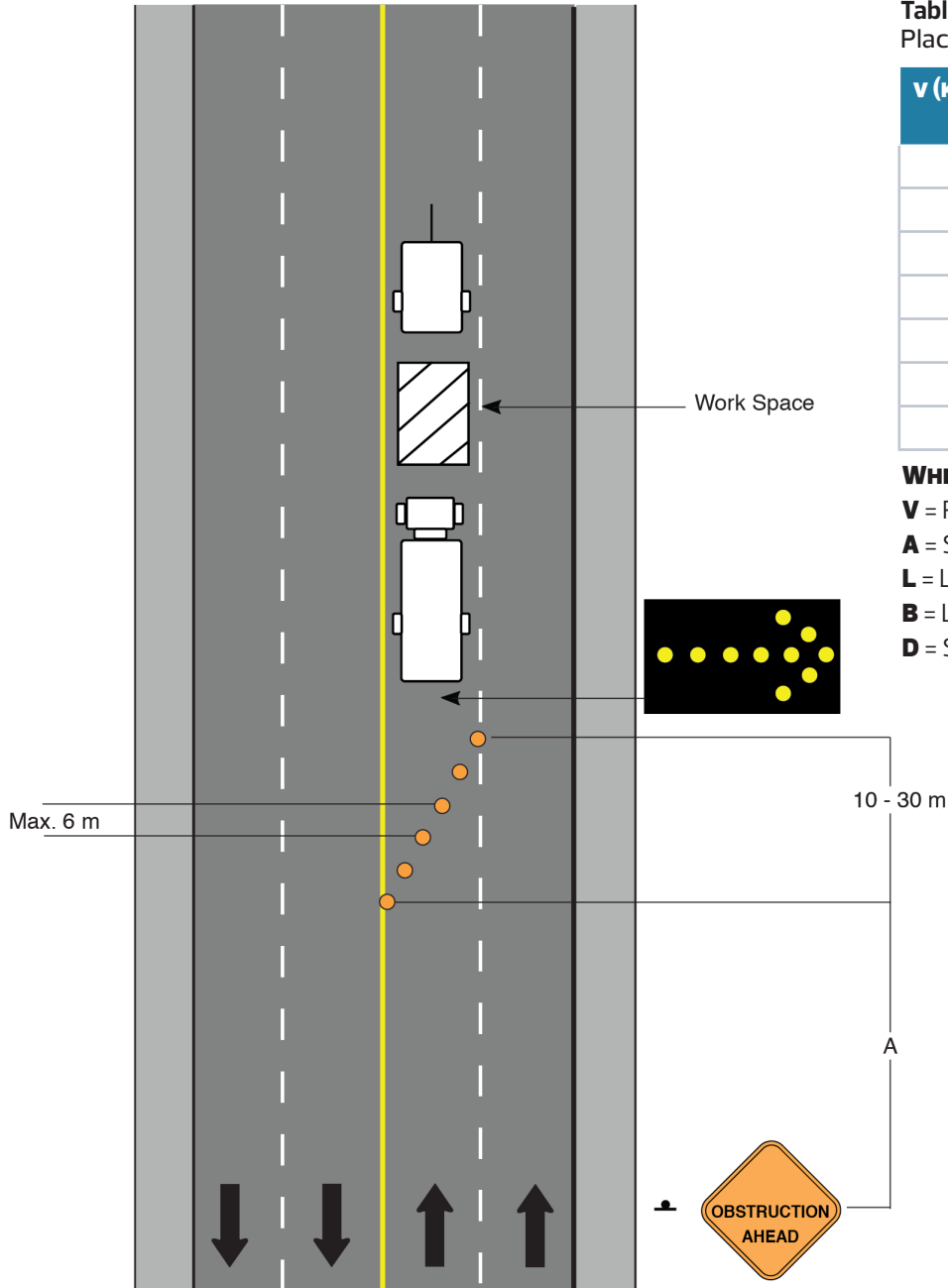

Table 3
Placement of Temporary Traffic Control Devices

V (KM/H)	A (M)	L (M)	B (M)	D (M)
≤50	50	30	35	8
60	50	40	45	12
70	75	60	50	15
80	100	80	60	15
90	100	105	65	18
100	125	125	70	18
110	125	145	75	20

WHERE:

V = Posted Speed Limit

A = Spacing between signs

L = Length of Taper

B = Length of Longitudinal Buffer Space

D = Spacing between Delineation Devices

B4 – Short Duration Work at Intersection

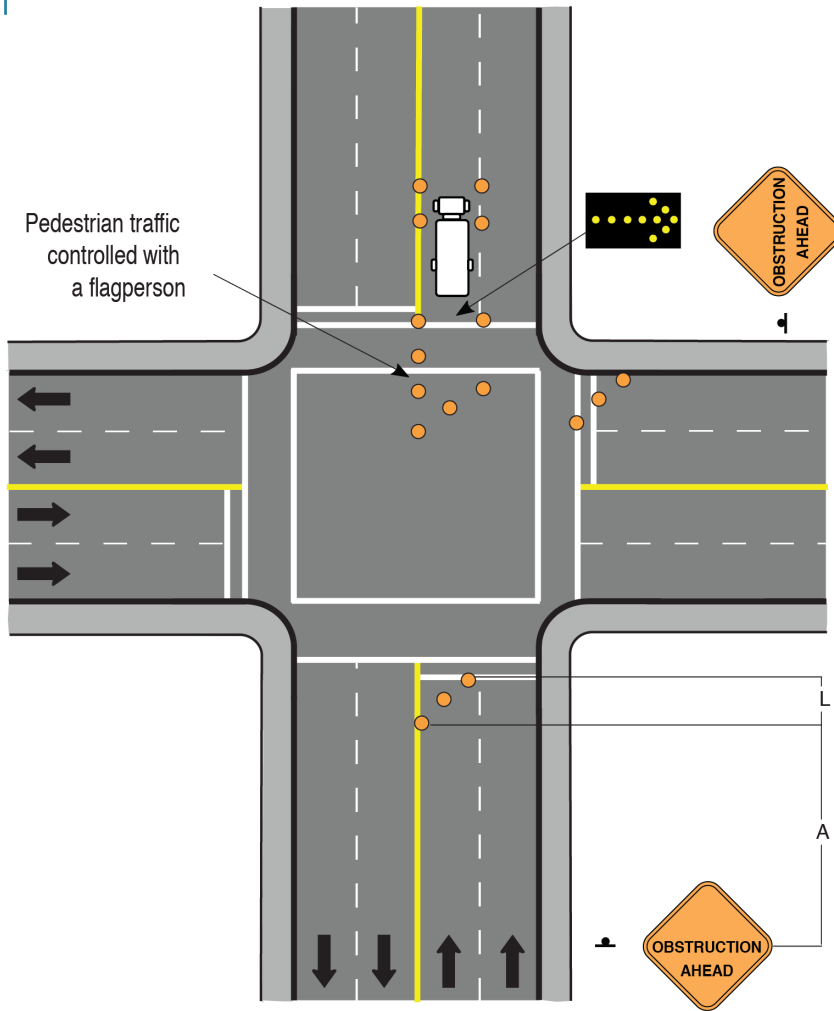

Table 3
Placement of Temporary Traffic Control Devices

V (KM/H)	A (M)	L (M)	B (M)	D (M)
≤50	50	30	35	8
60	50	40	45	12
70	75	60	50	15
80	100	80	60	15
90	100	105	65	18
100	125	125	70	18
110	125	145	75	20

WHERE:

- V** = Posted Speed Limit
- A** = Spacing between signs
- L** = Length of Taper
- B** = Length of Longitudinal Buffer Space
- D** = Spacing between Delineation Devices

3.4 SERIES C: PEDESTRIAN AND CYCLIST ACCOMMODATIONS

This section refers to those situations where pedestrians and/or cyclists need to be accommodated through work zones for short duration and long duration projects. Flagpeople may also be used in a few situations to direct pedestrians and cyclists for short duration projects. Refer to the 1.3 Pedestrian and Cyclist Obstructions for guidance on selecting the appropriate traffic accommodation. Below are examples of some typical traffic accommodation scenarios when impacting pedestrians and cyclists:



- + C1 – Partial Sidewalk Closure
- + C2 – Sidewalk Closed Midblock: Temporary Sidewalk
- + C3– Sidewalk Closed Midblock: Pedestrians use Parallel Facility
- + C4– Sidewalks Closed at Intersection: Temporary Sidewalks
- + C5– Sidewalks Closed at Intersection: Pedestrians Use Parallel Facilities
- + C6 – Two-Way Bike Lane Partial Closure: Single Lane Alternating Bike Traffic
- + C7– Bike Lane Closed: Temporary Bike Lane using Lateral Shift
- + C8 – Bike Lane Closed: Temporary Bike Lane
- + C9– Bike Lane Closed: Cyclists Detour
- + C10–Bike Lane Closed: Cyclists Dismount and Walk
- + C11– Sidewalk and Bike Lane Closed: Temporary Sidewalk and Bike Lane
- + C12– Sidewalk and Bike Lane Closed: Temporary Shared Pathway
- + C13– Sidewalk Closed: Temporary Shared Pathway in Bike Facility

C1- Partial Sidewalk Closure

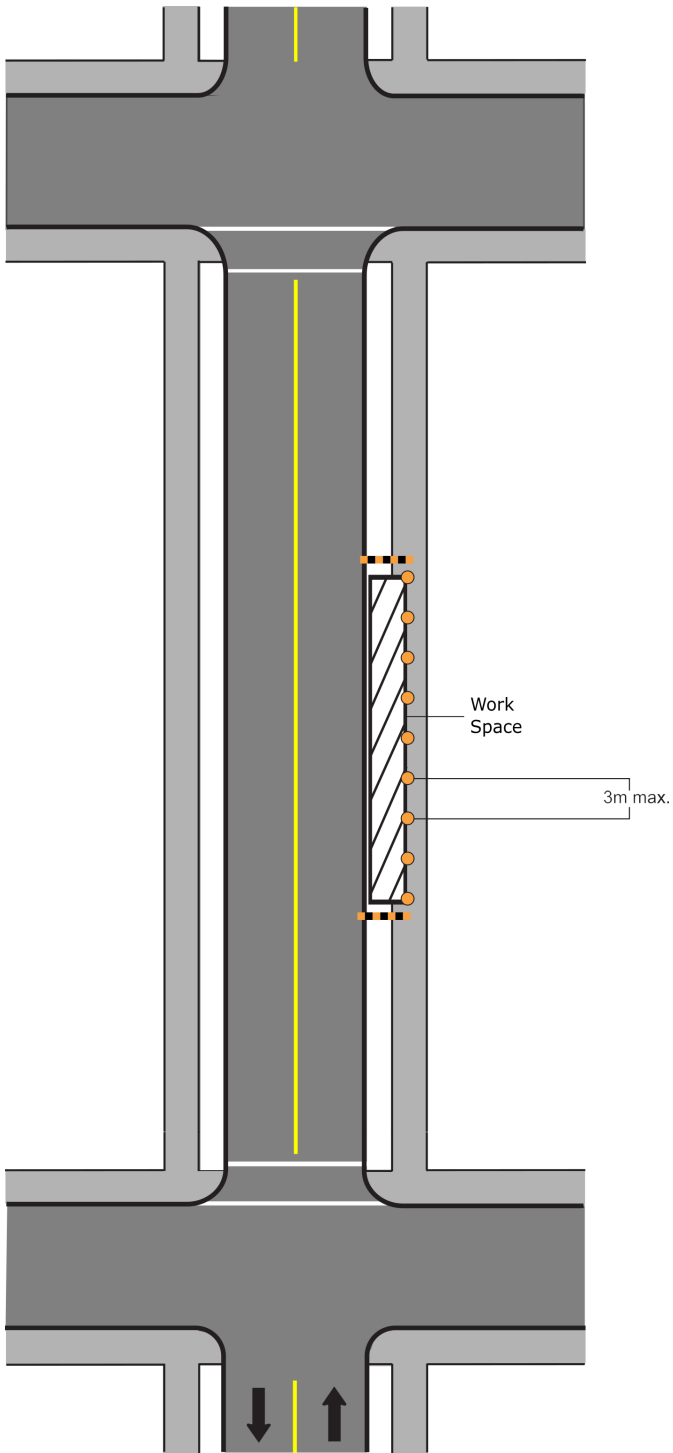

Table 3
Placement of Temporary Traffic Control Devices

V (KM/H)	A (M)	L (M)	B (M)	D (M)
≤50	50	30	35	8
60	50	40	45	12
70	75	60	50	15
80	100	80	60	15
90	100	105	65	18
100	125	125	70	18
110	125	145	75	20

WHERE:

V = Posted Speed Limit

A = Spacing between signs

L = Length of Taper

B = Length of Longitudinal Buffer Space

D = Spacing between Delineation Devices

C2 – Sidewalk Closed Midblock:
Temporary Sidewalk

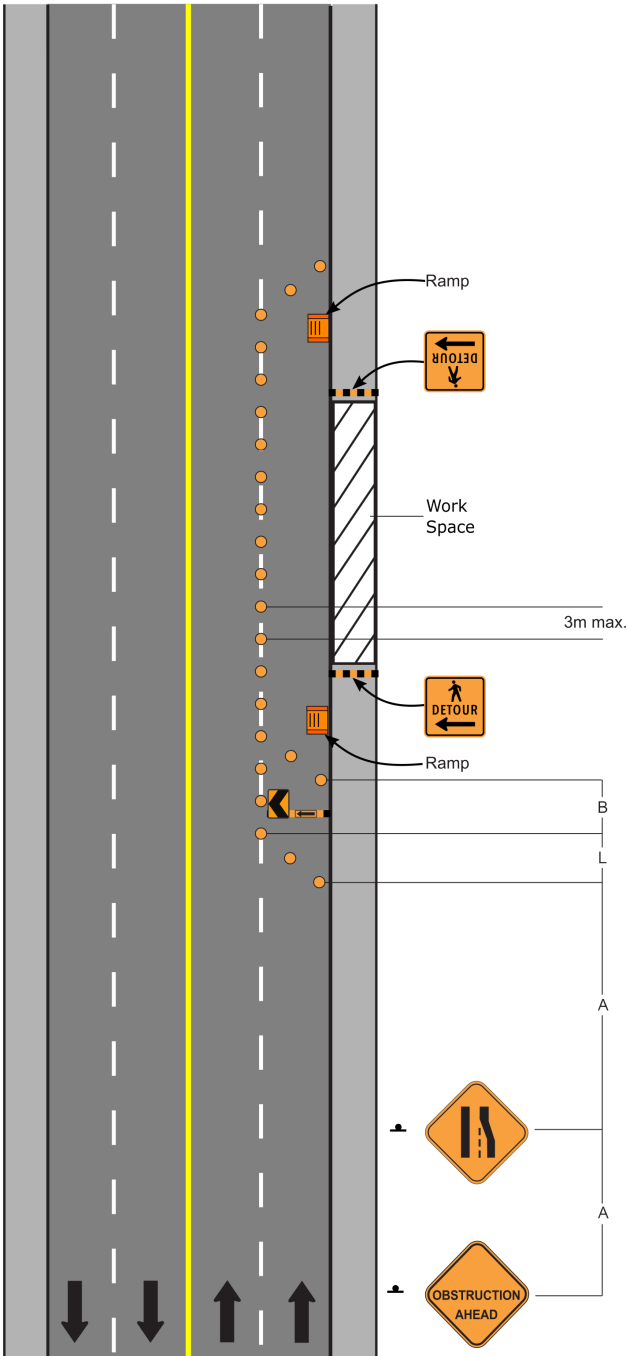

Table 3
Placement of Temporary Traffic Control Devices

V (KM/H)	A (M)	L (M)	B (M)	D (M)
≤50	50	30	35	8
60	50	40	45	12
70	75	60	50	15
80	100	80	60	15
90	100	105	65	18
100	125	125	70	18
110	125	145	75	20

WHERE:

V = Posted Speed Limit

A = Spacing between signs

L = Length of Taper

B = Length of Longitudinal Buffer Space

D = Spacing between Delineation Devices

C3- Sidewalk Closed Midblock:
Pedestrians use Parallel Facility

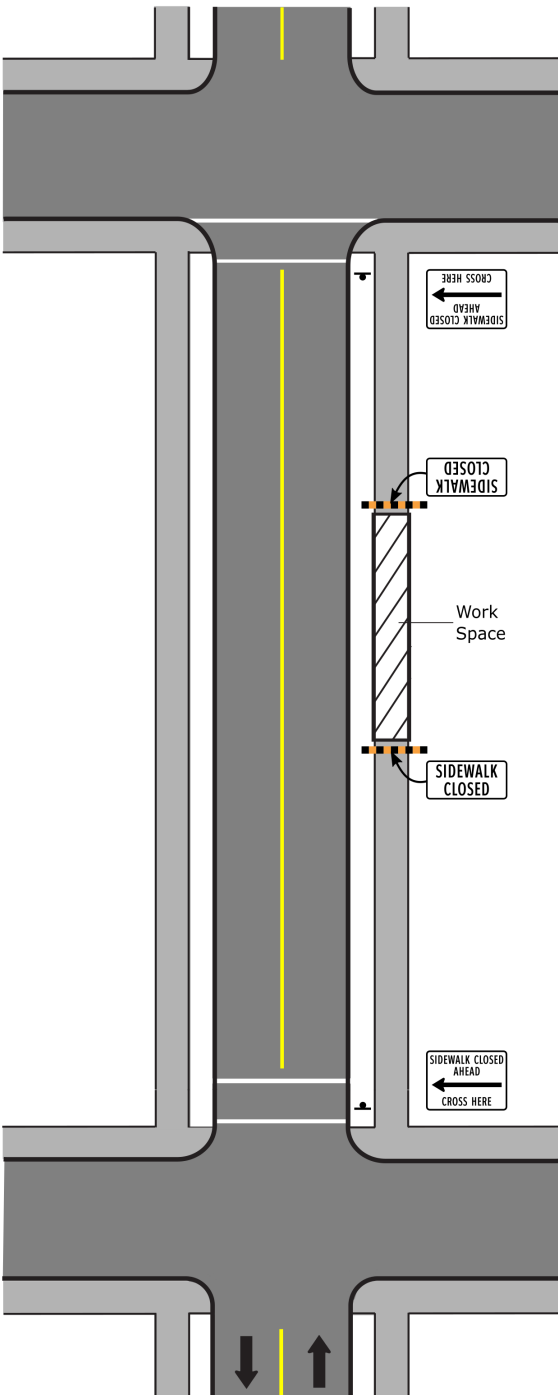

Table 3
Placement of Temporary Traffic Control Devices

V (KM/H)	A (M)	L (M)	B (M)	D (M)
≤50	50	30	35	8
60	50	40	45	12
70	75	60	50	15
80	100	80	60	15
90	100	105	65	18
100	125	125	70	18
110	125	145	75	20

WHERE:

V = Posted Speed Limit

A = Spacing between signs

L = Length of Taper

B = Length of Longitudinal Buffer Space

D = Spacing between Delineation Devices

C4 – Sidewalks Closed at Intersection:
Temporary Sidewalks

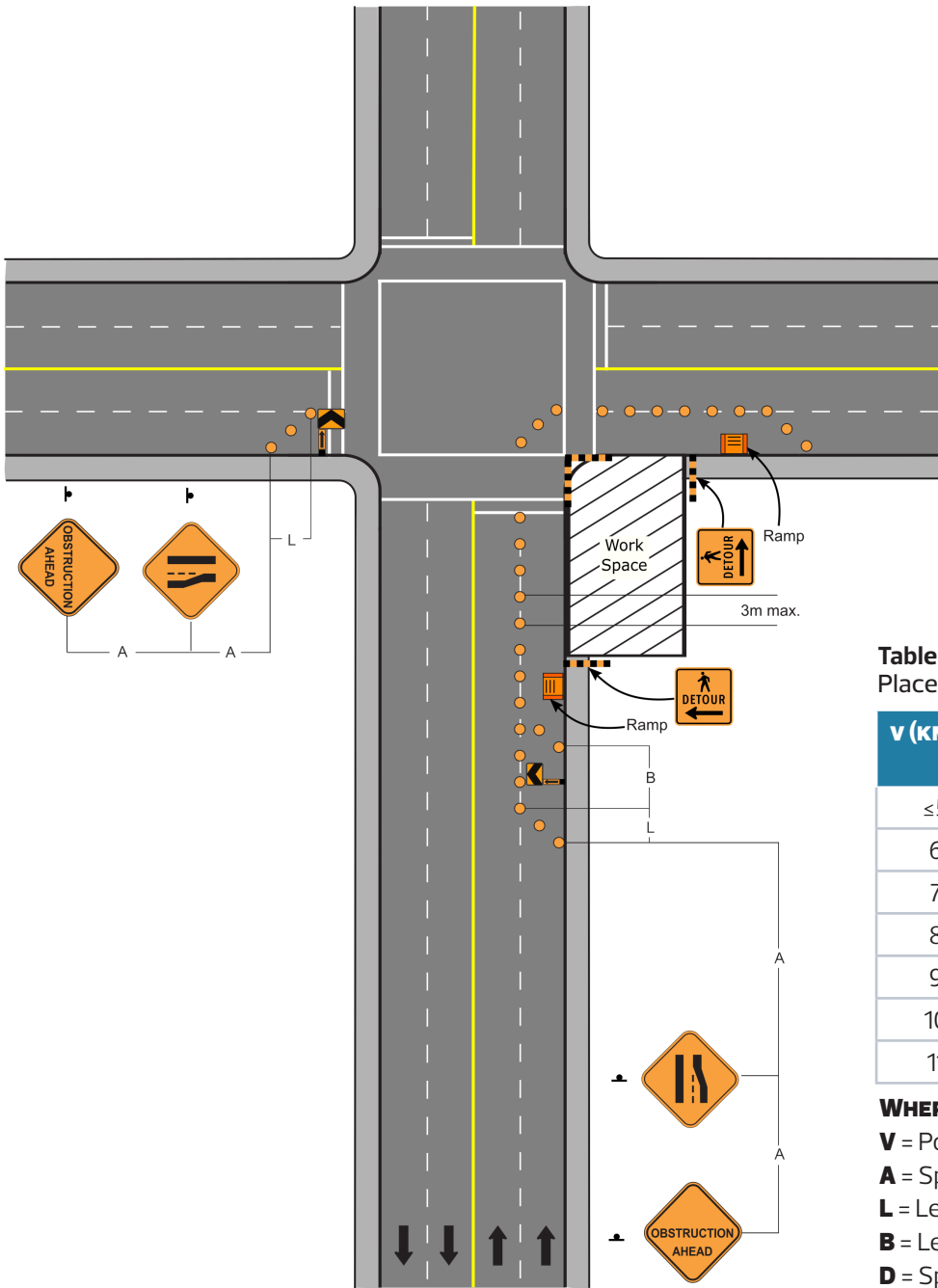

Table 3
Placement of Temporary Traffic Control Devices

V (KM/H)	A (M)	L (M)	B (M)	D (M)
≤50	50	30	35	8
60	50	40	45	12
70	75	60	50	15
80	100	80	60	15
90	100	105	65	18
100	125	125	70	18
110	125	145	75	20

WHERE:

- V** = Posted Speed Limit
- A** = Spacing between signs
- L** = Length of Taper
- B** = Length of Longitudinal Buffer Space
- D** = Spacing between Delineation Devices

C5- Sidewalks Closed at Intersection:
Pedestrians Use Parallel Facilities

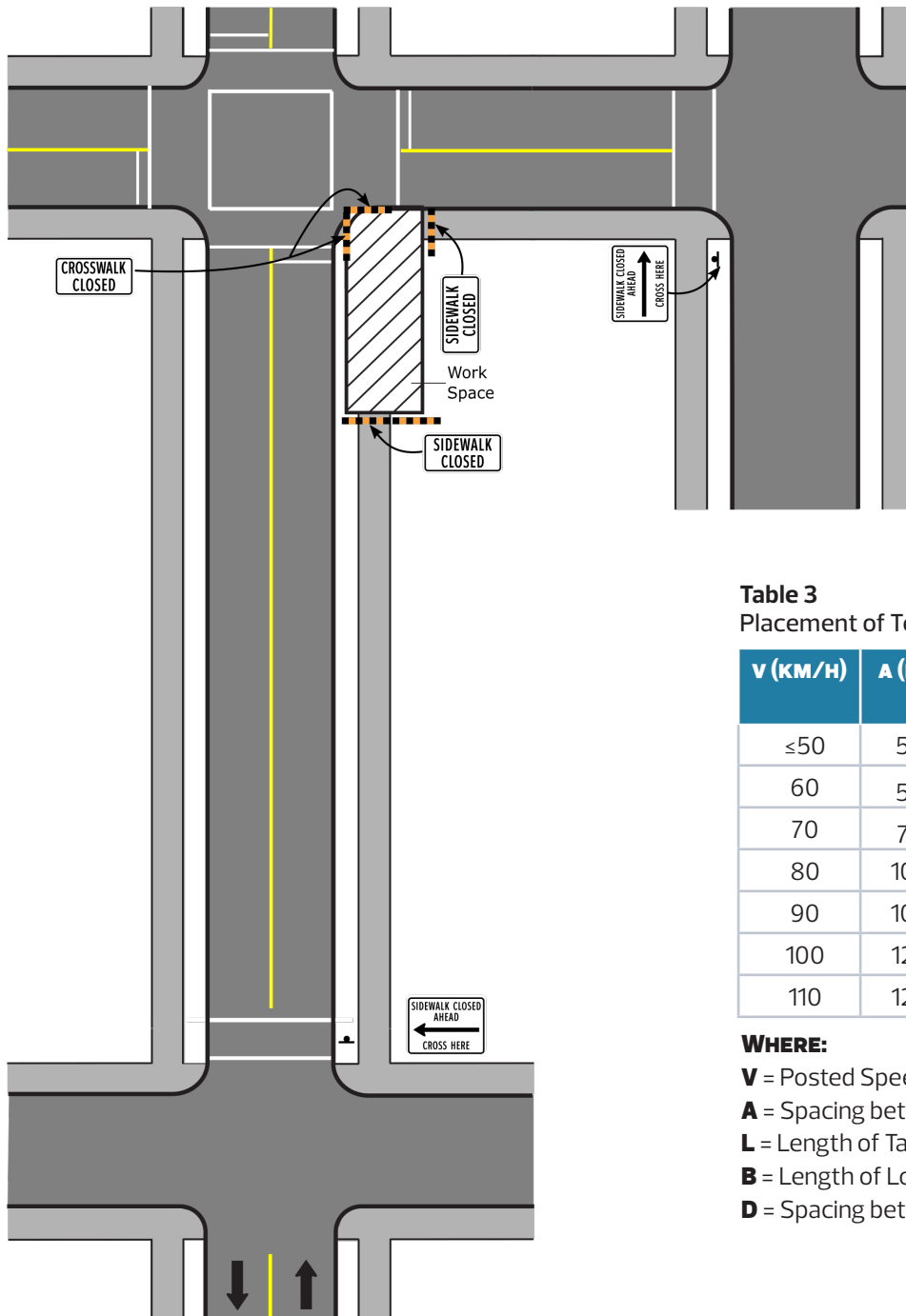

Table 3
Placement of Temporary Traffic Control Devices

V (KM/H)	A (M)	L (M)	B (M)	D (M)
≤50	50	30	35	8
60	50	40	45	12
70	75	60	50	15
80	100	80	60	15
90	100	105	65	18
100	125	125	70	18
110	125	145	75	20

WHERE:

V = Posted Speed Limit

A = Spacing between signs

L = Length of Taper

B = Length of Longitudinal Buffer Space

D = Spacing between Delineation Devices

C6 – Two-way Bike Lane Partial Closure:
Single Lane Alternating Bike Traffic

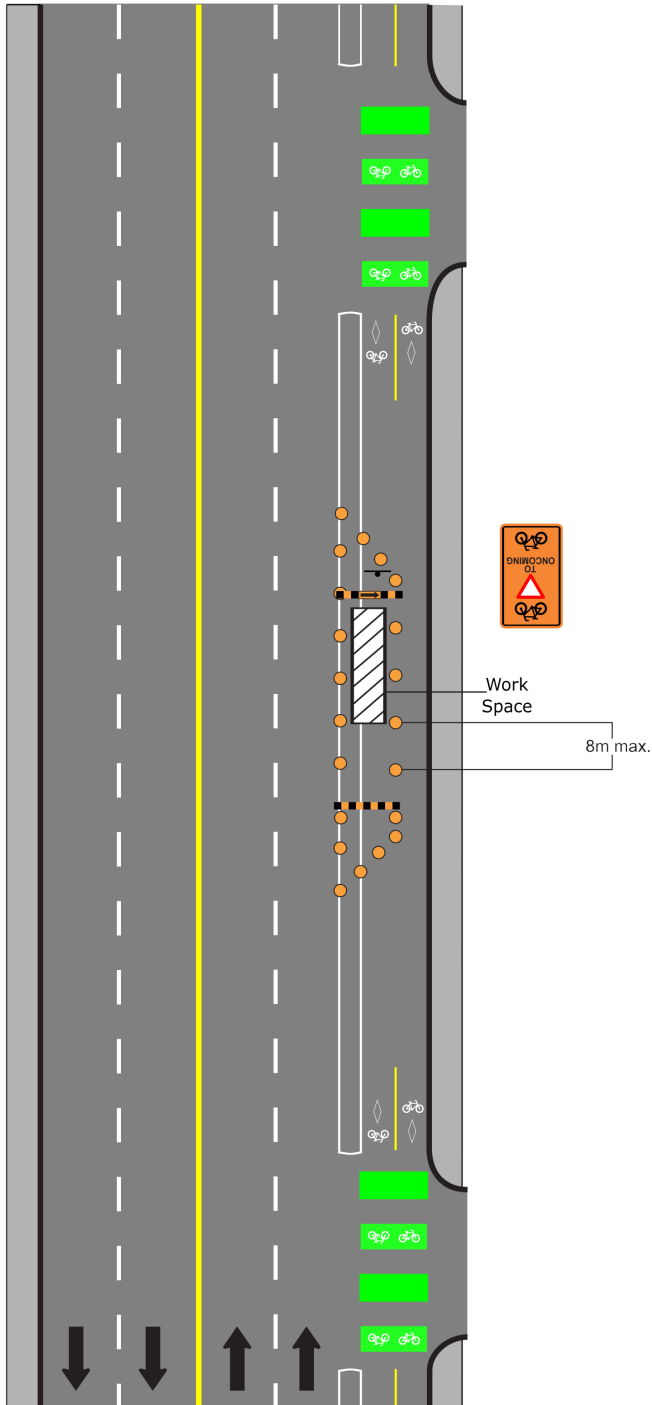

Table 3
Placement of Temporary Traffic Control Devices

V (KM/H)	A (M)	L (M)	B (M)	D (M)
≤50	50	30	35	8
60	50	40	45	12
70	75	60	50	15
80	100	80	60	15
90	100	105	65	18
100	125	125	70	18
110	125	145	75	20

WHERE:

V = Posted Speed Limit

A = Spacing between signs

L = Length of Taper

B = Length of Longitudinal Buffer Space

D = Spacing between Delineation Devices

C7 - Bike Lane Closed:
Temporary Bike Lane

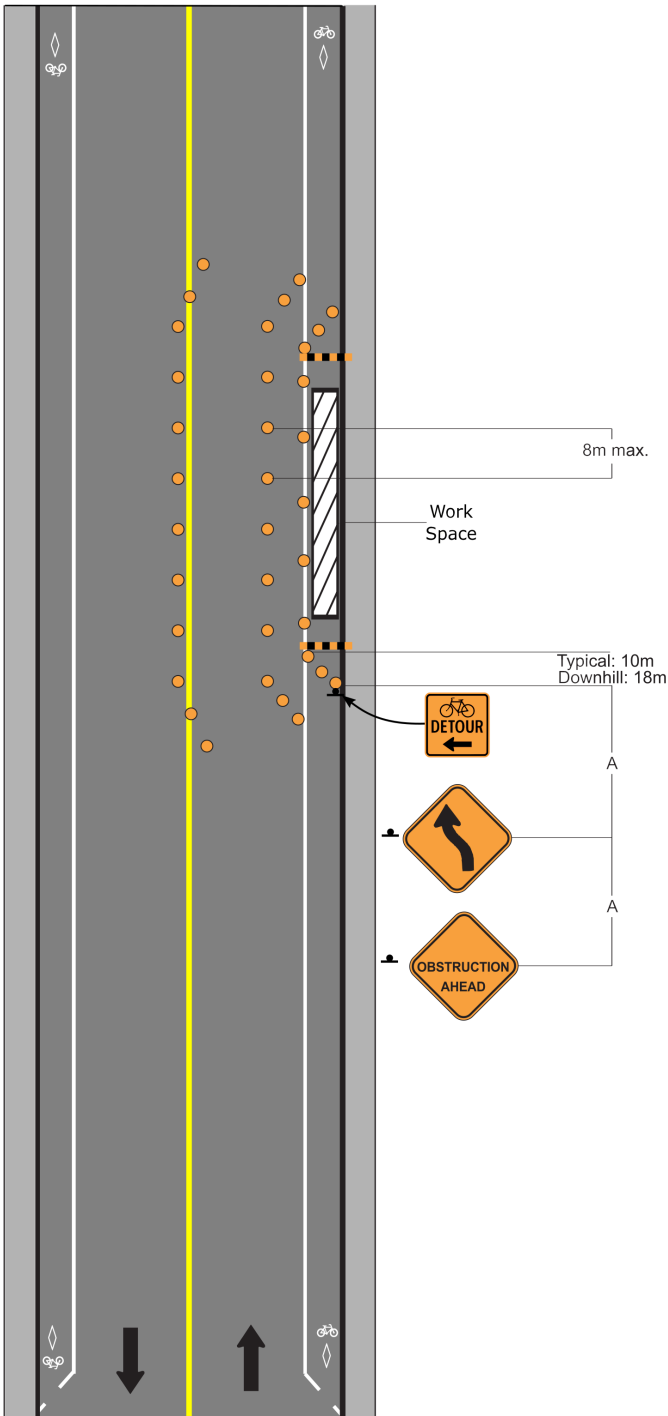

Table 3
Placement of Temporary Traffic Control Devices

V (KM/H)	A (M)	L (M)	B (M)	D (M)
≤50	50	30	35	8
60	50	40	45	12
70	75	60	50	15
80	100	80	60	15
90	100	105	65	18
100	125	125	70	18
110	125	145	75	20

WHERE:

V = Posted Speed Limit

A = Spacing between signs

L = Length of Taper

B = Length of Longitudinal Buffer Space

D = Spacing between Delineation Devices

C8 - Bike Lane Closed:
Cyclist Detour

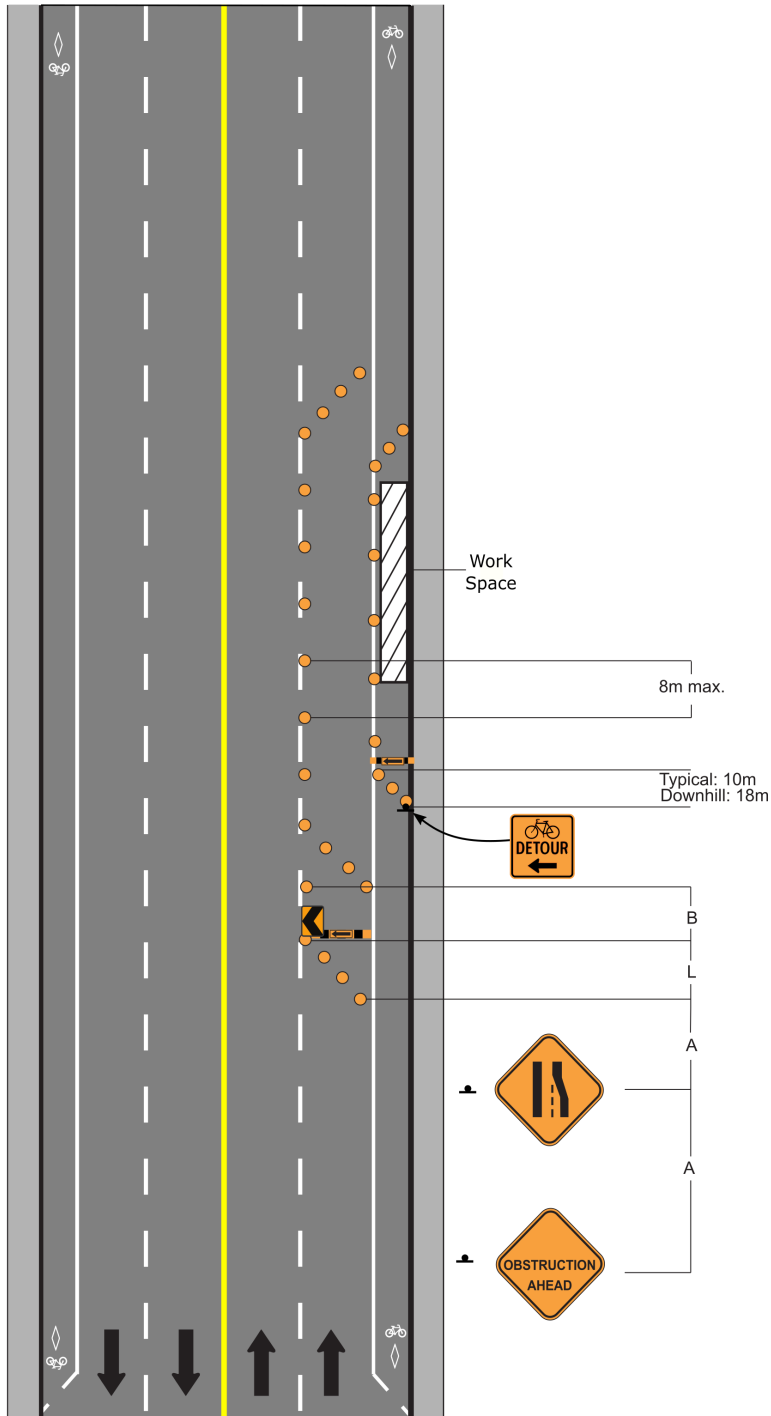

Table 3
Placement of Temporary Traffic Control Devices

V (KM/H)	A (M)	L (M)	B (M)	D (M)
≤50	50	30	35	8
60	50	40	45	12
70	75	60	50	15
80	100	80	60	15
90	100	105	65	18
100	125	125	70	18
110	125	145	75	20

WHERE:

V = Posted Speed Limit

A = Spacing between signs

L = Length of Taper

B = Length of Longitudinal Buffer Space

D = Spacing between Delineation Devices

C9 – Bike Lane Closed:
Cyclist Detour

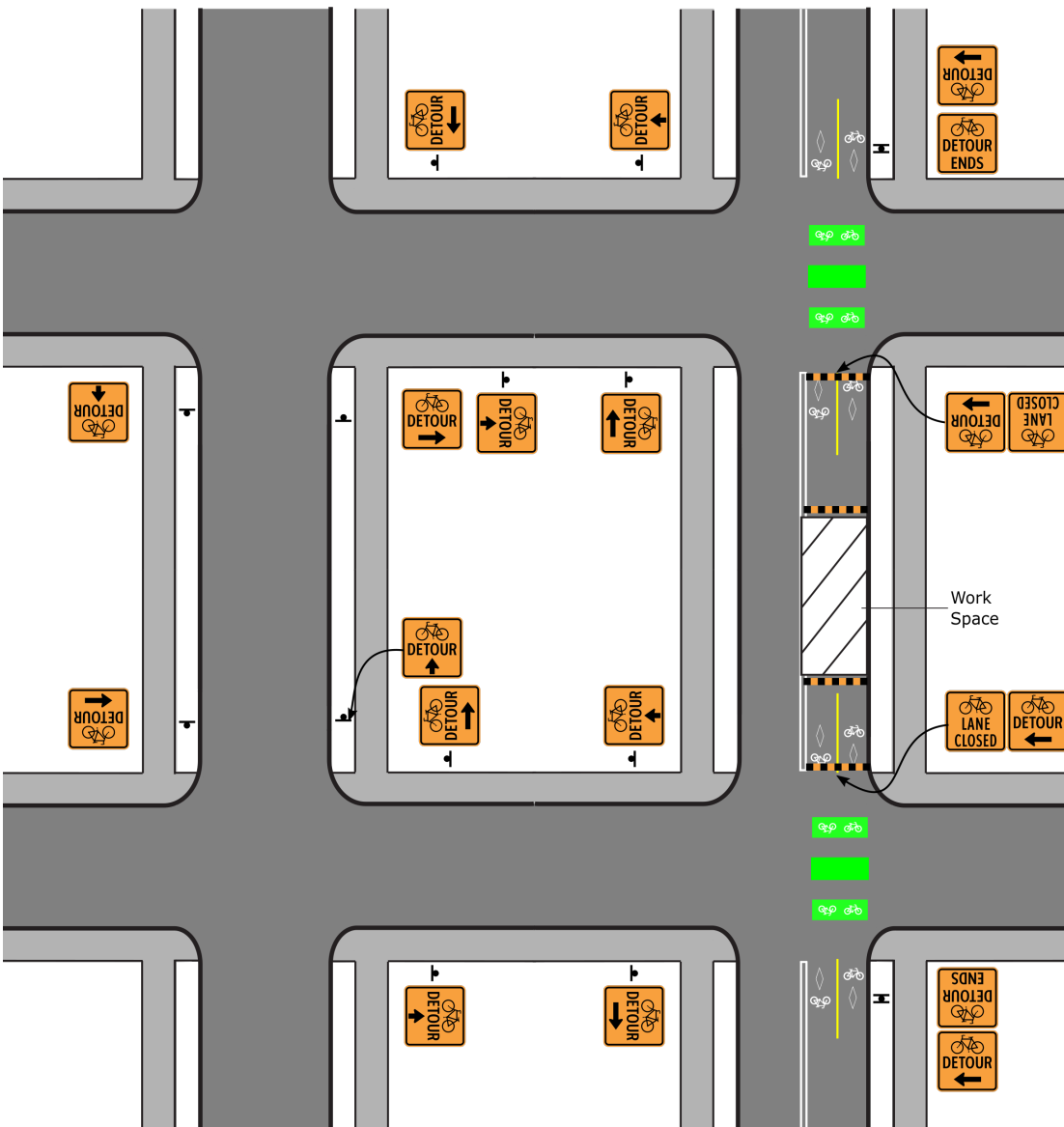

Notes:

1. All bike detours must be reviewed and approved by Parks and Roads Services, prior to implementation.
2. Cyclists shall be detoured to routes that offer a similar level of comfort, safety and travel distance as the existing facility.

C10–Bike Lane Closed:
Cyclists Dismount and Walk

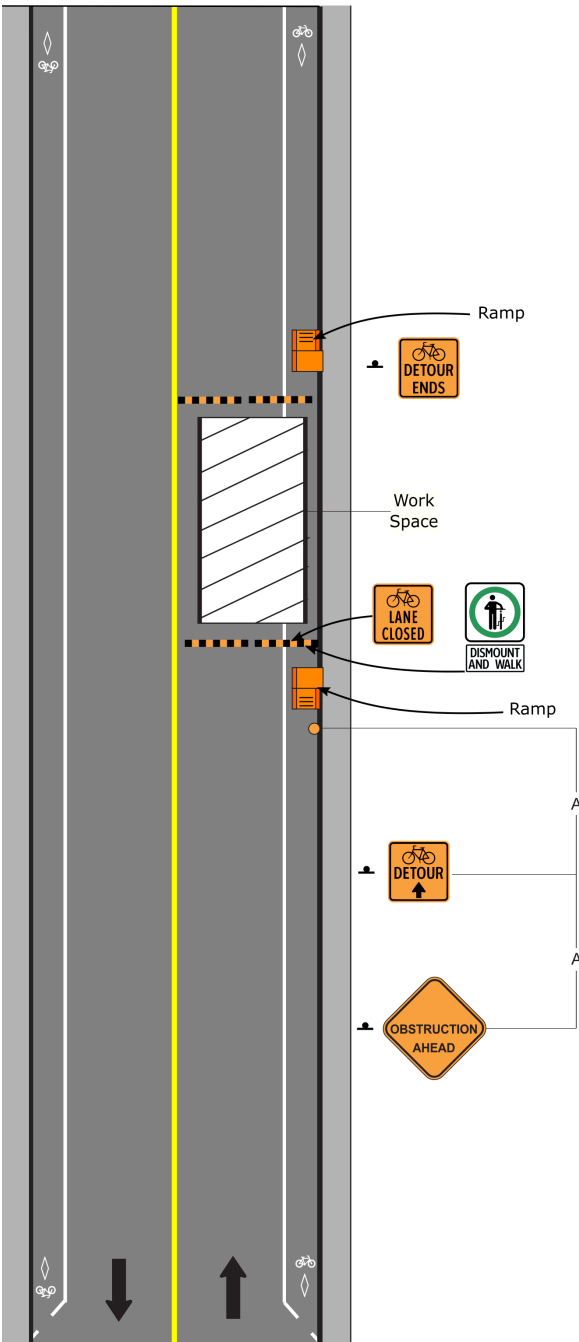

Table 3
Placement of Temporary Traffic Control Devices

V (KM/H)	A (M)	L (M)	B (M)	D (M)
≤50	50	30	35	8
60	50	40	45	12
70	75	60	50	15
80	100	80	60	15
90	100	105	65	18
100	125	125	70	18
110	125	145	75	20

WHERE:

V = Posted Speed Limit

A = Spacing between signs

L = Length of Taper

B = Length of Longitudinal Buffer Space

D = Spacing between Delineation Devices

Notes:

1. Motor vehicle traffic accommodation not shown

C11 – Sidewalk and Bike Lane Closed:
Temporary Sidewalk and Bike Lane

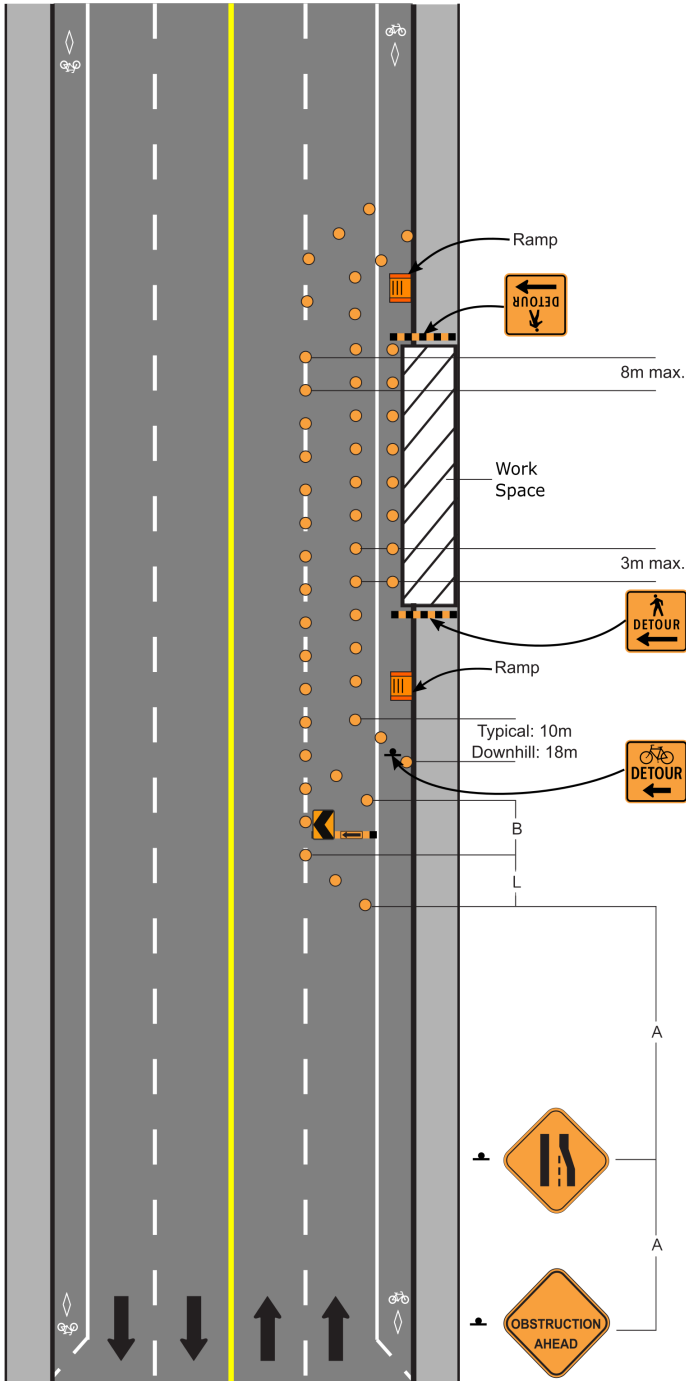

Table 3
Placement of Temporary Traffic Control Devices

V (KM/H)	A (M)	L (M)	B (M)	D (M)
≤50	50	30	35	8
60	50	40	45	12
70	75	60	50	15
80	100	80	60	15
90	100	105	65	18
100	125	125	70	18
110	125	145	75	20

WHERE:

V = Posted Speed Limit

A = Spacing between signs

L = Length of Taper

B = Length of Longitudinal Buffer Space

D = Spacing between Delineation Devices

C12 - Sidewalk and Bike Lane Closed:
Temporary Shared Pathway

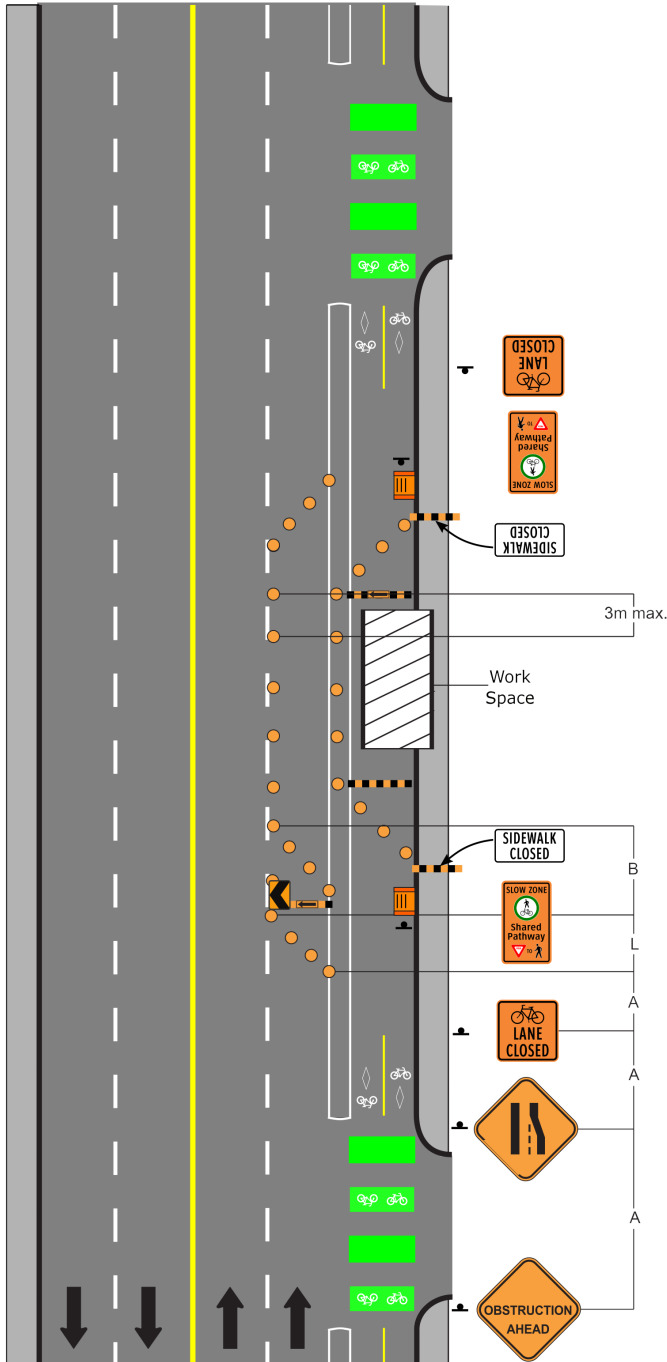

Table 3
Placement of Temporary Traffic Control Devices

V (KM/H)	A (M)	L (M)	B (M)	D (M)
≤50	50	30	35	8
60	50	40	45	12
70	75	60	50	15
80	100	80	60	15
90	100	105	65	18
100	125	125	70	18
110	125	145	75	20

WHERE:

V = Posted Speed Limit

A = Spacing between signs

L = Length of Taper

B = Length of Longitudinal Buffer Space

D = Spacing between Delineation Devices

C13- Sidewalk Closed:
Temporary Shared Pathway in Bike Facility

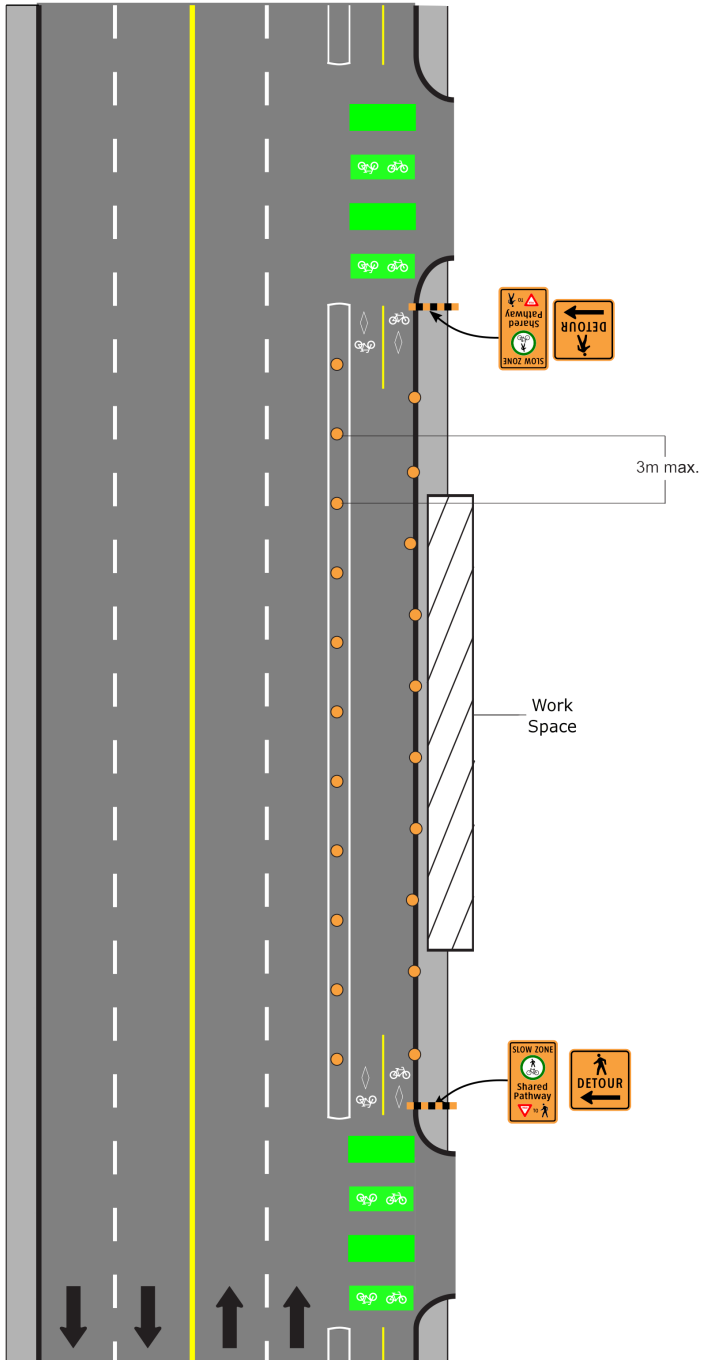

Table 3
Placement of Temporary Traffic Control Devices

V (KM/H)	A (M)	L (M)	B (M)	D (M)
≤50	50	30	35	8
60	50	40	45	12
70	75	60	50	15
80	100	80	60	15
90	100	105	65	18
100	125	125	70	18
110	125	145	75	20

WHERE:

V = Posted Speed Limit

A = Spacing between signs

L = Length of Taper

B = Length of Longitudinal Buffer Space

D = Spacing between Delineation Devices