



# Temporary Traffic Control Manual 2009





# Temporary Traffic Control Manual (2009)

Acknowledgements ..... iv  
 Telephone listings .....v

## Chapter 1 – Introduction

Purpose .....1  
 Scope .....1  
 Authority .....1

## Chapter 2 – Before you work on City ROW (right-of-way)

Worksite assessment and checklist .....3  
     Before the job .....3  
     During the job .....3  
     After the job .....4  
 Required permits/authorization .....4  
 Alberta temporary traffic control accreditation .....4  
 Traffic control person (flagperson) accreditation .....4  
 Field applications accreditation .....4  
 Apparel .....4

## Chapter 3 – Performance guidelines

Pedestrian safety .....11  
 Standards of performance and responsibility .....11  
 Securing the worksite .....13  
     During periods of activity .....13  
     During periods of inactivity .....14  
     Bridging .....14  
 Installation and maintenance .....14  
     Installation .....14  
     Maintenance .....15  
     Record keeping .....15

Temporary work zone component areas .....	16
Basic TTC tapers and tangents criteria .....	16
Duration of work .....	18
Mobile .....	18
Very short duration .....	18
Short duration .....	18
Long duration .....	18
Restricted areas .....	22
Heavy rail ROWs (CN, CP) .....	22
Light rail ROWs (LRT) .....	22
Seventh Avenue transit corridor .....	22
Provincial ROWs .....	23
Stephen Avenue/Barclay malls .....	23

## **Chapter 4 – Guidelines for traffic control devices**

Signs and specifications .....	25
Control of traffic using a traffic control person .....	33
Delineation (channelization) devices .....	34
Barricades .....	36
Acceptable use of barricades .....	36
Non-acceptable use of barricades .....	36
Light barricades .....	37
Heavy barricades .....	37
Traffic barriers .....	39
Arrow boards .....	41
Variable message boards .....	41
Impact attenuators .....	41
Intelligent Transportation Systems (ITS) applications .....	42
Speed fine doubles .....	42

**Chapter 5 – Temporary traffic control (typical applications)**

Drawing index .....43

**Chapter 6 – Incident/emergency procedures**

Guidelines for The City of Calgary personnel .....101

Procedures for trained personnel assigned to emergency incidents .....103

**Glossary** .....105

**Bibliography** .....111

**Appendix**

Record of temporary traffic control .....114

Maximum Speed Ahead sign placement .....115

Street Use Permit application requirements .....116

Hoarding Permit requirements .....117

## Acknowledgements

This manual would not have been possible without the hard work and dedication of the following:

Les A. Brace, Safety Advisor, Roads.

Mario D'Adamo, C.E.T., Operations Co-ordinator, Traffic Field Operations, Roads.

Rick Elvey, Battalion Chief, Calgary Fire Department.

Garnet McLean, C.E.T., Traffic Control Technician, Traffic Engineering, Roads.

Brian Merriman, Design Technician, Subdivision Development, Roads.

John Morrall, P. Eng., Professor Emeritus of Civil Engineering.

Cam Nelson, M.E.Des., Co-ordinator, Traffic Safety, Traffic Engineering, Roads.

Blake Somerset, Truck Unit Sergeant, Calgary Police Service Traffic Section.

Matthew Watts, Spatial Data Co-ordinator, Land Information and Mapping.

Bruce Swanson, P.Eng., Detour Engineer, Traffic Engineering Division.

Alfred Tauscher, Safety Officer, Alberta Transportation.

Tom Yu, Leader Traffic Geomatic Asset Mangement, Land Information and Mapping.

Kelsey Strachan, Creative/Technical Writer, Roads.

Any suggestions, questions or comments regarding the content of this manual should be forwarded in writing to Traffic Engineering, Roads.

## Telephone listings

### 1. Utilities location system

- Alberta One Call – [www.alberta1call.com](http://www.alberta1call.com). **1-800-242-3447**
  - \* Natural gas, phone, power, electric, streetlights, water, sewer and some pipeline locations.
  - \* Some pipeline locations cannot be obtained from Alberta One Call. They must be obtained from the company involved.
- Shaw Cable – Dig Shaw Facility location service.
  - Fax: **(403) 303-6300**
  - Local: **(403) 716-6035**
  - Toll free: **1-866-DigShaw (344-7429)**
- Rail companies control cable locations
  - Canadian Pacific **(403) 319-7000**
  - Canadian National **1-800-665-5662**

### 2. The City of Calgary, Development & Building Approvals

- Permits – Building, Developments, Signs (private), Subdivision, Land Use and Licences. **3-1-1**

### 3. The City of Calgary, Waste & Recycling Services

- Report work affecting garbage pickup. **3-1-1**

### 4. The City of Calgary, Roads Maintenance Division

- Excavation Permit Office, Manchester Building E (Bridging Authorization). **3-1-1**
- Road debris, holes, cave-ins, streetlight trouble, sanding, potholes.

**5. The City of Calgary, Roads, Traffic Engineering Division** **3-1-1**

- Temporary traffic control set-ups and authorization.
- Permanent signage (regulatory, warning, information and guide signs).
- Roadmarking.
- Pedestrian crosswalks.
- Speed limits.
- Permits (hoarding, street use, banner, over-dimensional, parade and special events, block party, special parking permits, commercial loading zone, rickshaw and pedicab, and Stampede bleacher). Available at Manchester Building E.
- Meter hooding.
- Parking management (residential zones, handicap parking, loading zones).
- Special event co-ordination.
- School and playground zones.
- Truck route/DGR issues.
- Railway safety issues.
- Local traffic bylaws and provincial legislation.

**6. The City of Calgary, Roads, Construction and Materials** **3-1-1**

- Indemnification Agreements.

**7. Emergency Use Only**

- Police, fire, ambulance, and emergency. **9-1-1**

**8. Fire Department dispatch and Emergency Medical Services**

- Report work on main thoroughfares which may affect response times. **3-1-1**



## **9. Calgary Downtown Business Association**

- Olympic Plaza/Stephen Avenue/Barclay Mall permits. **(403) 215-1570**

## **10. The City of Calgary, Calgary Transit, Operations Section**

- LRT emergency and permits. **(403) 268-1518**
- Report work affecting bus routes. **(403) 268-1570**  
**(403) 268-1517**
- Transit emergency/Transit radio control (24 hours). **(403) 268-1517**  
**(403) 268-1518**

## **11. Alberta Infrastructure and Transportation**

- Authorization for work on/or affecting provincial ROWs. **(403) 297-6311**



## Chapter 1 – Introduction

### Purpose

The purpose of this manual is to set out standards and specifications for temporary traffic control designed for:

1. The safety of employees at the worksite.
2. The safety of motorists and pedestrians within the traffic control zone.
3. The protection of equipment used at the worksite.
4. Minimizing traffic disruption around the worksite.

### Scope

This manual is intended as a practical working reference to be used by private contractors, consultants, utility companies and City personnel. Uniform standards and procedures are set out in this manual and shall be adhered to when working on or adjacent to roadways under the jurisdiction of The City of Calgary.

All agencies and contractors shall observe and maintain these standards and procedures to ensure:

1. Uniform standards for design and quality of traffic control devices within The City of Calgary ROW.
2. Standardized procedure and placement of traffic control devices to minimize confusion for all users.
3. The promotion of uniform design and standards throughout Canada.

This manual shall be used in conjunction with the *Occupational Health and Safety Act* and *The Traffic Safety Act*, The Alberta Building Code, *Safety Codes Act* and associated regulations, all applicable bylaws and related contract documents.

### Authority

All work performed on City-owned ROW shall conform to the policies, standards and procedures set out by The City of Calgary including this Temporary Traffic Control Manual and the *Alberta Occupational Health and Safety Act*. The Manager of the Traffic Engineering Division, Roads is appointed by Council under Bylaws 20M88 and 26M96, and by the Provincial Government under the *Traffic Safety Act*.

The Traffic Engineering Division manager is the final authority on temporary traffic control standards and sets the extent of traffic disruption allowed on all City-owned ROW. As such, the Traffic Engineering Division (3-1-1) must be notified before commencing work on, or adjacent to, all City-owned ROW.



## Chapter 2 – Before you work on City ROW

### Worksite assessment and checklist

#### Before the job

1. Has Traffic Engineering approved your work order and traffic accommodation plan?
2. Do you need assistance from Roads, Traffic Engineering for temporary traffic control?
3. Do you have the necessary permits (Street Use Permit, Hoarding Permit, Excavation Permit, Indemnification Agreement, etc.)?
4. Is a tree protection plan required? (Contact Parks, Urban Forestry section at 3-1-1.)
5. Do you require a temporary parking accommodation plan?
6. Have you contacted Calgary Transit if you are working on a bus route or LRT right-of-way?
7. Have you given adequate advance notice of the work that you plan to do to the affected businesses, utilities and residents (by means of a letter drop)? Has this letter been approved by Traffic Engineering?
8. Are the proper temporary traffic control devices available at the worksite to accommodate traffic?
9. Are the pedestrians and motorists properly separated and protected from each other and the worksite?
10. Do you have a “Record of Temporary Traffic Control” form?

For further requirements and information, refer to the Appendix.

#### During the job

1. Is there enough proper equipment available to secure the worksite overnight if necessary? Remember, you will need reflective signs, markers, flashers, and sandbags for your set-up. You may also need bridging materials, snow fence and barricades for the worksite. Are there any signs that need to be covered or removed during periods of inactivity (i.e. speed reduction signs)?
2. Are all traffic control devices still in their proper places, aligned and standing upright? Do you need to secure signs with sandbags? Are the signs clean and legible (day and night)?
3. If a traffic control person is being used, are proper procedures being followed? Has the traffic control person(s) been trained by an accredited institution?
4. Does the traffic set-up continue to meet the needs of your job? If not, seek approval from Roads, Traffic Engineering to modify and make changes.
5. Is the work zone being monitored as specified?
6. Do you have an approved contingency plan in place to accommodate peak hour traffic if there is the possibility that the work may run into the peak hour?
7. Have arrangements been made for paving materials to bring the ROW back into service?

### **After the job**

1. Have you obtained approval from Traffic Engineering to re-open the roadway?
2. Have you cleaned up the worksite and rehabilitated the ROW in a condition equal to or better than it was prior to the start of the work?
3. Have arrangements been made to restore or rehabilitate the ROW?
4. Have you removed all temporary traffic control devices?

### **Required permits/authorization**

All work on City-owned ROW requires authorization and, in certain situations, may require a permit(s). For information on required authorization and permits, contact Traffic Engineering by calling 3-1-1.

### **Alberta Temporary Traffic Control accreditation**

It is recommended that all persons designing temporary traffic controls (TTCs) should be accredited by an appropriate agency. Accreditation will assist all parties involved in understanding and implementing temporary traffic control practices and procedures for construction worksites in the province of Alberta. For information regarding the Alberta Temporary Traffic Control Course, please contact the Alberta Construction Safety Association at (1-800-661-6090) or <http://www.acsa-safety.org>.

### **Traffic control person (flagperson) accreditation**

Any individual who will be acting as a traffic control person shall be properly trained in flagging. The Alberta Construction Safety Association offers a course with the objective to standardize traffic control training for the construction industry in Alberta. For additional information regarding this course please contact the Alberta Construction Safety Association at (1-800-661-6090) or <http://www.acsa-safety.org>.

### **Alberta Temporary Traffic Control – field applications accreditation**

It is recommended that all persons involved in the implementation of TTC plans should be accredited by an appropriate agency. Again, the Alberta Construction Safety Association offers a course for those who are actively involved with the field implementation of temporary traffic control plans.

### **Apparel**

With the permission of the Canadian Standards Association, the following material is reproduced from Z96-02, High Visibility Safety Apparel (CSA). While use of this material has been authorized, CSA shall not be responsible for the manner in which the information is presented, nor for any interpretations thereof.

**To contact the CSA, visit [www.csa.ca](http://www.csa.ca).**

## A.1 Basic principles

Users should be familiar with the following principles in the selection of high-visibility apparel:

- a) An assessment of the type and degree of risk should be done for the job site before selecting appropriate high-visibility apparel.
- b) Engineering and administrative controls of traffic and hazards around the workplace should be employed first to reduce risk to pedestrians. High-visibility apparel is considered to be a second line of defence against accidents.
- c) Worksite background significantly affects the conspicuity of garments.
- d) Higher contrast between the background and the workers' apparel provides greater conspicuity.
- e) Environmental conditions (e.g. lightning, rain, fog and snow) significantly affect a garment's conspicuity.
- f) Bright colours are more conspicuous than dull colours under daylight conditions.
- g) Bright colours are less effective than fluorescent colours under low-light conditions.
- h) Large, bright garments are somewhat more conspicuous than small ones.
- i) Full-body coverage provides better conspicuity than partial-body coverage.
- j) Coverage of 360° around the body provides better conspicuity in all viewing directions.
- k) Stripes of colours that contrast with the background material provide even greater conspicuity.
- l) Contrasting stripes provide visual clues to the motion and nature of the object they cover.
- m) Stripes on the arms and legs provide a greater indication of motion and greater conspicuity.
- n) Retroreflective materials provide high conspicuity under dark conditions (they are preferred over bright colours).
- o) Greater retroreflectivity provides greater conspicuity under low light conditions.
- p) Contaminated or dirty retroreflective materials provide lower conspicuity.
- q) For optimal performance, garments should be maintained in accordance with the manufacturer's instructions.
- r) For optimal performance, garments should be kept clean (i.e. washed regularly if advised on the garment label).
- s) For safety and best performance, garments should be fitted to the person, taking into consideration the bulk of clothing to be worn underneath the garments.
- t) For safety and best performance, garments should be worn as intended: done up properly around the body with no loose or dangling components.

- u) Garments should be selected and worn in a manner that ensures no other clothing or equipment obscures the high-visibility materials (e.g. glove gauntlets, equipment belts and high-cut boots).
- v) Garments no longer able to provide minimum acceptable levels of conspicuity due to wear and tear, soiling, contamination, or age, present a false sense of safety and should be replaced.
- w) Other factors such as flame resistance, thermal performance, durability, launderability, comfort, flexibility and sizing should be considered when selecting a garment for the job.

## Annex B (Informative)

Note: This Annex is not a mandatory part of this Standard.

### Examples of Garment Designs

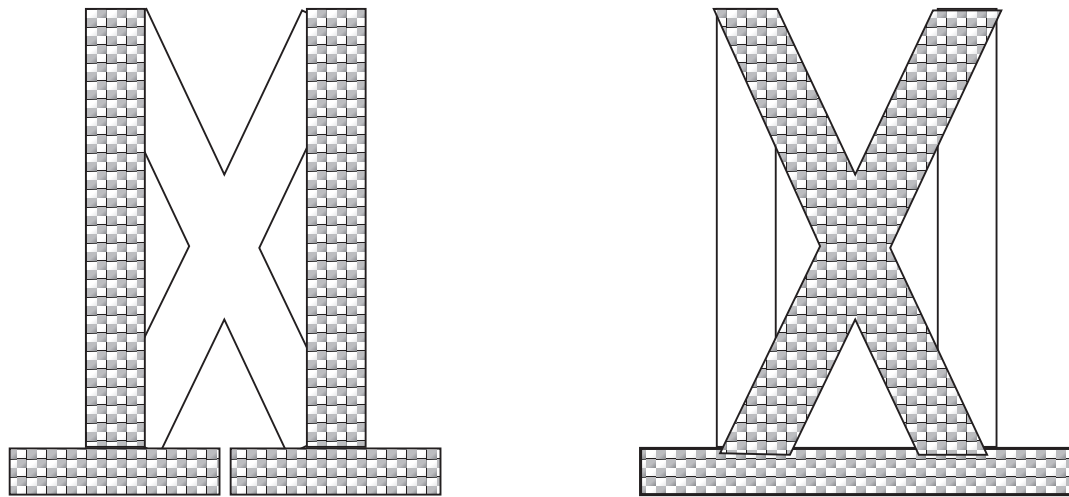

Figure B.1

### Class 1 - Harness or Colour/Retroreflective Stripes on Other Clothing

With the permission of Canadian Standards Association, material is reproduced from CSA Standard, Z96-02, titled High-Visibility Safety Apparel, which is copyrighted by Canadian Standards Association, 178 Rexdale Blvd., Toronto, Ontario, M9W 1R3. While use of this material has been authorized, CSA shall not be responsible for the manner in which the information is presented, nor for any interpretations thereof. To contact CSA visit [www.csa.ca](http://www.csa.ca)

### Examples of garment designs

---

454.1016.032



## Annex B (Informative)

Note: This Annex is not a mandatory part of this Standard.

### Examples of Garment Designs

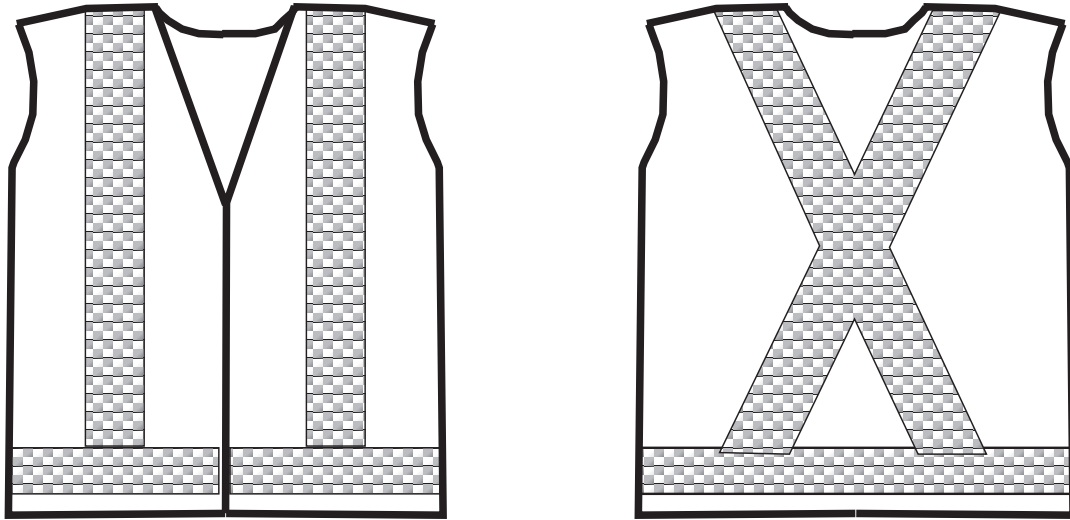
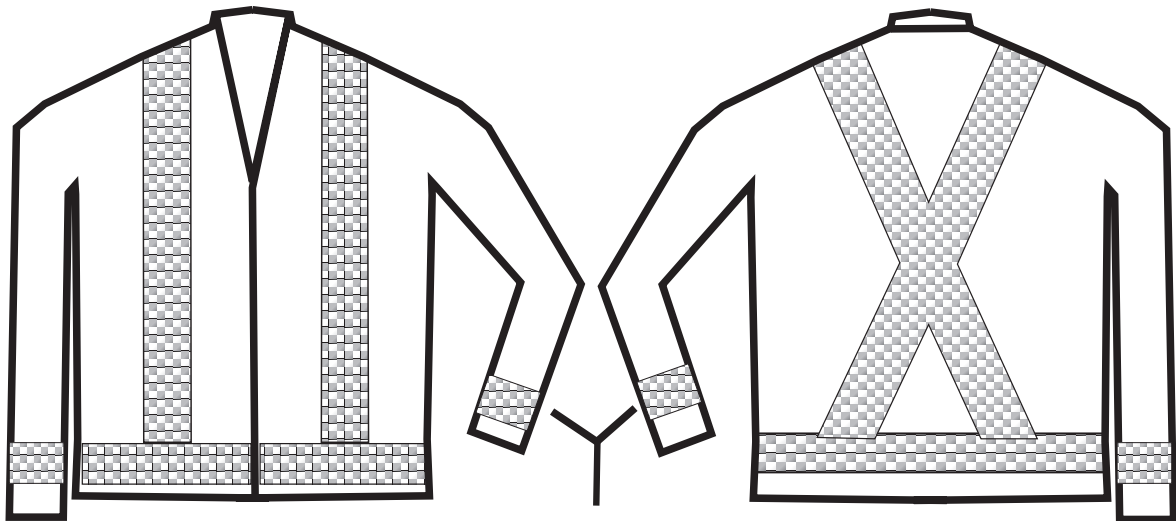

Figure B.2

Class 2 - Vest



(Optional arm bands)

Figure B.3

Class 2 - Jacket

With the permission of Canadian Standards Association, material is reproduced from CSA Standard, Z96-02, titled High-Visibility Safety Apparel, which is copyrighted by Canadian Standards Association, 178 Rexdale Blvd., Toronto, Ontario, M9W 1R3. While use of this material has been authorized, CSA shall not be responsible for the manner in which the information is presented, nor for any interpretations thereof. To contact CSA visit [www.csa.ca](http://www.csa.ca)

## Annex B (Informative)

Note: This Annex is not a mandatory part of this Standard.

### Examples of Garment Designs

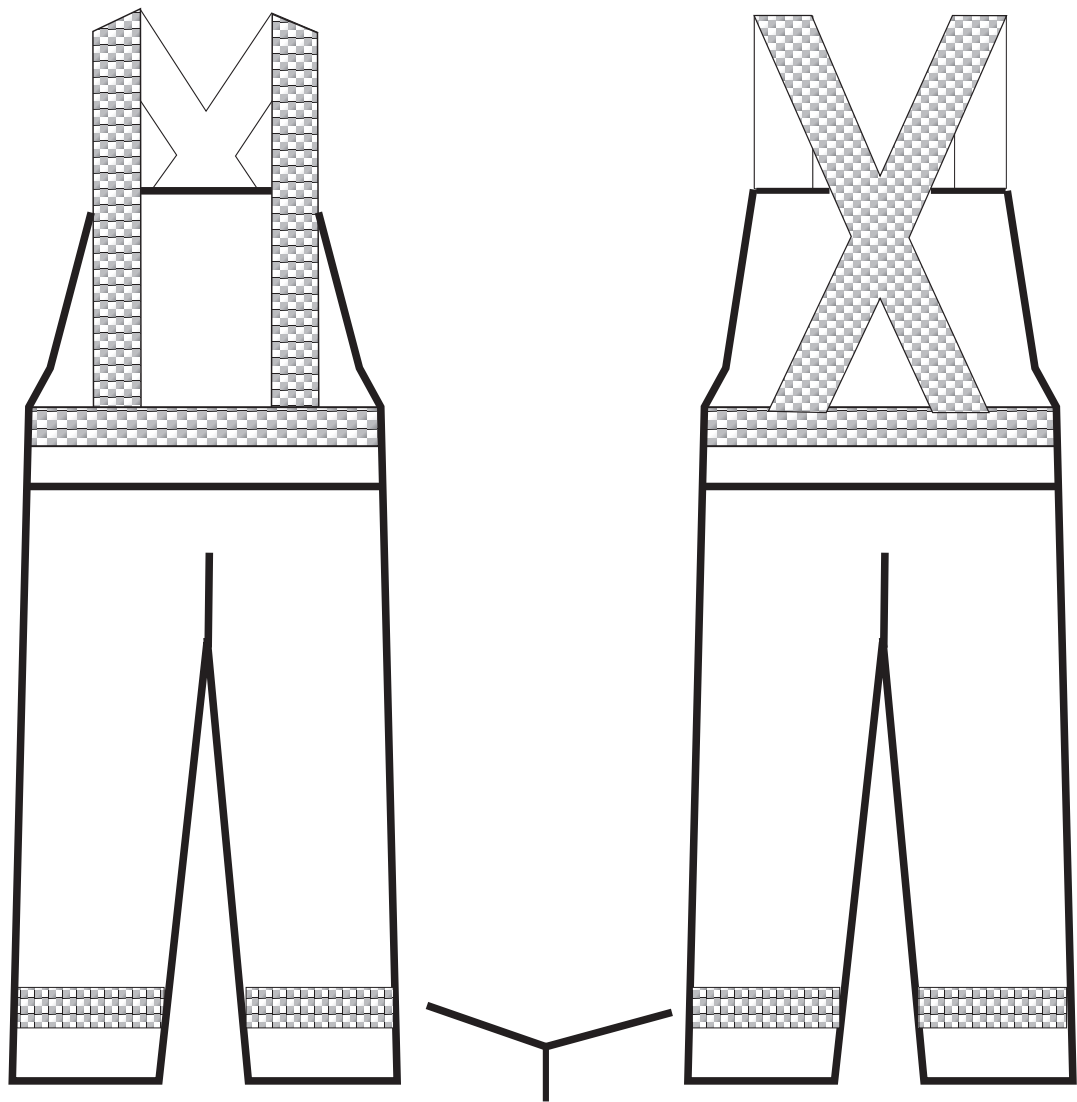

(Optional leg bands)

Figure B.4

### Class 2 - Bib Overalls

With the permission of Canadian Standards Association, material is reproduced from CSA Standard, Z96-02, titled High-Visibility Safety Apparel, which is copyrighted by Canadian Standards Association, 178 Rexdale Blvd., Toronto, Ontario, M9W 1R3. While use of this material has been authorized, CSA shall not be responsible for the manner in which the information is presented, nor for any interpretations thereof. To contact CSA visit [www.csa.ca](http://www.csa.ca)

### Examples of garment designs

454.1016.034

## Annex B (Informative)

Note: This Annex is not a mandatory part of this Standard.

### Examples of Garment Designs

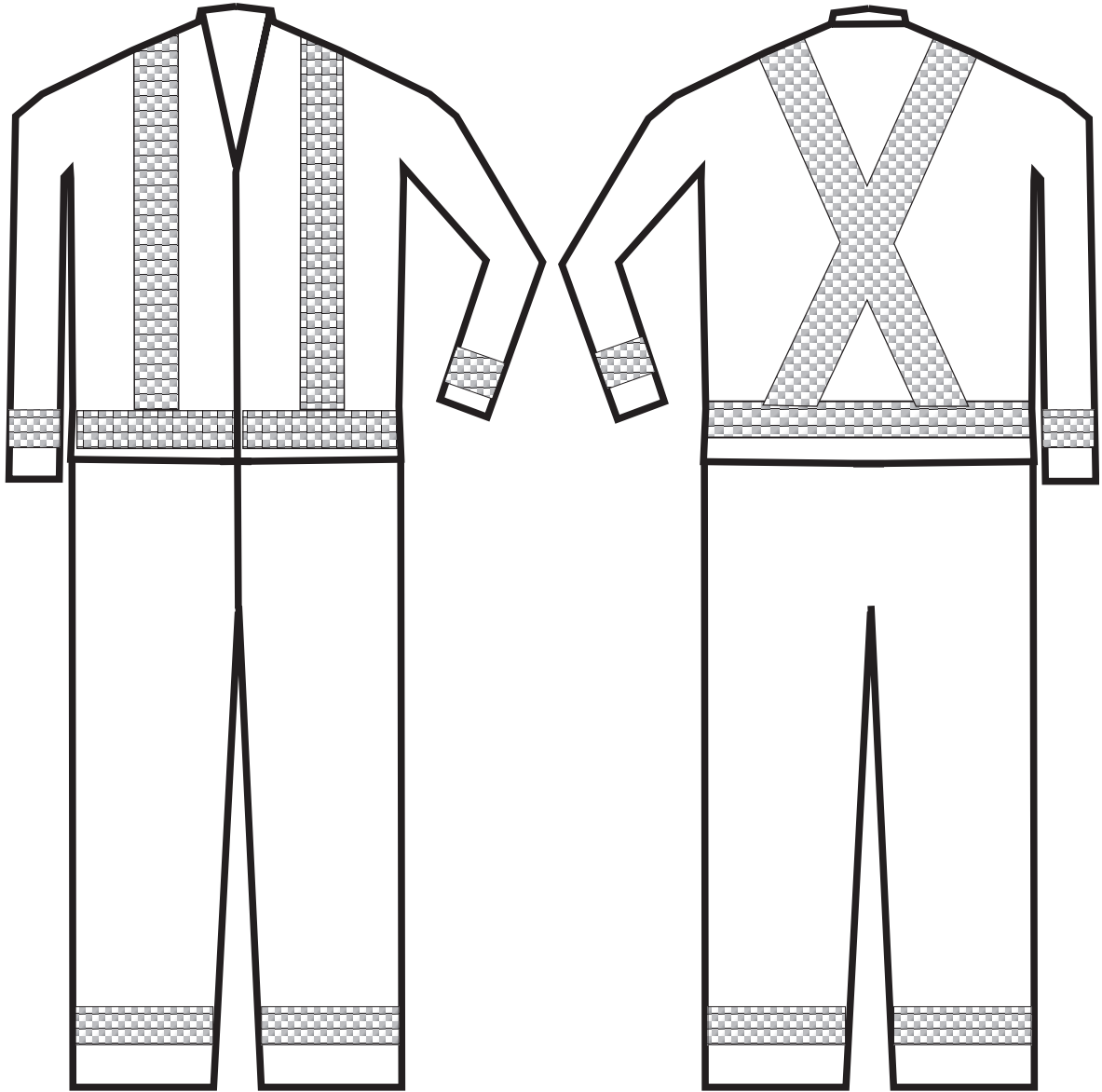

Figure B.5  
Class 3 - Coverall

With the permission of Canadian Standards Association, material is reproduced from CSA Standard, Z96-02, titled High-Visibility Safety Apparel, which is copyrighted by Canadian Standards Association, 178 Rexdale Blvd., Toronto, Ontario, M9W 1R3. While use of this material has been authorized, CSA shall not be responsible for the manner in which the information is presented, nor for any interpretations thereof. To contact CSA visit [www.csa.ca](http://www.csa.ca)



## Chapter 3 – Performance guidelines

### Pedestrian safety

Although the contents of this manual deal mostly with the motoring public, it must be recognized that providing for the safety of pedestrians is equally important. The following standards shall be maintained to ensure pedestrian safety:

1. Pedestrian and vehicular traffic must be physically separated.
2. Pedestrian traffic must be physically separated from workers and equipment in the work area. Accommodations must be made for a safe passage through or around the work area.

For example, crosswalks and sidewalks may be closed to prevent pedestrian traffic through or around the work area, provided alternate means of detouring pedestrian traffic is available.

In cases where it is not possible to detour pedestrian traffic, pedestrians will have to be protected as they pass through the work area. This may require the use of barricades to separate the worksite from the pedestrian walkway. It may be necessary to use bridges (complete with handrails) and sheltered walkways. In all cases, measures taken to protect the pedestrians must be to the satisfaction of the Manager, Traffic Engineering.

Specifications used for bridges and hoarding must be reviewed by Traffic Engineering prior to commencing any work.

### Standards of performance and responsibility

With the exception of emergency related work, all work on City-owned ROW shall:

1. Be approved by Traffic Engineering under authority of the manager. They will set the extent of traffic disruption allowed. They will determine temporary traffic control necessary for the work proposed.
2. Be pre-authorized and reported to the Traffic Engineering four working days in advance of expected start date. Traffic Engineering (3-1-1) is located in Manchester Building E.
3. Require authorization and/or a special permit when working in restricted areas.
4. Require an Excavation Permit from Road Maintenance division (Manchester Building E) before the excavation is started.
5. Require a Building or Demolition Permit from Development & Building Approvals (Municipal Building) before building or demolition is started.

In the case of emergency related work, contact Traffic Engineering before work is started. Phone 101 Dispatch at 3-1-1. Notify Tri-Services at 3-1-1 (9-1-1 for life threatening situations) of the location of any detour or diversion on any arterials, expressways or freeways. Always use qualified traffic control persons or City police to supplement an incomplete set-up under these circumstances.

*In all cases:*

1. All necessary traffic control devices must be in place before work commences. These devices shall be maintained by the contracting agency for the duration of work/temporary traffic control while any obstruction to traffic exists. These devices shall remain in place for the duration of work.
2. Minimum lane width shall be 3.0 metres per lane. This width shall be adjusted upward under circumstances such as curves, heavy vehicle traffic, truck routes, bus routes or high-speed situations.
3. All temporary traffic control set-ups shall be to the satisfaction of Traffic Engineering. The set-up shall be maintained satisfactory at all times until normal conditions are restored.
4. Street closures and/or detours may be preferable rather than using complicated traffic set-ups or traffic control persons. Approval shall be obtained from the Traffic Engineering four working days in advance of expected start date.
5. It is the responsibility of the contractor, utility company or business unit to notify affected residents/businesses of road closures, parking restrictions and other work that impacts normal traffic flow. The recommended method to notify the public of parking restrictions is by advanced signage.
6. Requests for parking meters to be hooded and “No Parking” zones to be established require four working days advance notice. The requesting party or Traffic Engineering (under contract) shall place “No Parking” signs 12 to 24 hours prior to commencing work. In either case, the requesting party is responsible for sign maintenance. Parking control personnel will check the “No Parking” zone 12 hours in advance of the prescheduled work to ensure sufficient signing. This zone will only be enforced provided there is sufficient signing and adequate advanced notice.
7. Calgary Transit must be notified of work affecting a bus route or bus stops. For a simple traffic diversion, Calgary Transit requires one full working day advanced notice. For a traffic detour, notify Calgary Transit at least two full working days in advance. Traffic Engineering can assist in work affecting transit routes/stops. Avoid delaying transit operations whenever possible. If a problem arises, a transit operator can radio for a supervisor to meet at the work site.

*In case of emergency work affecting Calgary Transit:*

Contact the co-ordinator of Operations during office hours (7:30 – 16:00 Monday to Friday) at 268-1570. After office hours, or on weekends and holidays contact the Transit Radio Control Office at 268-1422, 268-1517 or 268-1518.

8. Waste & Recycling Services (3-1-1) shall be notified 24 hours in advance of laneway or street closures affecting garbage pickup for longer than one day. Notify Waste & Recycling Services immediately of emergency work affecting garbage pickup.
9. Rush hour traffic in The City of Calgary is typically from 6:30 a.m. to 9 a.m. and from 3:30 p.m. to 6 p.m., Monday to Friday. During these times, construction work is not allowed on arterials, expressways or freeways except in cases of emergency or with prior approval of the Traffic Engineering.
10. When traffic lanes within the worksite are required to be open to travel (i.e. during rush hours or at the end of a shift), trenches and small excavation sites may be bridged with steel plates. This should be used only if backfilling all or part of a trench is not practical. Bridging must meet City of Calgary standards and specifications.

11. Contracting departments or agencies shall ensure that private contractors, and other agencies working for them, maintain City of Calgary procedures and standards. Traffic Engineering may inspect any worksite at any time and recommendations made by Traffic Engineering shall be implemented.
12. The restoration of road surfaces, sidewalks and boulevards must be to the satisfaction of the Roads business unit.
13. Occasionally, an emergency vehicle (e.g. police cruiser, ambulance, fire truck) will approach the traffic control zone with sirens and lights flashing. Worksite employees are responsible to see that traffic is stopped by accepted traffic control methods so the emergency vehicle may safely drive through the traffic control zone.
14. Traffic Engineering shall be notified if a permanent traffic sign has to be removed. This should be reported at the same time as approval for traffic set-up is sought. Traffic Engineering shall place a portable sign to replace the permanent sign. The permanent sign must be removed and replaced by Traffic Engineering.
15. Any disruption that may affect signal timing or signal operations shall be co-ordinated with Traffic Engineering. In the event of a signal related emergency contact the Traffic Management Centre at 3-1-1.

## **Securing the worksite**

Securing the worksite is necessary to protect the public from potential hazardous conditions within the work zone. It is necessary to secure the worksite during any periods of inactivity and during the period when work is taking place. Some examples of inactivity are shutdowns due to weather conditions, end of shift, weekends, holidays and lunch/coffee breaks. The necessary steps to secure the worksite are outlined below:

### **During periods of activity**

1. Ensure that all temporary traffic control devices are legible and properly positioned.
2. All devices must be retro-reflective.
3. Remove or securely cover any signs that are not required or are conflicting. For example, cover the gazetted speed if the set-up requires a speed reduction.
4. Place barricades around all stockpiled material, spoil piles and equipment that is stored on the road or the shoulder.
5. All temporary traffic control devices shall be properly secured.
6. Inspect the worksite as required and keep record of inspection.
7. Once secured, drive the worksite to ensure that the set-up provides the motorists with adequate advanced warning and provides positive guidance through the worksite. This should be done during the day, and night for overnight set-ups. Adverse conditions may require adjustment of the traffic control devices and any changes made shall be recorded. Ensure that safe pedestrian movement is maintained and pedestrian and vehicle movements are separated.

## **During periods of inactivity**

1. Where possible, remove all equipment and materials from the roadway.
2. Establish a barrier around open excavations using physical barriers, such as concrete safety shaped barriers, suitable fencing, etc. The location and the nature of the excavation will dictate the method used to provide the necessary safety required.
3. Place barricades around all stockpiled material, spoil piles and equipment that is stored on the road or the shoulder.
4. Retro-reflective chevrons or flashers shall be used to delineate the tapers. Flashers shall be used to separate the travel lane(s) and the worksite. They shall also be used to identify material and equipment storage on the road or the shoulder. Roads, Traffic Field Operations does not supply flashers with their temporary traffic control set-ups. It is therefore the responsibility of the contractor, utility company, or other City department to supply and maintain these.
5. All traffic control devices shall be secured during periods of inactivity.
6. Arrange to have roads within the traffic control zone sanded during periods of icy conditions.
7. Remove or cover any signage that is not required.
8. Inspect the worksite as required and keep a record of the inspections.

Once secured, drive the worksite to ensure that the set-up provides the motorists with adequate advanced warning and provides positive guidance through the worksite. This should be done during the day, and at night for overnight set-ups. Adverse conditions may require adjustment of the traffic control devices and any changes made shall be recorded. Ensure that safe pedestrian movement is maintained and pedestrian and vehicle movements are separated.

## **Bridging**

When steel plate bridging is required on city streets, the following standards shall be maintained:

- Contact Traffic Engineering to determine the necessary set-up required (for example, plating may require a speed reduction).
- Bump signs shall be provided for each traffic direction.
- All bridge edges must be smoothed out or feathered using hot or cold mix asphalt.
- All bridge plates must be adequately pinned to the road surface to prevent bridge movement.
- Temporary hazard markers shall be used to mark the location of bridging plates.
- Insulate the plates to prevent banging; especially in the vicinity of residential communities.
- Define/highlight the edges of the plating with high visibility material, such as fluorescent orange paint.

## **Installation and maintenance**

### **Installation**

All devices shall be placed in a manner so as not to interfere with existing traffic control devices. It is important to survey the site before preparing a temporary traffic control plan. This ensures any conflicting



signs are covered or removed. For example, if a speed reduction is required, the gazetted signs shall be covered or removed. Adjust traffic signals. Work in the proximity of a signalized intersection may require signal timing revision based on the circumstances. Revise roadmarking where required and remove redundant roadmarking or addition of new marking.

### Maintenance

It is important to maintain all temporary traffic control devices. Some examples of maintenance include, but are not limited to:

- Cleaning all signs and devices.
- Ensuring all signs and devices are located as per plan.
- Ensuring all signs and devices are secured for adverse conditions.
- Cleanliness and operation of flashing lights for night use.

### Record keeping

Record keeping is an important component of temporary traffic control to document and ensure the appropriate measures are in place at all times. The project supervisor is responsible for maintaining a record of the temporary traffic control used, and taking the necessary steps to correct any deficiencies. This may include contacting Traffic Engineering, other providers of traffic control or, in the case where the contractor has been given the authority to provide its own traffic control, correcting the deficiency. A “Record of Temporary Traffic Control” is provided as a sample form for the purpose of record keeping.

**RECORD OF TEMPORARY TRAFFIC CONTROL\***

PROJECT		ADDRESS	
WORK ORDER		CONTACT NAME	
PHONE #	CELL		FAX
COMPANY		DATE	
COMPLETED		PAGE	OF
		Inspected by	

Date yyyy/mm/dd	Time 24 hr	Traffic Control Plan	Type of setup	As per plan	Type of deficiency and location	Photo taken	Action taken

Typical Types of Set-ups and Common Abbreviations:

- |  |  |
|--|--|
| <ul style="list-style-type: none"> <li>RLCA: Right Lane Closed Ahead</li> <li>LLCA: Left Lane Closed Ahead</li> <li>2RLCA: Right Lanes Closed Ahead</li> <li>2LLCA: Left Lanes Closed Ahead</li> <li>TWT or 2WT: Two Way Traffic</li> <li>SWC: Sidewalk Closed</li> <li>HRDING: Hoarding Permit</li> </ul> | <ul style="list-style-type: none"> <li>NPAT: No Parking Anytime</li> <li>NTT: No Through Traffic</li> <li>LTO: Local Traffic Only</li> <li>RC: Road Closed</li> <li>RLCA BD: Right Lane Closed Ahead Both Directions</li> <li>LLCA BD: Left Lane Closed Ahead Both Directions</li> </ul> |
|--|--|

\* Refer to Appendix for 8 1/2" x 11" copy

## Temporary workzone component areas

A typical temporary traffic control set-up can be divided into four areas:

1. Advanced warning area: this area is used to inform the road users of the upcoming workzone and what action to take.
2. Transition area: this area is used to move the road users out of the normal path.
3. Activity area: this is the area where the work takes place and contains the buffer space and the traffic space.
4. Termination area: this area is used to allow the road users to return to their normal path.

Please refer to the diagram “Components of a Temporary Traffic Control Zone” which details the above areas.

## Basic TTC Tapers and Tangents criteria

### Type of taper

Merging taper – 2 lanes to 1 (lane closure)

Shifting taper

Shoulder taper

One Lane – two-way traffic taper

Downstream taper

### Taper Length (L)(metres)

L Minimum

L/2 Minimum

L/3 Minimum

30m Maximum

30m Minimum

### Tangents between tapers

Merge followed by merge

Merge followed by shift

### Tangent Length (L)(metres)

2L (desirable) L (minimum)

L/2

Please refer to the following diagrams which detail the various tapers and their uses.

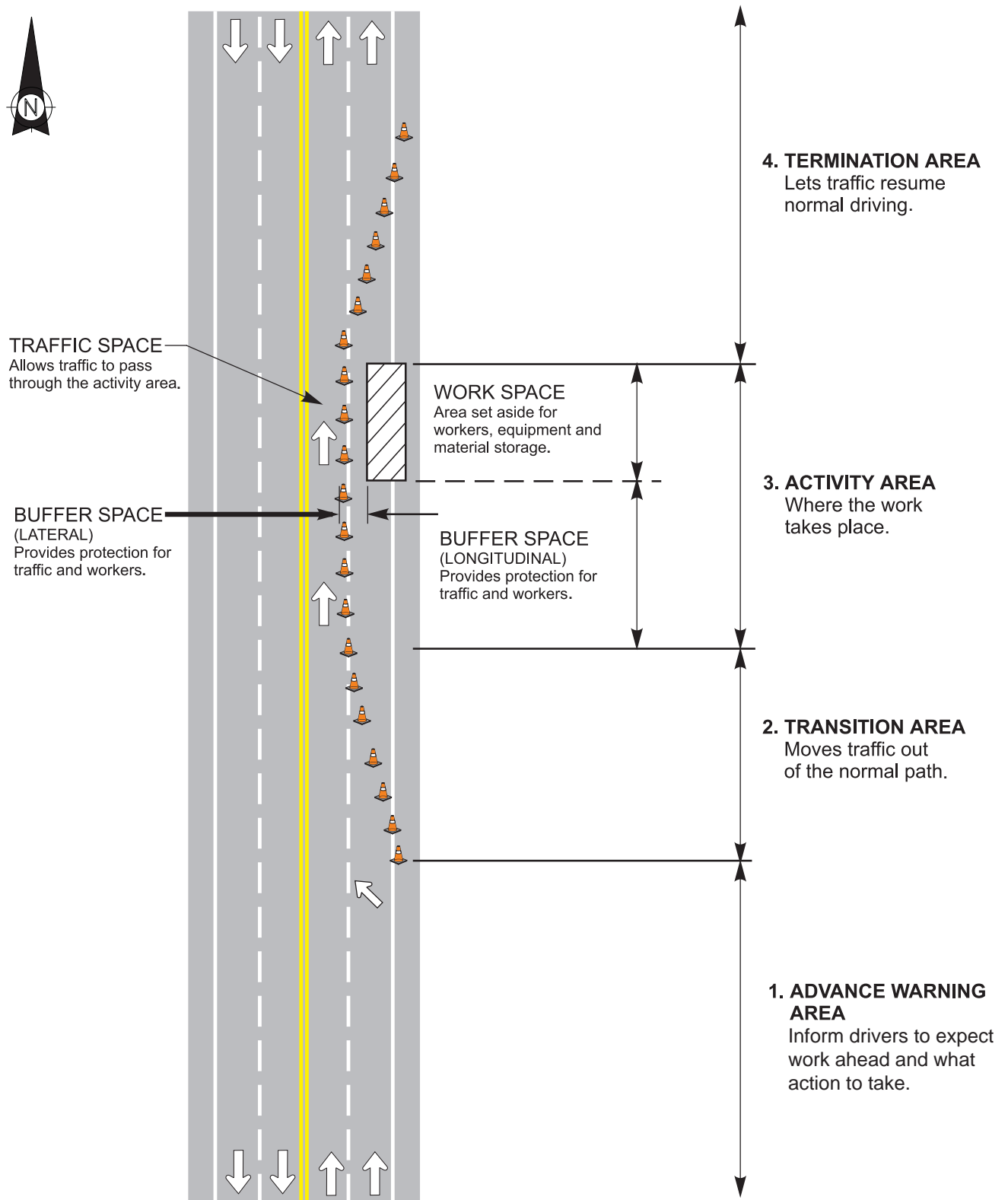

**Components of a temporary traffic control zone**

454.1016.001

## **Duration of work**

### *Mobile*

- Mobile operations are those that are typically performed on the move at low speed and may require periodic stopping for only a few minutes.
- Examples of mobile operations are: street sweeping, longitudinal pavement marking, watering of trees and hydro-seeding.

### *Very short duration*

- Very short duration operations are those that can be completed in 30 minutes or less and may be stationary or mobile with frequent short stops.
- Examples of very short duration operations are: minor utility and roadwork, crack sealing, bus shelter washing, catchbasin cleanout, pothole patching/repair, symbol and transverse roadmarking, minor sign maintenance, signal light replacement and emergency response (e.g. spills and vehicular accidents).

### *Short duration*

- Short duration operations are stationary and range between 30 minutes and 24 hours.
- Examples of short duration operations are: maintenance, sidewalk/boulevard repair, utility work, asphalt patching, emergency water-main repairs and emergency response (e.g. spills and vehicular accidents).

### *Long duration*

- Long duration operations are stationary and take longer than 24 hours.
- Examples of long duration operations are: manhole replacement, utility replacement, bridge rehabilitation, roadway upgrading (e.g. interchange construction), large paving operations and sidewalk/boulevard replacement.

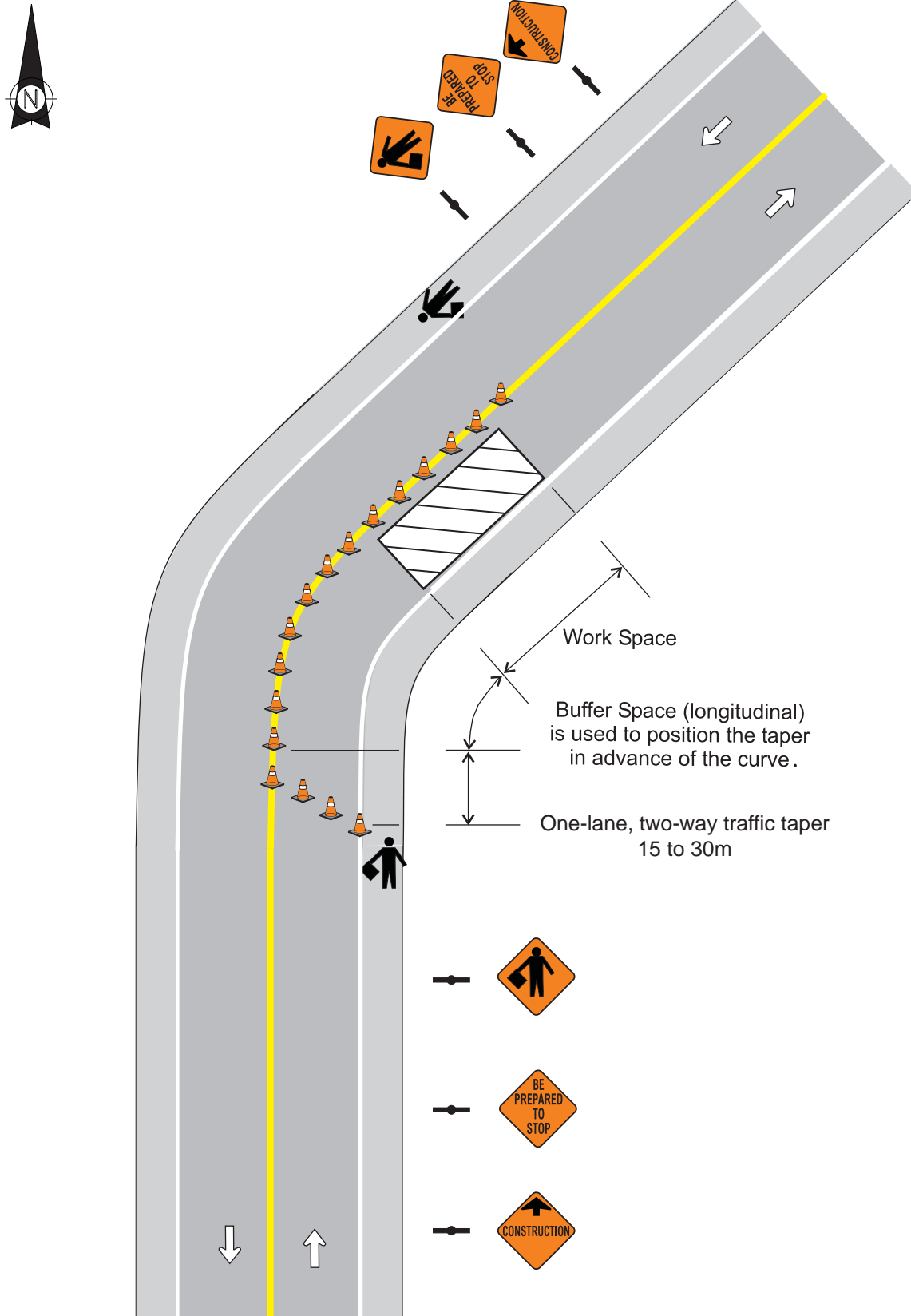

**One-lane, two-way traffic taper**

454.1016.002

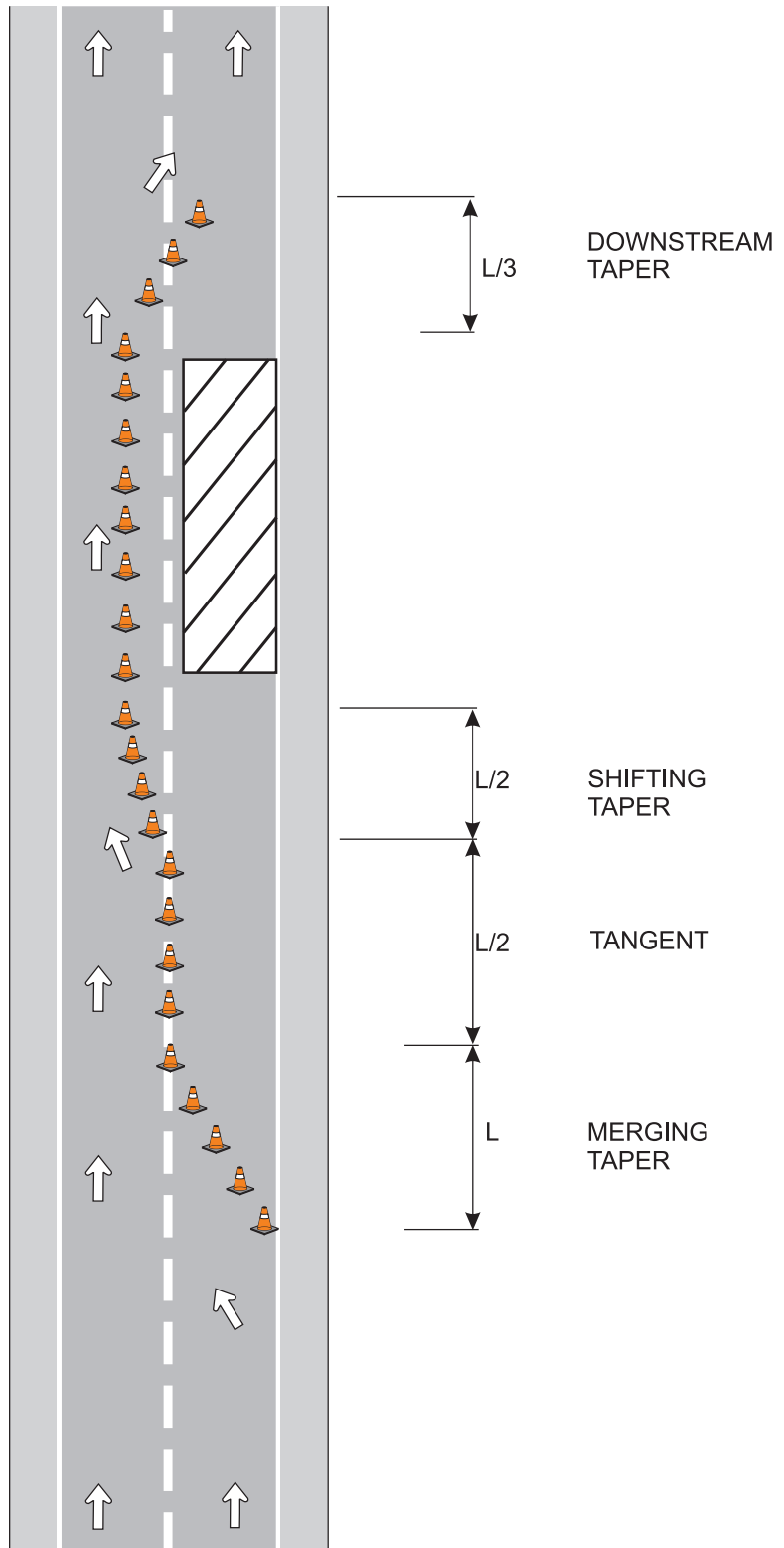

**Note:**  
This drawing is a graphical representation of the detour setup. It is **not** drawn to scale.

V(km/h)	A(m)	L(m)	B(m)	D(m)		
50	50	30	35	8		
60	50	40	45	12		
70	75	60	50	15		
80	100	80	60	15		
90	100	105	65	18		
100	125	125	70	18		
110	125	145	75	20		

Where:  
**V** = Posted Speed Limit  
**A** = Spacing between signs  
**L** = Length of Taper  
**B** = Length of Longitudinal Buffer Space  
**D** = Spacing between Delineation Devices

### Merge taper followed by a shift taper

454.1016.003

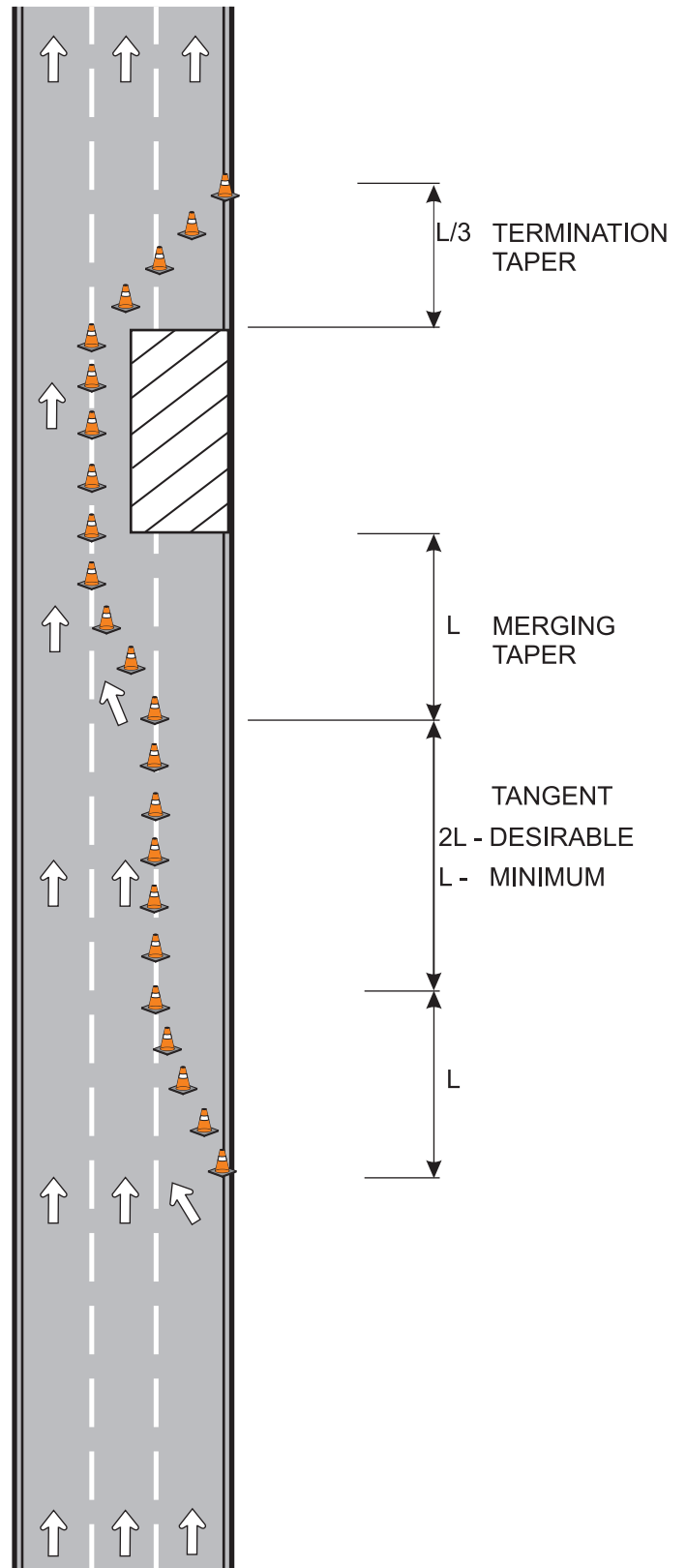

**Note:**  
This drawing is a graphical representation of the detour setup. It is **not** drawn to scale.

V(km/h)	A(m)	L(m)	B(m)	D(m)		
50	50	30	35	8		
60	50	40	45	12		
70	75	60	50	15		
80	100	80	60	15		
90	100	105	65	18		
100	125	125	70	18		
110	125	145	75	20		

Where:  
**V** = Posted Speed Limit  
**A** = Spacing between signs  
**L** = Length of Taper  
**B** = Length of Longitudinal Buffer Space  
**D** = Spacing between Delineation Devices

**Merge taper followed  
by a merge taper**

454.1016.004

## **Restricted areas**

### **Heavy rail ROWs (CN, CP)**

All work that encroaches either the Canadian National (CN) or the Canadian Pacific (CP) rail ROWs shall be co-ordinated through the associated company. For approval and requirements regarding temporary traffic control, contact CN at (800) 665-5662 and CP at (403) 319-7000.

### **Light rail ROWs (LRT)**

Traffic flow at any rail crossing is determined by the rail signals. Do not attempt to control movement of any LRT vehicles except in an emergency.

These basic rules shall be followed when working on all LRT ROWs:

1. All necessary traffic lanes shall be closed before traffic enters the crossing. Traffic shall never be moved from one lane to another while crossing LRT ROWs.
2. Posting of traffic control persons is necessary whenever traffic is diverted across the centre line of the rail crossing. In this case the rail crossing arm does not extend far enough to stop the diverted traffic before entering the crossing.
3. Posting of traffic control persons may be necessary if motorists do not observe the stop lines at the LRT crossing.
4. Do not stop or park vehicles in LRT ROWs.
5. No traffic control devices are to be used on LRT ROWs.
6. Do not stockpile materials on LRT ROWs.
7. If you are experiencing difficulty, do not hesitate to contact Calgary Transit and/or Traffic Engineering.

Calgary Transit shall be notified 48 hours in advance of work performed at, or near an LRT crossing. Contact Calgary Transit Rail Control at 268-1518 to co-ordinate the necessary authorization and the required permits.

### **Seventh Avenue Transit Corridor**

This area requires a special permit be obtained before proceeding with work. Contact Calgary Transit (3-1-1) to obtain the necessary permit. Traffic Engineering will supply and install all the necessary traffic control measures. Traffic Engineering will instruct the foreman or supervisor on site as to maintaining this set-up.

All recommendations made by Calgary Transit shall be implemented. Calgary Transit will determine the type of traffic controls required and will set the extent of disruption allowed.



### **Provincial ROWs**

For work in the Deerfoot Trail ROW or impacting the Deerfoot Trail ROW, phone Alberta Infrastructure and Transportation (297-6311) and ask for the Operations engineer. Note: In cases where lane closures and work are within the Deerfoot Trail ROW, two weeks lead time will be required so that a permit to work in the ROW can be applied for and issued.

### **Stephen Avenue/Barclay malls**

The City of Calgary and the Calgary Downtown Association have entered into a “Management and Operating Agreement” for the Stephen Avenue and Barclay malls. The Calgary Downtown Association is responsible for the issuance of parking and access permits as well as permission for the use of the malls for patio, vending cart and busker purposes. For information regarding the above, please call the Calgary Downtown Association at 215-1570.

All other permits or permission for the use of the malls shall be obtained from The City. Contact Traffic Engineering at 3-1-1.



## Chapter 4 – Guidelines for traffic control devices

### Signs and specifications

Below is a listing of common temporary traffic control signs. The sizes identified are recommended under normal conditions. Sign sizes are dictated by roadway classification or by Traffic Engineering. Refer to The City of Calgary Sign Code Manual for sign sizes and signs that are not identified below. Size colour and shape shall be in accordance with the most current version of the Manual of Uniform Traffic Control Devices for Canada (MUTCD).

All signs, unless otherwise specified, must be retroreflective. Retroreflective sheeting that is classified as Engineering Grade, Reflectivity Level 2 is the minimum intensity for used in temporary traffic control signage. High intensity material (Reflectivity Level 1) is recommended and is The City standard.

For other sign sizes and types commonly used in the city of Calgary, please refer to The City of Calgary Sign Code Manual. Contact Traffic Engineering to obtain information on the Sign Code Manual.

### Legend

Sign name (MUTCD Code) (City of Calgary Sign Code Manual Code)

- Sign description
- Sign size
- Colour information

### Regulatory signs

Regulatory signs are used to identify a traffic regulation that is applicable at a given time or place on a road and to identify the legal requirements. The following codes are used to categorize the various regulatory signs as below:

RA: Right-of-way control signs

RB: Road use control signs

RC: Miscellaneous regulatory signs



#### Stop sign (RA-1) (11-001)

- This sign indicates to drivers that they must come to a complete stop and must not proceed until it is safe to do so.
- 600 mm x 600 mm.
- White text and border on red background.



**Multi-way Stop tab (11-008)**

- This sign indicates there are more than two approaches controlled by stop signs.
- 400 mm x 250 mm.
- White text and border on red background.



**Yield sign (RA-2) (11-002)**

- This sign indicates that drivers must yield the ROW, stop if necessary, and must not proceed until it is safe to do so.
- 750 mm height.
- Red symbol and border on white background.



**Maximum Speed sign (RB-1) (11-020)**

- This sign indicates the maximum legal speed.
- 600 mm x 750 mm.
- Black text and border on white background.



**Maximum Speed Ahead sign (WB-9 modified) (13-065)**

- This sign provides advanced warning of a speed reduction.
- 600 mm x 750 mm.
- Black text and border on yellow background.



**Right/Left Turn Prohibited sign (RB-11R and RB11L)  
(11-806 right prohibited; 11-804 left prohibited)**

- This sign indicates that a right or left turn is prohibited.
- 600 mm x 600 mm.
- Black arrow and border, with red circle and bar on white background.



**Entry Prohibited sign (RB-23) (11-240)**

- This sign indicates that access to vehicular traffic is not permitted.
- 600 mm x 600 mm.
- Black border, red symbol on white background.



**Two-way Traffic sign (RB-24) (11-789)**

- This sign indicates that the section of road is a two-way road.
- 600 mm x 750 mm.
- Black symbol and border on white background.



**Left (Right) Turn Only Lane sign (RB-41R and RB41L modified)  
(11-798 left; 11-799 right)**

- Used on approach to an intersection, this sign indicates to drivers that they must turn from the designated lane at the intersection.
- 600 mm x 600 mm.
- White arrow and border on black background.



**Parking Control sign (RB-51) (03-003)**

- This sign indicates that parking is prohibited at all times on all days and on both sides of the sign. Various prohibitions to times, duration and coverage area can be specified.
- 300 mm x 300 mm.
- Black symbol and arrows with red circle and bar, and black border on white background.



**Stopping Prohibited sign (RB-55) (04-003)**

- This sign indicates that stopping is prohibited at all times on all days and on both sides of the sign. Various prohibitions to times, duration and coverage area can be specified.
- 300 mm x 300 mm.
- Black symbol and arrows with red circle and bar, and black border on white background.



**Sidewalk Closed sign (19-030)**

- This sign indicates that the sidewalk is closed.
- 450 mm x 600 mm.
- Black text and border on orange background.

**Temporary Condition signs**

Temporary Condition signs are used for temporary traffic control and have an orange background with black symbol or text.



**Construction Ahead sign (TC-1) (19-010)**

- This sign indicates advanced warning of a major work zone and are generally used for long-term construction projects.
- 750 mm x 750 mm.
- Black text, symbol and border on an orange background.



**Road Work sign (TC-2) (19-016)**

- This sign indicates that activities such as minor maintenance or utility operations are in progress on or adjacent to the road.
- 750 mm x 750 mm.
- Black symbol and border on an orange background.



**Construction Ends sign (TC-4) (19-012)**

- This sign indicates the end of the workzone.
- 750 mm x 750 mm.
- Black text and border on an orange background.



**Temporary Lane Closed Ahead sign (TC-5) (19-027 left; 19-028 right)**

- This sign indicates that a lane is closed ahead.
- 750 mm x 750 mm.
- Black symbol and border on an orange background.



**Lane Closure Arrow sign (TC-7 modified)**

- This sign indicates that traffic must proceed to the left or right of the closed lane.
- 450 mm x 600 mm.
- Black symbol and border on an orange background.



**Detour Ahead sign (TC-10) (19-009)**

- This sign indicates that traffic will be required to take another road to bypass the temporary road blockage.
- 750 mm x 750 mm.
- Black text, symbol and border on an orange background.



**Detour Direction Markers (TC-11) (19-001 to 19-007)**

- These signs indicate the alternate route to take as a result of a total road closure.
- 600 mm x 600 mm.
- Black text, symbol and border on an orange background.



**Through Traffic Prohibited sign (19-014)**

- This sign indicates a worksite ahead, but allows for local traffic up to the worksite.
- 600 mm x 600 mm.
- Black text and border on an orange background.



**Road Closed sign (19-307)**

- This sign indicates that access is prohibited to all traffic.
- 450 mm x 900 mm.
- Black text and border on an orange background.



**Local Traffic Only sign (19-308)**

- This sign indicates that local traffic is permitted.
- 450 mm x 900 mm.
- Black text and border on an orange background.



**Road Diversion sign (TC13R and TC13L)(19-077)**

- This sign indicates a deviation from the normal road which is 200m in length.
- 750 mm x 750 mm.
- Black symbol and border on an orange background.



**Road Realignment sign (TC-15)**

- This sign indicates the road is realigned from normal.
- 750 mm x 750 mm.
- Black symbol and border on an orange background.



**Lane Realignment sign (TC-16)**

- This sign indicates the realignment of two or more lanes from normal.
- 750 mm x 750 mm.
- Black symbol and border on an orange background.



**Traffic Control Person Ahead sign (TC-21) (19-020)**

- This sign indicates that traffic is controlled by a traffic control person.
- 600 mm x 600 mm.
- Black symbol and border on an orange background.



**Be Prepared To Stop sign (19-021)**

- This sign indicates that the motorist may be required to stop.
- 750 mm x 750 mm.
- Black text and border on an orange background.



**Two-way Traffic Ahead sign (TC-24)**

- This sign indicates the approaching section of road is a two-way road.
- 750 mm x 750 mm.
- Black symbol and border on an orange background.



**Checkerboard sign (TC-30R) (13-157 to 13-160)**

- This sign indicates the termination of a road.
- 750 mm x 750 mm.
- Black symbol and border on an orange background.



**Chevron Alignment sign (TC-31) (19-043 right; 19-042 left)**

- This sign indicates a change in the horizontal alignment of the road.
- 450 mm x 600 mm.
- Black symbol and border on an orange background.



**Road Narrows sign (TC-34)**

- This sign indicates the narrowing of the road.
- 750 mm x 750 mm.
- Black symbol and border on an orange background.



**Grooved Pavement sign (TC-47) (19-048)**

- This sign indicates that the road surface requires attention by motorcycle or bicycle operators.
- 750 mm x 750 mm.
- Black symbol and border on an orange background.



**Pavement Drop-off sign (TC-49) (19-049)**

- This sign indicates that on the approaching section of road, either or both the adjacent lane or shoulder are lower or higher than the driving lane.
- 750 mm x 750 mm.
- Black symbol and border on an orange background.



**Bump sign (TC-51)**

- This sign warns of approaching bump in the road.
- 750 mm x 750 mm.
- Black symbol and border on an orange background.



**Pavement Ends sign (TC-50)**

- This sign indicates that the hard surface road is about to end.
- 750 mm x 750 mm.
- Black symbol and border on an orange background.



**Low Clearance Ahead sign (TC-52)**

- This sign indicates the maximum overhead clearance at bridges and other structures.
- 750 mm x 750 mm.
- Black dimension, arrows and border on an orange background.



**Temporary Hazard marker (19-040)**

- This sign marks the location of a bump in the road.
- 300 mm x 300 mm.
- White border on a red background.





**Truck Entrance sign (TC-54) (19-050 left: 19-051 right)**

- This sign indicates trucks entering the roadway.
- 750 mm x 750 mm.
- Black symbol and border on an orange background.



**Construction marker (TC-62 modified) (19-209)**

- This sign is used to separate the work area from the traffic area.
- 300 mm x 900 mm.
- Orange symbol on a black background.



**Double Fine Area sign**

- This sign advises motorists that speed fines double in the work area
- 600 mm x 600 mm.
- Black text and border on a white background.



**Start/End of Double Fine Area signs**

- These signs identify where the double fine area starts and ends.
- 300 mm x 600 mm each.
- White text on a black background.

The following drawing shows an example of a typical portable sign stand.

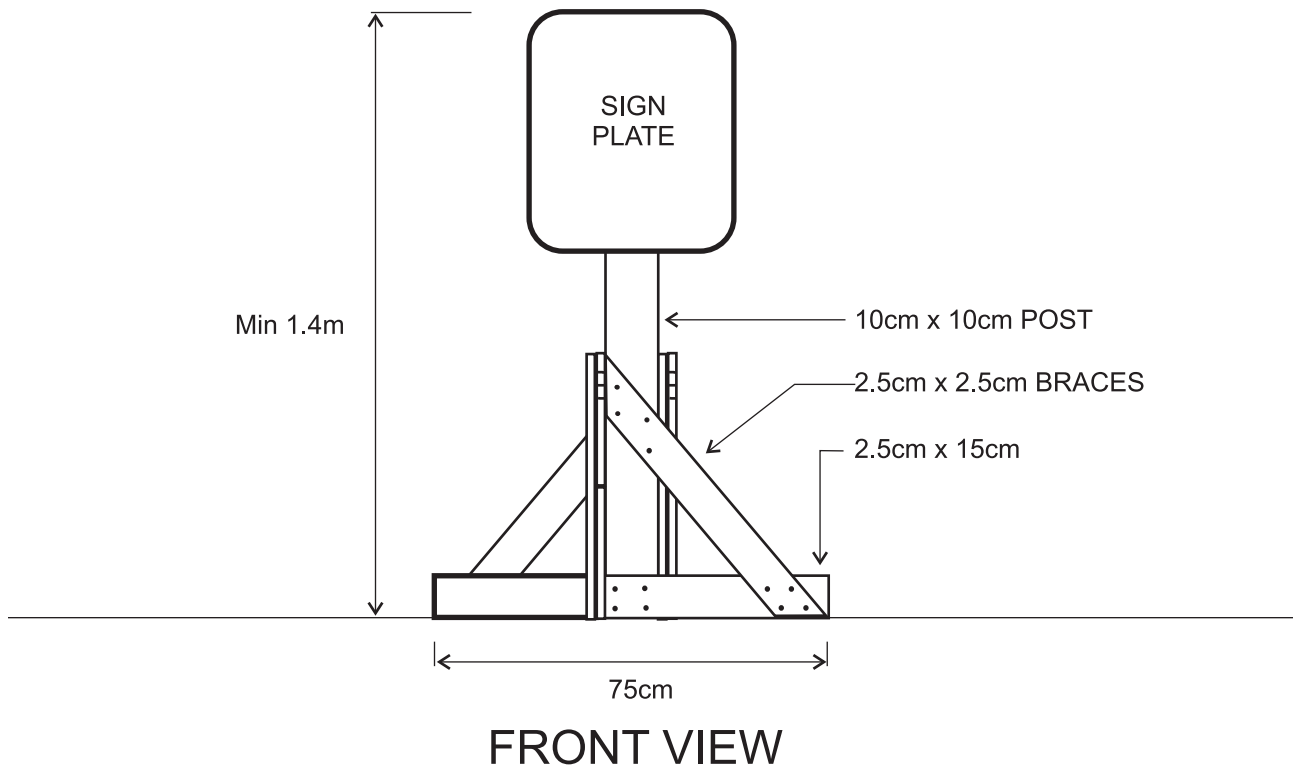

---

**Typical portable sign stand**

454.1016.036

## Control of traffic using a traffic control person

Traffic control persons are required:

1. When two-way traffic has to be guided through a single lane.
2. When materials or equipment are being moved across a travelled lane.
3. To assist motorists through complex traffic control set-ups.
4. When required by Traffic Engineering.

Traffic control persons are responsible for the safety of motorists, pedestrians, their fellow workers and equipment used on the worksite. Therefore, selecting a traffic control person must be based on the individual's experience, alertness and decisiveness. Traffic control persons shall be familiar with flagging standards and procedures as set out by the Alberta Construction Safety Association (ACSA). For more information on courses offered on flagging operations, please contact the ACSA at (1-800-661-6090) or visit <http://www.acsa-safety.org>.

A traffic control person is required to use a "Stop/Slow" paddle during the day. The paddle shall be reflectorized for night use. At night, a red lantern or flashlight must be used in addition to the paddle. A traffic control person must wear an approved hard hat, reflective safety vest and safety shoes as identified by the *Occupational Health and Safety Act*.

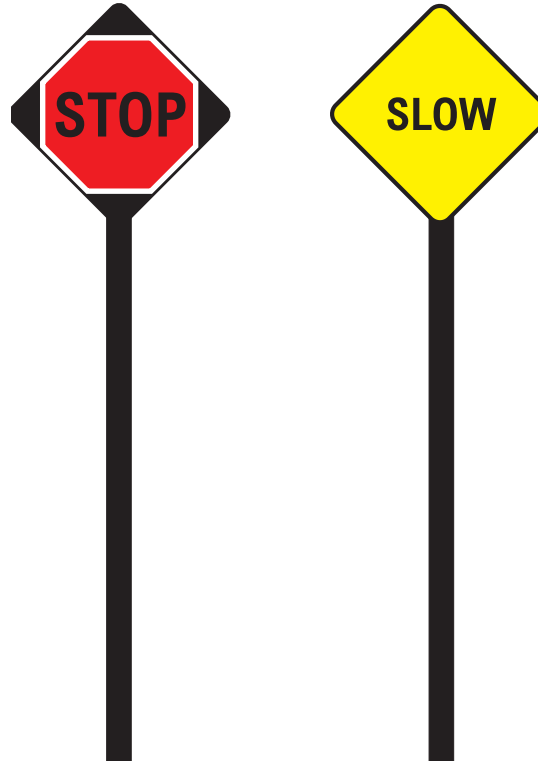

TC-65  
450mm x 450mm

TC-65  
450mm x 450mm

---

### Traffic control paddles

454.1016.037

Illumination should be provided for traffic control persons required to be working in areas where normal street lighting is not available during hours of darkness. Always use a Traffic Control Person Ahead sign (TC-21) and a Be Prepared to Stop sign (19-036) in advance to alert motorists of a flagging operation. Traffic control persons shall stop traffic from the side of the traffic lane and shall never turn their back to traffic. Traffic control persons shall never leave their post until relieved by another traffic control person in full safety apparel.

Each traffic control person shall keep in visual contact with any other traffic control persons on the job. If visual contact cannot be maintained there must be radio contact or a third traffic control person to relay signals. For example, a third traffic control person can relay signals from a position on the middle of a curve, or atop a hill (where visibility is obstructed by horizontal or vertical curves).

Where possible, traffic control persons shall co-ordinate direction of traffic flow with existing traffic signals. If coordination cannot be managed, contact Traffic Engineering a minimum of two working days prior to the flagging operation to arrange with the Signals Division to have the signals changed to an all-red flash mode.

When more than one traffic control person is required at an intersection, traffic shall be moved through the intersection one direction at a time. Use a predetermined clockwise or counter-clockwise rotation to accomplish this.

Certain situations may require the use of the Calgary Police Service (CPS). Contact Traffic Engineering to discuss the need for police involvement. To arrange for pay duty officers, please contact the CPS at 206-2023 or [cpspayduty@calgarypolice.ca](mailto:cpspayduty@calgarypolice.ca).

## **Delineation (Channelization) Devices**

Delineation devices are used to form curves, lines, or boundaries that guide road users to the intended path. The appropriate advanced warning signs shall be used with all delineation devices.

Delineation devices include cones, construction markers, drums, tubular devices and chevron alignment signs. Delineation devices do not include barricades, concrete barriers or signs other than chevron alignment signs.

Traffic cones shall be fluorescent orange and made of rubber or similar flexible material. The minimum height required for cones is 450 mm on roadways with a speed limit of 50 km/h or less, and 700 mm for speeds up to 60 km/h. For use on roadways where the speed is 70 km/h or greater, drums shall be used. Tubular markers may be used for tangent sections on roadways (70 km/h or greater) provided recommended spacing is adopted (refer to typical set-ups for required spacing).

Construction markers may be used for delineation devices, however, they are not recommended. Drums for high volume/high speed roadways, or cones for lower speed roadways are the preferred methods as indicated above. Drums shall be constructed of a material that does not create a hazard to vehicles on impact and should be manufactured so as not to roll.

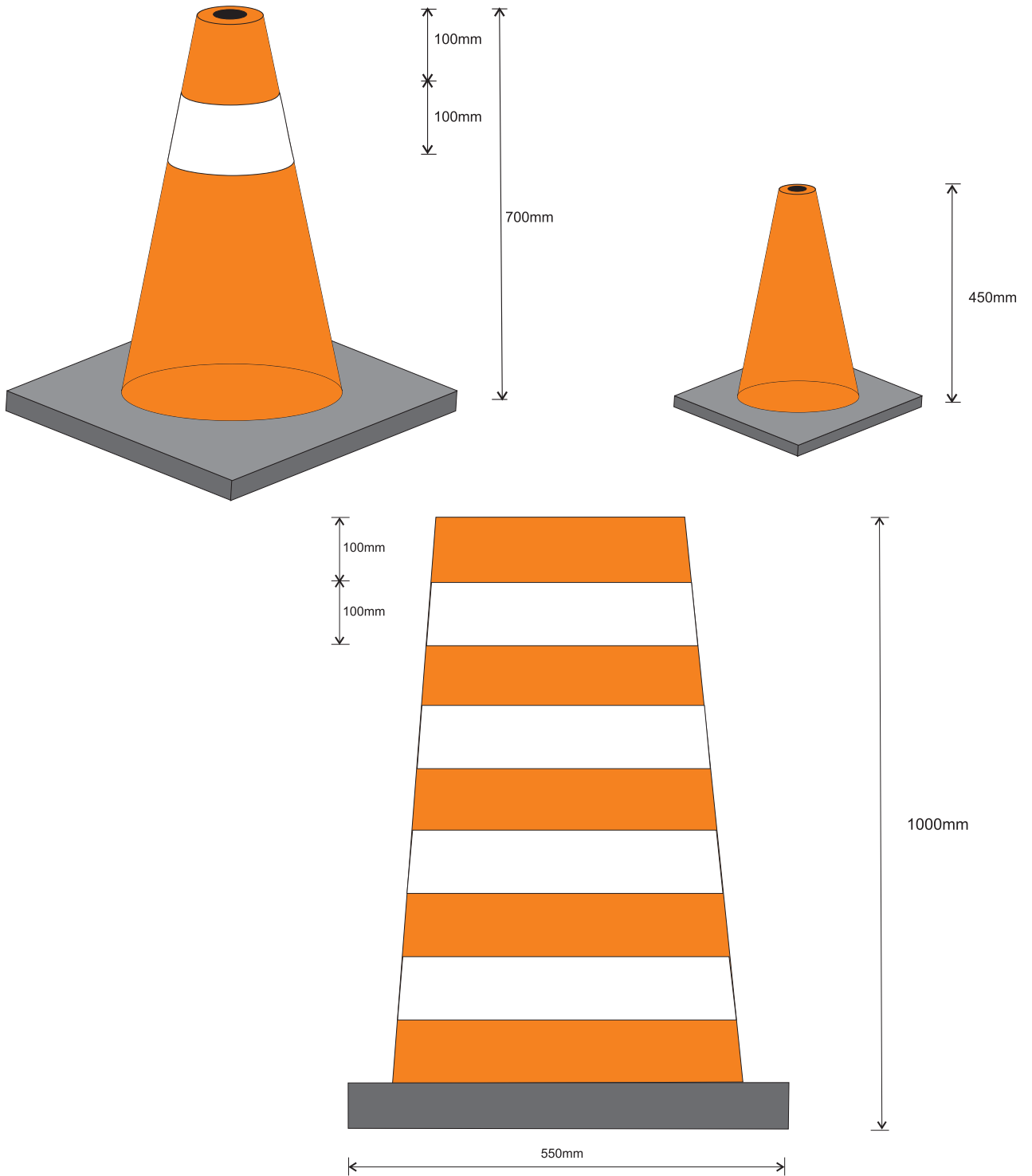

**Delineation devices**

454.1016.038

Chevron alignment signs may be used to provide additional guidance on the outside of curves or sharp turns.

Amber flashers/warning lights shall be used to identify obstructions at night. There are three main types of lights for the purpose of temporary traffic control:

- a. Type A: low intensity flashing lights for nighttime use.
- b. Type B: high intensity flashers are effective day and night.
- c. Type C: steady burn, low-wattage lights are used at night for delineation.

Additional consideration should be given for nighttime work. Nighttime work can expedite the work, reducing the disruption of traffic. If floodlights are used for nighttime work, care should be taken so as not to impair the vision of approaching motorists.

## Barricades

Proper placement of barricades is necessary to ensure public safety. Barricades are a potential hazard. The following provides some examples of acceptable and non-acceptable use of barricades:

### Acceptable use of barricades

- Barricades shall face oncoming vehicular traffic.
- Barricades are used to outline hazardous work areas and to prevent vehicles and pedestrians from entering the work area.
- Barricades are used to warn of an activity area and to obstruct entry into an activity area.
- Temporary signage may be placed on barricades only if necessary to accommodate a modified Lane Closure arrow, Road Closed or No Through Traffic signs.
- Barricades shall be used to close a road.

### Non-acceptable use of barricades

- Barricades shall **not** be used as a delineation device.
- Barricades shall **not** be placed parallel to the flow of traffic. (For example, they are not to be used to mark the boundary between a travel lane and the work area or separate adjacent lanes of traffic.)
- Barricades shall **not** be placed in oncoming traffic without necessary advanced warning devices and signs.
- Barricades shall **not** be used instead of signposts.
- Barricades shall **not** be used for the placement of regulatory signs.
- Barricades shall **not** be located within the buffer area.

Light barricades (as shown)

- A light barricade is a portable device that typically has one rail.
- Light barricades may be used for road, street, lane or shoulder closures of short duration.
- Light barricades should be stabilized using sandbags placed on the lower section of the frame. Under no circumstances shall they be placed over the rail of the barricade.

Heavy barricades (as shown)

- A heavy barricade typically has three rails and is more permanent in nature as compared to a light barricade.
- Heavy barricades shall be used for road, street, lane or shoulder closures of long duration.
- Heavy barricades may be used for road closures of short duration.

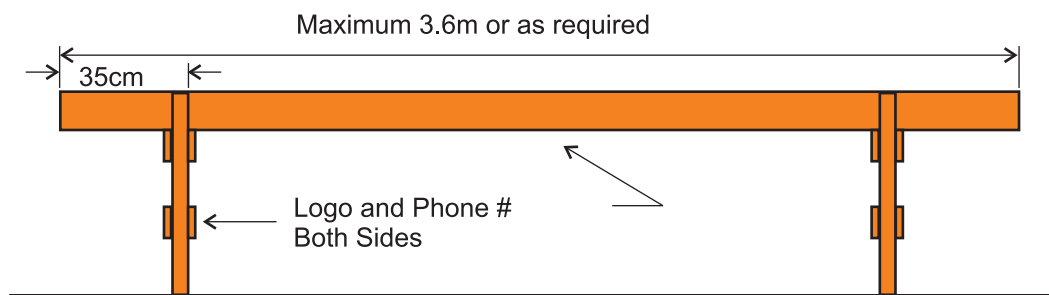

ELEVATION

COLOUR: ORANGE

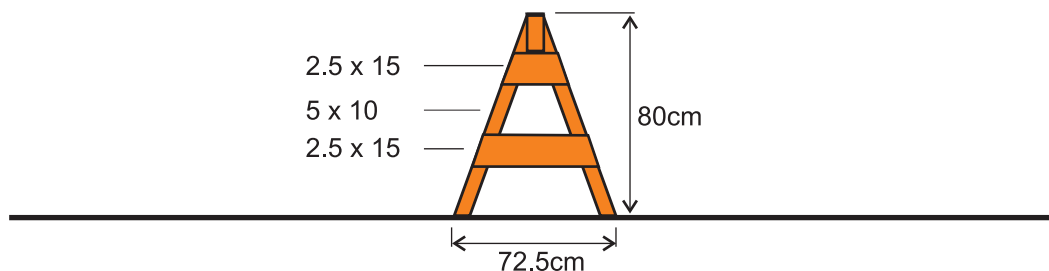

END VIEW

**Typical light barricade  
(temporary)**

454.1016.039

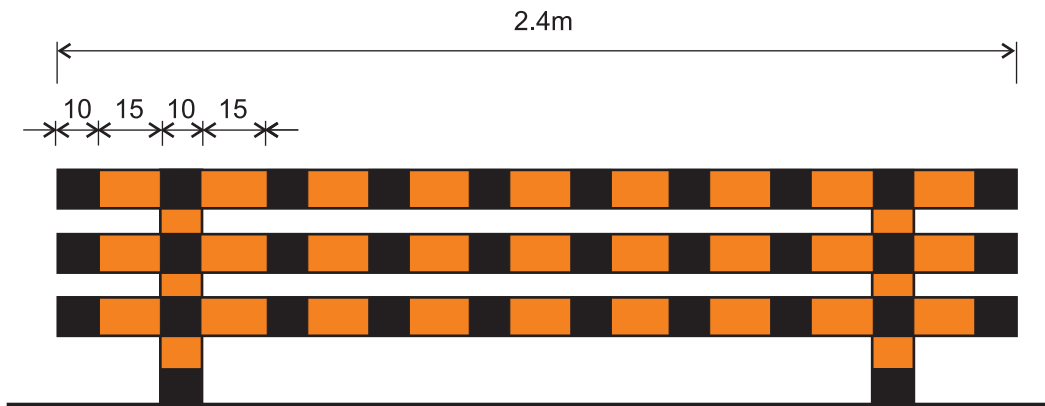

### ELEVATION

COLOUR: ORANGE WITH BLACK STRIPES  
15cm WIDE ORANGE  
10cm WIDE BLACK

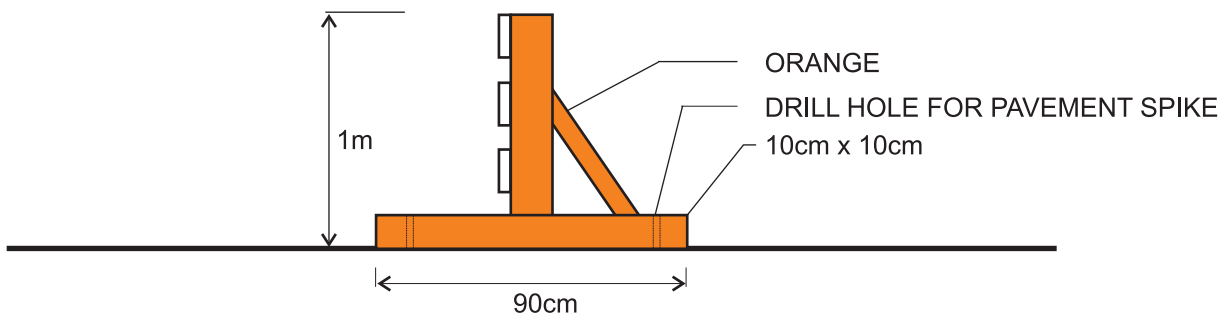

### END VIEW

## Typical heavy barricade (permanent)

---

454.1016.040



## **Traffic barriers**

Longitudinal traffic barriers are used in work zones to:

- Limit the possibility of traffic entering the work area.
- Protect the workers.
- Separate traffic.
- Protect the construction site.
- Separate pedestrians from vehicular traffic.

The use, placement and maintenance of longitudinal barriers should be based on acceptable engineering practices. Traffic barriers should:

- Be placed continuously without gaps between sections.
- Have acceptable flare rates on the leading edge, or have appropriate end treatments (e.g. impact attenuators).
- Be equipped with glare screens where necessary.
- Be placed 0.6 m from the edge of the driving lane.
- Be used during periods of inactivity where excavations compromise safety.

For information on temporary concrete barriers and acceptable barriers, refer to the following website:

[http://safety.fhwa.dot.gov/fourthlevel/pro\\_res\\_road\\_nchrp350.htm](http://safety.fhwa.dot.gov/fourthlevel/pro_res_road_nchrp350.htm).

For acceptable applications and installation requirements, please refer to Chapter 9 of the “Roadside Design Guide, American Association of State Highway and Transportation Officials, 2002.”

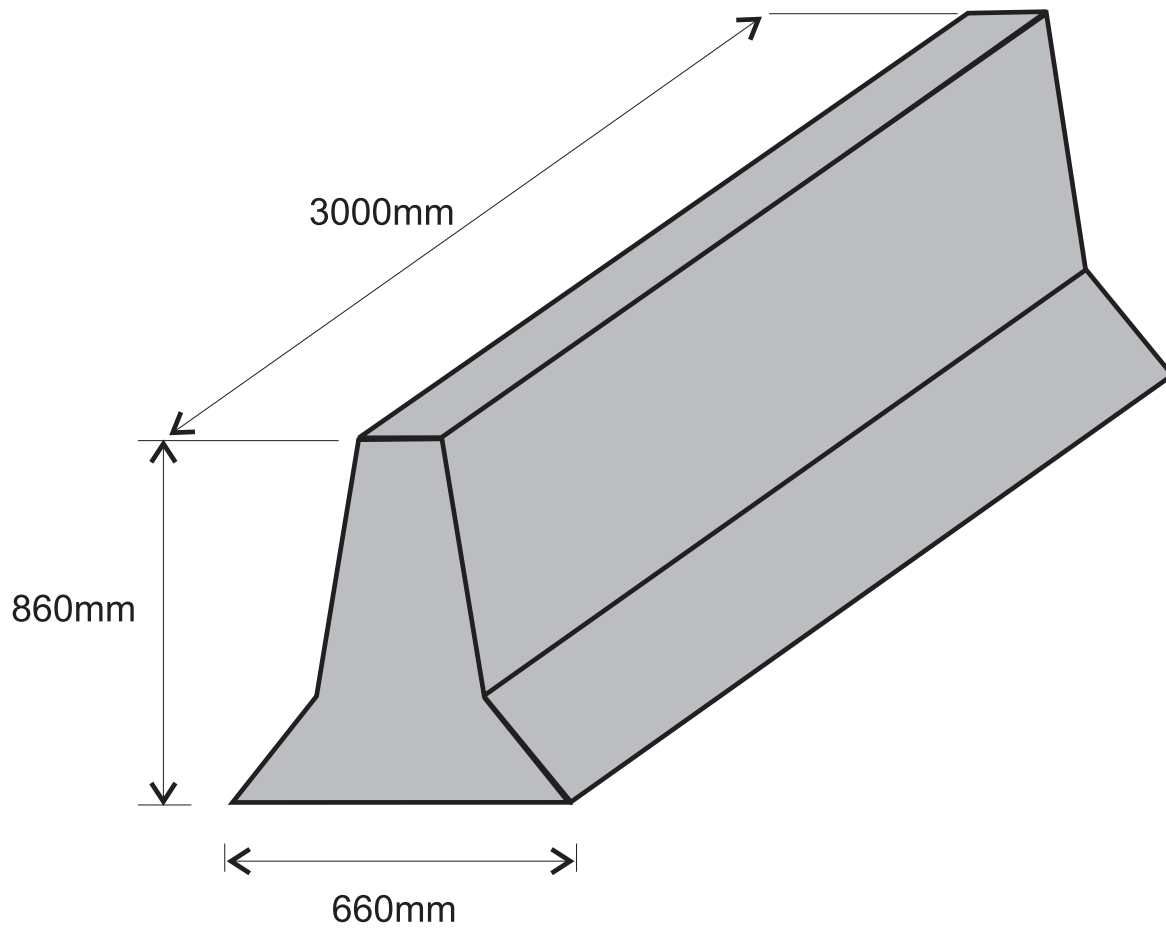

Standard Concrete  
Barrier

---

## Types of barriers

454.1016.041

## Arrow boards

Arrow boards are a safe and effective method of traffic control when used as intended. They are not to take the place of advance warning signs or delineation devices. When combined with the use of advanced warning signs and delineation devices, arrow boards are very effective. They are especially useful in situations that require higher than normal visibility. Examples where arrow boards should be used are on overnight set-ups, high-speed, high volume roadways (70 km/h and greater) and in poor weather conditions. It is important to note that arrow boards used for nighttime applications should be less bright than during daytime operations so as not to impair the vision of approaching motorists.

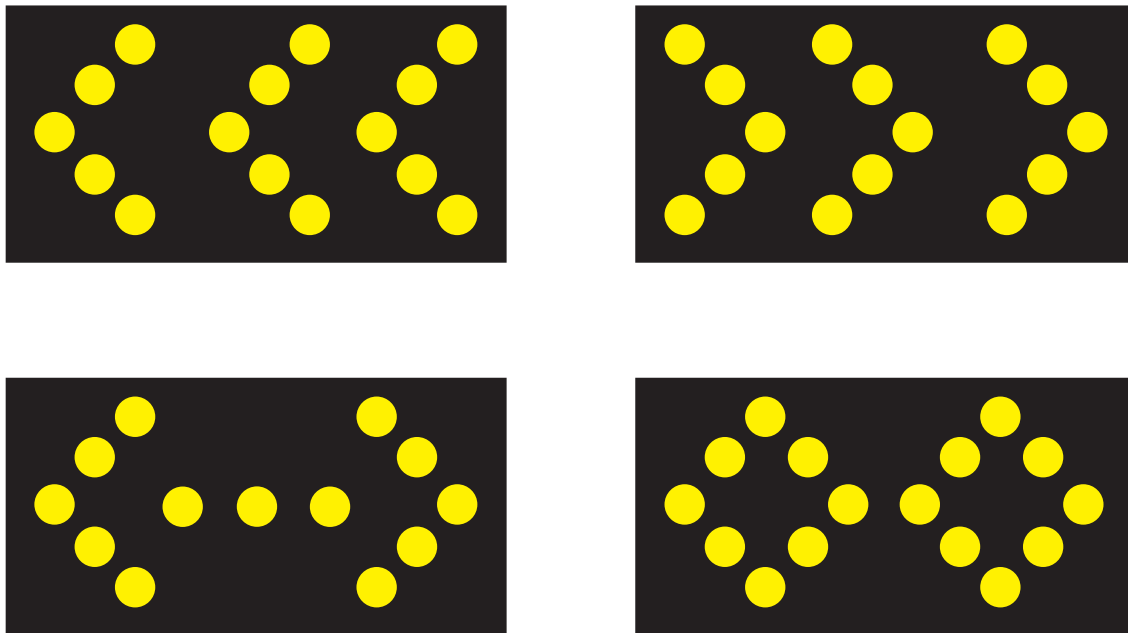

## Variable message boards

Variable message boards are used to relay information to motorists for upcoming or existing road construction. Typically these are used on high-volume roadways where road construction is expected to cause delays. For example, they are used to advise motorists to expect delays or use alternative routes where possible. Variable message boards are more effective at capturing the attention of the road users than static signs. Variable message boards should be programmed so motorists are able to read the message twice given the posted speed.

## Impact attenuators

Impact attenuators (also known as crash cushions) are used to prevent an errant vehicle from impacting a fixed object by controlled deceleration. Impact attenuators in temporary traffic control zones protect the motorists from the exposed ends of barriers, fixed objects and other hazards. There are two types of attenuators commonly used for temporary traffic control: (1) stationary, and (2) truck mounted (or mobile). Truck mounted attenuators (TMAs) are mounted on the rear of a crash truck and deforms on impact in a controlled manner.

Stationary attenuators are recommended for long-term situations, while TMAs are preferable for short-term or mobile operations. For more information on the use and types of these devices, refer to the "Roadside Design Guide, American Association of State Highway and Transportation Officials, 2002."

## Intelligent Transportation Systems (ITS) applications

Intelligent transportation systems can improve the safety of the workers and the motorists, and reduce driver frustration through work zones. There are many products available to assist in achieving these goals. Below are some examples of ITS and some typical applications:

- Over height vehicle detection systems  
These could be used in situations where bridge maintenance requires falsework, thereby reducing the normal clearance of a bridge. These systems typically use sensors to identify approaching over height vehicles and alert the drivers of the restricted clearance.
- Work zone intrusion sensors/alarms  
These systems are used to prevent crashes and injuries in work zones by alerting both the workers and the errant vehicle drivers of an intrusion into the work zone.
- Advanced Travellers Information System (ATIS)  
These can be used to inform drivers of expected delays, caution drivers to reduce speed, advise motorists of closures, and provide information on alternate routes.
- Dynamic work zone systems  
These systems promote smooth traffic flow leading into a work zone by creating a dynamic no passing zone upstream of the work zone. ITS monitoring systems detect speed and volume to adapt the length of the zone to changing traffic conditions. The dynamic system deters vehicles from attempting to get ahead in the line by changing lanes at the last possible opportunity.

The above systems are just a few examples of intelligent information systems that are available for use for temporary traffic control.

## Speed Fines Double

An amendment to Alberta's *Traffic Safety Act* was made to encourage motorists to adhere to the speed limit in active work areas. Active work areas must be kept as short as possible, and only extend where actually needed to improve speed limit compliance.

If used, the active work area Speed Fines Double sign and Begins sign must be set up below, or immediately in front of, the Maximum Speed sign. The double fine area will terminate at the Speed Fines Double and Ends signs.

The Speed Fines Double, Begins and Ends signs must be used to mark the extents of active work areas in high speed situations (70 km/h or greater). Active work areas with lower speeds, such as residential areas, may not have these signs. In addition, work areas set up for long duration projects must receive Speed Fines Double, Begins and Ends signs, but areas set up for temporary work may not receive the signs.

Speed Fines Double, Begins and Ends signs must be covered or removed when workers are not present. No double fines will be issued during these times. Motorists can be issued double fines regardless of whether or not Speed Fines Double signs are installed, provided that workers are present or it is anticipated that workers will be present, as it is an active work area.

A construction zone can be composed of more than one active work area. In this situation, more than one double fine area may exist within a given construction zone. In this case, the extent of each double fine area will coincide with Maximum Speed signage used to mark the extent of each active work area.

## Chapter 5 – Temporary traffic control (typical applications)

This chapter deals with how signs and devices are used for temporary conditions. Since they cannot cover all site-specific conditions, the examples provided here are labelled as typical applications. These typical applications provide the user with the minimum requirements for temporary traffic control.

### Drawing index

1.	Roadside work. . . . .	45
2.	Work adjacent to a roadway. . . . .	47
3.	Shoulder work. . . . .	49
4.	Work on edge of roadway. . . . .	51
5.	Two-way flagging operation . . . . .	53
6.	Yield to oncoming traffic . . . . .	55
7.	Single right lane closure. . . . .	57
8.	Single left lane closure . . . . .	59
9.	Speed fines double with right lane closure . . . . .	61
10.	Multi-lane closure two right lanes . . . . .	63
11.	Multi-lane closure two left lanes . . . . .	65
12.	Multi-lane closure left lane closed in each direction . . . . .	67
13.	Centre line cross-over two-way traffic . . . . .	69
14.	Median cross-over two-way traffic . . . . .	71
15.	Intersection work example 1 . . . . .	73
16.	Intersection work example 2 . . . . .	75
17.	Intersection work example 3 . . . . .	77
18.	Intersection work example 4 . . . . .	79
19.	Intersection work example 5 . . . . .	81
20.	Intersection work example 6 . . . . .	83
21.	Back lane closures. . . . .	85
22.	Road closure . . . . .	87
23.	Road diversion two directions . . . . .	89
24.	Shoulder detour . . . . .	91
25.	Sidewalk closure . . . . .	93
26.	Moving jobs . . . . .	95
27.	Road bridging . . . . .	97
28.	Speed fines double . . . . .	98

## **1. Roadside work**

### **1. Example shown**

Two-lane – two-way street without shoulder (residential).

No encroachment onto road.

### **2. Conditions**

Worksite must be in the boulevard area, completely off the road.

Excavations require protection (refer to Chapter 3; securing the worksite).

### **3. Observations**

Note use of advance warning sign.

### **4. Set-up procedure**

Set up advance warning sign and then cones.

Commence work.

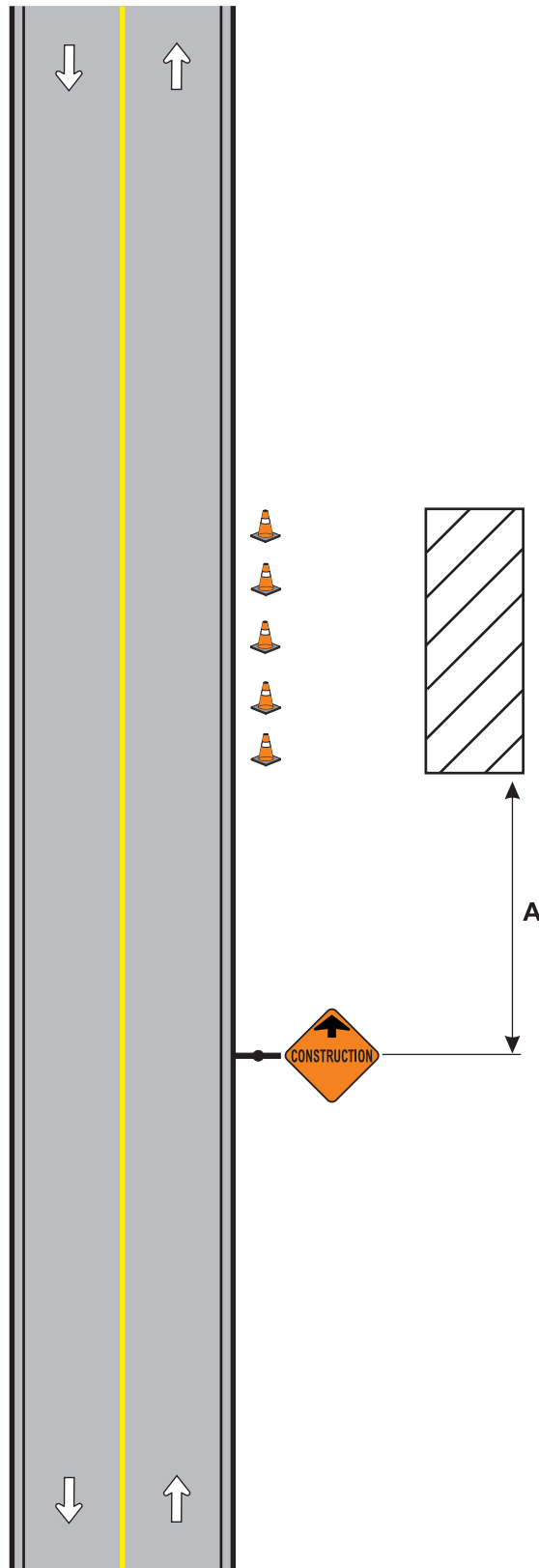

**Note:**  
 This drawing is a graphical representation of the detour setup. It is **not** drawn to scale.

V(km/h)	A(m)	L(m)	B(m)	D(m)		
50	50	30	35	8		
60	50	40	45	12		
70	75	60	50	15		
80	100	80	60	15		
90	100	105	65	18		
100	125	125	70	18		
110	125	145	75	20		

Where:  
**V** = Posted Speed Limit  
**A** = Spacing Between Signs  
**L** = Length of Taper  
**B** = Length of Longitudinal Buffer Space  
**D** = Spacing Between Delineation Devices

## 1. Roadside work

454.1016.005

## **2. Work adjacent to a roadway**

### **1. Example shown**

Two-lane – two-way street without shoulder (residential).

No encroachment onto road.

### **2. Conditions**

Worksite must be in the boulevard area, completely off the road.

Excavations require protection.

### **3. Observations**

Note use of advance warning sign.

### **4. Set-up procedure**

Set up advance warning sign and then cones.

Commence work.



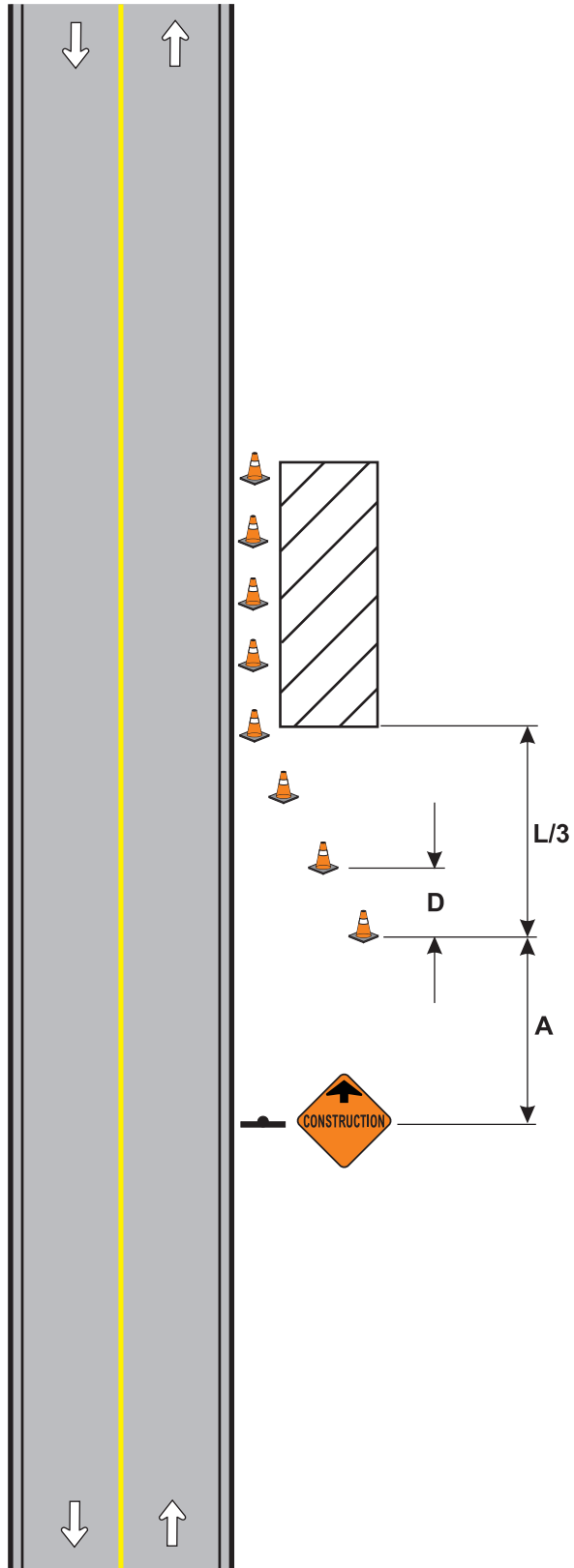

**Note:**  
 This drawing is a graphical representation of the detour setup. It is **not** drawn to scale.

V(km/h)	A(m)	L(m)	B(m)	D(m)	
50	50	30	35	8	
60	50	40	45	10	
70	75	60	50	15	
80	100	80	60	15	
90	100	105	65	18	
100	125	125	70	18	
110	125	145	75	20	

Where:  
**V** = Speed Limit  
**A** = Spacing between signs  
**L** = Length of Taper  
**B** = Length of Longitudinal Buffer Space  
**D** = Spacing between Delineation Devices

## 2. Work adjacent to a roadway

454.1016.006

### **3. Shoulder work**

#### **1. Example shown**

Two-lane – two-way street with parking lane/shoulder.

No encroachment in lane.

#### **2. Conditions**

Approaching traffic must be able to pass by worksite while remaining completely within their own lane.

#### **3. Observations**

Applies to sidewalk or curb and gutter repairs.

#### **4. Set-up procedure**

Set up advance warning sign.

Set up Lane Closure Arrow sign.



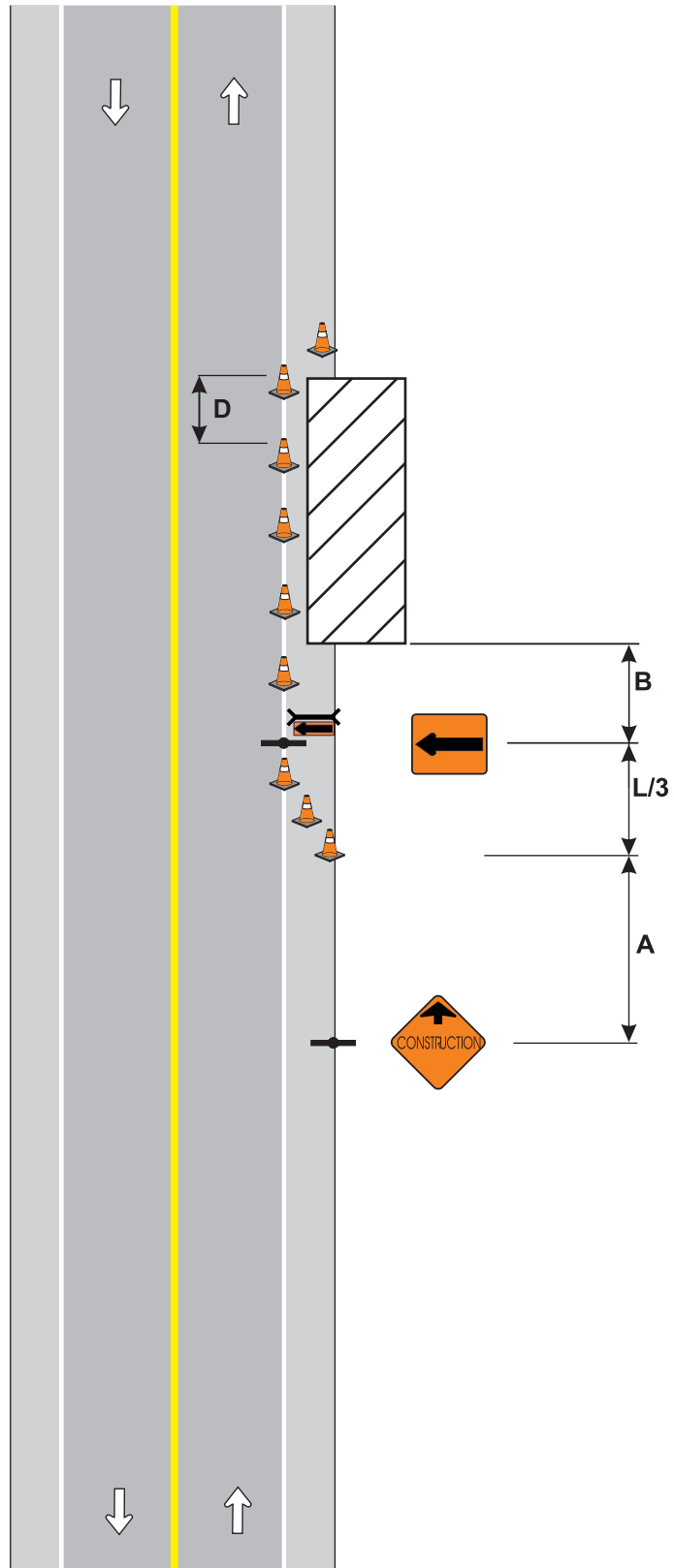

Set up taper and outline worksite with cones.

Commence work.



**Note:**

This drawing is a graphical representation of the detour setup. It is **not** drawn to scale.

V(km/h)	A(m)	L(m)	B(m)	D(m)		
50	50	30	35	8		
60	50	40	45	12		
70	75	60	50	15		
80	100	80	60	15		
90	100	105	65	18		
100	125	125	70	18		
110	125	145	75	20		

Where:

- V = Posted Speed Limit
- A = Spacing Between Signs
- L = Length of Taper
- B = Length of Longitudinal Buffer Space
- D = Spacing Between Delineation Devices

### 3. Shoulder work

454.1016.007

## **4. Work on edge of roadway**

### **1. Example shown**

Two-lane – two-way street parking lane.

Encroachment in right lane.

### **2. Conditions**

Approaching traffic must be diverted into oncoming traffic.

### **3. Observations**

Two lanes of 3 m minimum width must be available (bus routes require more width). If this condition cannot be met, refer to two-way flagging operation.

### **4. Set-up procedure**

Set up No Parking zone first and have it inspected by the Calgary Parking Authority 12 hours prior to restriction.

Start at top of diagram. Set up advance warning signs for southbound lane in order shown.

Set up cones and two-way traffic signs separating the two lanes.

Start at bottom of diagram. Set up right northbound lane advance warning signs and taper in order shown.

Outline worksite with cones.

Commence work.

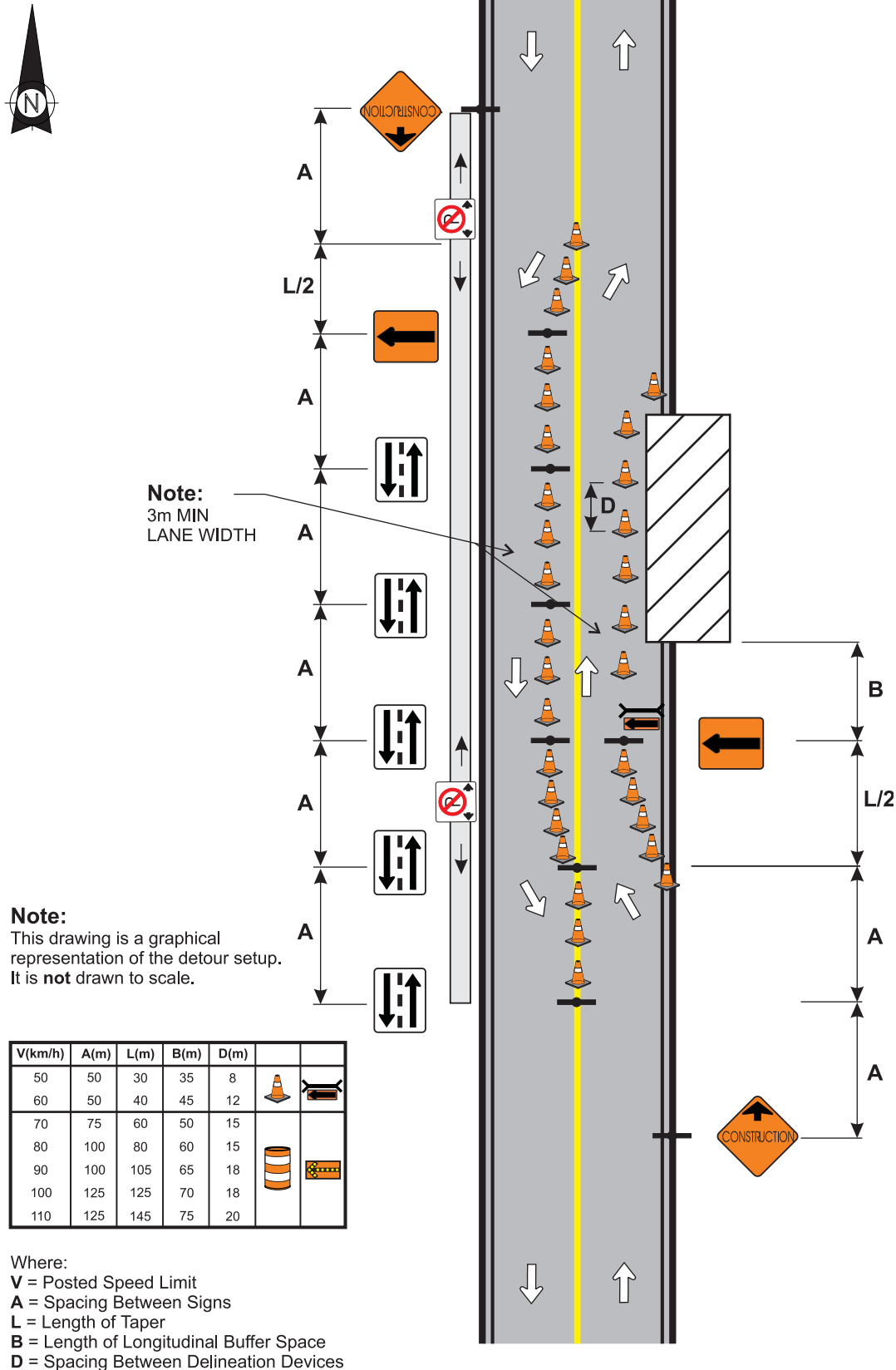

#### 4. Work on edge of roadway

454.1016.008

## 5. Two-way flagging operation

### 1. Example shown

Two-lane – two-way street.

### 2. Conditions

One lane of traffic will be completely blocked. May extend worksite into second lane provided enough space for traffic to drive by work site (min. 3 m).

### 3. Observations

For speeds in excess of 50 km/h, a speed reduction set-up is required.

Flagger on upper left of diagram must stop traffic far enough back to allow oncoming traffic access to northbound lane.

Recommend installing no parking zones on both sides of road.

### 4. Set-up procedure

Set up No Parking zone first. Have inspected by the Calgary Parking Authority 12 hours (min) prior to restriction.

Set up advance warning signs on both sides in order shown.

Post traffic control persons.

Set up taper and outline worksite with cones.

Commence work.

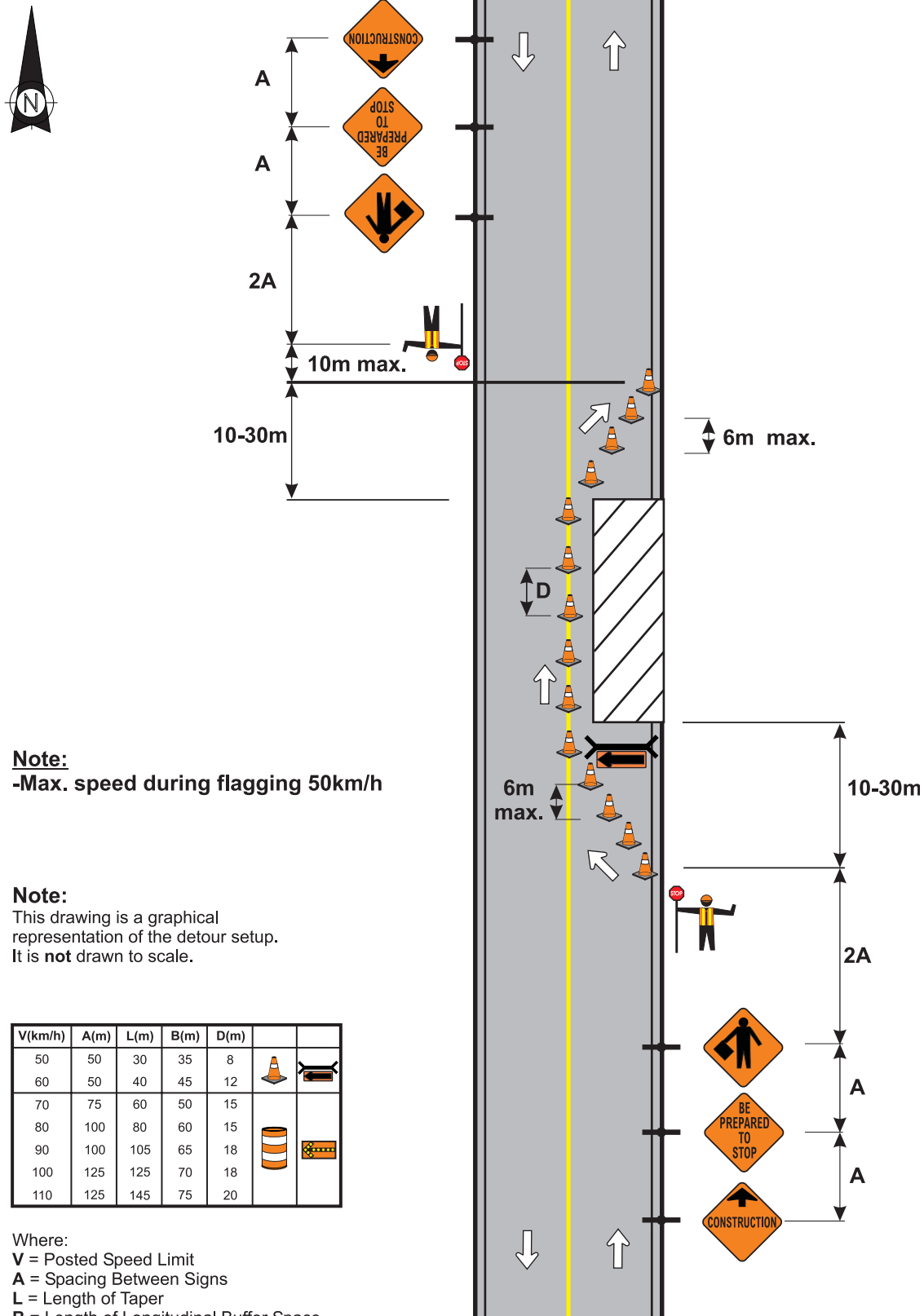

**Note:**  
-Max. speed during flagging 50km/h

**Note:**  
This drawing is a graphical representation of the detour setup. It is **not** drawn to scale.

V(km/h)	A(m)	L(m)	B(m)	D(m)		
50	50	30	35	8		
60	50	40	45	12		
70	75	60	50	15		
80	100	80	60	15		
90	100	105	65	18		
100	125	125	70	18		
110	125	145	75	20		

Where:  
**V** = Posted Speed Limit  
**A** = Spacing Between Signs  
**L** = Length of Taper  
**B** = Length of Longitudinal Buffer Space  
**D** = Spacing Between Delineation Devices

## 5. Two-way flagging operation

454.1016.009

## **6. Yield to oncoming traffic**

### **1. Example shown**

Two-lane – two-way street.

### **2. Conditions**

Single lane closure.

Residential street – low volume roads only.

### **3. Observations**

Used for securing a worksite during periods of inactivity. During working hours, refer to two-way flagging operation.

Overnight set-up requires use of flashers. (Refer to Chapter 4; Delineation (Channelization) devices for flasher use.)

### **4. Set-up procedure**

Set up No Parking zone and have inspected by the Calgary Parking Authority 12 hours (minimum) prior to restriction.

Start at top of diagram. Set up advance warning sign for the southbound lane.

Start at bottom of diagram. Set up advance warning signs in order shown. Set up taper and outline work site with cones.

Commence work.



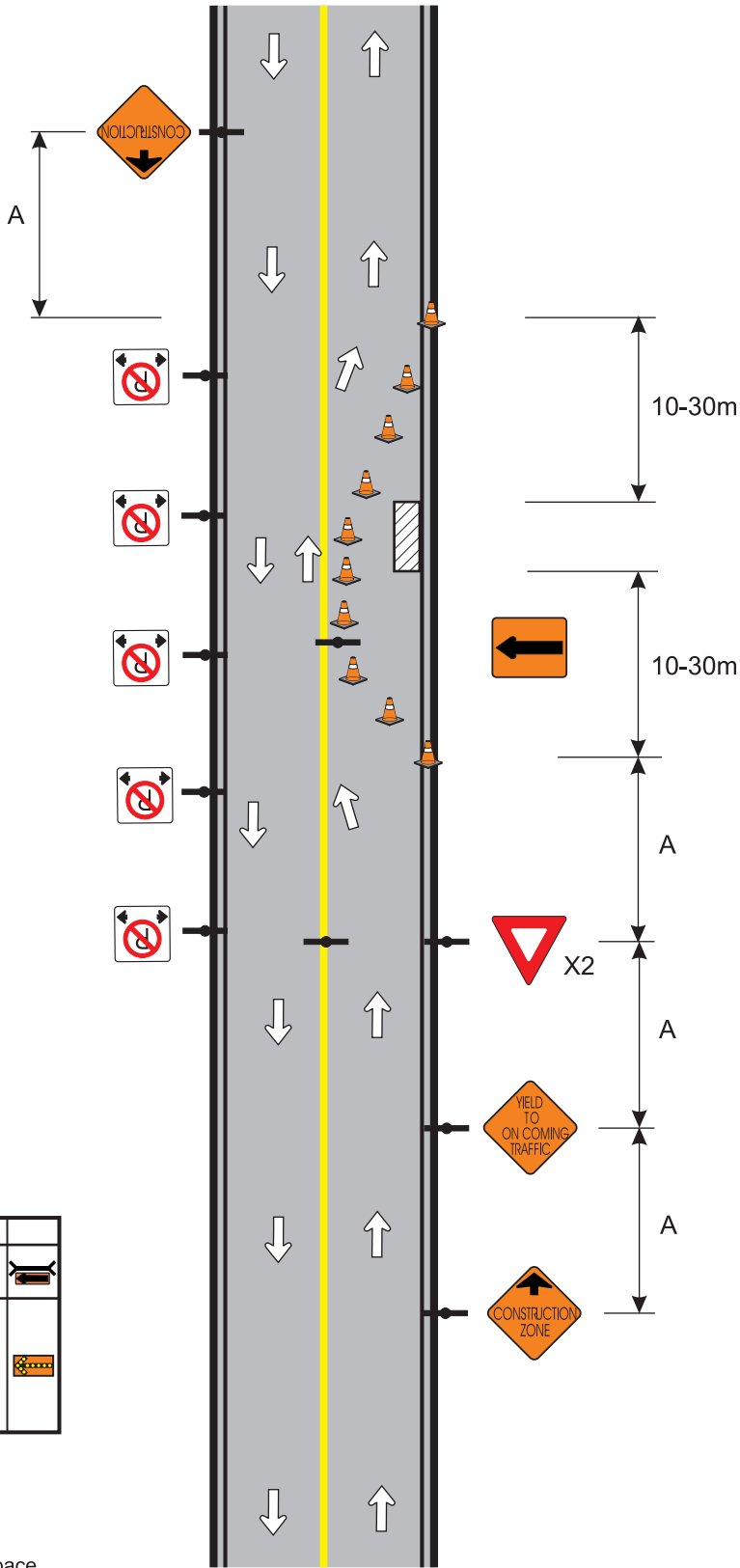

**Note:**  
 This drawing is a graphical representation of the detour setup. It is **not** drawn to scale.

V(km/h)	A(m)	L(m)	B(m)	D(m)		
50	50	30	35	8		
60	50	40	45	12		
70	75	60	50	15		
80	100	80	60	15		
90	100	105	65	18		
100	125	125	70	18		
110	125	145	75	20		

Where:  
**V** = Speed Limit  
**A** = Spacing between signs  
**L** = Length of Taper  
**B** = Length of Longitudinal Buffer Space  
**D** = Spacing between Delineation Devices

### 6. Yield to oncoming traffic

## **7. Single right lane closure**

### **1. Example shown**

Two-way – four-lane street.

### **2. Conditions**

Closure of single lane.

### **3. Observations**

Note two Right Lane Closed signs to allow more reaction time for motorists to change lanes.

### **4. Set-up procedure**

Start at bottom of diagram. Set up advance warning signs in order shown.

Set up taper and outline worksite with cones.

Commence work.

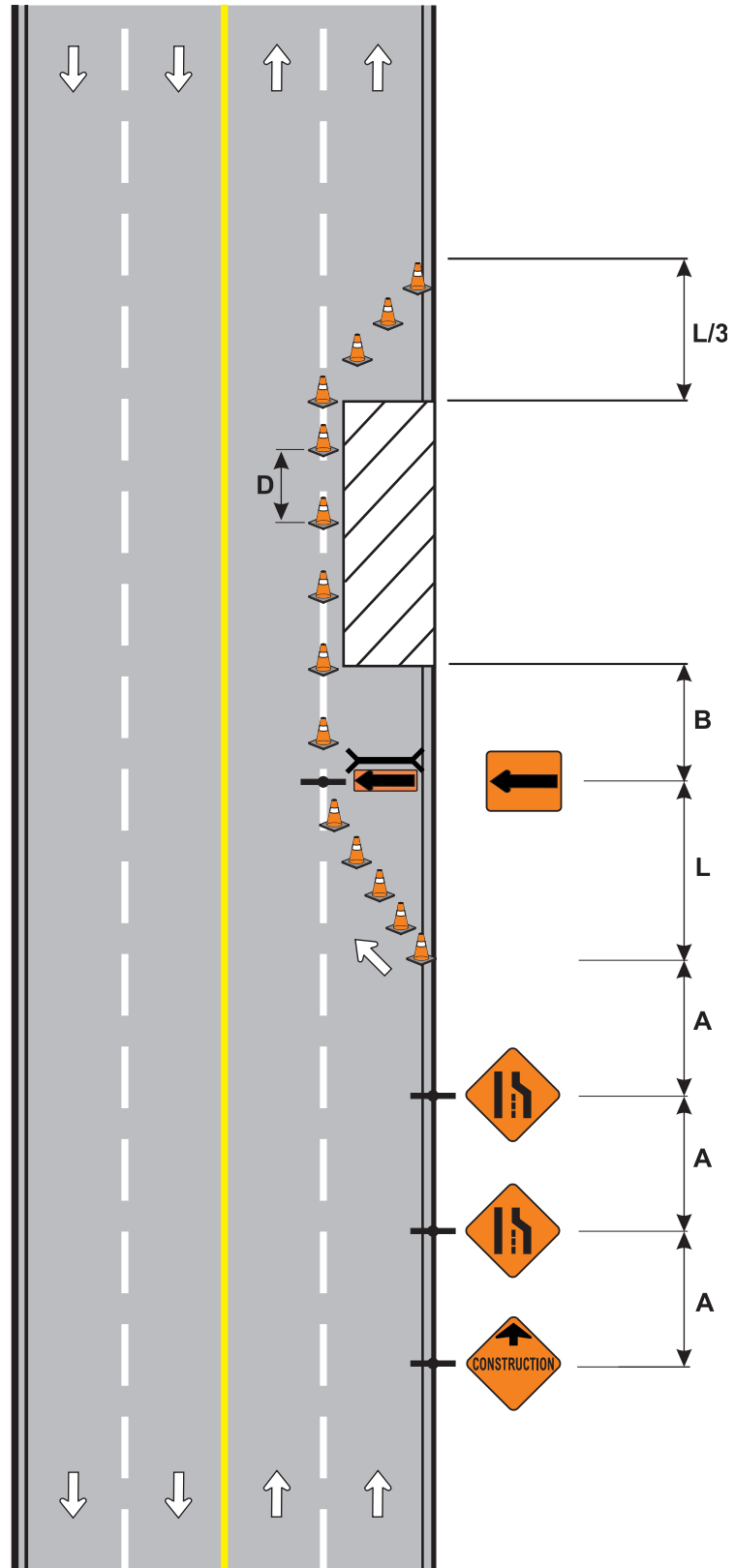

**Note:**

This drawing is a graphical representation of the detour setup. It is **not** drawn to scale.

V(km/h)	A(m)	L(m)	B(m)	D(m)		
50	50	30	35	8		
60	50	40	45	12		
70	75	60	50	15		
80	100	80	60	15		
90	100	105	65	18		
100	125	125	70	18		
110	125	145	75	20		

Where:

**V** = Posted Speed Limit

**A** = Spacing Between Signs

**L** = Length of Taper

**B** = Length of Longitudinal Buffer Space

**D** = Spacing Between Delineation Devices

## 7. Single right lane closure

454.1016.011

## **8. Single left lane closure**

### **1. Example shown**

Two-way – four-lane street.

### **2. Conditions**

Closure of single lane.

### **3. Observations**

Note signing on centre line of road.

Rectangular “text” lane closure signs may be used where conditions do not allow for diamond-shaped signs.

### **4. Set-up procedure**

Start at bottom of diagram. Set up advance warning signs in order shown.

Set up taper and outline worksite with cones. Set up sign at top of diagram.

Commence work.

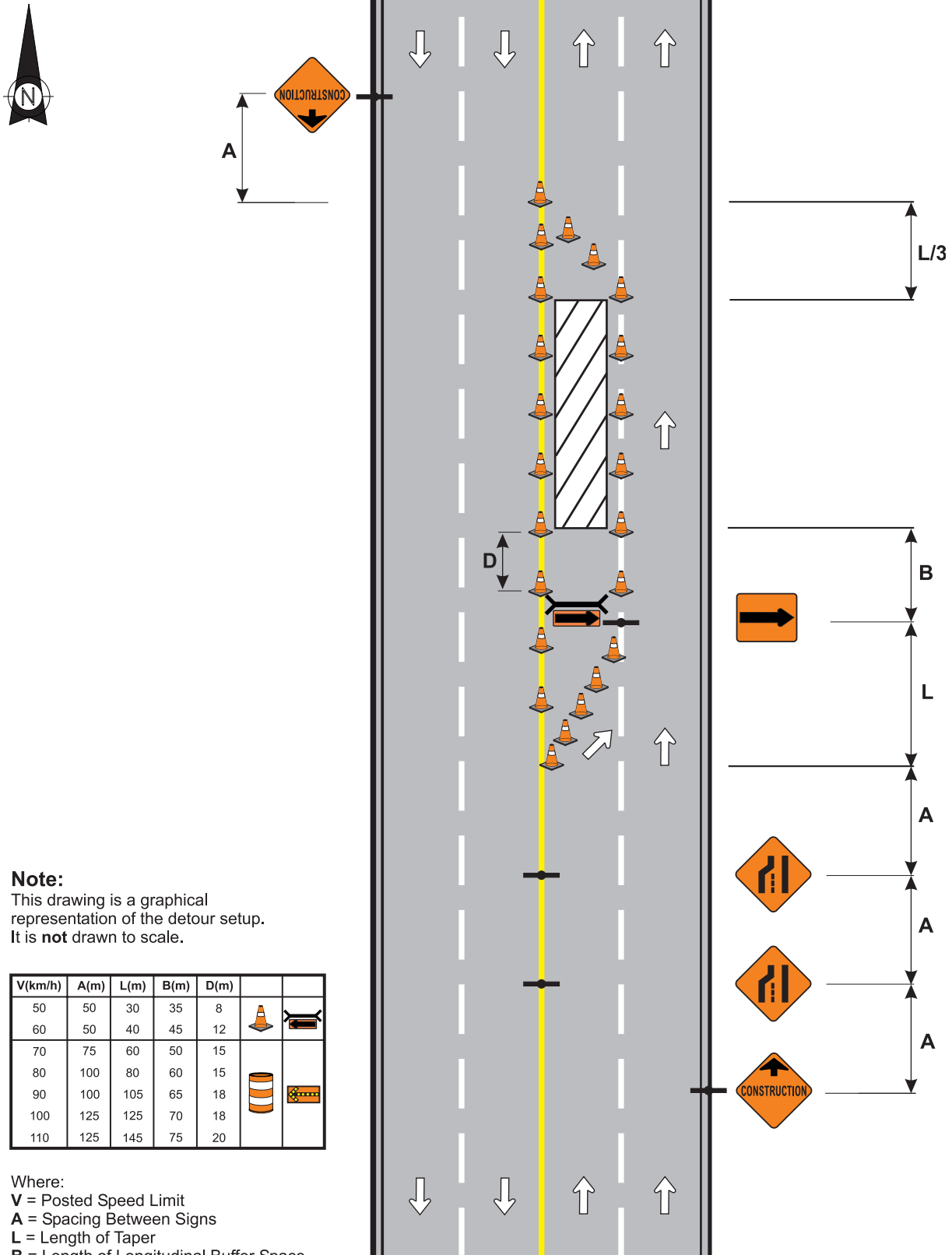

**Note:**  
This drawing is a graphical representation of the detour setup. It is **not** drawn to scale.

V(km/h)	A(m)	L(m)	B(m)	D(m)		
50	50	30	35	8		
60	50	40	45	12		
70	75	60	50	15		
80	100	80	60	15		
90	100	105	65	18		
100	125	125	70	18		
110	125	145	75	20		

Where:  
**V** = Posted Speed Limit  
**A** = Spacing Between Signs  
**L** = Length of Taper  
**B** = Length of Longitudinal Buffer Space  
**D** = Spacing Between Delineation Devices

## 8. Single left lane closure

454.1016.012

## **9. Speed reduction with right lane closure**

### **1. Example shown**

Divided two-way, four-lane street.

### **2. Conditions**

Closure of right lane.

### **3. Observations**

Note two Right Lane Ends and use of arrow board signs to allow more reaction time for motorists to change lanes.

Note Construction Ahead, 70 Ahead and Maximum 70 signs are used on both sides of the roadway.

### **4. Set-up procedure**

Start at bottom of diagram.

Set up advance warning signs in order shown.

Set up taper and outline worksite with cones.

Commence work.



**Note:**

This drawing is a graphical representation of the detour setup. It is not drawn to scale.

V(km/h)	A(m)	L(m)	B(m)	D(m)		
50	50	30	35	8		
60	50	40	45	12		
70	75	60	50	15		
80	100	80	60	15		
90	100	105	65	18		
100	125	125	70	18		
110	125	145	75	20		

Where:

- V = Posted Speed Limit
- A = Spacing between signs
- L = Length of Taper
- B = Length of Longitudinal Buffer Space
- D = Spacing between Delineation Devices

\* Refer to chart for minimum distance

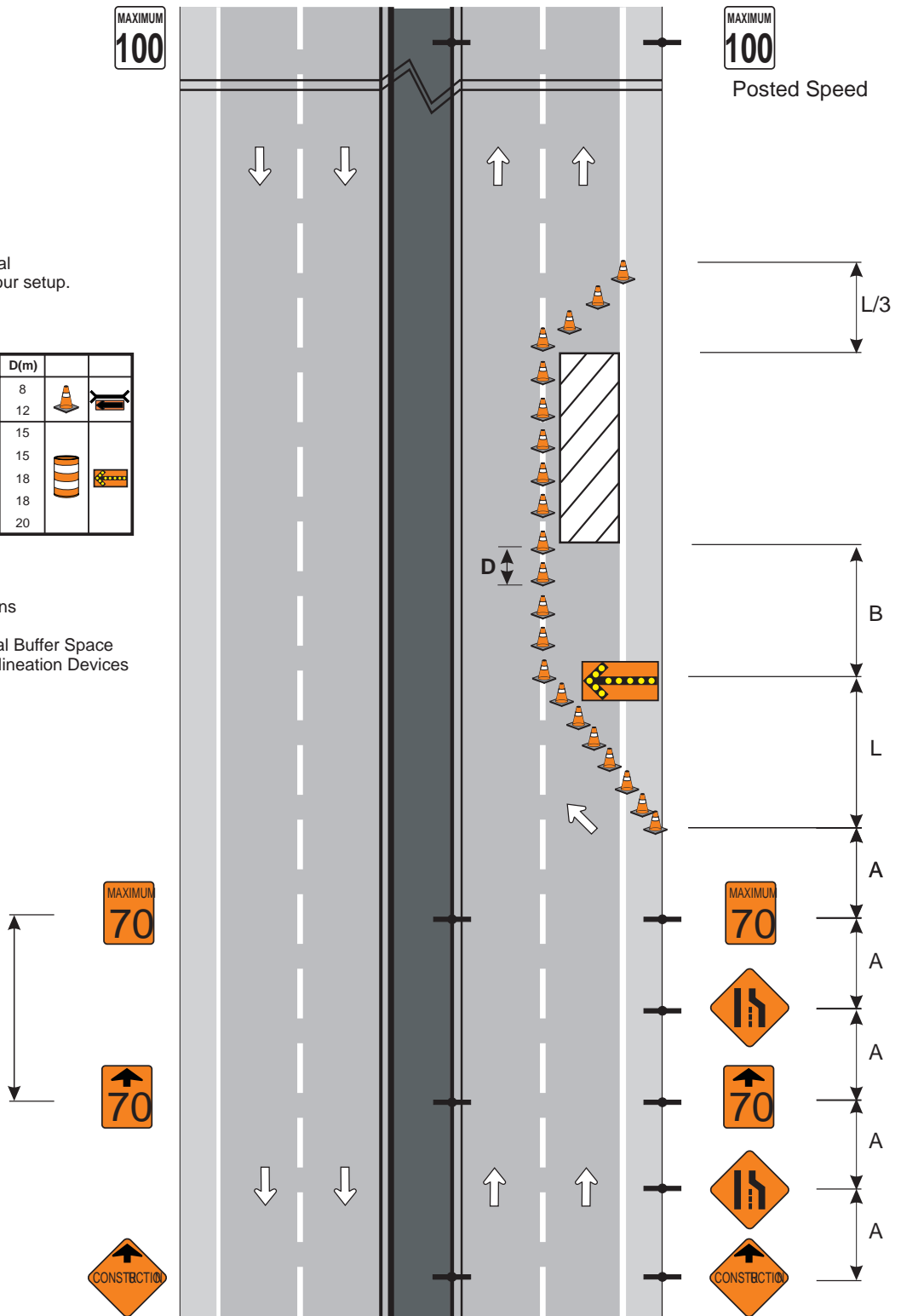

\* Maximum speed ahead sign placement chart can be found in the Appendix.

## 9. Speed reduction with right lane closure

454.1016.013

## **10. Multi-lane closure two right lanes**

### **1. Example shown**

Three-lane – one-way street.

### **2. Conditions**

Two-lane closure.

### **3. Observations**

Each lane must be closed separately and a straight section (tangent) provided between tapers.

Note use of arrow boards.

### **4. Set-up procedure**

Start at bottom of diagram. Set up double-lane closure in order shown. Work towards top of diagram.

Outline worksite with cones.

Commence work.



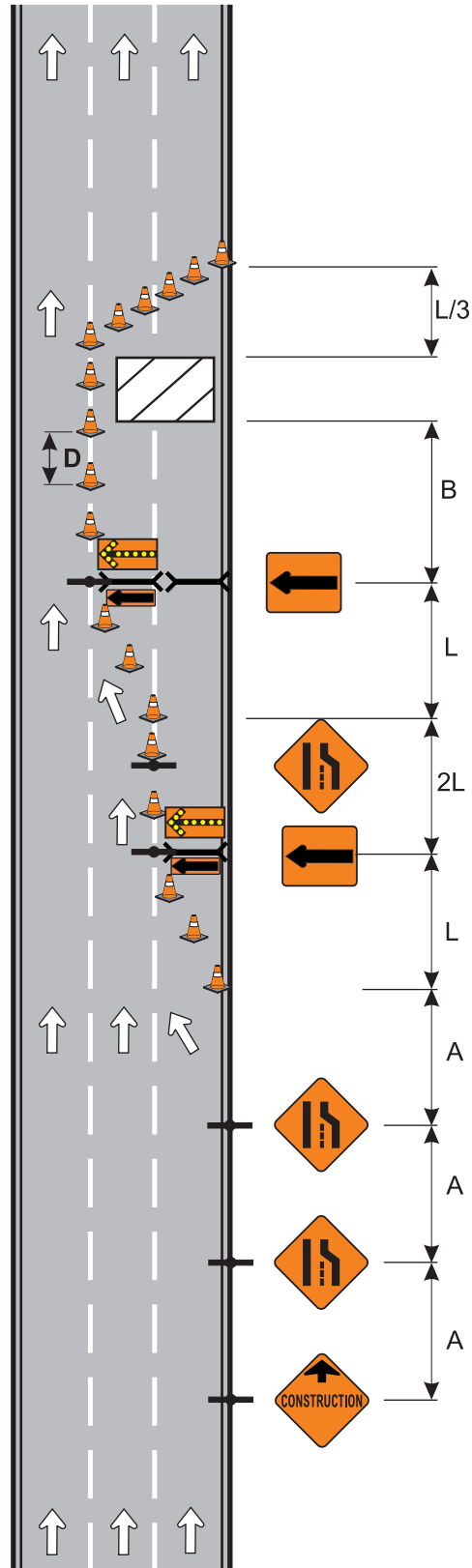

**Note:**

This drawing is a graphical representation of the detour setup. It is **not** drawn to scale.

V(km/h)	A(m)	L(m)	B(m)	D(m)		
50	50	30	35	8		
60	50	40	45	12		
70	75	60	50	15		
80	100	80	60	15		
90	100	105	65	18		
100	125	125	70	18		
110	125	145	75	20		

Where:

V = Posted Speed Limit

A = Spacing between signs

L = Length of Taper

B = Length of Longitudinal Buffer Space

D = Spacing between Delineation Devices

**10. Multi-lane closure  
two right lanes**

454.1016.014

## **11. Multi-lane closure two left lanes**

### **1. Example shown**

Three-lane – one way street.

### **2. Conditions**

Two-lane closure.

### **3. Observations**

Each lane must be closed separately and a straight section (tangent) provided between tapers.

Note use of arrow boards.

### **4. Set-up procedure**

Start at bottom of diagram. Set up double-lane closure in order shown. Work towards top of diagram.

Outline worksite with cones.

Commence work.

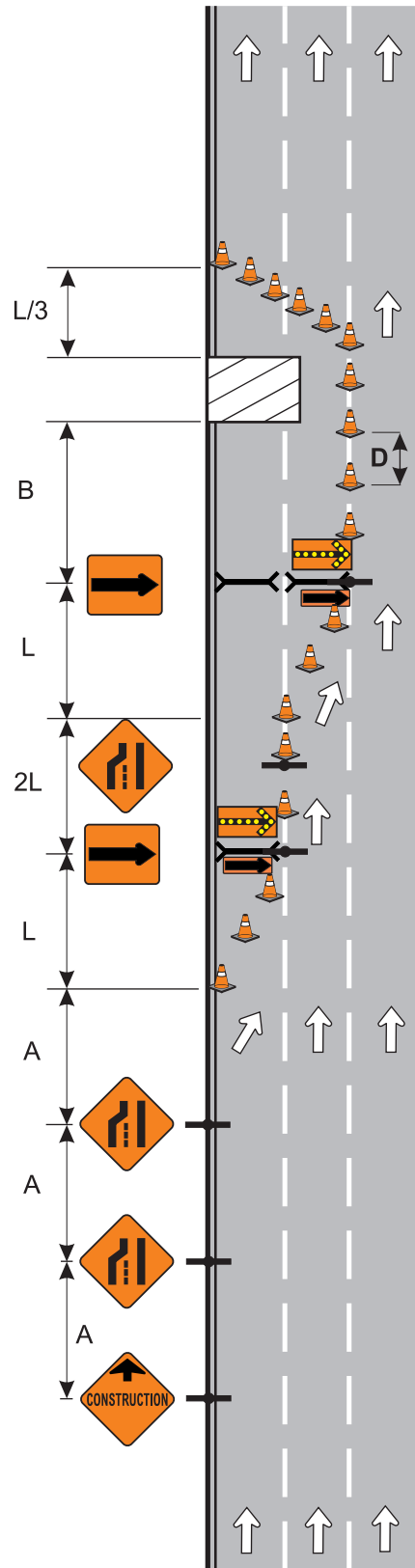

**Note:**

This drawing is a graphical representation of the detour setup. It is **not** drawn to scale.

V(km/h)	A(m)	L(m)	B(m)	D(m)		
50	50	30	35	8		
60	50	40	45	12		
70	75	60	50	15		
80	100	80	60	15		
90	100	105	65	18		
100	125	125	70	18		
110	125	145	75	20		

Where:

- V = Posted Speed Limit
- A = Spacing between signs
- L = Length of Taper
- B = Length of Longitudinal Buffer Space
- D = Spacing between Delineation Devices

## 11. Multi-lane closure two left lanes

454.1016.015

## **12. Multi-lane closure left lane closed in each direction**

### **1. Example shown**

Four-lane – two-way street.

### **2. Conditions**

Set up two single-lane closures, one in each direction.

### **3. Observations**

Use traffic control persons to protect workers during set-up.

Rectangular “text” lane closure signs may be used where conditions do not allow for diamond shaped signs.

### **4. Set-up procedure**

Set up advance warning signs from top and bottom of diagram in order shown.

Set up tapers and outline work area with cones.

Commence work.

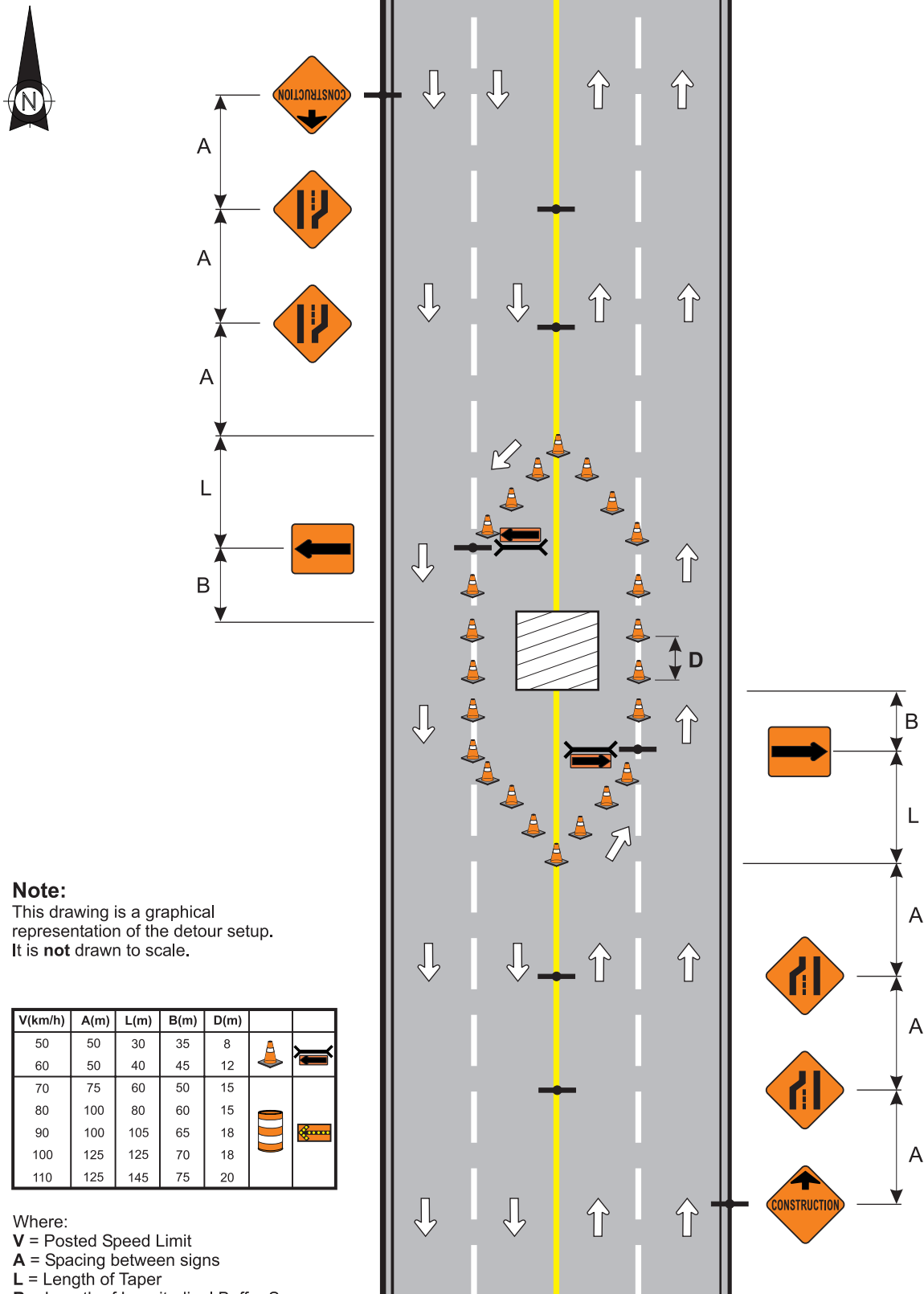

**Note:**  
This drawing is a graphical representation of the detour setup. It is **not** drawn to scale.

V(km/h)	A(m)	L(m)	B(m)	D(m)		
50	50	30	35	8		
60	50	40	45	12		
70	75	60	50	15		
80	100	80	60	15		
90	100	105	65	18		
100	125	125	70	18		
110	125	145	75	20		

Where:  
**V** = Posted Speed Limit  
**A** = Spacing between signs  
**L** = Length of Taper  
**B** = Length of Longitudinal Buffer Space  
**D** = Spacing between Delineation Devices

## 12. Multi-lane closure left lane closed in each direction

454.1016.016

## **13. Centre line crossover two-way traffic**

### **1. Example shown**

Four-lane – two-way street.

### **2. Conditions**

Two-lane closure in one direction.

Single-lane closure in the other direction.

### **3. Observations**

Rectangular “text” lane closure signs may be used where conditions do not allow for diamond shaped signs.

Placement of two-way traffic signs.

### **4. Set-up procedure**

Southbound traffic must be diverted first. Start at top of diagram. Set up single-lane closure, two tapers, barricade, and two-way traffic signs in order shown.

Traffic on right side may now be diverted into oncoming traffic lane. Start at bottom right of diagram.

Set up double-lane closure in order shown. Outline work area with cones.

Commence work.

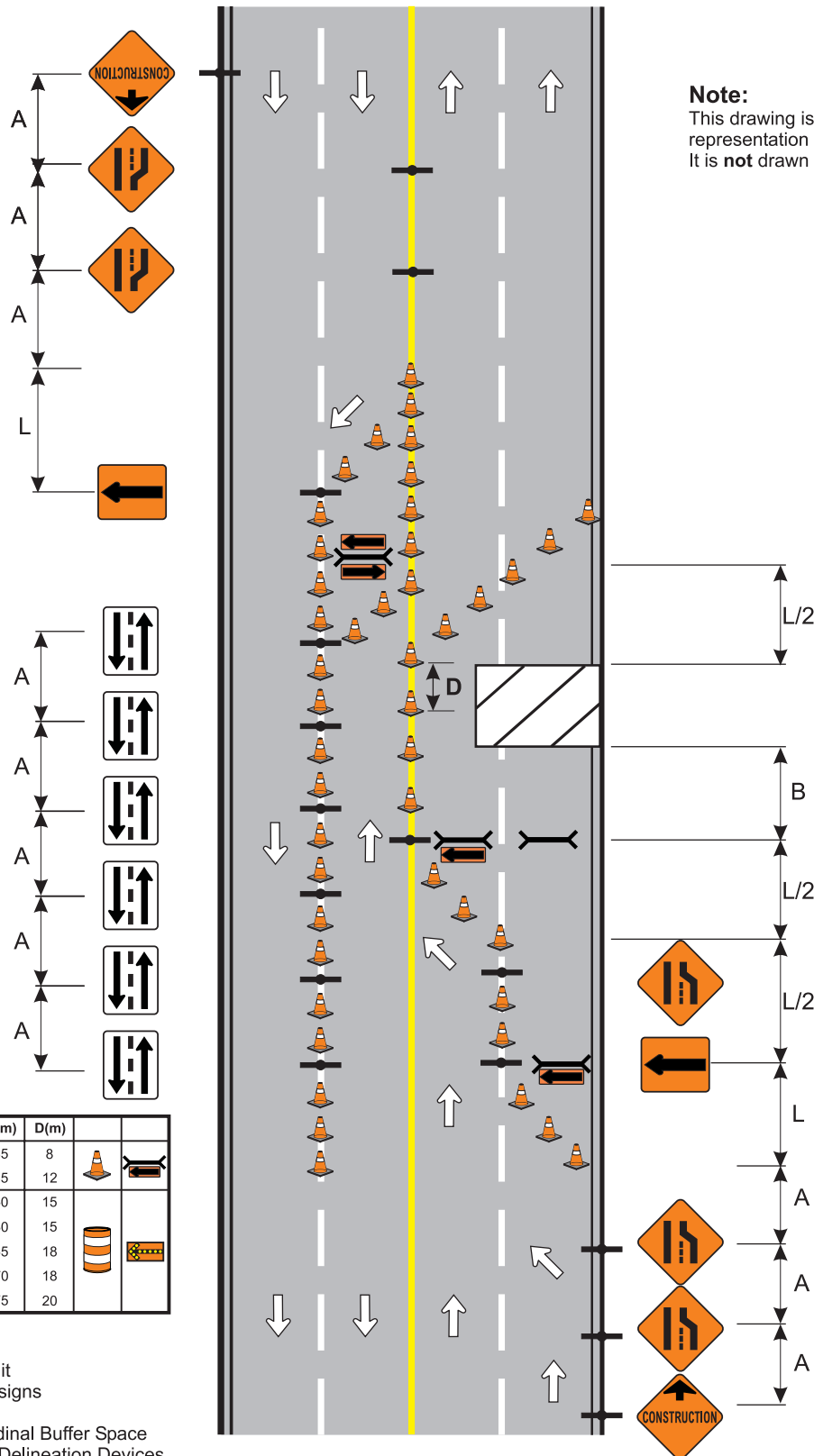

**Note:**  
This drawing is a graphical representation of the detour setup. It is **not** drawn to scale.

V(km/h)	A(m)	L(m)	B(m)	D(m)		
50	50	30	35	8		
60	50	40	45	12		
70	75	60	50	15		
80	100	80	60	15		
90	100	105	65	18		
100	125	125	70	18		
110	125	145	75	20		

Where:  
**V** = Posted Speed Limit  
**A** = Spacing between signs  
**L** = Length of Taper  
**B** = Length of Longitudinal Buffer Space  
**D** = Spacing between Delineation Devices

### 13. Centre line crossover two-way traffic

454.1016.017

## **14. Median crossover two-way traffic**

### **1. Example shown**

Divided two-way, four-lane street.

### **2. Conditions**

One lane of traffic must cross median.

### **3. Observations**

Removal of median may be required or curbs may need to be treated with asphalt to allow crossover.

Note use of arrow board.

Speed reduction may be required.

### **4. Set-up procedure**

Traffic on left side must be diverted first. Start at top of diagram. Set up single-lane closure, two tapers, barricade, and two-way traffic signs in order shown.

Traffic on right side may now be diverted into oncoming traffic lane. Start at bottom right of diagram. Set up double-lane closure in order shown. Outline worksite with cones.

Commence work.



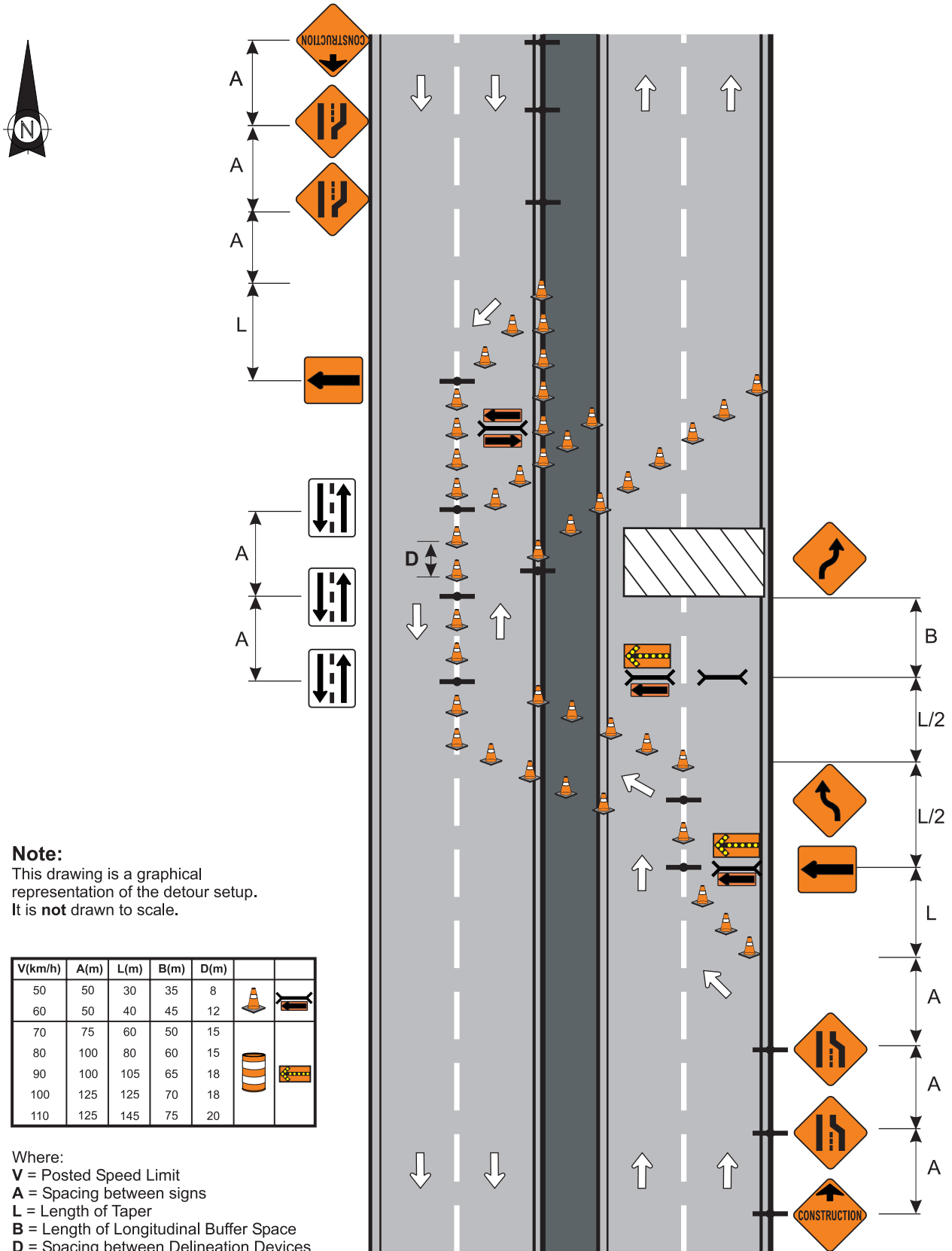

**14. Median crossover  
two-way traffic**

454.1016.018

## **15. Intersection work – Example 1**

### **1. Example shown**

Two-lane – four-legged intersection.

### **2. Conditions**

Require a portion of each lane in each direction.

### **3. Observations**

Use traffic control persons to protect workers during set-up.

### **4. Set-up procedure**

Set up all Construction Ahead signs first.

Outline worksite with cones and Lane Closure Arrow signs.

Commence work.

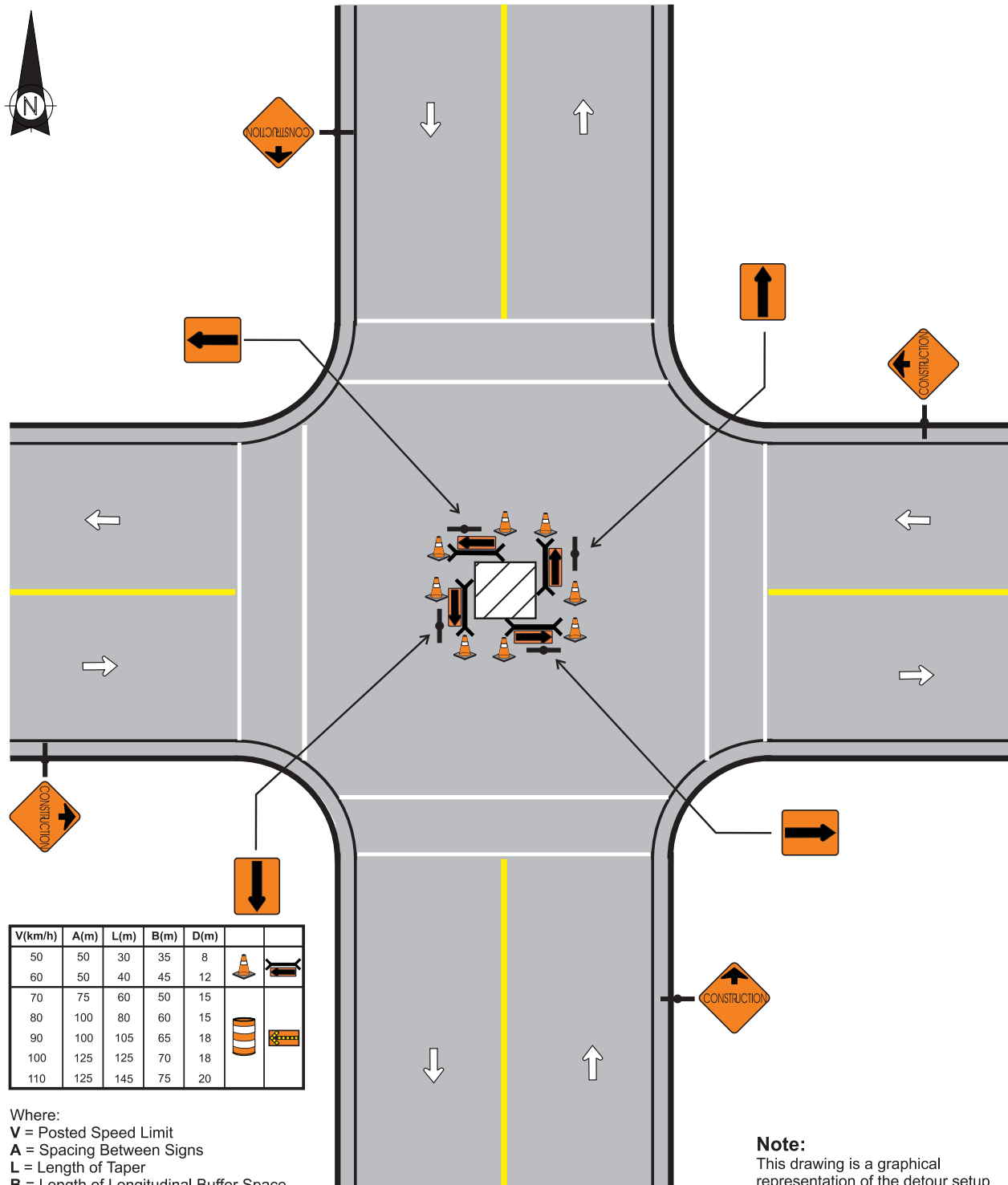

### 15. Intersection work – Example 1

454.1016.019

## **16. Intersection work lane – Example 2**

### **1. Example shown**

Four-legged intersection. Two approaching lanes in all directions.

### **2. Conditions**

Single-lane closure in all directions.

### **3. Observations**

Note lane closures completed before reaching intersections.

### **4. Set-up procedure**

Set up advance warning signs and tapers in each direction. Start from edges of diagram, working towards worksite in order shown.

Post traffic control persons to protect workers.

Outline worksite with cones.

Commence work.

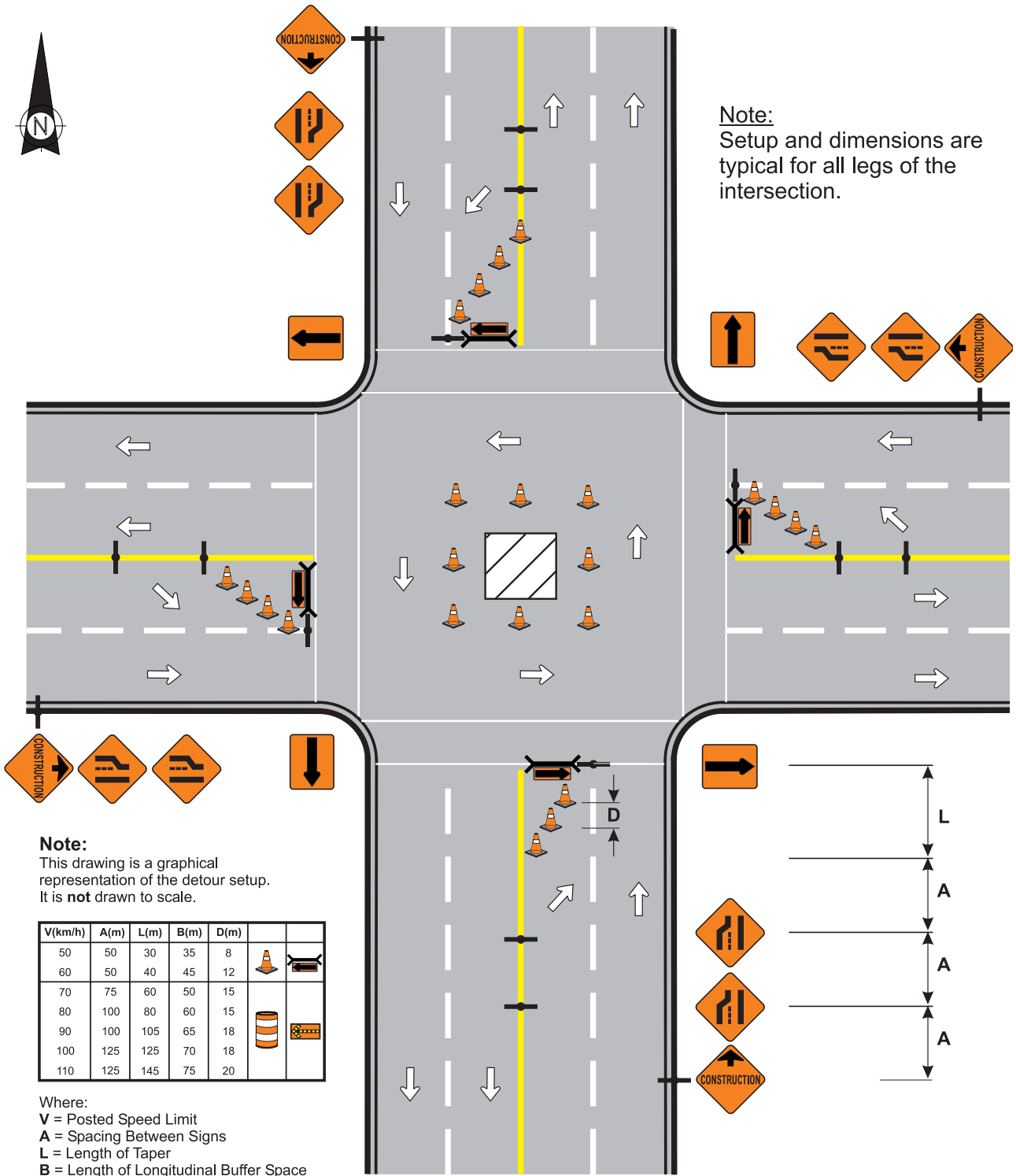

## 16. Intersection work – Example 2

454.1016.020

## **17. Intersection work – Example 3**

### **1. Example shown**

Four-legged intersection. Two approach lanes in all directions.

### **2. Conditions**

Single-lane closure.

Single mandatory right-lane condition.

### **3. Observations**

Protect workers during set-up with traffic control persons.

Mandatory right-lane may require closure depending on traffic volume.

### **4. Set-up procedure**

Set up advance warning signs in order shown from right side of diagram.

Set up advance warning signs and taper in order shown from top of diagram.

Set up Lane Closure Arrow sign.

Outline worksite with cones and barricades.

Commence work.

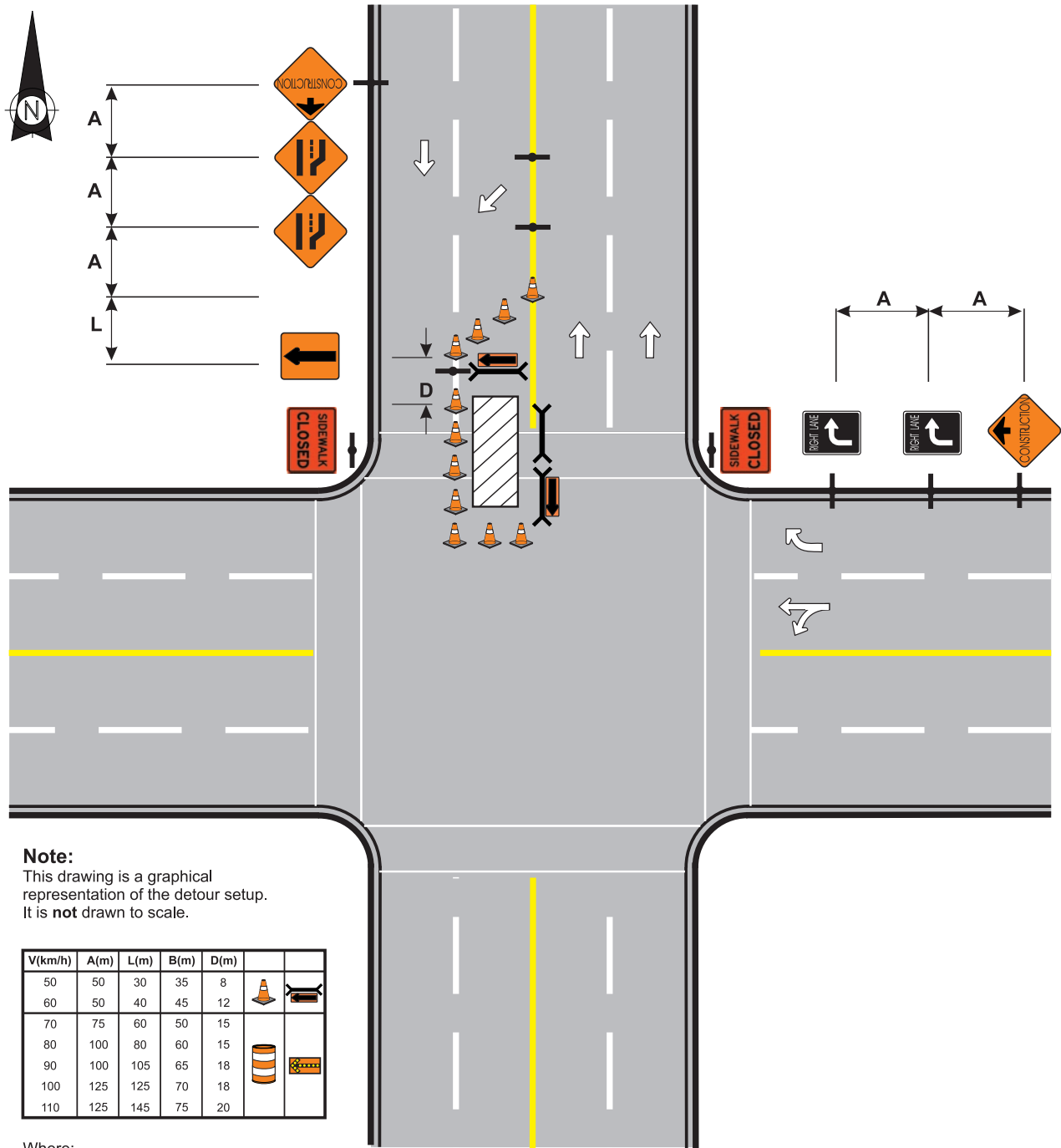

Where:  
**V** = Posted Speed Limit  
**A** = Spacing Between Signs  
**L** = Length of Taper  
**B** = Length of Longitudinal Buffer Space  
**D** = Spacing Between Delineation Devices

### 17. Intersection work – Example 3

454.1016.021

## **18. Intersection work – Example 4**

### **1. Example shown**

Four-legged intersection. Two approach lanes in all directions.

### **2. Conditions**

Single mandatory right-lane condition.

Single mandatory left-lane condition.

### **3. Observations**

Protect workers during set-up with traffic control persons.

Crosswalk closure.

### **4. Set-up procedure**

Set up advance warning signs in order shown at top of diagram.

Set up advance warning signs and taper in order shown left side of diagram.

Post traffic control persons to protect workers.

Outline worksite with cones and barricades.

Commence work.



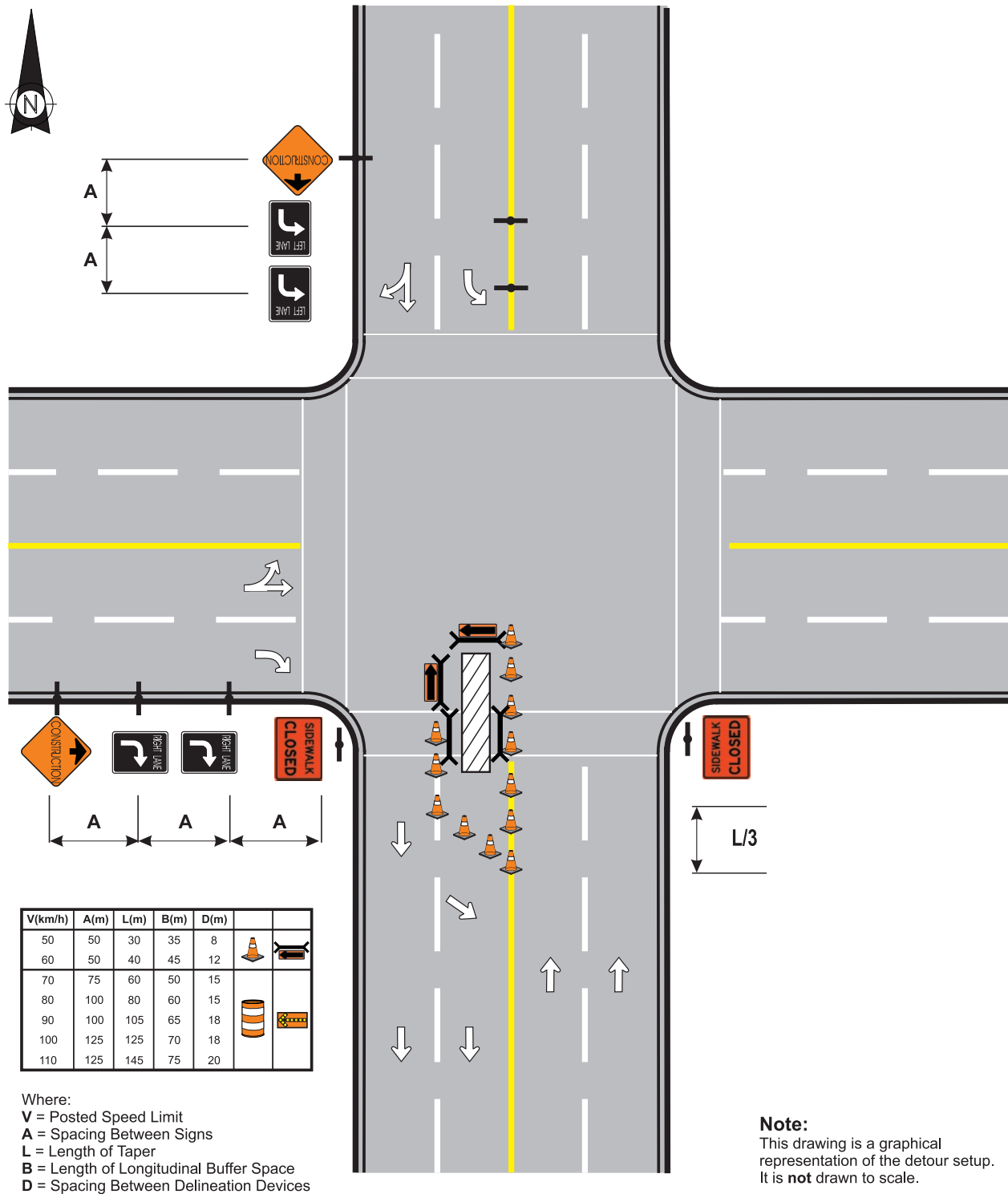

## 18. Intersection work – Example 4

454.1016.022

## **19. Intersection work – Example 5**

### **1. Example shown**

Four-legged intersection. Two approach lanes all directions.

### **2. Conditions**

Two lanes closed in one direction.

Single-lane closure in opposing direction.

### **3. Observations**

Use traffic control persons to protect workers during set-up.

Crosswalk closure.

### **4. Set-up procedure**

Start at the bottom and the right side of the diagram. Set up single-lane closure in order shown (except cones and signs in intersection). Set up mandatory right-lane condition. Install Two-way Traffic signs to top right of diagram.

Start at top of diagram. Set up double-lane closure in order shown.

Post traffic control persons to protect workers during set-up.

Set up cones and signs in intersection.

Commence work.

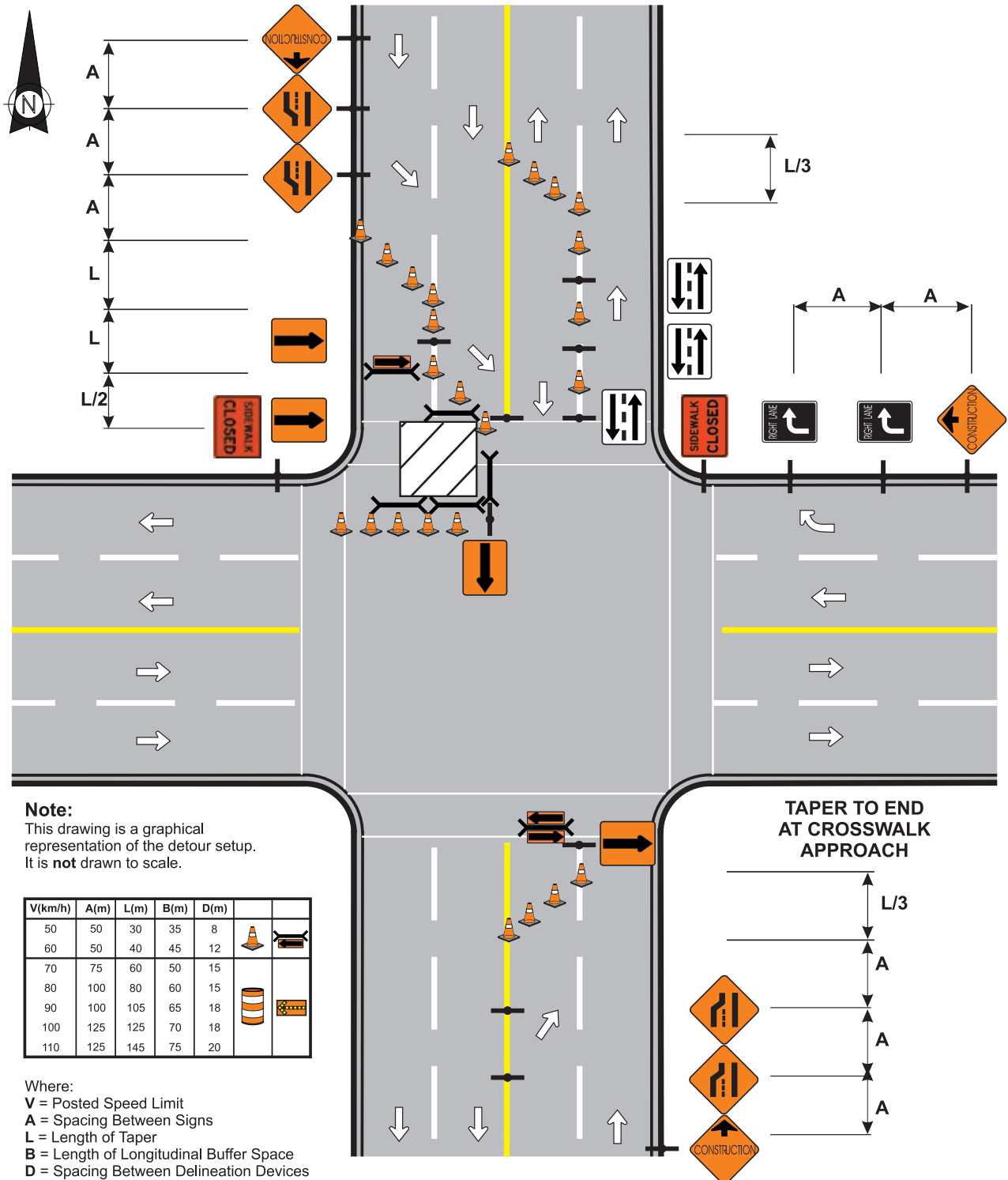

### 19. Intersection work – Example 5

454.1016.023

## **20. Intersection work – Example 6**

### **1. Example shown**

Four-legged intersection. Two approaching lanes in all directions.

### **2. Conditions**

Two-lanes closed in one direction.

Single-lane closed in one direction.

### **3. Observations**

Use traffic control persons to protect workers during set-up.

### **4. Set-up procedure**

Start at the top left of the diagram. Set up advance warning signs in order shown.

Start at the bottom and the left side of the diagram. Set up single-lane closures in order shown (except for cones and signs in intersection).

Post traffic control persons to protect workers during set up.

Set up signs in intersection.

Outline work area with cones.

Commence work.

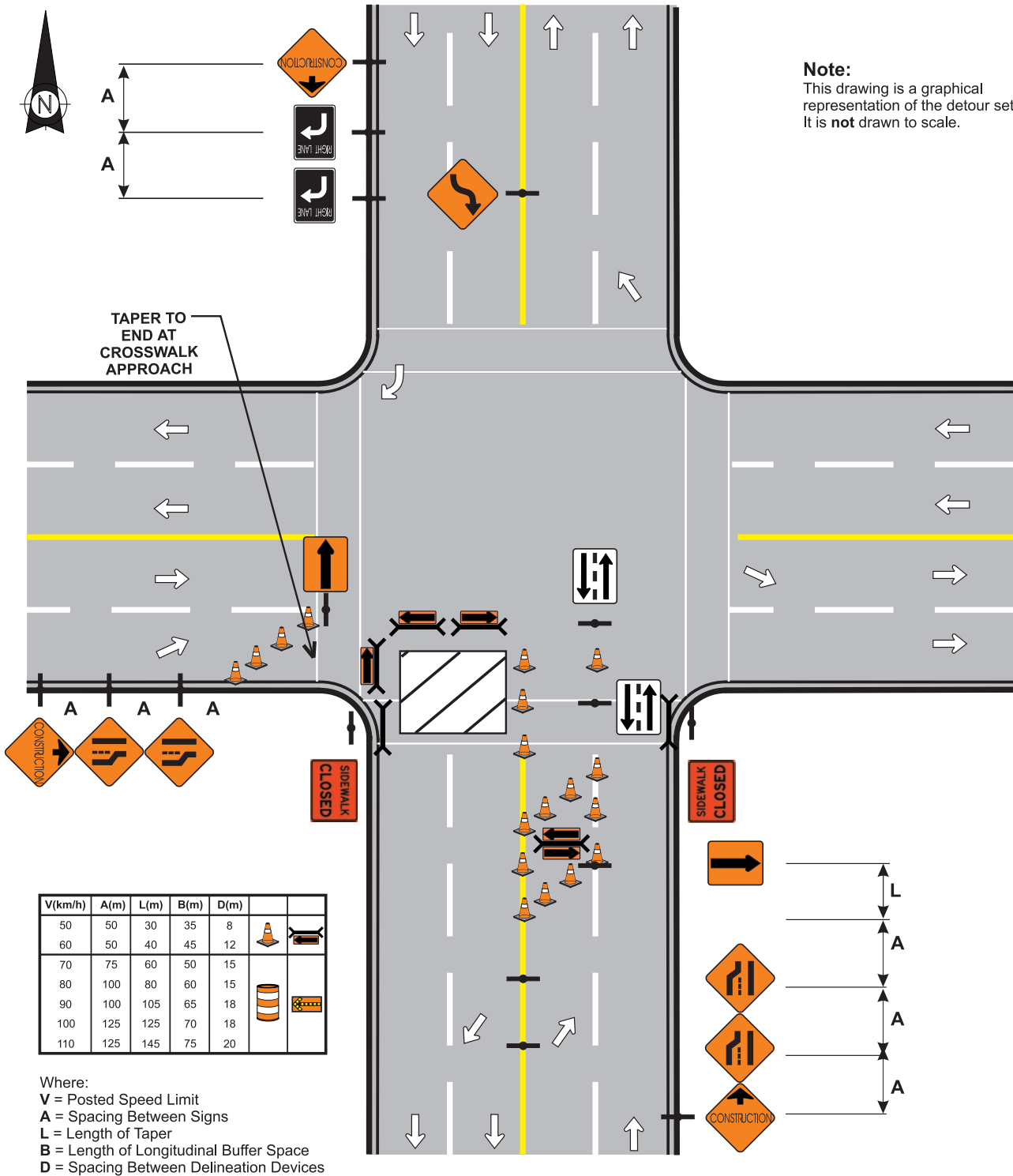

20. Intersection work –  
Example 6

454.1016.024

## **21. Back lane closures**

### **1. Example shown**

Residential back lane.

### **2. Conditions**

One complete closure.

Partial alley closed.

### **3. Observations**

Construction markers and flashers to be used at night and during periods of inactivity.

### **4. Set-up procedure**

As shown.

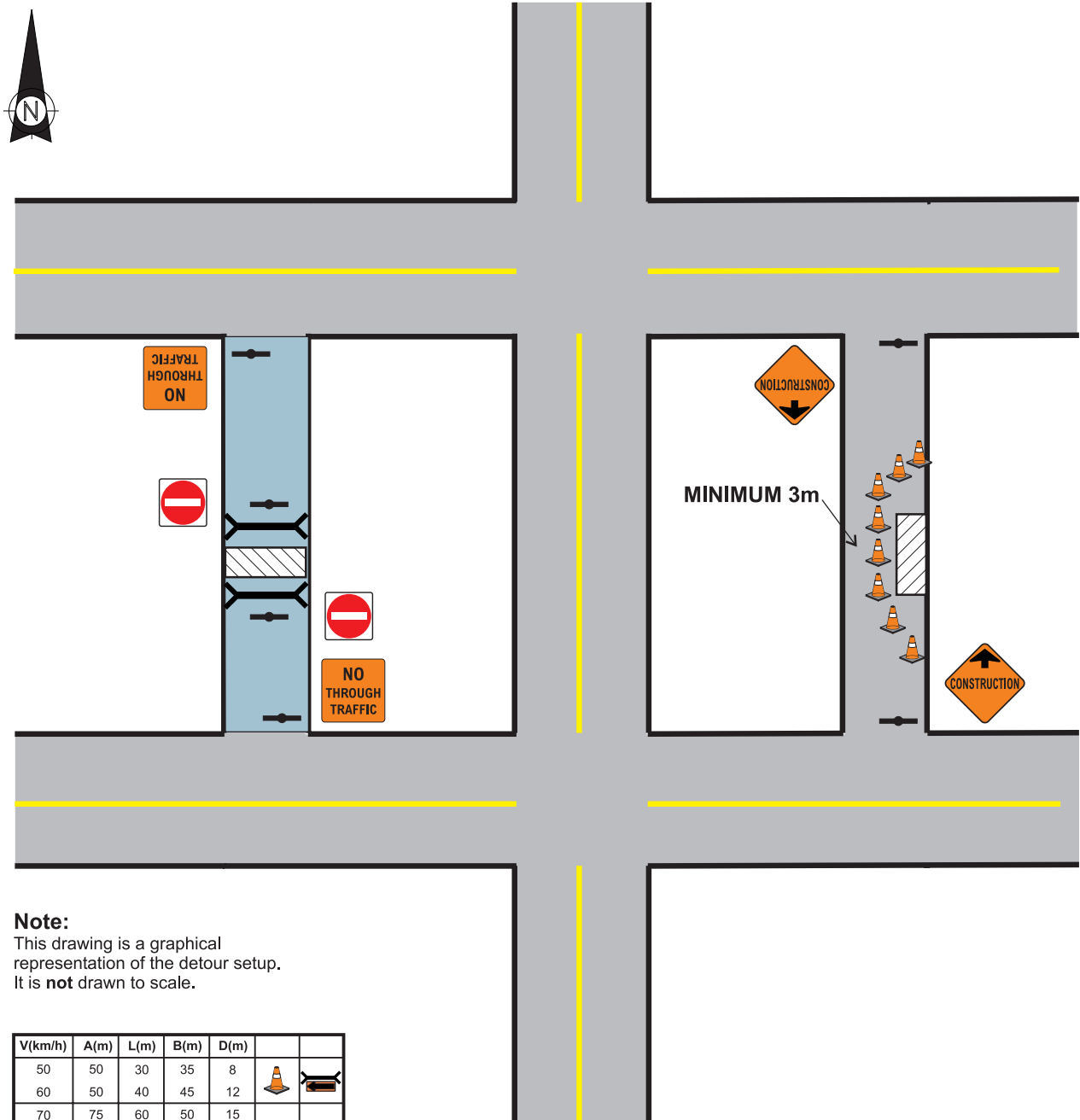

**Note:**  
 This drawing is a graphical representation of the detour setup. It is **not** drawn to scale.

V(km/h)	A(m)	L(m)	B(m)	D(m)		
50	50	30	35	8		
60	50	40	45	12		
70	75	60	50	15		
80	100	80	60	15		
90	100	105	65	18		
100	125	125	70	18		
110	125	145	75	20		

Where:  
**V** = Posted Speed Limit  
**A** = Spacing Between Signs  
**L** = Length of Taper  
**B** = Length of Longitudinal Buffer Space  
**D** = Spacing Between Delineation Devices

## 21. Back lane closures

454.1016.025

## **22. Road closure**

### **1. Example shown**

Two-lane – two-way street.

### **2. Conditions**

Complete road closure.

Detour to adjacent streets.

### **3. Observations**

Note detour signs show direction throughout traffic control zone.

Note closure of adjacent streets.

### **4. Set-up procedure**

Set up detour signs.

Set up all other signs. Close side streets.

Secure work area.

Commence work.



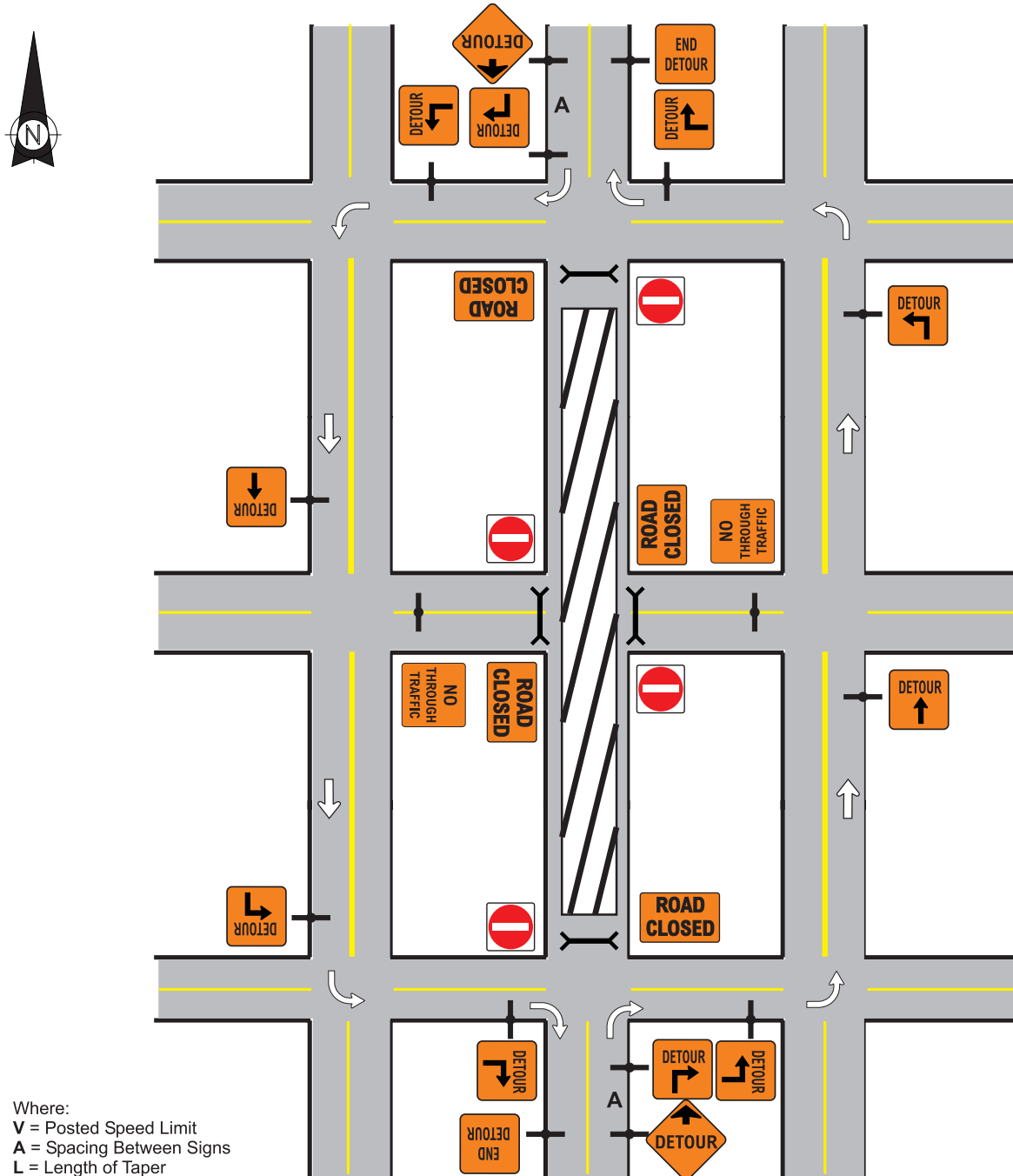

Where:  
**V** = Posted Speed Limit  
**A** = Spacing Between Signs  
**L** = Length of Taper  
**B** = Length of Longitudinal Buffer Space  
**D** = Spacing Between Delineation Devices

V(km/h)	A(m)	L(m)	B(m)	D(m)		
50	50	30	35	8		
60	50	40	45	12		
70	75	60	50	15		
80	100	80	60	15		
90	100	105	65	18		
100	125	125	70	18		
110	125	145	75	20		

**Note:**  
 This drawing is a graphical representation of the detour setup. It is **not** drawn to scale.

## 22. Road closure

## **23. Road diversion two directions**

### **1. Example shown**

Two-lane – two-way street.

### **2. Conditions**

Closure requires diversion.

### **3. Observations**

May require speed reduction.

Note use of delineators around diversion. Construction markers and flashers to be used at night and during periods of inactivity.

Use traffic control persons to protect workers during set-up.

Use of chevrons to be considered depending upon horizontal alignment.

### **4. Set-up procedure**

Build diversion route where necessary to accepted standards.

Set up delineators, barricades and signs on both sides of diversion.

Commence work.

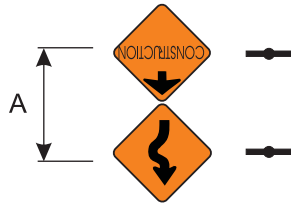

**Note:**  
 Roadmarking or centerline delineation required.

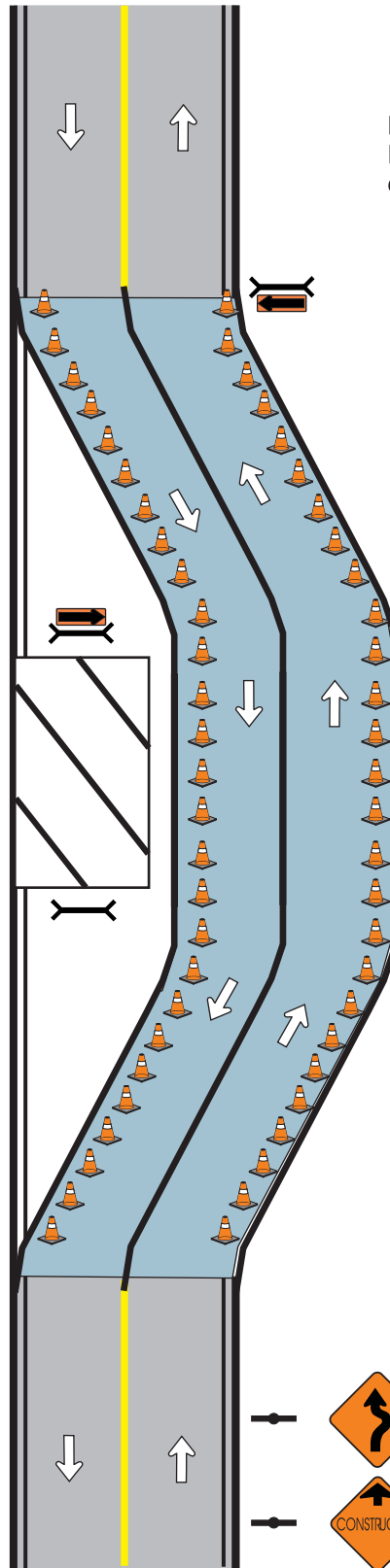

**Note:**  
 This drawing is a graphical representation of the detour setup. It is **not** drawn to scale.

V(km/h)	A(m)	L(m)	B(m)	D(m)		
50	50	30	35	8		
60	50	40	45	12		
70	75	60	50	15		
80	100	80	60	15		
90	100	105	65	18		
100	125	125	70	18		
110	125	145	75	20		

Where:  
**V** = Posted Speed Limit  
**A** = Spacing between signs  
**L** = Length of Taper  
**B** = Length of Longitudinal Buffer Space  
**D** = Spacing between Delineation Devices

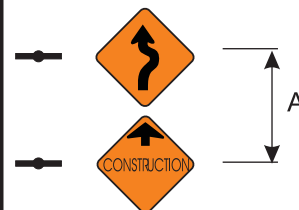

### 23. Road diversion two directions

454.1016.027

## **24. Shoulder detour**

### **1. Example shown**

Four-lane – two-way street with shoulder.

### **2. Conditions**

Two-lane closure requires shoulder detour.

### **3. Observations**

Note speed reduction may be necessary.

Use traffic control persons to protect workers during set-up.

Shoulder must be able to withhold traffic load. Median crossover may be alternative option.

### **4. Set-up procedure**

Set up delineators and barricades along shoulder to mark detour.

Post traffic control persons.





Start at bottom of diagram. Set up double-lane closure in order shown.

Commence work.



**SHOULDER MINIMUM  
LANE WIDTH 3m**

**Note:**  
This drawing is a graphical  
representation of the detour setup.  
It is **not** drawn to scale.

V(km/h)	A(m)	L(m)	B(m)	D(m)		
50	50	30	35	8		
60	50	40	45	12		
70	75	60	50	15		
80	100	80	60	15		
90	100	105	65	18		
100	125	125	70	18		
110	125	145	75	20		

Where:  
**V** = Posted Speed Limit  
**A** = Spacing between signs  
**L** = Length of Taper  
**B** = Length of Longitudinal Buffer Space  
**D** = Spacing between Delineation Devices

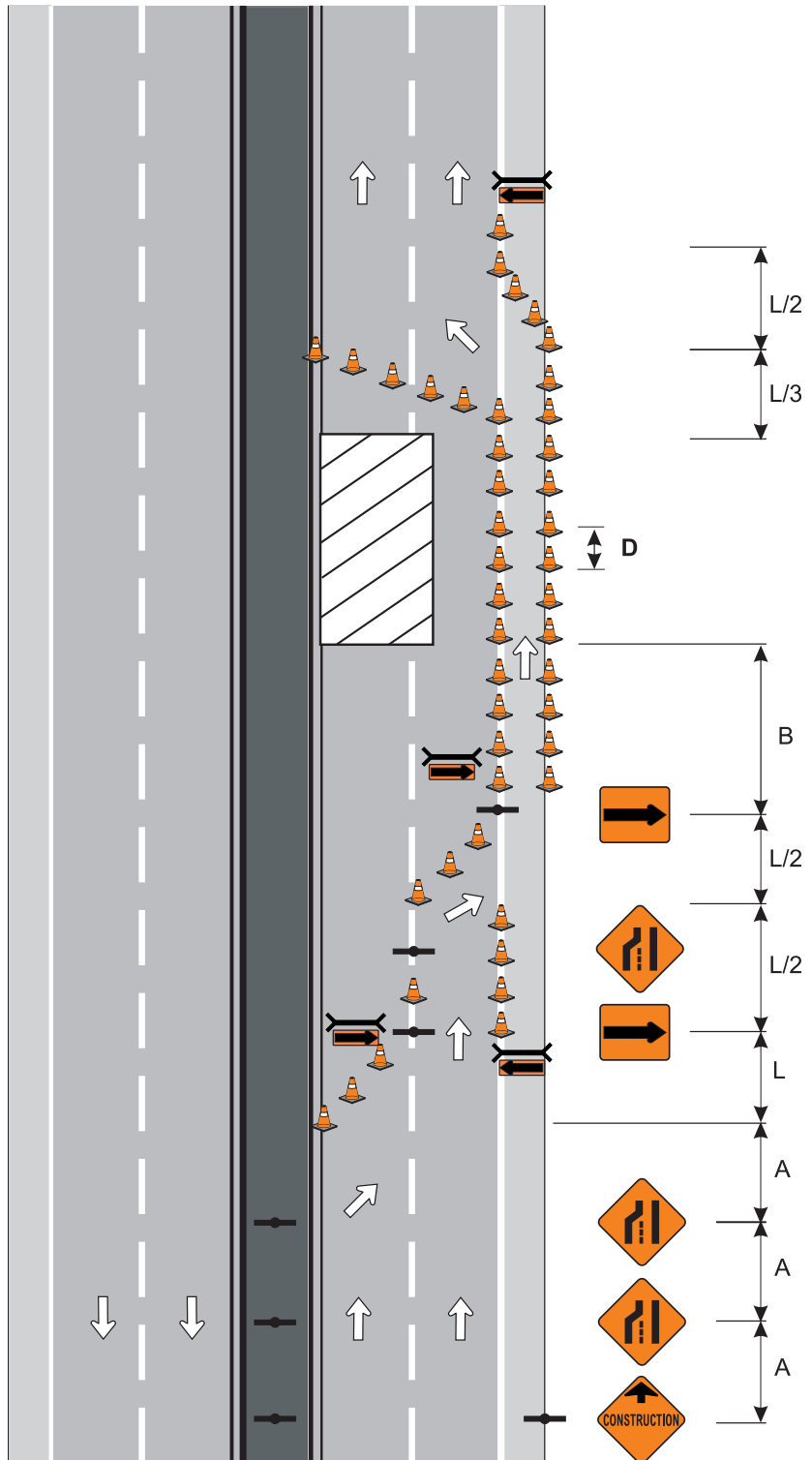

**24. Shoulder detour**

454.1016.028

## **25. Sidewalk closure**

### **1. Example shown**

Pedestrian detour.

### **2. Conditions**

Pedestrians must be physically separated from vehicular traffic and the worksite.

### **3. Observations**

Note barricades to physically separate pedestrians from worksite.

Sidewalk Closed signs direct pedestrians to alternative sidewalk.

### **4. Set-up procedure**

Set up Sidewalk Closed signs and barricade worksite.

Commence work.

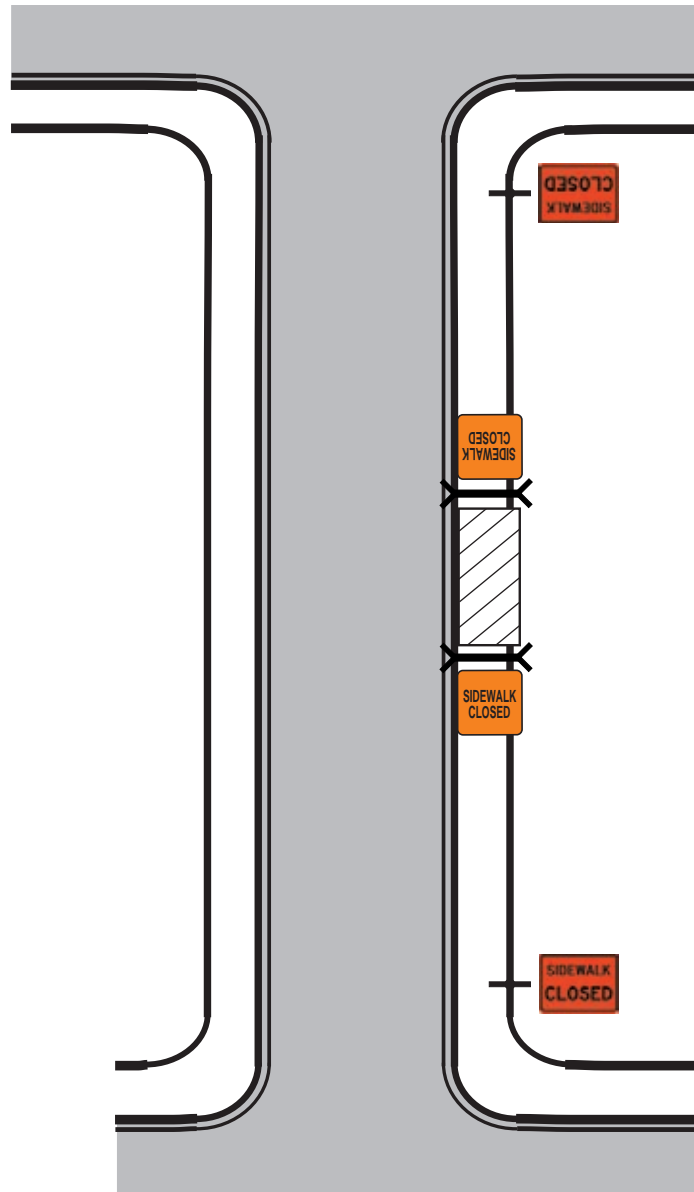

V(km/h)	A(m)	L(m)	B(m)	D(m)		
50	50	30	35	8		
60	50	40	45	12		
70	75	60	50	15		
80	100	80	60	15		
90	100	105	65	18		
100	125	125	70	18		
110	125	145	75	20		

Where:  
**V** = Posted Speed Limit  
**A** = Spacing Between Signs  
**L** = Length of Taper  
**B** = Length of Longitudinal Buffer Space  
**D** = Spacing Between Delineation Devices

**Note:**  
 This drawing is a graphical representation of the detour setup. It is not drawn to scale.

## 25. Sidewalk closure

454.1016.029

## **26. Moving jobs**

### **1. Example shown**

Two-lane – one-way street.

### **2. Conditions**

Mobile/moving jobs are those that are typically done on the move at low speed and may require periodic stopping for only a few minutes duration.

### **3. Observations**

Delineation devices are not required if the operation does not involve stopping.

### **4. Set-up procedure**

Set up signage and devices as required.

Commence work.



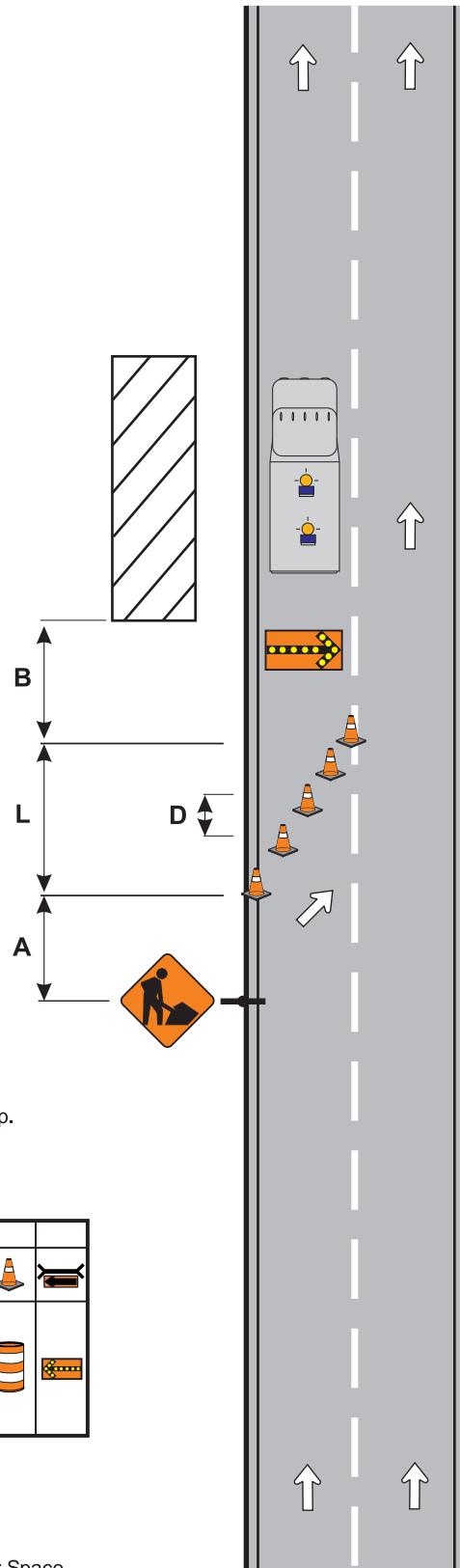

**Note:**

This drawing is a graphical representation of the detour setup. It is **not** drawn to scale.

V(km/h)	A(m)	L(m)	B(m)	D(m)		
50	50	30	35	8		
60	50	40	45	12		
70	75	60	50	15		
80	100	80	60	15		
90	100	105	65	18		
100	125	125	70	18		
110	125	145	75	20		

Where:

**V** = Posted Speed Limit

**A** = Spacing Between Signs

**L** = Length of Taper

**B** = Length of Longitudinal Buffer Space

**D** = Spacing Between Delineation Devices

**26. Moving jobs**

454.1016.030

## **27. Road bridging**

### **1. Example shown**

Three-lane – one-way street.

### **2. Conditions**

Bridging to be installed for rush hour traffic and during periods of inactivity.

### **3. Observations**

Note bump sign.

Refer to Chapter 3 on bridging for necessary requirements.



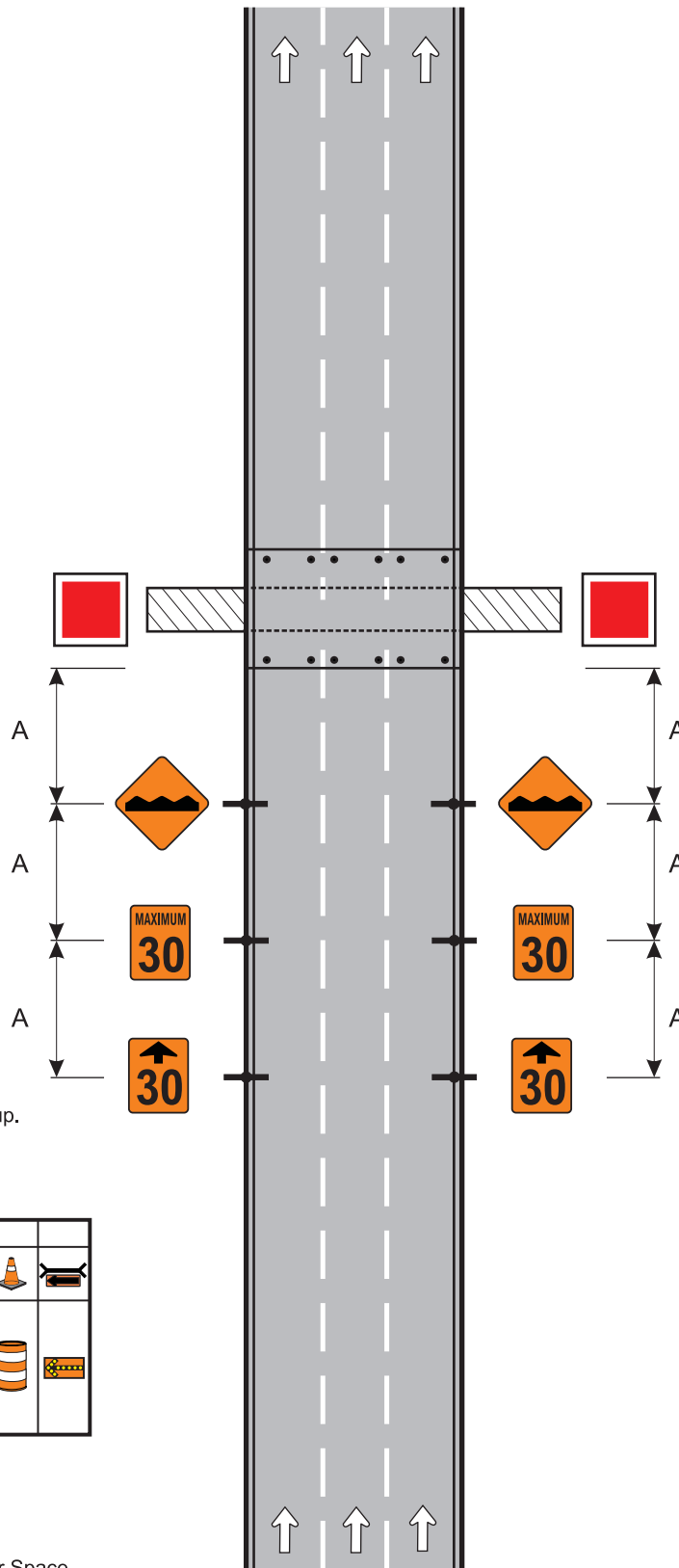

Note temporary hazard markers.

### **4. Set-up procedure**

All signs to be in place before vehicle traffic allowed on bridging.



**Note:**  
 This drawing is a graphical representation of the detour setup. It is **not** drawn to scale.

V(km/h)	A(m)	L(m)	B(m)	D(m)		
50	50	30	35	8		
60	50	40	45	12		
70	75	60	50	15		
80	100	80	60	15		
90	100	105	65	18		
100	125	125	70	18		
110	125	145	75	20		

Where:  
**V** = Posted Speed Limit  
**A** = Spacing between signs  
**L** = Length of Taper  
**B** = Length of Longitudinal Buffer Space  
**D** = Spacing between Delineation Devices

## 27. Road bridging

454.1016.031

## **28. Speed fines double**

### **1. Example shown**

Speed Fines Double set up on divided two-way, four lane street.

### **2. Conditions**

Closure of right lane with Speed Fines Double signage.

### **3. Observations**

Note two Right Lane Ends and use of arrow board signs to allow more reaction time for motorists to change lanes.

Note Construction Ahead, 70 Ahead and Maximum 70 signs are used on both sides of roadway.

Note Speed Fines Double signage begins and ends with associated speed signs.

### **4. Set-up procedure**















Start at bottom of diagram.

Set up advance warning signs in order shown.

Set up taper and outline work site with cones.

Commence work.

**Note:**  
This drawing is a graphical representation of the detour setup. It is **not** drawn to scale.

V(km/h)	A(m)	L(m)	B(m)	D(m)		
50	50	30	35	8		
60	50	40	45	12		
70	75	60	50	15		
80	100	80	60	15		
90	100	105	65	18		
100	125	125	70	18		
110	125	145	75	20		

Where:  
**V** = Posted Speed Limit  
**A** = Spacing between signs  
**L** = Length of Taper  
**B** = Length of Longitudinal Buffer Space  
**D** = Spacing between Delineation Devices

Refer to chart for minimum distance

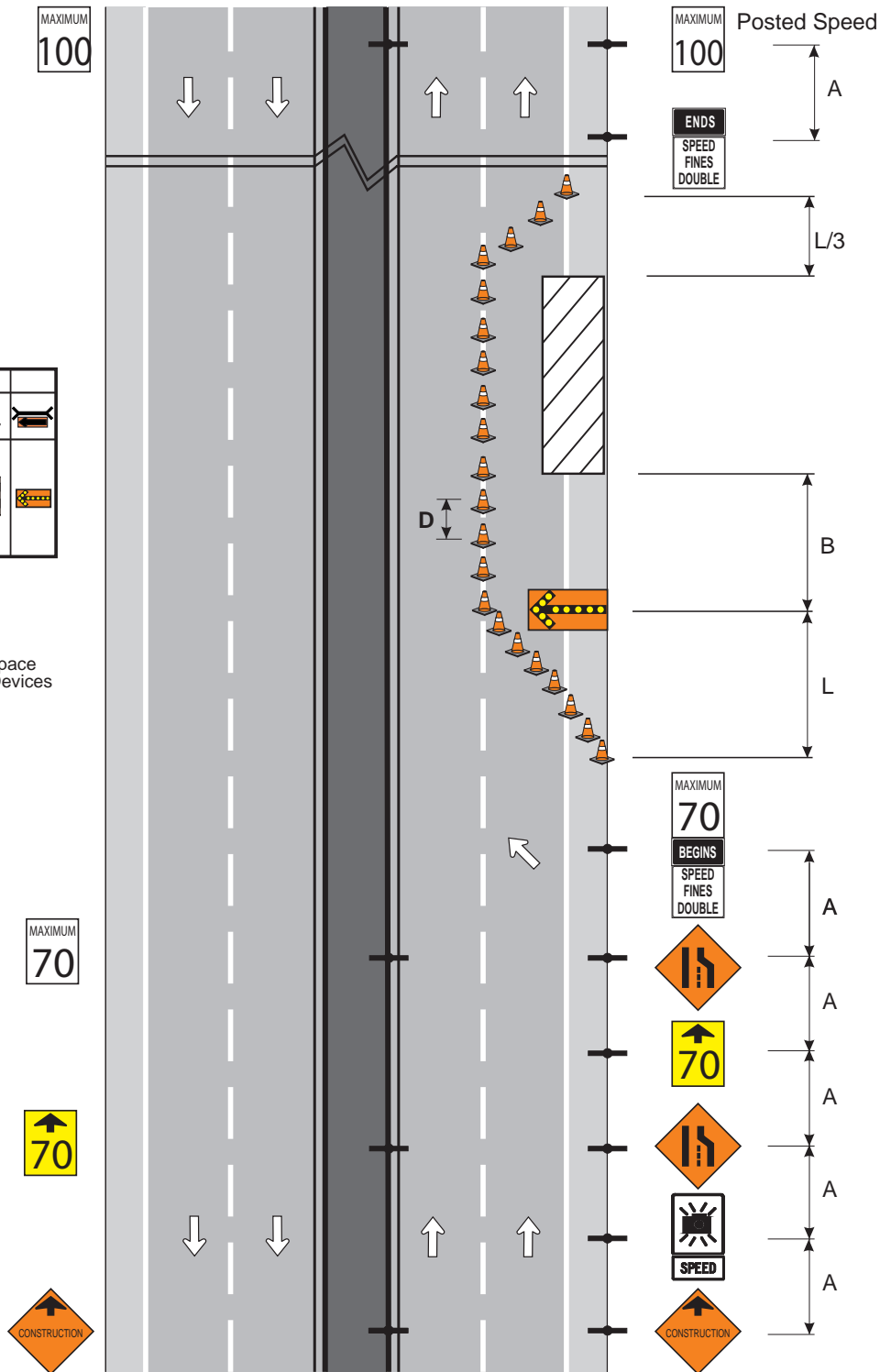

## 28. Speed fines double

454.1016.032



## Chapter 6 – Incident/emergency procedures

### Guidelines for The City of Calgary personnel

This section is a guide for any employee's response to an emergency. Examples of emergency situations are:

1. Collisions.
2. Roadway obstructions (debris on road).
3. Water ponding on roadway.
4. Dangerous goods/hazardous materials incidents.

### Collisions

In all cases:

1. Pull over to shoulder and assess the situation.
2. Notify police immediately by calling 101 Dispatch at 3-1-1. Give details of exact location, injuries (if any), and number of traffic lanes affected.
3. Protect the collision site.
  - Approach collision site with arrow board or beacon and/or four-way flashers activated.
  - Slowly come to a stop 40 m in advance of the collision site. Set emergency brake.
  - Leave the vehicle immediately, wearing all personal safety equipment.
  - Assist at collision scene as much as possible, but do not put yourself knowingly at risk in traffic.
  - If the collision involves injuries, leave the scene undisturbed.
  - Do not move injured people off the road unless they are at risk from traffic or fire.
  - When emergency personnel arrive, follow their instructions.

### Roadway obstructions (i.e. debris)

In all cases:

1. Pull over onto the shoulder nearest to the obstruction.
2. Notify Engineering Channel 1 – 101 Dispatch (3-1-1) immediately for emergency lane closure.
3. Give details of exact location, type and size of obstruction/debris, and how many lanes are affected.
4. Do not attempt to remove obstruction/debris. Qualified personnel will arrive to remove it.
5. Do not use your vehicle to close off lanes of traffic.

6. If there is obvious danger to the public, remain on site. Warn oncoming traffic in advance of the obstruction, from the shoulder of the roadway nearest to the obstruction.
7. Wear all personal safety equipment.

### **Water ponding on roadway**

In all cases:

1. Pull over onto the shoulder nearest pool.
2. Notify Engineering Channel 1 101 Dispatch (3-1-1) immediately for emergency lane closure and to notify Water Services.
3. Give details of exact location and how many lanes are affected.
4. Do not use your vehicle to close lanes of traffic.
5. If there is an obvious danger to the public, remain on site.
6. Warn traffic in advance of the pool from the shoulder nearest the pool.
7. Wear all personal safety equipment.

### **Potential dangerous goods/hazardous materials incidents**

In all cases:

1. Approach the scene from uphill and upwind when hazardous materials are suspected.
2. Identify placards, signage or container shape, from a distance, prior to close proximity approach.
3. Avoid direct contact with the product and its vapours.
4. Once involved products are identified, notify the fire department (Hazardous Materials Response Team) and police immediately at 911 or through Engineering Channel 1 – 101 Dispatch (3-1-1). Give the UN number of product, exact location, nature of the incident (if possible), and number of lanes affected.
5. Use your vehicle to close traffic lanes from a safe distance. The product involved and research information provided by the dispatcher or 911 operator will determine this distance.
6. Warn traffic in advance, from the shoulder nearest the site. Activate arrow board or beacon and/or four-way flashers.
7. Leave the vehicle immediately, wearing all personal safety equipment and find a safe place to wait, away from the contaminated area.
8. When emergency personnel arrive, follow their instructions.

Note: certain chemicals are extremely hazardous. Always stay upwind from the incident site and never put yourself or others at risk.



## **Procedures for trained personnel assigned to emergency incidents**

A foreman shall be assigned to each emergency situation requiring longer than 15 minutes to restore to normal conditions.

The foreman must report to the incident commander on arrival at the incident for briefing of existing emergency traffic management and future objectives. All agencies in attendance must be aware that the contractor is on scene and included in developing a plan for the takeover of traffic accommodation.

The assigned foreman will remain on site at all times until normal conditions are resumed, or a full traffic set-up is in place.

It shall be the responsibility of the assigned foreman to observe traffic flow around the work area. If a hazard becomes apparent, the foreman and supervisor must take appropriate action to maintain safe working conditions.

This may include removing workers and/or equipment from the road until a full traffic set-up is in place.

### **Emergency response set-up**

- The number of arrow boards dispatched is determined by the number of lanes to be closed plus one arrow board for advance warning.
- A full traffic set-up shall be requested immediately if normal conditions can not be resumed in one hour. Length of time involved must be determined within the first 15 minutes at the site.
- This set-up will be maintained or upgraded until a full traffic set-up is in place, or normal conditions are resumed.

### **Additional protective measures**

For emergency set-ups of one hour or more, or as traffic conditions warrant, it is expected that additional measures be taken. These measures increase visibility and safety at the worksite.

These measures are over and above the accepted minimum for emergency set-ups. Any or all are acceptable.

1. Flag traffic right or left from the shoulder in advance of the shoulder arrow board. This is most effective when two or more lanes have been closed, or when the worksite is located around a curve. Use approved safety apparel and traffic control paddles.
2. If it can be done safely, cones may be set-up in the traffic control zone. One or both of the following is acceptable:
  - Set up cones along the skip line between each arrow board. This will prevent motorists from changing lanes in the wrong direction.
  - Set up cones across closed traffic lanes beside each arrow board. This will identify closed traffic lanes for the motorist.
3. Although a full traffic set-up may not be necessary, Traffic Operations Division can supply traffic control devices for a partial set-up. Call the Division at 3-1-1 (office hours) or Engineering Channel 1 – 101 Dispatch, 3-1-1 (after hours).

4. Have the traffic control zone sanded in slippery conditions. Call Engineering Channel 1 – 101 Dispatch 3-1-1.
5. Trailer-mounted message boards and arrow boards are available by calling Traffic Field Operations Division. Call 3-1-1 (office hours) or Dispatch 101 – 3-1-1 (after hours).
6. Trailer mounted arrow boards are available from Streets Division. Call 101 Dispatch (268-1155) for details.
7. Carmacks or other independent contractors should be included as a resource.

Calgary Police Service can supply units to close traffic lanes or increase job site visibility. Call 101 Dispatch at 3-1-1. 101 Dispatch will contact CPS.

Note: This measure shall only be taken when all other measures fail to provide safe working conditions.

## Glossary

### **Acceleration lane**

A lane that enables vehicle to increase speed when merging with through traffic.

### **Activity area**

The activity area is the section of roadway where the work activity takes place. It is comprised of the work space and the traffic space, and may contain one or more buffer spaces.

### **Advance warning area**

In the advance warning area, drivers are informed of what to expect in the downstream work zone or incident area.

### **Advance warning signs**

Signs that give motorists and pedestrians advance notice of disruptions in normal traffic flow. These signs indicate the nature of traffic disruption, and the required action on the part of motorists and pedestrians.

### **Agency or contractor**

Any City department, private contractor, or public utility agency that has permission and necessary permits to undertake work on, or adjacent to, City of Calgary public roadways.

### **Arrow displays or arrow boards**

Flashing arrow displays/boards are traffic control devices which can provide an illuminated flashing display of a left arrow, a right arrow, or combination of the left-right arrow, sequencing arrow modes, or a bar which inform the driver to either change lanes or proceed with caution. An arrow display/board shall be used in combination with the appropriate signs, barricades or other traffic control devices.

### **Arterial**

A road primarily for through-traffic.

### **Auxiliary lane**

A lane in addition to, and placed adjacent to a through-lane.

### **Average daily traffic (ADT)**

The total volume of traffic passing a designated point, in both directions, in one day.

### **Breakaway device**

A design feature that allows a device such as a sign to yield or separate upon impact.

### **Bridging**

A method to enable vehicles to pass over narrow and shallow trenches by fastening sheet steel to the roadway to form a bridge. It is used at peak congestion times to accommodate traffic when backfilling is not practical.

### **Buffer space**

The buffer space is the area that separates traffic flow from the work activity or a potentially hazardous area and provides recovery space for an errant vehicle. Neither work activity nor storage of equipment, vehicles, or material should occur in this space. Buffer spaces may be positioned longitudinally and laterally, with respect to the direction of traffic flow.

### **Buffer vehicle**

A vehicle positioned in a stationary work zone or in a mobile work operation, to provide protection for workers against errant vehicles (also referred to as a shadow vehicle). These vehicles should be equipped with an arrow display/board and a truck-mounted attenuator.

### **Collector road**

A road in which access and traffic movement have similar importance.

### **Decision sight distance (DSD)**

The distance for a driver to detect a layout, recognize it, and maneuver safely.

### **Delineation devices (or tapering devices)**

Devices used to form curves, lines, or boundaries that indicate the alignment of the roadway and outline the required vehicle path through the temporary traffic control zone. They include, but are not limited to cones, drums, tubular markers, barricades and chevrons, and shall be used in combination with, or be supplemental to other traffic control devices.

### **Design speed**

A speed selected for purposes of road design.

### **Detour**

A detour is a temporary route where a driver or pedestrian is required to depart completely from the normal route to bypass the activity area.

### **Diversion**

Traffic is directed onto a temporary roadway or alignment placed in or next to the ROW.

### **Downstream**

The area past the TTC work zone in the direction of traffic flow.

### **Expressway**

A divided arterial roadway for through traffic with full or partial control of access and with some interchanges. Posted speeds are typically less than or equal to 80 km/h.

### **Freeway**

A multi-lane, divided highway with a minimum of two lanes for the exclusive use of traffic in each direction, and full control of access without traffic interruption. Posted speeds are typically greater than or equal to 90 km/h.

### **Gore area**

An area of pavement delineated by paint lines or delineation devices, between the edge line of the through road and the entry or exit ramp.

**Hoarding**

A form of fencing or barrier or combination of these, designed to separate pedestrians and/or motorists from a construction site.

**Impact attenuators**

A device (also known as crash cushions) that prevents an errant vehicle from impacting a fixed object by safe, controlled deceleration. Impact attenuators in temporary traffic control zones protect the motorists from the exposed ends of barriers, fixed objects and other hazards.

**Intersection sight distance (ISD)**

The line of sight between intersecting roadways.

**Lateral buffer space**

A lateral buffer space is used to separate the traffic space from the work space, or a potentially hazardous area, such as an excavation or pavement drop-off. The width of the lateral buffer space should be determined by engineering judgement.

**Longitudinal barrier**

A barrier whose primary function is to prevent a collision and redirect an errant vehicle.

**Longitudinal buffer space**

The longitudinal buffer space is placed in the initial portion of a closed lane in advance of the work space.

**May**

A permissive condition.

**Median**

A reserve, including shoulders between through lanes.

**Variable message boards (portable changeable message signs)**

Are traffic control devices with the flexibility to display a variety of messages.

**Regulatory sign**

Signs used to identify a traffic regulation that is applicable at a given time or place on a road, and to identify the legal requirements.

**Rigid Barrier**

A form of longitudinal barrier that is intended to redirect an errant vehicle with minimum deflection. It usually consists of a continuous concrete mass (i.e. a concrete, safety-shaped barrier such as the New Jersey barrier).

**Semi-rigid barrier**

A form of longitudinal barrier intended to redirect an errant vehicle by rail tension and bending. Examples are the blocked W-Beam or Thrie-Beam.

**Shall**

A mandatory requirement.

## **Should**

An advisory requirement.

## **Stopping distance**

The distance traveled by a vehicle from the instant the driver decides to stop until stopped.

## **Stopping sight distance (SSD)**

The distance between vehicle and object for which the driver decides to stop, from the instant the object comes in view. This includes the distance travelled during perception and reaction times plus the braking distance.

## **Tangent**

A straight section of roadway. In TTC set-ups it is the distance between the end of one taper and the beginning of the next.

## **Taper**

The gradual narrowing of a lane using channelization devices, intended to safely guide drivers into the adjacent lane. The following identifies various types of tapers used in temporary traffic control.

- **Merging taper**

A merging taper requires the drivers to merge with an adjacent lane of traffic. The taper should be long enough to enable drivers to adjust their speeds and merge into a single lane before the end of the transition. A merging taper requires a full lane shift.

- **One-lane, two-way (traffic) taper**

The one-lane, two-way traffic taper is used where the portion of road is used alternately by traffic in each direction. These are typically used when traffic is controlled by traffic control persons.

- **Shifting taper**

A shifting taper is used where a lateral shift (not a full lane merge/diverge) is required and includes a parallel lane shift (lane encroachment) or a shoulder shift taper (shoulder encroachment).

- **Shoulder taper**

A shoulder taper can be used on roadways with improved shoulders that may be mistaken for driving lanes.

- **Termination (downstream) taper**

The downstream taper may be useful in termination areas to provide a visual clue to the driver that access is available to the original lane path that was closed.

## **Temporary traffic control (TTC)**

Provides for the movement of vehicles, bicycles and pedestrian traffic and public transit, when the normal function of a roadway is suspended.

## **Termination area**

Is used for traffic to make the transition back to the normal path of the road. It extends downstream from the end of the workspace to the point where normal speed resumes.

**Traffic control person**

A trained and certified person responsible for controlling traffic.

**Transition area**

The section of roadway where road users are redirected from their normal path.

**Traffic control devices**

Devices to direct vehicle and pedestrian movement through an area in which normal traffic flow has been disrupted. This includes all signs, delineators, barricades and arrow boards.

**Traffic control zone**

The zone where normal traffic flow is disrupted by guiding traffic around an obstruction. This zone includes the work area and all areas affected by temporary traffic control devices.

**Transition area**

When redirection of the driver's normal path is required, traffic must be channeled from the normal path to a new path. This redirection is intended to occur at the beginning of the transition area.

**Truck mounted attenuator (TMA)**

An energy-absorbing device mounted on the rear of a crash truck, to deform on impact in a controlled manner.

**Upstream**

The area before the TTC work zone in the direction of traffic flow.

**Warning signs**

Warning signs providing advance notice of conditions on or adjacent to a road that will normally require a reduction in speed.

**Worksite or work area**

The area around which traffic is being diverted to enable work to be done. It is usually bound on one or more sides by traffic control set-up. It includes an area for use of equipment, stockpiling materials and the excavation or building site.





## Bibliography

The City of Calgary would like to acknowledge the following resource materials used in preparing this manual:

1. A Guide to Temporary Traffic Control in Work Zones, American Traffic Safety Services Association, 1998.
2. Alberta Temporary Traffic Control Guidelines Training Manual, Alberta Construction Safety Association and American Traffic Safety Services Association, 2000.
3. Design Bulletin #41/2006, Alberta Transportation and Infrastructure, December 2006.
4. Emergency Traffic Management, Calgary Fire Department, 2002.
5. Flagging Handbook, American Traffic Safety Services Association.
6. Flagpersons Handbook, Alberta Transportation and Infrastructure.
7. Flagperson Training Workbook, The Alberta Construction Safety Association, 1996.
8. Geometric Design Guide for Canadian Roads (1999 Edition), Transportation Association of Canada.
9. Johnston, M., Morrall, J.F., and Swanson B. "An In-Service Operational Review of Current Temporary Traffic Control Practices in Calgary", Transportation Association of Canada, 2002.
10. Manual on Uniform Traffic Control Devices (Millennium Edition, December 2000), U.S. Department of Transport, Federal Highway Administration.
11. Manual of Uniform Traffic Control Devices for Canada (4th Edition), Transportation Association of Canada, 1998.
12. Procedures for On-Street Construction Safety (2000 Edition), The City of Edmonton.
13. Roadside Design Guide, American Association of State Highway and Transportation Officials, 2002.
14. Temporary Conditions (Field Edition), Ontario Traffic Manual, 2001.
15. Traffic Accommodation in Work Zones (2nd Edition), Alberta Transportation and Infrastructure, 2001.
16. Worksite Temporary Traffic Control Manual, Engineering and Environmental Services Department, Transportation Department, The City of Calgary, 1991.
17. Workzone Operations: Best practices Guidebook, Federal Highway Administration (FHWA) and AASHTO, FHWA-OP-00-010, April 2000.
18. Z96-02 High-Visibility Safety Apparel, Canadian Standards Association, September 2002.



## **Appendix**

- A. Record of Temporary Traffic Control**
- B. Maximum Speed Ahead sign placement**
- C. Street Use Permit Application requirements**
- D. Hoarding Permit requirements**

# Appendix A

## RECORD OF TEMPORARY TRAFFIC CONTROL

PROJECT	ADDRESS	
WORK ORDER	CONTACT NAME	
PHONE #	CELL	FAX
COMPANY	DATE	
COMPLETED	PAGE	OF
	Inspected by	

Date yyyy/mm/dd	Time 24:hr	Traffic Control Plan	Type of Set-up	As per Plan	Type of Deficiency and Location	Photo Taken	Action Taken

Typical Types of Set-ups and Common Abbreviations:

- RLCA: Right Lane Closed Ahead
- LLCA: Left Lane Closed Ahead
- 2RLCA: Right Lanes Closed Ahead
- 2LLCA: Left Lanes Closed Ahead
- TWT or 2WTT: Two Way Traffic
- SWC: Sidewalk Closed
- HRDING: Hoarding Permit
  
- NPAT: No Parking Anytime
- NTT: No Through Traffic
- LTO: Local Traffic Only
- RC: Road Closed
- RLCA BD: Right Lane Closed Ahead Both Directions
- LLCA BD: Left Lane Closed Ahead Both Directions

## Appendix B

### Maximum Speed Ahead Sign Placement

The following chart identifies examples of speed reductions and the suggested minimum distances (m) between the maximum speed ahead sign and the gazetted speed sign. Refer to Chapter 5, Drawing 9 "Speed Reduction with Right Lane Closure."

Desired Speed Zone Transition Km/h		Suggested Minimum Placement Distance in Meters for "Maximum Speed Ahead" Signs	
50	40	75	
60	40	100	
70	40	225	
80	40	250	
90	40	275	(1)
60	50	75	
70	50	150	
80	50	250	
90	50	300	(2)
100	50	335	(3)
110	50	370	(4)
70	60	75	
80	60	150	
90	60	200	
100	60	250	
110	60	335	(5)
80	70	100	
90	70	175	
100	70	225	
110	70	300	(6)
90	80	75	
100	80	150	
110	80	200	
100	90	75	
110	90	150	
110	100	100	

- (1) Recommend intermediate transition zone 90 to 60 then 60 to 40.  
 (2) Recommend intermediate transition zone 90 to 70 then 70 to 50.  
 (3) Recommend intermediate transition zone 100 to 70 then 70 to 50.  
 (4) Recommend intermediate transition zone 110 to 80 then 80 to 50.  
 (5) Recommend intermediate transition zone 110 to 80 then 80 to 60.  
 (6) Recommend intermediate transition zone 110 to 90 then 90 to 70.

## Appendix C



### STREET USE PERMIT APPLICATION REQUIREMENTS

In order to obtain a Street Use Permit the following must be submitted to The Traffic Engineering Department. Contact Traffic Engineering for specific requirements.

#### Street Use Information:

REQUIRED RECEIVED

- |                          |                          |   |
|--------------------------|--------------------------|---|
| <input type="checkbox"/> | <input type="checkbox"/> | Reason for the street use   |
| <input type="checkbox"/> | <input type="checkbox"/> | Description of proposed street use  |
| <input type="checkbox"/> | <input type="checkbox"/> | Justification for the need of the street use  |
| <input type="checkbox"/> | <input type="checkbox"/> | Alternatives that were considered   |
| <input type="checkbox"/> | <input type="checkbox"/> | Complete schedule of planned street use including start and end dates, hours of work, and extent of street use at all times |

#### Scaled Engineering Drawing(s) & Notes Detailing:

REQUIRED RECEIVED

- |                          |                          |   |
|--------------------------|--------------------------|---|
| <input type="checkbox"/> | <input type="checkbox"/> | Extent of street use, including length, width and number of lanes, relative to existing curb, back of walk, property line, and road markings        |
| <input type="checkbox"/> | <input type="checkbox"/> | Location of excavation with planned saw cuts and depth of excavation  |
| <input type="checkbox"/> | <input type="checkbox"/> | Proposed temporary traffic to be employed   |
| <input type="checkbox"/> | <input type="checkbox"/> | Site fencing and/or access control to protect public safety   |
| <input type="checkbox"/> | <input type="checkbox"/> | Removal and/or relocation of any existing traffic control devices including signage, signals, and parking meters (complete with associated numbers) |
| <input type="checkbox"/> | <input type="checkbox"/> | Pedestrian accommodation (considering cyclists, children and people with special needs)   |
| <input type="checkbox"/> | <input type="checkbox"/> | Access for emergency vehicles   |
| <input type="checkbox"/> | <input type="checkbox"/> | Access to fire hydrants and water valves  |
| <input type="checkbox"/> | <input type="checkbox"/> | Parking of contractor and employee vehicles   |
| <input type="checkbox"/> | <input type="checkbox"/> | Method of platina to be employed during peak hours  |

Street Use Permit Application Requirements

- Any special requirements such as construction material or excavation material storage

**Other Items:**

REQUIRED RECEIVED

- An alternative plan to open the roadway in the event of unexpected circumstances
- Confirmation that arrangements have been made for asphalt and planned timing such that the road will be open to traffic for peak period as defined by Traffic Engineering
- Copy of excavation permit
- Transit approval
- Traffic impact study
- Tree Protection Plan (refer to the Tree Protection Bylaw 23M2002)
- Communication Plan
- \_\_\_\_\_
- \_\_\_\_\_
- \_\_\_\_\_

## Appendix D

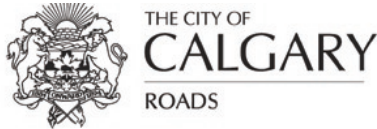

### HOARDING PERMIT APPLICATION REQUIREMENTS

In order to obtain a Hoarding Permit the applicant is required to submit documentation of the following to The Traffic Engineering Department. Contact Traffic Engineering for specific project requirements.

#### 1) Project Information:

- a) Description project and proposed street use
- b) Justification of the need for use of the street
- c) Alternatives that were considered
- d) Complete schedule of planned hoarding including start and end dates, hours of operation and extent of street use at all times

#### 2) Scaled Engineering Drawing(s) & Notes Detailing:

- a) Extent of proposed hoarding area, including length, width and number of lanes, relative to existing curb, back of walk, property line, and road markings
- b) Proposed temporary traffic to be employed
- c) Site fencing, overhead hoarding and access control to protect public safety
- d) Removal and/or relocation of any existing traffic control devices including signage, signals, and parking meters (complete with associated numbers)
- e) Corner visibility
- f) Location of stockpiling and temporary storage of excavation materials
- g) Locations of stockpiling and laydown areas for construction materials
- h) Location of storage of supplies and building materials
- i) Parking for contractor and employee vehicles
- j) Pedestrian accommodation (considering cyclists, children and people with special needs)
- k) Access for emergency vehicles
- l) Access to fire hydrants and water valves
- m) Construction vehicle access to the site
- n) Staging area (where required based on frequency of deliveries)
- o) Haul routes to minimize impact on adjacent streets (refer to the Truck Route Bylaw 60M90)
- p) Construction information signage to be posted on the hoarding fence (see template)

#### 3) Other Items (as required):

- a) An alternative plan to open the roadway in the event of unexpected circumstances
- b) Transit approval
- c) Traffic impact study
- d) Tree Protection Plan (refer to the Tree Protection Bylaw 23M2002)
- e) Communication Plan
- f) \_\_\_\_\_
- g) \_\_\_\_\_
- h) \_\_\_\_\_





