



MANUAL OF TEMPORARY  
TRAFFIC CONTROL  
ON CITY STREETS



*Embrace the Spirit • Vivez l'esprit*

PUBLIC WORKS DEPARTMENT  
2015



## FOREWORD

The Manual of Temporary Traffic Control on City Streets must be complied with, as mandated when work takes place on City streets by both The City of Winnipeg Streets By-Law 1481/77 and The City of Winnipeg Traffic By-Law 1573/77. The 2015 edition contains the following substantial changes as compared to the 2011 edition:

1. The term “in Work Areas” has been removed from the title to reflect use of the manual for non-construction related activities such as special events and film productions.
2. The Interpretations section now includes definitions for Designated Construction Zones, Work Areas and Work Zones. Directional, Full, Lane and Road Closures are distinguished. (Section 1.03)
3. Responsibilities and contacts for Construction Agencies, Traffic Management Branch, Customer Services Branch, Traffic Services Branch, Winnipeg Parking Authority, Winnipeg Transit and Traffic Signals Branch have been revised and expanded. (Section 2.00)
4. In addition to the previous requirement of the Construction Agency to contact the Public Works Department Traffic Management Branch to request approval for lane closures on a Regional Street during weekday peak periods, the Construction Agency is now also required to contact the Traffic Management Branch to request approval for any:
  - a. Long term lane closures (more than 2 hours) at any time, and;
  - b. Short term lane closures (between 30 minutes and 2 hours) on Regional Streets during weekday peak periods.
5. A checklist is provided outlining the general process and contact information that a Construction Agency is required to follow for a Regional Street lane closure request.
6. Time periods for requests, notifications and services have been identified.
7. An online Regional Street Lane Closure Request Form is now available: [winnipeg.ca/publicworks/Contact](http://winnipeg.ca/publicworks/Contact)
8. A Component Areas of a Temporary Work Zone section has been added. (Section 3.01)
9. Designated Construction Zone requirements have been identified in accordance with provincial regulations. (Section 3.04)
10. The Speed Control and Reduced Speed Limits section has been completely revised. (Section 3.05)
11. Flagging practices have been updated in accordance with provincial regulations. (Section 3.05, 3.06 and 5.02.G)
12. The Maintenance section has been expanded highlighting the requirement that temporary traffic control devices must be removed from the motorists’ view when not required. (Section 4.00)
13. A Temporary Traffic Control Devices and Illustrations section has been compiled with added requirements for arrow boards, variable message signs, barriers, end treatments and flagperson’s tools. Note that the use of channelization barrels is preferred over chevrons and yellow caution tape has been removed from the list of acceptable temporary traffic control devices. (Section 5.00)
14. Numerous warning signs, in addition to Designated Construction Zone signs, have been added. (Section 5.02)
15. The diamond shaped ‘Road Closed’ sign has replaced the diamond shaped ‘Barricade’ sign (WD-A50). (Section 5.02)
16. All illustrations of typical situations have been updated and new illustrations have been added to address closures of bike lanes and roundabouts. (Section 5.04)



**CITY OF WINNIPEG  
MANUAL OF TEMPORARY TRAFFIC CONTROL ON CITY STREETS**

<b>1.00</b>	<b>INTRODUCTION</b>	<b>PAGE</b>
1.01	Purpose of Manual-----	1
1.02	Scope -----	1
1.03	Interpretations-----	1
1.04	Revisions-----	2
1.05	Specifications for Traffic Control Devices-----	3
1.06	Information Seminars-----	3
1.07	Enforcement-----	3
<b>2.00</b>	<b>RESPONSIBILITIES AND CONTACTS</b>	
2.01	Construction Agency-----	4
2.02	Public Works Department Traffic Management Branch-----	7
	2.02.A Regional Street Lane Closures-----	7
	2.02.B Regional Street Lane Closures on Weekends, Public Holidays or at Night-----	8
	2.02.C Authorizing Regulatory Signs and Optional Designated Construction Zones-----	8
2.03	Public Works Department Customer Services Branch-----	8
2.04	Public Works Department Traffic Services Branch-----	9
2.05	Winnipeg Parking Authority, Winnipeg Transit and the Public Works Department Traffic Signals Branch-----	9
2.06	Emergency Work-----	10
<b>3.00</b>	<b>APPLICATION</b>	
3.01	Component Areas of a Temporary Work Zone-----	10
3.02	Bilingual Signing Area-----	13
3.03	Duration of Work-----	14
	3.03.A Long Term Work Zones (Closure for more than 2 hours)-----	14
	3.03.B Short Term Work Zones ----- (Closure greater than 30 minutes and up to 2 hours)-----	14
	3.03.C Mobile and Very Short Duration Work Zones (Work Zones that move continuously or intermittently, stopping at a fixed location for up to 30 minutes)-----	15
3.04	Designated Construction Zones-----	15
	3.04.A Roadwork Conditions that Require a Designated Construction Zone-----	16
	3.04.B Optional Designated Construction Zone-----	16
	3.04.C Designated Construction Zone Sign Setup-----	16
3.05	Speed Control and Reduced Speed Limits-----	19
	3.05.A Full Time Reduced Speed Limits-----	20
	3.05.B Daily Shift Reduced Speed Limits-----	20
	3.05.C Flagging-----	20
3.06	Flagperson Practices-----	22

	<b>PAGE</b>
3.07 Work Zone Considerations-----	22
3.07.A Lateral and Vertical Position of Traffic Control Devices-----	22
3.07.B Warning Flags-----	23
3.07.C Traffic Lane Clearances-----	23
3.07.D Construction Equipment-----	23
<b>4.00 MAINTENANCE</b>	
4.01 General-----	23
4.01.A Work Area Enclosures-----	24
4.01.B Removal of Traffic Control Devices-----	24
<b>5.00 TEMPORARY TRAFFIC CONTROL DEVICES AND ILLUSTRATIONS</b>	
5.01 General-----	24
5.02 Traffic Control Devices-----	24
5.02.A Warning, Regulatory and Information Signs-----	25
5.02.B Barrels, Cones, Markers and Panels-----	28
5.02.C Flashing or Sequential Arrow Traffic Control Devices (Arrow Boards)-----	30
5.02.D Variable Message Signs-----	31
5.02.E Barricades-----	31
5.02.F Barriers-----	33
5.02.G Flagperson's Tools, Road Marking Tape and Snow Fencing-----	34
5.03 Illustration Symbols-----	35
5.04 Illustrations of Typical Situations-----	36
<b>FIGURE ILLUSTRATIONS OF TYPICAL SITUATIONS</b>	
1a Long Term Right Lane Closure on a Multi-Lane Street-----	37
1b Long Term Right Lane Closure on a Multi-Lane Street (using chevrons in place of barrels)-----	38
2 Long Term Right Lane Closure on a Four Lane Undivided Highway Maintaining Two Lanes in the Closure Direction (Two-Lane Shift)-----	39
3 Long Term Closure of Half of a Four Lane Undivided Street-----	40
4 Long Term Closure of Two out of Three Lanes on a Multi-Lane Street-----	41
5 Long Term Closure of Two out of Four Lanes on a Multi-Lane Street (Two-Lane Shift)-----	42
6 Long Term Closure of Two out of Four Lanes on a Multi-Lane Street including an Intersection (Two-Lane Shift)-----	43
7 Long Term Closure of Non-Adjacent Lanes on a Multi-Lane Street-----	44
8 Long Term Closure of One out of Three Lanes on a Multi-Lane Street (Two-Lane Shift)-----	45
9 Long Term Closure of One out of Three Lanes on a Multi-Lane Street-----	46
10 Long Term Closure of Centre Lane or Lanes of a Divided Street-----	47
11 Long Term Closure of Centre Lane or Lanes of a Multi-Lane Street (Left Turn Lane Alternative)-----	48
12 Long Term Closure of Centre Lane or Lanes of a Multi-Lane Street (Right Turn Lane Alternative)-----	49
13 Long Term Closure Adjacent to an Intersection of a Four Lane Undivided Street-----	50
14 Long Term Closure Within an Intersection of a Four Lane Undivided Street-----	51

<b>FIGURE</b>	<b>PAGE</b>
15	Long Term Closure on a Horizontal Curve-----52
16	Long Term Closure on a Vertical Curve-----53
17	Long Term Diversion Around a Work Area Using Shoulder-----54
18	Use of Flagpersons for On-Street and Off-Street Construction----- 55
19	Long Term Bike Facility Closure With a Detour-----56
20	Long Term Bike Facility Closure Without a Detour-----57
21	Long Term Closure of a Sidewalk With Pedestrians Diverted onto Roadway----- 58
22	Long Term Covered Walkway on Roadway----- 59
23	Long Term Closure of a Sidewalk-----60
24	Long Term Partial Blockage of a Sidewalk-----61
25	Long Term Directional Closure of a Non-Regional Street-----62
26	Long Term Closure of Half of a Non-Regional Street----- 63
27	Long Term Full Closure of One Block of a Non-Regional Street----- 64
28	Long Term Full Closure of Several Blocks of a Non-Regional Street-----65
29	Long Term Closure of One Quadrant of a Roundabout on a Non-Regional Street-----66
30	Long Term Maintenance of Granular Surface Roadways-----67
31a	Short Term (Greater than 30 minutes and up to 2 hours) Closure of Curb Lane or Lanes - Speed Limit 50 km/h or 60 km/h----- 68
31b	Short Term (Greater than 30 minutes and up to 2 hours) Closure of Curb Lane or Lanes - Speed Limit 70, 80 or 90 km/h----- 69
32a	Short Term (Greater than 30 minutes and up to 2 hours) Closure of Median Lane or Lanes - Speed Limit 50 km/h or 60 km/h----- 70
32b	Short Term (Greater than 30 minutes and up to 2 hours) Closure of Median Lane or Lanes - Speed Limit 70, 80 or 90 km/h----- 71
33a	Short Term (Greater than 30 minutes and up to 2 hours) Closure of Centre Lane or Lanes - Speed Limit 50 km/h or 60 km/h----- 72
33b	Short Term (Greater than 30 minutes and up to 2 hours) Closure of Centre Lane or Lanes - Speed Limit 70, 80 or 90 km/h-----73
34	Short Term (Greater than 30 minutes and up to 2 hours) Closure on a Horizontal Curve-----74
35	Short Term (Greater than 30 minutes and up to 2 hours) Closure on a Vertical Curve----- 75
36a	Short Term (Greater than 30 minutes and up to 2 hours) Closure of a Curb Lane or Median Lane Adjacent to an Intersection Speed Limit 50 km/h or 60 km/h----- 76
36b	Short Term (Greater than 30 minutes and up to 2 hours) Closure of a Curb Lane or Median Lane Adjacent to an Intersection Speed Limit Speed Limit 70, 80 or 90 km/h----- 77
37	Short Term (Greater than 30 minutes and up to 2 hours) Closure Within an Intersection Eight Lane and Six Lane Divided Highways Speed Limit 50 km/h or 60 km/h-----78
38	Mobile and Very Short Duration Work Zones----- 79
<b>APPENDIX</b>	
List of Regional Streets-----	81





# MANUAL OF TEMPORARY TRAFFIC CONTROL ON CITY STREETS

## 1.00 INTRODUCTION

### 1.01 Purpose of Manual

This Manual specifies the minimum requirements to maintain safe conditions for motorists, cyclists, pedestrians and workers where construction, maintenance, utility work, or other temporary conditions such as special events are present within a public right-of-way in The City of Winnipeg. Everyone who undertakes work within a street is responsible for the safety of the public and the workers involved. This is best achieved by way of effective traffic control and the application of the guidelines for work zones provided herein.

### 1.02 Scope

This Manual contains general principles and detailed temporary traffic control methods for many typical circumstances. The responsibilities of any City Department, utility company or private contractor undertaking work within a public right-of-way in The City of Winnipeg are also defined herein.

### 1.03 Interpretations

For purposes of this Manual, the following words and expressions shall have the meaning indicated below.

- (1) “**Construction Agency**” shall mean any City Department, utility company or private contractor, or any other persons responsible for the undertaking of work on any section of a public right-of-way in The City of Winnipeg.
- (2) “**Designated Construction Zone**” shall mean a construction work zone where fines for speeding are doubled.
- (3) “**Directional Closure**” shall mean the prohibition of one direction of traffic while the opposing direction of traffic is maintained.
- (4) “**Full Closure**” shall mean the complete prohibition of all directions of traffic on a roadway.
- (5) “**Information and Warning Signs**” shall mean all signs or devices that convey warning or essential information to the right-of-way user as specified in this Manual and shall include such devices as signs, barricades, traffic cones, and any other device of a similar nature that is specified and approved herein for use within a public right-of-way in The City of Winnipeg for this purpose.
- (6) “**Lane Closure**” shall mean a closure of an individual lane or lanes for the purposes of work while maintaining traffic flow in the direction of travel.

(7) “**Long Term Work Zone/Closure**” shall refer to a lane, directional or full closure with a duration of more than 2 hours.

(8) “**Manual**” shall mean the Manual of Temporary Traffic Control on City Streets.

(9) “**Mobile & Very Short Duration Work Zone/Closure**” shall refer to a lane, directional or full closure that moves continuously or intermittently, stopping at a fixed location for up to 30 minutes.

(10) “**Regional Street**” shall mean those streets listed in Schedule “E” of the most recent City of Winnipeg Streets By-law No. 1481/77. Note that a list of the Regional Streets is included in the Appendix to this Manual.

(11) “**Regulatory Signs**” shall mean those signs that require motorists to take certain action, and, which are enforceable.

(12) “**Road Closure**” shall mean the complete closure of a roadway.

(13) “**Short Term Work Zone/Closure**” shall refer to a lane, directional or full closure with a duration greater than 30 minutes and up to 2 hours.

(14) “**Street**” shall mean any place or way, including any structure forming part thereof, which or any part of which has been dedicated as a roadway, lane, avenue, road or highway pursuant to *The Real Property Act*. In addition to the roadway, it includes all shoulders, curbs, boulevards and sidewalks located within those boundaries.

(15) “**Weekday Peak Periods**” shall mean between the hours of 07:00 to 09:00 and 15:30 to 17:30, Monday to Friday.

(16) “**Work Area**” shall mean the road surface where repairs are being made, or the road surface immediately adjacent to the repairs being made. This “work area” includes additional room in the lane closure required for material storage, work vehicles, equipment, etc. Work area can also represent closure areas for special events and film productions.

(17) “**Work Zone**” shall mean a section of the roadway between the first advance warning sign and the point beyond the activity area where traffic is no longer affected.

#### **1.04 Revisions**

This Manual will be revised from time to time as the need arises. The most current version of this Manual and related information can be found at: [winnipeg.ca/publicworks/InformationAndResources/TrafficControl/manual\\_of\\_temp\\_traffic\\_control.asp](http://winnipeg.ca/publicworks/InformationAndResources/TrafficControl/manual_of_temp_traffic_control.asp)

Any suggestions for revision or improvement should be forwarded to the Traffic Studies Engineer, Traffic Management Branch of The City of Winnipeg at 101-1155 Pacific Avenue, R3E 3P1.

### **1.05 Specifications for Traffic Control Devices**

Many of the temporary traffic control devices and guidelines that apply to construction and maintenance activities in Winnipeg are included in the current edition of the Manual of Uniform Traffic Control Devices for Canada (M.U.T.C.D.C.), published by the Transportation Association of Canada, 2323 St. Laurent Boulevard, Ottawa, Ontario, K1G 4J8. Signs and other traffic control devices that are legal for use on streets in The City of Winnipeg for temporary traffic control are authorized for use through their inclusion in Manitoba Regulation 264/88, 300/89 and 145/2014. ***It is illegal to use signs within the City's public right-of-ways that are not approved in these Manitoba Regulations.***

Full-scale drawings of all traffic signs described in this Manual are available from The City of Winnipeg Public Works Department, Engineering Division, at 1155 Pacific Avenue.

The design, including colour and dimensions, of all traffic control signs and other devices utilized must conform to the specifications set out in Section 5.02. It should be noted that these dimensions are minimums and in some cases larger signs may be required. As of January 1, 2012, all retroreflective sheeting on temporary traffic control signs, barricades and devices must use a minimum Type VIII retroreflective sheeting (ASTM D4956).

Under no circumstances are hand painted lettering, diagrams, or symbols permitted.

### **1.06 Information Seminars**

The Public Works Department conducts information seminars annually in the spring (or by request) to review the requirements outlined in this Manual. For more information call the Traffic Services Branch at (204) 986-5178.

### **1.07 Enforcement**

The Highway Traffic Act of the Province of Manitoba assigns to The City of Winnipeg the authority to regulate traffic movement on public streets under its jurisdiction. In turn, The City of Winnipeg's Traffic By-law No. 1573/77 and Streets By-law No. 1481/77 mandates the use of this *Manual of Temporary Traffic Control on City Streets* (Manual) and the devices contained herein for use in work areas on City streets.

Requirements identified in this Manual are subject to enforcement by City of Winnipeg Streets Constables. Violations of these requirements may be subject to the issuance of stop work orders and/or fines as indicated in The City of Winnipeg Streets By-Law 1481/77 (Schedule "H").

## **2.00     RESPONSIBILITIES AND CONTACTS**

### **2.01     Construction Agency**

The Construction Agency is responsible for:

- Contacting the Traffic Management Branch for long term lane closure requests on Regional Streets. In general, 3 business days' notice is required; however, more complex projects such as full or directional closures, median crossovers and Designated Construction Zones require 2 weeks' notice.
- Contacting the Traffic Management Branch for short term lane closure requests during weekday peak periods (7:00-9:00 and/or 15:30-17:30 Monday-Friday) on Regional Streets.
- Contacting the Traffic Management Branch for long term sidewalk and/or bike lane closures on Regional Streets.
- Securing the necessary permits for the project.
- Contacting and coordinating with the Traffic Services Branch, the Winnipeg Parking Authority, Winnipeg Transit and the Traffic Signals Branch as specified either by this Manual, by the Traffic Management Branch and/or in the Permit issued by the City. Most services require a minimum of 3 business days' notice; however, more complex projects such as full or directional closures, median crossovers and Designated Construction Zones require 2 weeks' notice.
- Contacting neighbouring properties if access is affected.
- Placing, maintaining and removing the appropriate temporary traffic control devices as specified by this Manual, by the Traffic Management Branch and/or in the Permit issued by the City.
- Placing Designated Construction Zone signs in accordance with Section 3.04 of this Manual.
- Applying for a temporary posted speed limit reduction to the Traffic Management Branch when appropriate.
- Prominently posting the name and emergency telephone number of the Construction Agency undertaking the work on a sign in the work area.
- Using steel plates to cover excavations and reopen closed lanes during weekday peak periods when deemed feasible by the Construction Agency.
- Providing for the safety of the worker.
- Providing for the safety and convenience of motorists, cyclists and pedestrians.
- Ensuring that all temporary traffic control devices are removed from the street, or otherwise hidden from view, whenever they are no longer appropriate.
- Contacting the Traffic Management Branch to report any changes to the location, limits or duration of any lane closures.
- Notifying of lane closure reopening to the Traffic Management Branch on Regional Streets.
- Reimbursing the City for all costs incurred arising from placement of traffic control devices by The City of Winnipeg in connection with works undertaken by the Construction Agency.

The general process that a Construction Agency should follow for a lane closure is outlined in the checklist titled *General Checklist for Regional Lane Closures*. This list is intended as a general guideline and does not cover all situations.

A list of Regional Streets is appended to the end of this Manual. For the most current list of Regional Streets, please refer to Schedule “E” of The City of Winnipeg Streets By-law No. 1481/77.

Despite the responsibilities of a Construction Agency above, a City Department, utility company, private contractor or any other person acting in a supervisory role for works undertaken on a City Street has a duty to ensure that the provisions prescribed by this Manual are being followed.

### General Checklist for Regional Lane Closures

**Note:** This list is a general guideline, is not all inclusive and does not apply to emergency situations. Further details are described in this Manual. Most services require at least **3 business days' notice**. Complex projects including full/directional closures require at least **2 weeks' notice**.

**Before the Closure:**

Is the closure duration > 2 hours on a Regional Street? <b>OR</b> Is the closure duration < 2 hours on a Regional Street during a weekday peak period?	if YES contact...	<ul style="list-style-type: none"> <li>Traffic Management for approval conditions and temporary traffic control requirements via the online form, email or phone: Form: <a href="http://winnipeg.ca/publicworks/Contact">winnipeg.ca/publicworks/Contact</a> Email: <a href="mailto:PWDLaneClosures@winnipeg.ca">PWDLaneClosures@winnipeg.ca</a> Phone: (204) 986-5640</li> </ul>
Do I have the required permits?	if NO contact...	<ul style="list-style-type: none"> <li>Use of Street Permit – (204) 986-6006</li> <li>Excavation Cut Permit – (204) 986-3184</li> <li>Crossing Permit – (204) 986-6006</li> <li>Other – 311</li> </ul>
Do I need: <ul style="list-style-type: none"> <li>Parking removal?</li> <li>Regulatory signs authorized by Traffic Management installed?</li> <li>Full/directional closure on a Regional Street?</li> </ul>	if YES contact...	<ul style="list-style-type: none"> <li>Traffic Services – (204) 986-5178 <i>Note: Provide Billing Address with Contact Information.</i></li> </ul>
Do I need parking meters covered?		<ul style="list-style-type: none"> <li>Winnipeg Parking Authority (204) 986-5007</li> </ul>
Is a Transit stop or route affected?		<ul style="list-style-type: none"> <li>Transit – (204) 986-6935 OR (204) 986-5745</li> </ul>
Does a Traffic Signal need to be covered as approved by Traffic Management?		<ul style="list-style-type: none"> <li>Traffic Signals – (204) 451-4482</li> </ul>

**During the Closure:**

Do I need: <ul style="list-style-type: none"> <li>To change the duration of the project?</li> <li>To change the number or location of lanes closed?</li> <li>Additional regulatory signs or temporary traffic control?</li> </ul>	if YES contact...	<ul style="list-style-type: none"> <li>Traffic Management - (204) 986-5640 OR <a href="mailto:PWDLaneClosures@winnipeg.ca">PWDLaneClosures@winnipeg.ca</a></li> </ul>
Is the temporary traffic control properly placed and maintained?		
Is the work zone secure for overnight?		

**After the Closure:**

Have the lane(s) been reopened?	if YES contact...	<ul style="list-style-type: none"> <li>Traffic Management - (204) 986-5640 OR <a href="mailto:PWDLaneClosures@winnipeg.ca">PWDLaneClosures@winnipeg.ca</a></li> </ul>
Do regulatory signs, parking, transit stops or signals need to be restored?		<ul style="list-style-type: none"> <li>Traffic Services – (204) 986-5178</li> <li>Winnipeg Parking Authority (204) 986-5007</li> <li>Transit – (204) 986-6935 OR (204) 986-5745</li> <li>Traffic Signals – (204) 451-4482</li> </ul>

## **2.02 Public Works Department Traffic Management Branch**

The Traffic Management Branch can be contacted online through the Regional Street Lane Closure Request Form ([winnipeg.ca/publicworks/Contact](http://winnipeg.ca/publicworks/Contact)), via email at [PWDLaneClosures@winnipeg.ca](mailto:PWDLaneClosures@winnipeg.ca) or by phone at (204) 986-5640. The Traffic Management Branch is responsible for:

- Approving the time frame for all long term Regional Street lane closures.
- Determining temporary traffic control requirements in consultation with the Traffic Services Branch.
- Determining advance information sign requirements.
- Authorizing turn restrictions.
- Authorizing temporary posted speed limit reductions.
- Authorizing optional Designated Construction Zones.
- Authorizing traffic on shoulders for long term closures.
- Notifying Traffic Services Branch, Customer Services Branch, Winnipeg Transit and/or Traffic Signals Branch of authorizations as required.
- Initiating media releases when required.
- Maintaining the City's Regional Streets Lane Closures website.

### **2.02.A Regional Street Lane Closures**

When a long term lane closure or a short term lane closure during peak periods is required on a Regional Street, the Traffic Management Branch must be contacted to approve the closure timing (times and/or dates) and temporary traffic control requirements (turn restrictions, etc.). This is to ensure that no conflicting projects are near the location and to provide public notice via the Regional Streets Lane Closures website and/or media release. This assists in minimizing the impact to safe and efficient movement of traffic. Generally a minimum of 3 business days' notice is required prior to the start of the lane closure, however for more complex projects including full and directional closures, 2 weeks' notice is required. When contacting the Traffic Management Branch, please provide the following information:

- Name of company or agency
- Contact name
- Phone number
- Email address
- Description of activity
- Lane closure location and extents
- Number of lanes closed including sidewalks and/or bike lanes
- Description of temporary traffic control
- Any planned changes to the extent or configuration of the lane closures during the work
- Proposed start date
- Proposed end date

### **2.02.B Regional Street Lane Closures on Weekends, Public Holidays or at Night**

Many Regional Streets operate at or above capacity in at least one direction during either or both of the weekday peak periods, 07:00 to 09:00 and 15:30 to 17:30 Monday-Friday. Any lane closures during these periods in the direction(s) of peak travel can significantly increase congestion and delay, negatively impacting the public. Congestion and delay on Regional Streets is of particular concern in the vicinity of river crossings and on streets with limited access where alternative routes are not readily available.

The following motion was approved by Council on September 27, 2012:

*“That where it is deemed necessary by the Director of Public Works or their designate [Traffic Management Branch], contractors [Construction Agencies] doing work on Regional Streets for private customers be required to do all things necessary to expedite completion of the work, including pavement restoration, through the use of 24 hour and weekend work activities and steel plating of excavations during the a.m. and/or p.m. peak rush hour periods.”*

Under certain circumstances, as required by the above motion, it may be necessary to undertake non-emergency work during weekends, night time hours (between 18:00 and 06:00), or on a public holiday. Such a requirement would normally occur only where the work would cause significant disruption to vehicular or pedestrian traffic during normal working hours as identified by the Traffic Management Branch.

### **2.02.C Authorizing Regulatory Signs and Optional Designated Construction Zones**

The following requests require approval by the Traffic Management Branch:

- Requests for temporary turn restrictions, yield or stop signs.
- Temporary posted speed limit reductions.
- Optional Designated Construction Zones.

Specific details on the requirements for temporary posted speed limit reductions and optional Designated Construction Zones can be found in Sections 3.04 and 3.05.A respectively.

### **2.03 Public Works Department Customer Services Branch**

The Customer Services Branch is responsible for issuing:

- Use of Street Permits – (204) 986-6006
  - All activities that impede or temporarily occupy the right-of-way.
- Street Excavation Cut Permits – (204) 986-3184
  - For any excavation in or under a road, sidewalk or boulevard.
- Crossing Permits - (204) 986-6006 on Regional Streets
  - At any time an applicant requires to drive or tow a vehicle across a curb, boulevard or sidewalk other than at a private approach.

Questions regarding other permits should be directed to 311.



## **2.04 Public Works Department Traffic Services Branch**

The Traffic Services Branch, which can be contacted at (204) 986-5178, is responsible for:

- Placing and maintaining all regulatory signs and traffic control devices authorized by the Traffic Management Branch, with the exception of the 'KEEP RIGHT/KEEP LEFT' sign (RB-25 / RB-25L) which may be installed by the Construction Agency. Common examples include parking restrictions, stopping restrictions, turn restrictions and diamond lane removal.
- Providing guidance in selecting the appropriate temporary traffic control and work zone schemes.
- Placing, maintaining and removing of regulatory, guidance and information signs for traffic control purposes in the following situations:
  - (a) Full or directional closures on a Regional Street.
  - (b) Traffic routed across a median on a divided street.
  - (c) Full closure of a non-regional street where the requirements for regulatory signs (turn restrictions, bus stop relocations, etc.) to implement the closure is significant.
- Where a Designated Construction Zone with a temporary posted speed limit reduction has been approved, Traffic Services will be responsible for placing all of the advance signs and 'Construction Ends' (TC-4) signs. In the above instances, the Construction Agency is still responsible for all other temporary traffic control including but not limited to barricades, barrels and tall cones. Please refer to Section 3.04 for Designated Construction Zone requirements.
- Attending a preconstruction meeting for City of Winnipeg Capital Projects to advise as to traffic control requirements and provide input during construction as required.

For general regulatory sign installation requests at least **3 business days' notice** is required, however for more extensive installation requests including full or directional closures, median crossings and Designated Construction Zones with temporary posted speed limit reductions at least **2 weeks' notice** is requested. Please provide billing address along with contact information when making requests.

## **2.05 Winnipeg Parking Authority, Winnipeg Transit and the Public Works Traffic Signals Branch**

When the work zone affects parking meters or paystations, the Winnipeg Parking Authority must be notified at least 3 business days' prior to the work commencing at (204) 986-5007. The Winnipeg Parking Authority will install necessary hooding and restore normal operations when notified.

When the work zone affects a transit stop or transit route, Winnipeg Transit must be notified at (204) 986-6935 or (204) 986-5745.

If the lane closure affects a traffic signal or pedestrian corridor, Traffic Signals Branch requires a minimum of 3 business days' notice prior to work commencing at (204) 451-4482. Where turning is restricted, as authorized by Traffic Management, the corresponding turn signal head, if present, needs to be covered by the Traffic Signals Branch. Any turn restriction signs would still be placed by Traffic Services Branch.

## **2.06 Emergency Work**

In emergency situations that threaten public safety or are a public hazard, the Construction Agency responsible for the work performed is authorized to eliminate the public hazard immediately. However, the following authorities must be notified:

- Police Service Dispatch – (204) 986-6222
- Fire Paramedic Service Dispatch – (204) 986-8485
- Traffic Management Branch – (204) 986-5640 or by email  
[PWDLaneClosures@winnipeg.ca](mailto:PWDLaneClosures@winnipeg.ca)
- Winnipeg Transit if the work affects a transit route – (204) 986-5745
- Traffic Signals Branch if a traffic signal requires repair – (204) 451-4482

In all other respects, the intent and requirements of the Manual shall apply.

## **3.00 APPLICATION**

### **3.01 Component Areas of a Temporary Work Zone**

In general, to provide motorists, cyclists and pedestrians with sufficient information to safely and effectively pass through or around a work zone, there are five distinct areas, as shown in the following illustration, within a work zone:

- Advance Warning Area
- Approach Area
- Taper Area
- Activity Area
- Termination Area

#### Advance Warning Area

The advance warning area alerts motorists of road work ahead and provides time and distance to adjust to changes in road conditions prior to reaching them. This may vary from a single traffic control device to a series of traffic control devices.

#### Approach Area

In the approach area, the motorist is informed of possible lane changes, speed reductions, and passing restrictions in advance so that they may adjust their travel path accordingly. This may vary from a single traffic control device to a series of traffic control devices.

#### Taper Area

A taper area is used to direct traffic from the normal path of travel to a new path by placing traffic control devices to guide motorists past all roadway obstructions. The taper area is used to safely and effectively close the lanes and must be obvious to drivers.

### Activity Area

The activity area is the portion of roadway closed to traffic and is reserved for the exclusive use of workers, equipment and material storage. The activity area may be a fixed location or may move as the work progresses. The activity area includes longitudinal buffer space, the work area, the traffic space, and the lateral buffer space:

- a) Longitudinal buffer space provides protection for traffic and workers between the end of the taper area and the work area.
- b) Work area is reserved for workers, equipment and material storage.
- c) Traffic space allows traffic to pass through the activity area.
- d) Lateral buffer provides for a separation between the work space and the adjacent traffic space.

As indicated in the M.U.T.C.D.C. Part D – Temporary Conditions, Section D4.2.2; it may not be possible to provide longitudinal buffer space in urban areas due to space restrictions. However, should the situation allow, a longitudinal buffer space is recommended.

### Termination Area

The termination area allows motorists to transition back to the normal path of travel. A downstream taper is provided to allow vehicles to move back into the closed lane(s). The termination area is optional in most situations but is required in a two-lane shift scenario (Figures 2 and 8) only.

## COMPONENT AREAS OF A TEMPORARY WORK ZONE

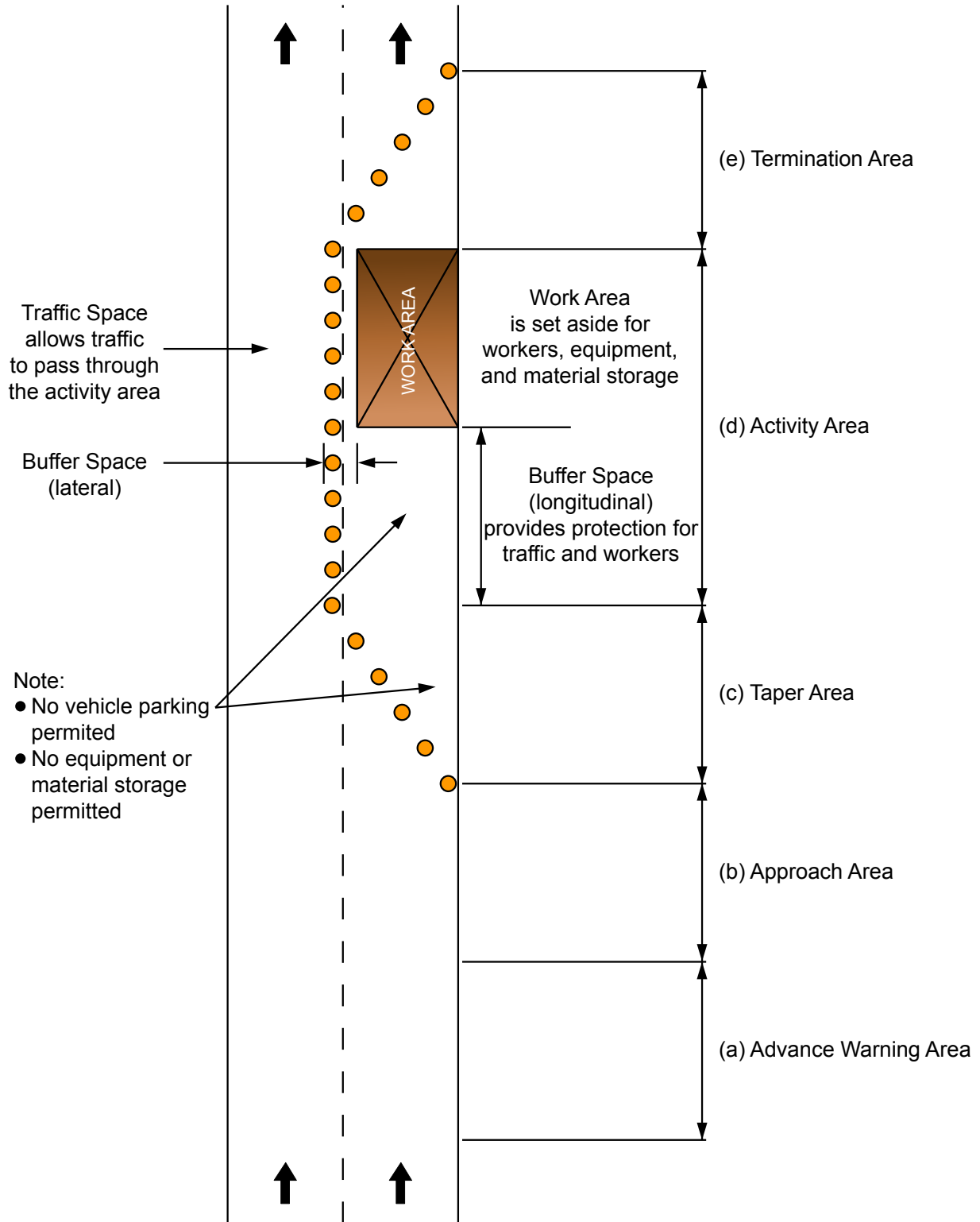

### 3.02 Bilingual Signing Area

All traffic control signs in the portion of St. Boniface defined in the map below must be in both official languages, English and French. The majority of signs presently used are symbolic, however, those signs that have a written message must be in both languages. This includes all temporary traffic control signs. Those signs that have a written message have been added to this Manual in Section 5.02.A.

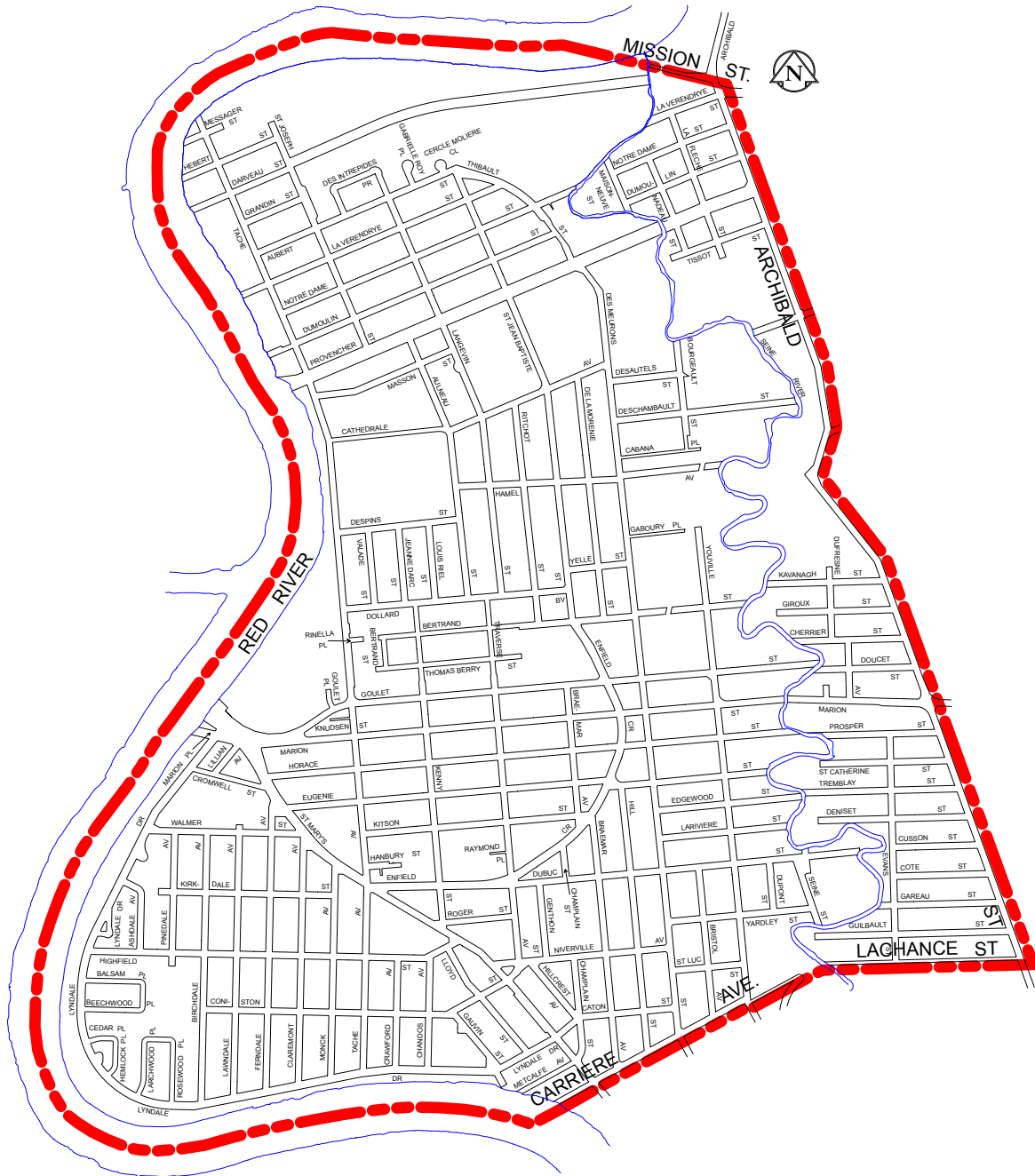

**Bilingual Portion of St. Boniface**

### **3.03 Duration of Work**

This manual provides for three work duration categories:

- Long term;
- Short term; and
- Mobile / Very short term.

Each has their own temporary traffic control requirements, as outlined below.

#### **3.03.A Long Term Work Zones (closure for more than 2 hours)**

Use of long term sign set ups, as shown in Figures 1 through 30 in Section 5.04, are required if the closure exceeds 2 hours.

Due to the height of the signs and the directionality, chevrons are useful for some situations and may still be used in place of channelization barrels (see Figure 1b). Channelization barrels, as shown in Section 5.02.B, are preferred over the use of chevrons. Similarly, tall cones are preferred over the use of construction markers in long term sign setups. Note that traffic cones are not permitted in long term sign setups.

#### **3.03.B Short Term Work Zones (closure greater than 30 minutes and up to 2 hours)**

Closures that are in place for a period greater than 30 minutes but less than 2 hours may use a modified signing approach, as shown in Section 5.04 Figures 31a to 37, if the closure meets the following guidelines:

- The closure shall not exceed 2 hours duration.
- No more than two lanes are closed at any one time and there must be at least one other traffic lane available for that direction of travel.
- The closure must be supplemented with advance warning signs TC-2 (Roadwork) and TC-5 (Temporary Lane Closed Ahead) or WD-17 (Double Arrow) when used on streets with 70, 80 or 90 km/h posted speed limits. Use of a flashing or sequential arrow traffic control device is recommended on these higher speed limit streets.
- Where visibility of the work zone is limited by a horizontal curve, the closure must be set up 100 m in advance of the horizontal curve and a line of traffic cones shall be extended around the horizontal curve to the work area.
- Where visibility of the work zone is limited by a vertical curve, the beginning of the short term sign setup must occur on the level section of highway prior to the start of the vertical curve and be carried through to the work area.
- The closure may not be used at night during hours of darkness without written consent from the Traffic Management Branch ((204) 986-5640 or email [PWDLaneClosures@winnipeg.ca](mailto:PWDLaneClosures@winnipeg.ca)). Use of a flashing or sequential arrow traffic control device is required for any work at night. Closures that do not meet the above noted guidelines must be signed as a long term work zone.

### **3.03.C Mobile and Very Short Duration Work Zones (work zones that move continuously or intermittently, stopping at a fixed location for up to 30 minutes)**

For mobile and very short duration work zones, the time required to setup and remove extensive sign setups can exceed the time required to perform the work. Therefore, flashing beacons, arrow boards, variable message signs, and buffer vehicles are to be used to provide adequate traffic control, minimize exposure of workers to traffic and ensure that work is completed in a timely manner. Setups described in Section 5.04 Figure 38, can be used for mobile and very short duration work zones if the work zone meets the following guidelines:

- The closure shall not exceed 30 minutes duration.
- Mobile and very short duration work zones are not permitted on Regional Streets during weekday peak periods.
- Only one lane is closed at any one time and there must be at least one other lane available for that direction of travel.
- A buffer vehicle equipped with a flashing or sequential arrow traffic control device must be used where visibility of the work zone is limited by horizontal or vertical curves (examples: bridges, overpasses or underpasses). The buffer vehicle should be located at the most visible location available.
- On streets with a posted speed limit of 70, 80 or 90 km/h, a flashing or sequential arrow traffic control device is required.
- A flashing or sequential arrow traffic control device is required at night.

Closures that do not meet the above noted guidelines must be signed using short term or long term setups. Truck or trailer mounted impact attenuators (also known as crash cushions) are recommended at the beginning of a mobile or very short duration closure on a roadway with a posted speed limit of 70 km/h or higher.

### **3.04 Designated Construction Zones**

In December 2013, the Government of Manitoba passed Highway Traffic Act (HTA) amendments intended to double the set fines for speeding in a Designated Construction Zone (DCZ). The amendments authorize double fines for speeding:

- Whether or not there are workers/equipment present; and
- Whether or not there is a reduction in the maximum speed within the DCZ.

The amendments require construction agencies to establish DCZs in some circumstances and allow for optional use of DCZs in other circumstances. Wherever DCZs are established they must be identified using the signage prescribed in the Provincial Designated Construction Zones Regulation 145/2014.

The DCZ requirements were implemented on May 16, 2014. Traffic authorities, or Construction Agencies working on their behalf, are responsible to establish DCZs and to identify them in accordance with the regulation. Note that posted speed limits remain unchanged when a DCZ is established unless authorized as described in the following sections.

### **3.04.A Roadwork Conditions that Require a Designated Construction Zone**

A Construction Agency must set up a work zone as a DCZ if the work being undertaken on a road meets **ALL** of the following conditions:

1. Work is on the roadway portion of a street, i.e. the area of a street where vehicles travel, this does not include the shoulder, sidewalk or ditch/median;
2. Work is 4 hours or more in duration;
3. Work is on a paved roadway; and
4. Work is on a roadway where the maximum posted speed is 80 km/h or more.

If one or more of the above conditions does not apply to the work being undertaken, then the Construction Agency is not required to establish a DCZ. For example, a Construction Agency is not required to establish a DCZ if the work is taking place on a gravel road; or on a road where the regular maximum speed is 50 km/h; or when the work is on the shoulder/sidewalk.

### **3.04.B Optional Designated Construction Zone**

When roadwork conditions do not meet the criteria for a required DCZ, the Construction Agency may request an optional DCZ. To request an optional DCZ the Construction Agency must submit the *Designated Construction Zone and/or Speed Limit Reduction Request Form* from Section 3.05 for approval by the Traffic Management Branch ((204) 986-5640 or email [PWDLaneClosures@winnipeg.ca](mailto:PWDLaneClosures@winnipeg.ca)). To be considered as an optional DCZ, the work being undertaken must be road construction, reconstruction, widening, improvement, repair, or other similar work in relation to the road.

### **3.04.C Designated Construction Zone Sign Setup**

The following diagram shows the basic DCZ sign setup when there is no associated reduction in maximum speed. This set up also applies where the maximum speed is not reduced but flagpersons and appropriate associated signs (as detailed in Section 3.06) are used to slow traffic.

The City of Winnipeg Traffic Management Branch may reduce the maximum speed in all or part(s) of a DCZ if it meets the requirements set out in Section 3.05.A of this Manual. In these cases, The City of Winnipeg Traffic Services Branch is responsible for erecting/placing all associated DCZ signs in accordance with the regulation, as well as any speed limit signs. Please refer to Section 3.05 to request an optional DCZ and/or posted speed limit reduction.



CITY OF WINNIPEG  
DESIGNATED CONSTRUCTION ZONE

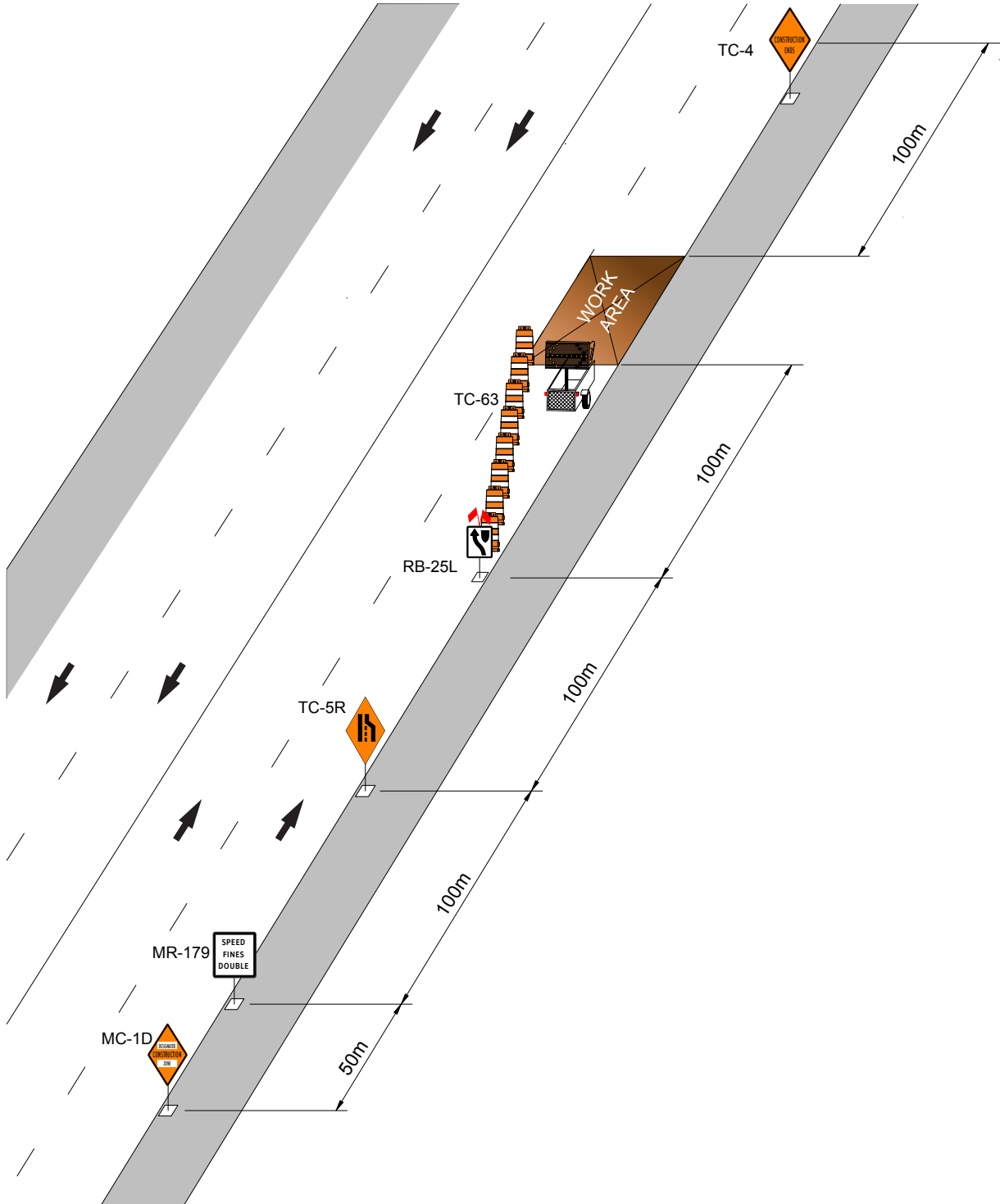

The Construction Agency is responsible to erect/place signs identifying the beginning and end of a DCZ in accordance with the regulation, as follows:

a) 'Designated Construction Zone' Sign:

On the roadway under construction, the beginning of a DCZ must be identified with the 'Designated Construction Zone' (MC-1D) sign (minimum size 900 mm x 900 mm). This sign is used in place of the 'Roadwork' (TC-2) sign indicated elsewhere in this manual. The 'Designated Construction Zone' sign is not required on cross streets or driveways entering the DCZ.



If the DCZ is located in the City's Bilingual Signing Area, as outlined in Section 3.02, the bilingual version of the 'Designated Construction Zone' (MC-1DB) sign must be used (minimum size 900 mm x 900 mm).



b) 'Construction Ends' Sign:

On the roadway under construction, the end of a DCZ must be marked with the 'Construction Ends' (TC-4) sign. If the DCZ is located in the City's Bilingual Signing Area the bilingual version of the 'Construction Ends' (TC-4F) sign must be used (minimum size of 600mm along each side).



c) 'Speed Fines Double' Sign:

At least one 'Speed Fines Double' (MR-179 / MR-179F) sign (minimum size 600 mm x 600 mm) must be placed within a DCZ and be no more than 50 m after the 'Designated Construction Zone' sign which marks the beginning of the DCZ. The 'Speed Fines Double' sign is not required on cross streets or driveways entering the DCZ.

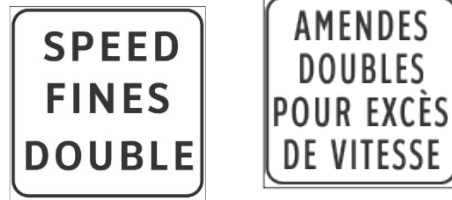

### 3.05 Speed Control and Reduced Speed Limits

#### Prohibited Use of 'MAXIMUM 60 WHEN PASSING WORKERS' Sign

In the past, Construction Agencies commonly used the 'MAXIMUM 60 WHEN PASSING WORKERS' sign to inform drivers to reduce their speed as per Section 3.02.B2 of the 2011 Manual of Temporary Traffic Control. This sign, and any similar sign that links a speed reduction to the presence or absence of workers/equipment, is now **prohibited** from use on all highways throughout Manitoba, including all City of Winnipeg streets.



With the prohibition of the 'MAXIMUM 60 WHEN PASSING WORKERS' sign there are currently three options in The City of Winnipeg available to explicitly control speeds in construction zones:

- Full Time Reduced Speed Limits with or without DCZs
- Daily Shift Reduced Speed Limits with DCZs
- Flagpersons equipped with 'SLOW' paddles

Any posted reduction in speed limit in a construction zone, both full time and daily shift, must be approved and authorized via work order by the Traffic Management Branch and subsequently installed by the Traffic Services Branch.

*Note: For work zones without a posted speed limit reduction but where photo enforcement of the posted speed limit is desired, a 'Construction Ends' (TC-4) sign must be placed at the end of the work zone as per Section 11(1)(b) of Manitoba Regulation 220/2002.*

If a construction agency desires a posted reduction in speed, the *Designated Construction Zone and/or Speed Limit Reduction Request Form* must be submitted to the Traffic Management Branch at least **2 weeks** prior to the requested implementation date. If approved, the Traffic Management Branch will issue a work order to authorize a reduced speed limit as per the March 19, 2008 Council approval delegating authority to the Director of Public Works to set speed limits in construction zones.

### **3.05.A Full Time Reduced Speed Limits**

Full time reduced speed limits, i.e. speed limits reduced to 60 km/h posted 24 hours a day, are generally limited to construction projects with full time lane closures on streets with speed limits of 70, 80 or 90 km/h. Factors considered in determining if a full time reduced speed limit is warranted include:

- Restrictive road geometry resulting from detours, diversions, crossovers or narrow lanes;
- Proximity and exposure of workers to open traffic lanes;
- Proximity of hazards such as pavement edge drop-offs to open traffic lanes;
- Length of construction zone.

### **3.05.B Daily Shift Reduced Speed Limits**

Daily shift reduced speed limits can be used in conjunction with DCZs when full time reduced speed limits are not warranted. The posted reduction in speed limit to 60 km/h is set up and removed daily by the Traffic Services Branch prior to work commencing and after work has been completed for the day. These projects generally do not have full time lane closures or any hazards in the work zone when workers are not present.

### **3.05.C Flagging**

In circumstances where a full time or a daily shift reduced speed limit is not warranted, and there is a desire to control speed through the construction zone, the Construction Agency can employ flagpersons equipped with “SLOW” paddles on the approaches to the work area. Further details on flagging are presented in Section 3.06.

**Designated Construction Zone and/or Speed Limit Reduction Request Form**

<b>Project</b>			
Date Submitted			
Street Name		Posted Speed	
Cross Streets (Start/End)			
Project Duration			
Description of Work			
<b>Applicant</b>			
Company		Name	
Address			
Phone #		Email	
<b>Contractor (if different than above)</b>			
Company		Name	
Address			
Phone #		Email	
<b>Details of Work</b>			
What areas of the street/right-of-way will be affected by the work zone construction area? (travel lane(s), shoulder, sidewalk, median or ditch) Please specify.			
Will the construction area limits change as work progresses? If yes, describe.			
Will temporary traffic control devices be removed at the end of each work day?			
What physical hazards will be present to the motorist when workers are not present?			
What will be the typical hours of work?			
Additional Comments:			
C.O.W. Use ONLY			
Date Received		Response Date	
Comments:			
Work Order No:			

### **3.06 Flagperson Practices**

Flagpersons are used when it is necessary to stop and give a verbal message to approaching motorists or to stop them momentarily. Flagpersons can also be used to signal motorists to reduce speed through a work zone. In all circumstances, the flagperson must be able to communicate effectively. To be effective, the flagperson must be kept aware of the changing conditions in the work zone so that he/she is able to communicate with the motorist respecting:

- a) The road conditions ahead;
- b) The path to follow;
- c) When the potential for interaction between workers and traffic exists; and
- d) When the approach sight distance to the work area is limited.

'FLAGPERSON AHEAD' signs (MC-64) as illustrated in Section 5.02 shall be placed between 90 m and 120 m in advance of the flagperson (see Figure 18) and equipped with flagperson's tools as described in Section 5.02.G. In the majority of work zones, the flagperson shall be stationed 60 m in advance of the work area or start of taper. Flagpersons must always be visible to the motorists for a distance of at least 150 m.

When flagpersons are not present the 'FLAGPERSON AHEAD' sign(s) must be removed or hidden from the motorists' view.

All flagpersons must have completed a Flagperson Training Course and carry with them a training certificate at all times. Training material, including the Flagperson Training Workbook, is available from Manitoba Infrastructure and Transportation. A list of training providers can be found on the Safe Work Manitoba website ([www.safemanitoba.com](http://www.safemanitoba.com)). Furthermore, all flagpersons must adhere to the regulations of the Workplace Safety and Health M.R. 217/2006 and The Highway Traffic Act.

### **3.07 Work Zone Considerations**

#### **3.07.A Lateral and Vertical Position of Traffic Control Devices**

Traffic control devices must be well within the normal field of vision of the motorist to be effective. This is particularly necessary at night when motorists are not able to see the whole roadway environment and must depend upon the reflected light from traffic signs and other devices to provide necessary information. Appropriate lateral and vertical placement of temporary signs helps to ensure that the necessary information is available.

In general, motorists in urban areas travel with their headlights on low beam. Signs and other devices that are placed too low or high, or too far left or right, are not fully reflected. As a result, these types of traffic control devices located on the roadway, boulevard or shoulder should be:

- Between 0.3 m and 2.5 m from the edge of the travel lane;
- The bottom of the sign should be no less than 1.0 m above the roadway; and
- Cleaned regularly.

### **3.07.B Warning Flags**

As illustrated in Section 5.04, warning flags shall be installed on the first warning or temporary traffic control sign in a taper within a long term sign setup and on any portable sign used in a short term sign setup. Use of warning flags increases the visibility of the temporary traffic control devices that define obstructions on the roadway, thereby assisting motorists in selecting the proper traffic lane. Flags shall be:

- Red or orange in colour;
- Shall be no less than 0.16 square metres; and
- Shall be placed so that the top of the flag is a minimum of 0.5 m above the top of the sign.

### **3.07.C Traffic Lane Clearances**

A traffic lane on a major thoroughfare is normally about 3.5 m wide and in no case less than 3.0 m. When traffic lanes are open, these lane widths should remain clear of traffic control devices, construction materials and equipment. Placement of large objects close to the edge of a traffic lane effectively reduces the lane width. Therefore, the placement of material and equipment close to either side of a traffic lane on a major thoroughfare should be avoided wherever possible, particularly on high speed (70, 80 or 90 km/h) routes.

### **3.07.D Construction Equipment**

The location of equipment, material, construction vehicles, and personnel shelters within the work zone must not interfere with the ability of motorists, cyclists and pedestrians to see workers or traffic control devices. The movement of vehicles and equipment into and out of the work zone shall be undertaken with the least possible interference to traffic movements on the street. In many instances, a flagperson will be required for this purpose. Parking of personal vehicles within the work zone is generally not permitted.

## **4.00 MAINTENANCE**

### **4.01 General**

It is the responsibility of the Construction Agency to inspect and undertake the necessary maintenance or replacement of traffic control signs as well as all other devices, and to ensure that they are legible and in their proper place at all times. All signs and devices must be regularly reviewed to ensure that legibility and colour (daytime or nighttime) is approximately equivalent to new devices. For this purpose, reflectorized signs or devices will be deemed to be acceptable if they are clearly visible and legible when illuminated with normal vehicle lights on low beam from a distance of 100 metres. Additionally, their general daytime condition should be such that they command respect. Damaged, defaced or dirty signs lose their authority as traffic control devices, and are a discredit to the Construction Agency responsible for them.

Signs with conflicting messages must be removed from view. Obstructions such as shrubbery, construction materials or parked vehicles, must not obscure the visibility of temporary traffic control devices. **When devices are not required they must either be removed or hidden from the motorists' view.**

#### **4.01.A Work Area Enclosures**

It is the responsibility of the Construction Agency to safely enclose the work area when required, in accordance with the Workplace Safety and Health Regulation 217/2006.

The work area must have a sign prominently identifying the name and emergency telephone number of the Construction Agency.

Construction Agency Name:
Emergency Phone Number:

#### **4.01.B Removal of Traffic Control Devices**

Under Section 77(9) of The Highway Traffic Act, traffic control devices at a construction site must be removed when it is no longer necessary for the devices to remain in place. In some cases, a detour or street closure will be in effect only during certain hours of the day, in which case the affected section of street should be restored to normal use at other times. It is essential that all the devices which are not applicable when the street is restored to normal use be either removed or otherwise hidden from the motorists' view.

### **5.00 TEMPORARY TRAFFIC CONTROL DEVICES AND ILLUSTRATIONS**

#### **5.01 General**

The following sections detail the approved signs and devices required to implement the requirements of this Manual. Figures 1 through 38 in Section 5.04 show typical traffic control details for many circumstances. Adjustments to traffic control may be required to suit site specific conditions.

To be effective during hours of darkness, all signs, barricades, delineators, cones and other similar devices must be reflective. To optimize this reflectivity, these devices must be regularly cleaned and well maintained. As of January 1, 2012 all retroreflective sheeting on temporary traffic signs, barricades and devices must use a minimum Type VIII retroreflective sheeting (ASTM D4956).

Under no circumstances are signs with hand painted lettering, diagrams, or symbols permitted. The use of non-approved signs is an illegal violation of the City's Streets By-Law 1481/77 and Traffic By-Law 1573/77, and is subject to prescribed fines.

#### **5.02 Traffic Control Devices**

This section describes the most commonly used traffic control devices for road work operations and other temporary conditions.



5.02.A Warning, Regulatory and Information Signs



TC-2  
ROADWORK



TC-3  
SURVEY CREW



MC-64  
TRAFFIC CONTROL PERSON AHEAD  
(MINIMUM 900mm X 900mm)



TC-5R  
TEMPORARY LANE CLOSED AHEAD  
(RIGHT VERSION)



TC-13R  
ROAD DIVERSION  
(RIGHT VERSION)

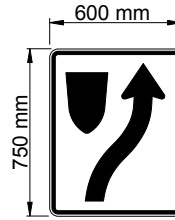

RB-25  
KEEP RIGHT

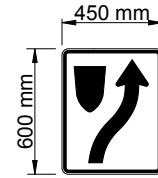

RB-25  
KEEP RIGHT  
REDUCED SIZE



TC-15R  
ROAD REALIGNMENT  
(RIGHT VERSION)



TC-16R  
LANE REALIGNMENT  
(RIGHT VERSION)



WD-A17  
DOUBLE ARROW



WD-A17  
DOUBLE ARROW  
REDUCED WIDTH



WD-A17R  
DOUBLE ARROW  
WITH RIGHT TURN LANE

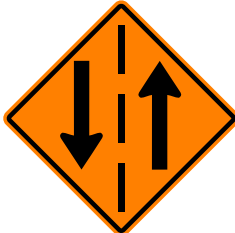

TC-24  
TWO WAY  
TRAFFIC AHEAD



TC-54R  
TRUCK ENTRANCE  
(RIGHT VERSION)



TC-62  
CONSTRUCTION  
MARKER

NOTE:

- Diamond shaped warning signs shall be 750mm x 750mm reflectorized orange unless otherwise specified.
- Reduced size signs are only permitted when the sign is placed on a lane line marking and traffic is allowed to operate on the adjoining traffic lanes.
- Signs which are larger than the minimum sizes specified in Section 5.02 and 5.03 may be desirable to increase conspicuity of the work area and enhance safety of workers.



MC-1 D  
DESIGNATED  
CONSTRUCTION ZONE  
(MIN. 900mm X 900mm)



MC-1 DB  
DESIGNATED  
CONSTRUCTION ZONE  
(MIN. 900mm X 900mm)



TC-4  
CONSTRUCTION ENDS



TC-4DB  
CONSTRUCTION ENDS



MC-33  
EXCAVATION (BILINGUAL)



TC-47  
GROOVED PAVEMENT



ROAD CLOSED



NO EXIT TAB

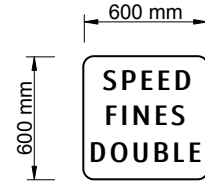

MR-179  
SPEED FINES  
DOUBLE

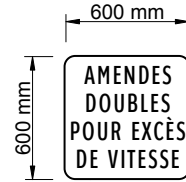

MR-179F  
SPEED FINES  
DOUBLE



TC-49  
PAVEMENT DROP-OFF



TC-51  
BUMP



WD-A65  
FRESH OIL



WD-A69  
LOOSE GRAVEL

NOTE:

- Tabs shall be 300mm x 600mm reflectorized orange or white.
- Diamond shaped warning signs shall be 750mm x 750mm reflectorized orange unless specified otherwise.
- Signs which are larger than the minimum sizes specified in Section 5.02 and 5.03 may be desirable to increase conspicuity of the work area and enhance safety of workers.



TC-73  
SHARE THE ROAD



TC-73S  
SHARE THE ROAD



TC-73SF  
SHARE THE ROAD



TC-17  
YIELD TO  
ONCOMING TRAFFIC



TC-17F  
YIELD TO  
ONCOMING TRAFFIC

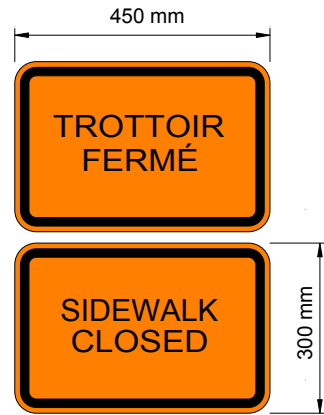

SIDEWALK CLOSED

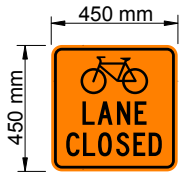

TC-68  
BIKE LANE  
CLOSED



TC-68F  
BIKE LANE  
CLOSED



TC-70  
BIKE DETOUR



TC-70R2F  
(RIGHT VERSION)



TC-70R1F  
(RIGHT VERSION)



TC-71  
BIKE DETOUR  
ENDS



TC-71F  
BIKE DETOUR  
ENDS

**NOTE:**

- Tabs shall be 300mm x 600mm reflectorized orange or white.
- Bike Lane signs are to be 450mm x 450mm reflectorized orange.
- Signs which are larger than the minimum sizes specified in Section 5.02 and 5.03 may be desirable to increase conspicuity of the work area and enhance safety of workers.

**5.02.B Barrels, Cones, Markers and Panels**

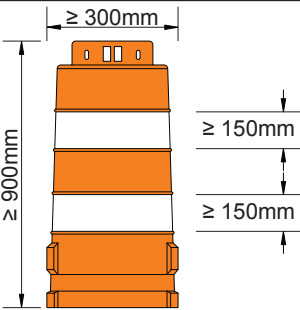
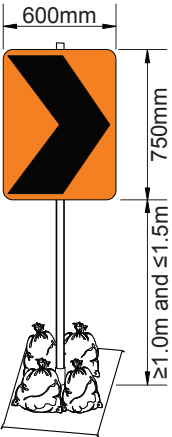
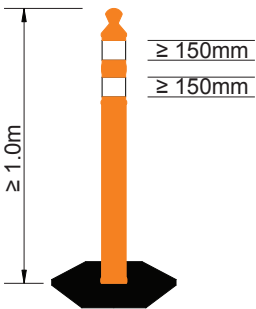
Device & Uses	Illustration	Description
<p>Channelization Barrel TC-63</p> <ul style="list-style-type: none"> <li>• Tapers</li> <li>• Along work areas</li> </ul>		<p>Barrels may be used in tapers and along work areas in place of construction markers, where channelization devices will remain in place for prolonged periods of time.</p>
<p>Chevron TC-31</p> <ul style="list-style-type: none"> <li>• Tapers</li> </ul>		<p>The Chevron sign may be used in place of channelization barrels in tapers, however channelization barrels are preferred.</p>
<p>Tall Cone</p> <ul style="list-style-type: none"> <li>• Along work areas</li> <li>• Lane delineation</li> </ul>		<p>Tall Cones may be used to delineate traffic space alongside the work area in place of construction markers and traffic cones only. Tall cones are not to be used in tapers.</p> <p>The base should weigh a minimum of 5kgs.</p>

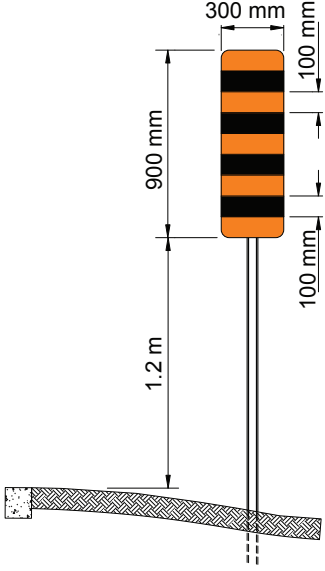
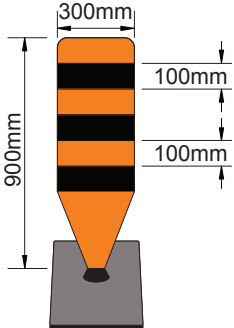
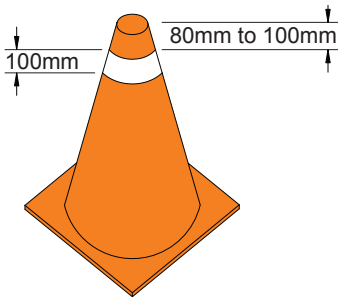
<p>Construction Marker TC-62</p>		<p>Construction markers may be used as a delineation device for high-speed/high-volume work zones in place of tall cones and barrels (barrels are preferred). Construction markers are not to be used to channelize traffic through tapers.</p>	
<ul style="list-style-type: none"> <li>• Along work areas</li> <li>• Lane delineation</li> </ul>	<p>Construction Panel</p>		<p>Construction panels may be used as a delineation device for high-speed/high-volume work zones in place of tall cones and barrels (barrels are preferred). Construction panels are not to be used to channelize traffic through tapers.</p>
<p>Traffic Cone TC-61</p>		<p>Traffic Cones <math>\geq 700</math> mm in height may be used as a delineation device for short term lane closures.</p> <p>The use of smaller traffic cones (not less than 450 mm in height) may be used for a special event (i.e. parade, marathon) where delineation of traffic is required. These cones may only be used during daylight hours.</p>	
<ul style="list-style-type: none"> <li>• Lane delineation</li> </ul>			

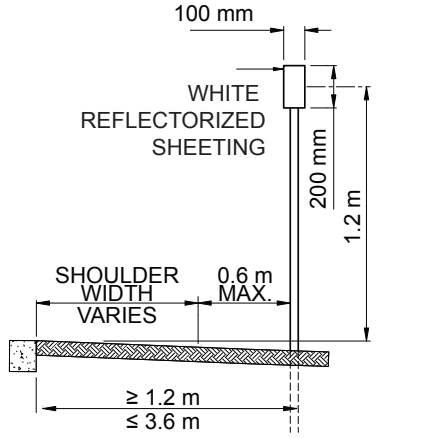
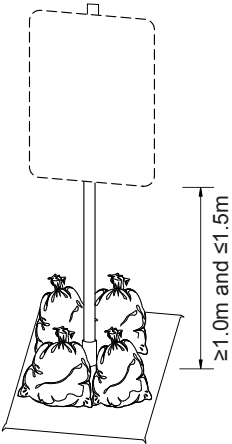
<p>Road Edge Delineator</p>		<p>Road edge delineators may be used to identify the edge of the usable roadway for motorists. Where diversions or detours are undertaken on streets where artificial street lighting is not available or with low levels of street lighting, delineators must be used.</p>
<p>Portable Sign Support</p> <ul style="list-style-type: none"> <li>• To advise of temporary roadway conditions for short term projects and maintenance operations.</li> </ul>		<p>Portable signs shall be stabilized with a minimum of 4 sandbags or other suitable counterweight. The supports may be weighted bases or folding frames, provided that the signs are held securely and maintained in proper position. Portable signs with round bases (i.e. tire rims) are illegal and are not permitted for use on City streets.</p>

### 5.02.C Flashing or Sequential Arrow Traffic Control Devices (Arrow Boards)

Construction Agencies are encouraged to use arrow boards to increase the visibility of a work zone. Arrow boards are specifically required for short term work at night and for mobile and very short duration work zones at night and on streets with a speed limit of 70, 80 or 90 km/h. However, arrow boards are also recommended for short term work on streets with a speed limit of 70, 80 or 90 km/h and as a supplement in any circumstance that requires higher than normal visibility (nighttime, high speed, high traffic volumes).

Requirements for the arrow board devices are as follows.

1. Arrow boards shall be mounted on a vehicle or on a trailer so that they are clearly visible from the rear. The bottom edge of the device shall be a minimum of 1.5 m from ground level.
2. The arrow board message should be distinguishable by an approaching motorist at a distance of at least 500 m on a sunny day.
3. The visibility of the arrow board to approaching motorists must not be obscured by any other devices or objects on the vehicle upon which the arrow board is mounted.

4. Arrow boards should be dimmer for nighttime applications compared to daytime applications so they do not impair the vision of approaching motorists.

5. The device may operate in one of the following modes: i) Left Arrow, ii) Right Arrow, iii) Both Arrows Heads (no shaft), or iv) Horizontal Warning Bar (light stick). The on/off is the preferred mode of operation; however, sequential arrow (Bar/Arrow head and Bar/Off) is also acceptable. The standard warning mode is for all lights on the bar (or shaft) to flash on and off.

*Note: the use of a horizontal warning bar (light stick) is not an acceptable form of temporary traffic control on a Regional Street, unless used in a parking lane where the speed is 60 km/h or less.*

Figures in the short term, mobile and very short duration work zones sections illustrate the use of an arrow board.

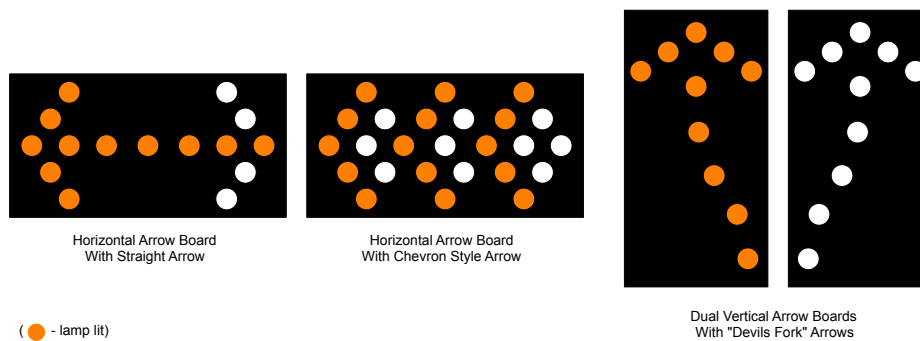

#### **5.02.D Variable Message Signs**

Variable message signs (VMS) are generally used to warn motorists in advance of and during a project when significant traffic impacts are expected. VMS are often used for full closures, detours and significant lane closures on high volume routes. The use of VMS and the message displayed is to be specified by the Traffic Management Branch in consultation with the Traffic Services Branch. When VMS are unavailable, static information signs may be posted by the Traffic Services Branch as an alternative.

#### **5.02.E Barricades**

Barricades may be used in situations where it is necessary to close a road, street, lane or shoulder at, or in advance of, the work area; barricades are then placed at the start of, and end of the work zone. The enclosure of the work zone using barricades must ensure that motorists, cyclists and pedestrians are adequately advised of the boundaries of the work zone. When barricades are removed to allow access/egress from the work zone for vehicles or equipment, the barricades shall be replaced immediately after such access/egress has occurred. The use of barricades to form a wall alongside the work area (parallel with traffic flow) is strictly prohibited except in the case of curb repair work.

The placement of barricades shall generally be in the manner indicated in the “Illustrations of Typical Situations” in Section 5.04.

## Device Requirements

As of January 2012, all sides must have a minimum type VIII (high intensity) retroreflective sheeting and the barricade panel identified with ("W" x "X") shall be vertically striped in accordance with the M.U.T.C.D.C (Part D – Temporary Conditions).

The Agency's name and telephone number **MUST** be clearly displayed on the barricade panel in the bottom right corner (maximum size 450 mm wide and 120 mm high).

Barricades must conform to the following specifications:

### 1) Reflectorized Light Barricade

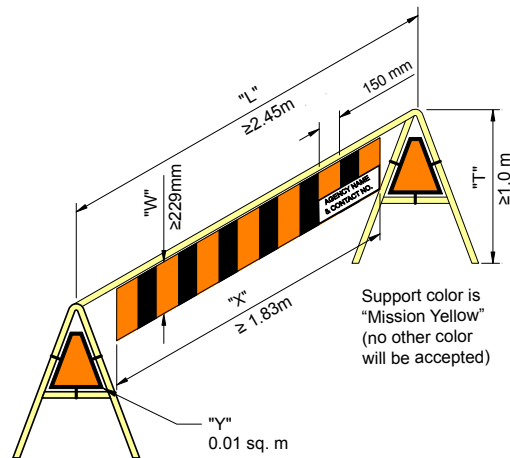

### 2) Reflectorized Concrete Barricade

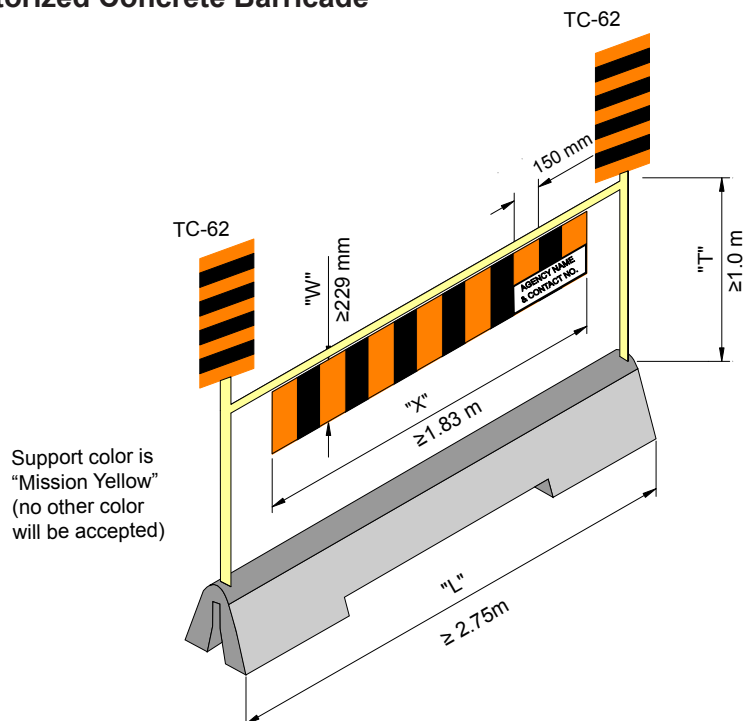



### 3) Sidewalk Manhole Barricade

The sidewalk manhole barricade is used to provide safety and protection when work is to be performed around manholes. The Construction Agency is responsible for ensuring that the use of the barricades is in accordance with the Manitoba Workplace Safety and Health Regulation and conforms to the necessary safety standards and specifications for sidewalk manhole barricades.

#### 5.02.F Barriers

Barriers, commonly referred to as jersey barriers, are used to separate traffic lanes, re-route traffic and/or protect workers and pedestrians during construction. The placement of barriers must be parallel to the flow of traffic continuously without gaps. Leaving barrier ends exposed creates a hazard for errant motorists and must be avoided or protected. Barriers may either be tapered such that barrier ends are located outside the roadway clear zone or be adequately protected with an appropriate form of end treatment described below minimizing any potential hazard.

Barriers must conform to the following specifications:

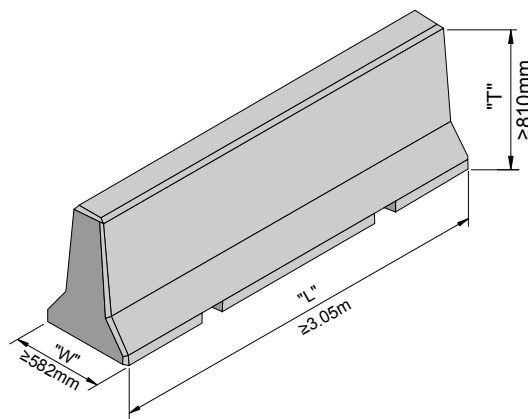

#### Reflectorized Impact Recovery System Devices (End Treatments)

Placement and selection of end treatments is to be designed by a Professional Engineer using AASHTO Roadside Design Guide, 4<sup>th</sup> Edition. Devices must conform to NCHRP (National Cooperative Highway Research Program) Test Level 3 or MASH (Manual for Assessing Safety Hardware) and must be non-gating and redirective.

### **5.02.G Flagperson's Tools, Road Marking Tape and Snow Fencing**

#### **Flagperson's Tools**

A flagperson must be equipped with applicable tools as outlined in Part 20 of the Workplace Safety and Health Regulation 217/2006.

The dimensions of the flagperson's STOP/SLOW paddle are not to be less than 450 mm x 450 mm with 10 cm lettering as per the M.U.T.C.D.C.

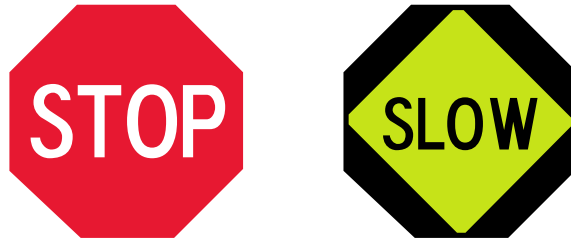

MC-44A

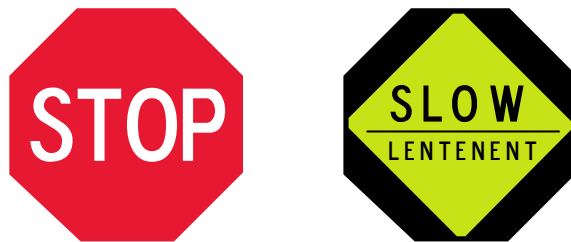

MC-44A B

#### **Reflectorized Road Marking Tape**

Reflectorized road marking tape can be used for short-term pavement markings and should not conflict with permanent pavement markings.

#### **Orange Plastic Snow Fencing**

Orange plastic snow fencing can be installed and maintained on any perimeter side of a construction project site where there is a risk to the safety and health of a person travelling whether by walking or by vehicle immediately adjacent to the site. Orange plastic snow fencing must be a minimum 1 m in height.

**5.03 ILLUSTRATION SYMBOLS**



WARNING SIGN

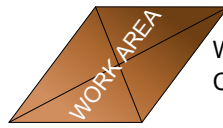

WORK AREA/  
CLOSED AREA



TRAFFIC CONE  
SPACED AT 4.0 m INTERVALS.



CONSTRUCTION  
MARKER



DELINEATOR



DIRECTIONAL REGULATORY SIGN

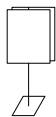

BI- DIRECTIONAL REGULATORY SIGN



REFLECTORIZED BARRICADE



CHEVRON



CHANNELIZATION  
BARREL



FLAGPERSON



TALL CONE



DIRECTION OF TRAVEL  
(PLAN VIEW)



WARNING FLAGS



FLASHING OR SEQUENTIAL  
ARROW TRAFFIC CONTROL DEVICE

# **5.04 ILLUSTRATIONS OF TYPICAL SITUATIONS**

**FIGURE 1a**

**LONG TERM RIGHT LANE CLOSURE ON A MULTI-LANE STREET**

Permanent Posted Speed Limit (km/h)	Distance "A" (m)	Minimum # Channelization Barrels in Taper
50-60	50	5
70-90	100	8 </td

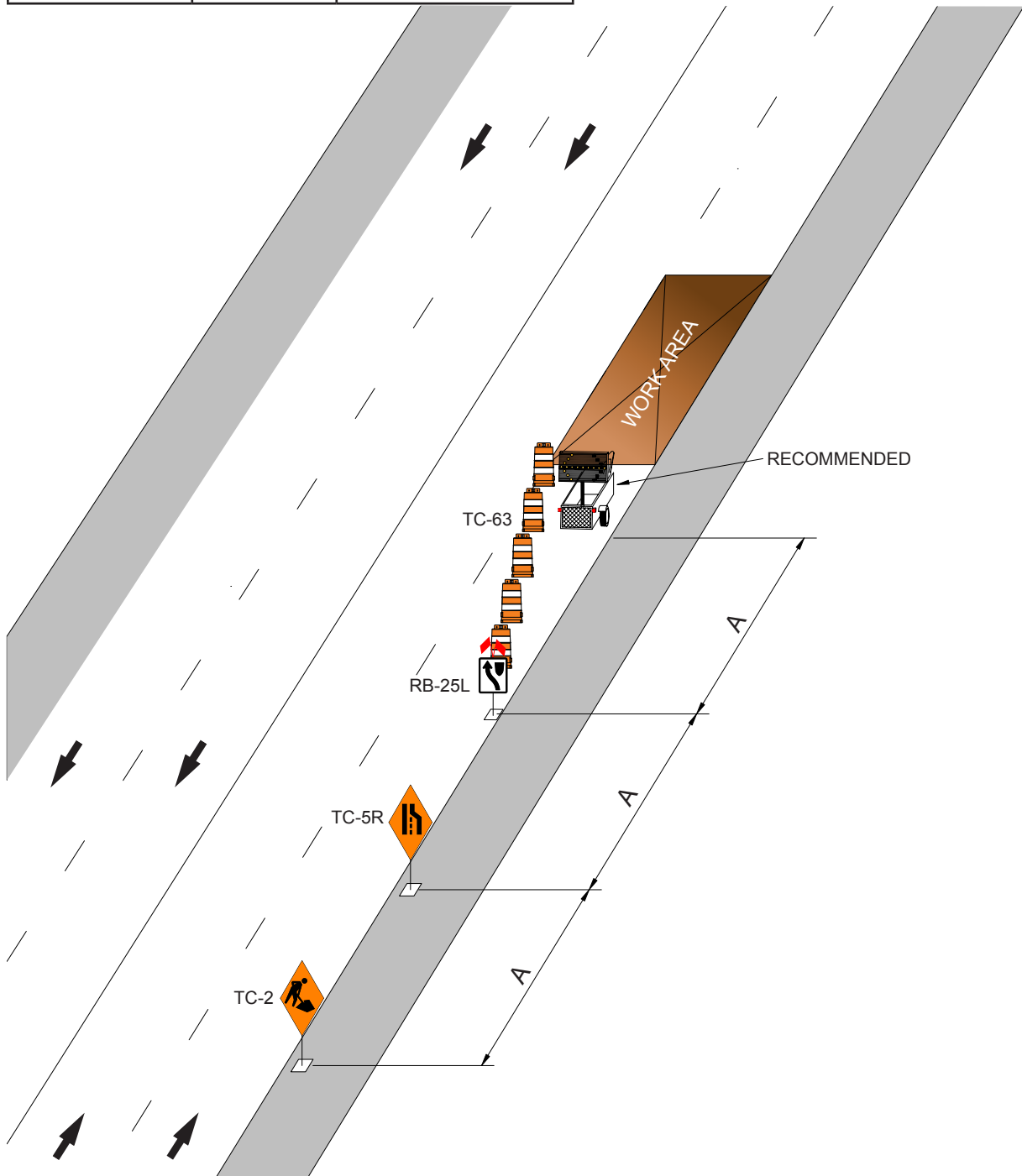

**FIGURE 1b**

**LONG TERM RIGHT LANE CLOSURE ON A MULTI-LANE STREET  
(USING CHEVRONS IN PLACE OF BARRELS)**

Permanent Posted Speed Limit (km/h)	Distance "A" (m)	Minimum # Chevrons in Taper
50-60	50	3
70-90	100	6

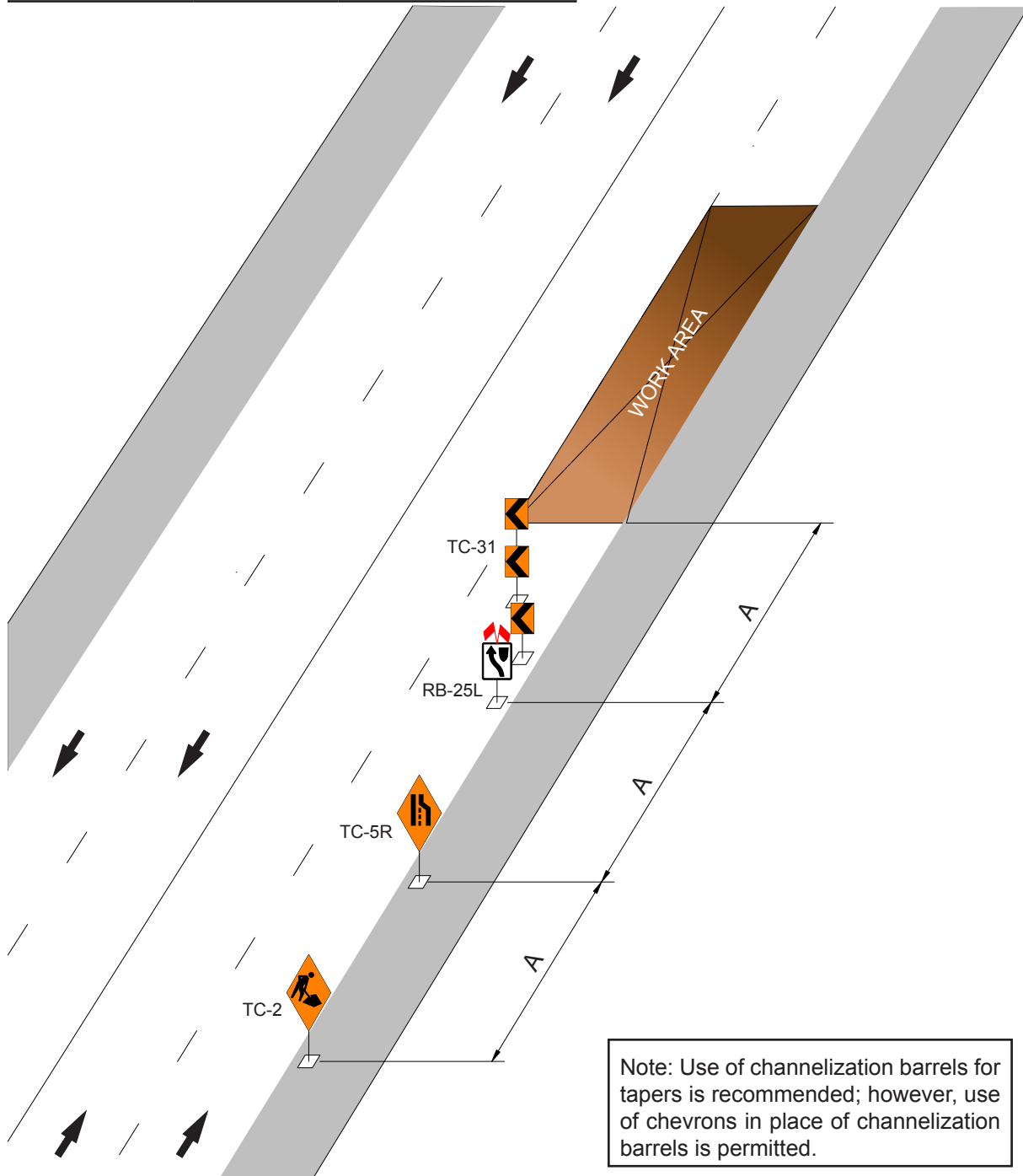

**FIGURE 2**

**LONG TERM RIGHT LANE CLOSURE ON A FOUR LANE UNDIVIDED HIGHWAY  
MAINTAINING TWO LANES IN THE CLOSURE DIRECTION**

**(TWO LANE SHIFT)**

Permanent Posted Speed Limit (km/h)	Distance "A" (m)	Minimum # Channelization Barrels in Taper
50-60	50	5
70-90	100	8

Note: On certain Regional Streets Traffic Management may require daily directional reversing of this setup for peak periods.

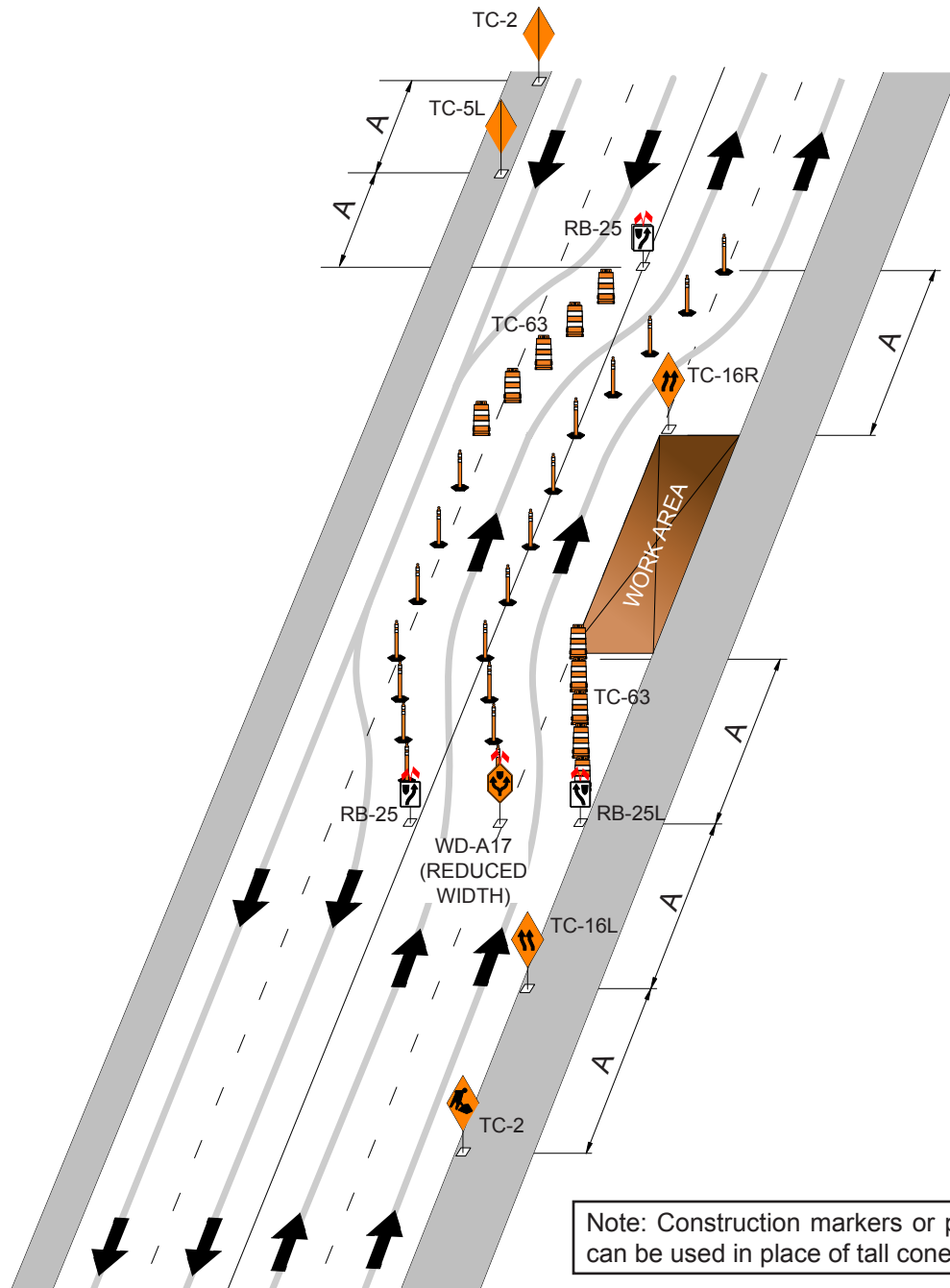

Note: Construction markers or panels can be used in place of tall cones.

**FIGURE 3**

**LONG TERM CLOSURE OF HALF OF A FOUR LANE UNDIVIDED STREET**

Permanent Posted Speed Limit (km/h)	Distance "A" (m)	Minimum # Channelization Barrels in Taper
50-60	50	5
70-90	100	8

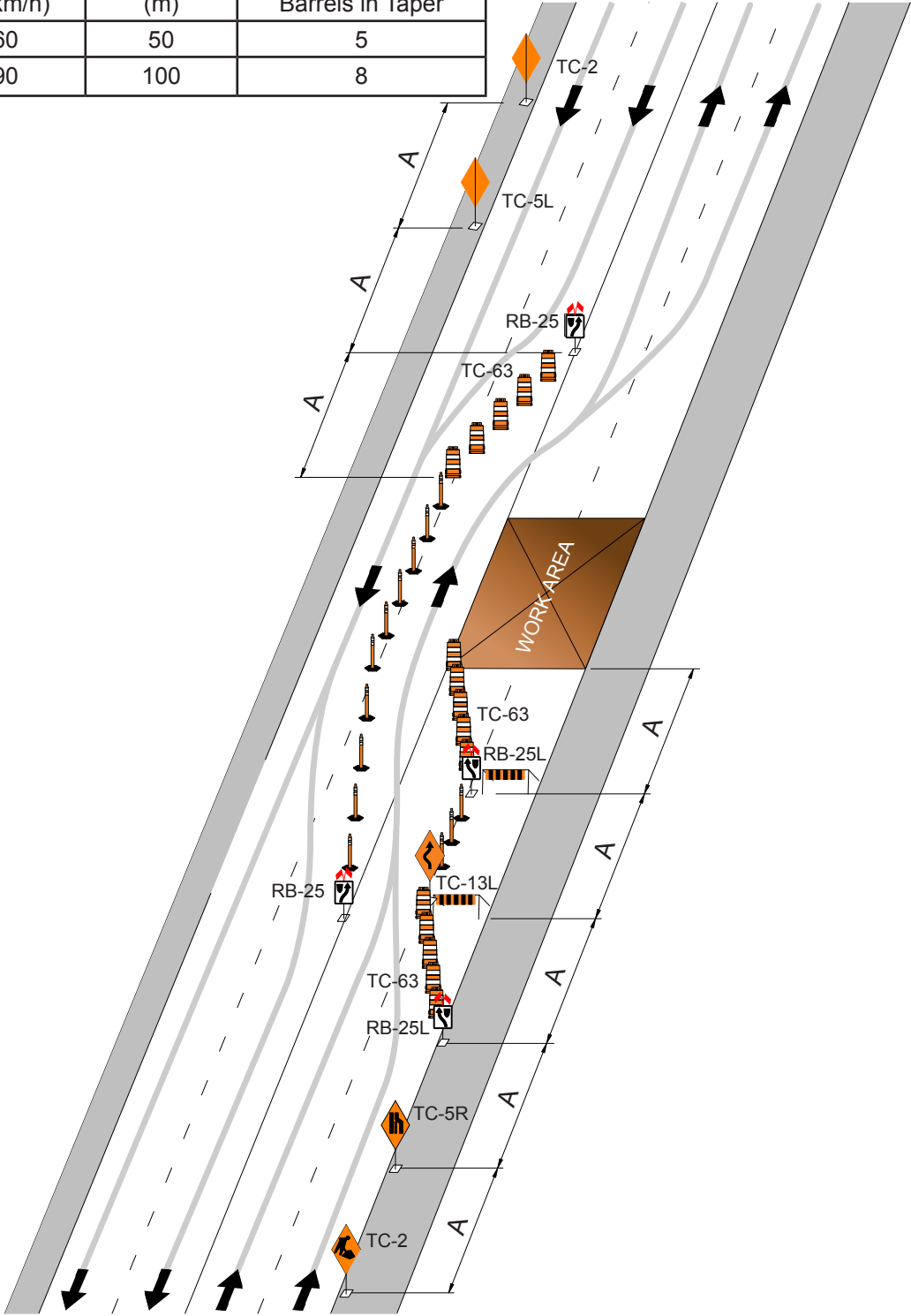
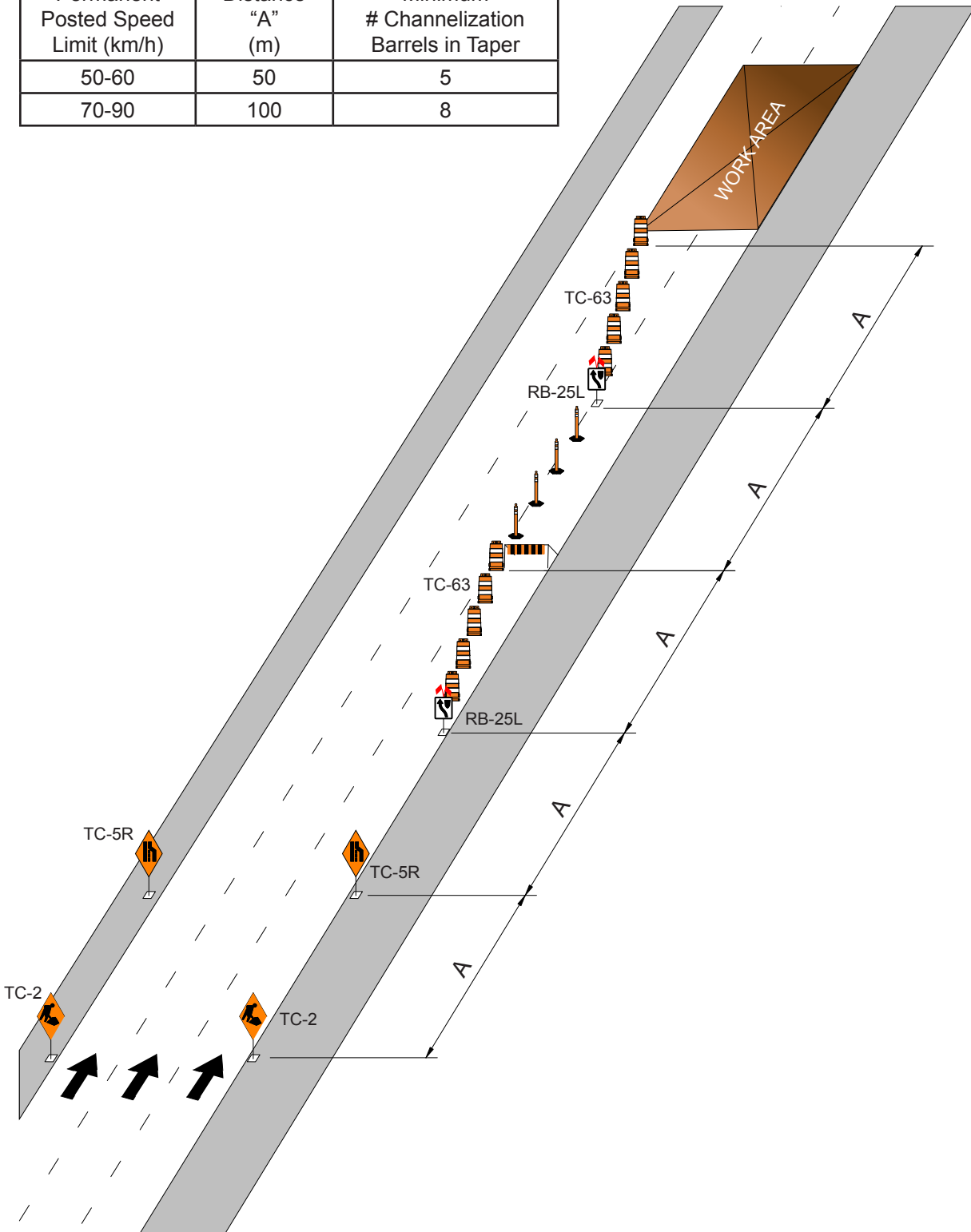



**FIGURE 4**

**LONG TERM CLOSURE OF TWO OUT OF THREE LANES ON A MULTI-LANE STREET**

Permanent Posted Speed Limit (km/h)	Distance "A" (m)	Minimum # Channelization Barrels in Taper
50-60	50	5
70-90	100	8

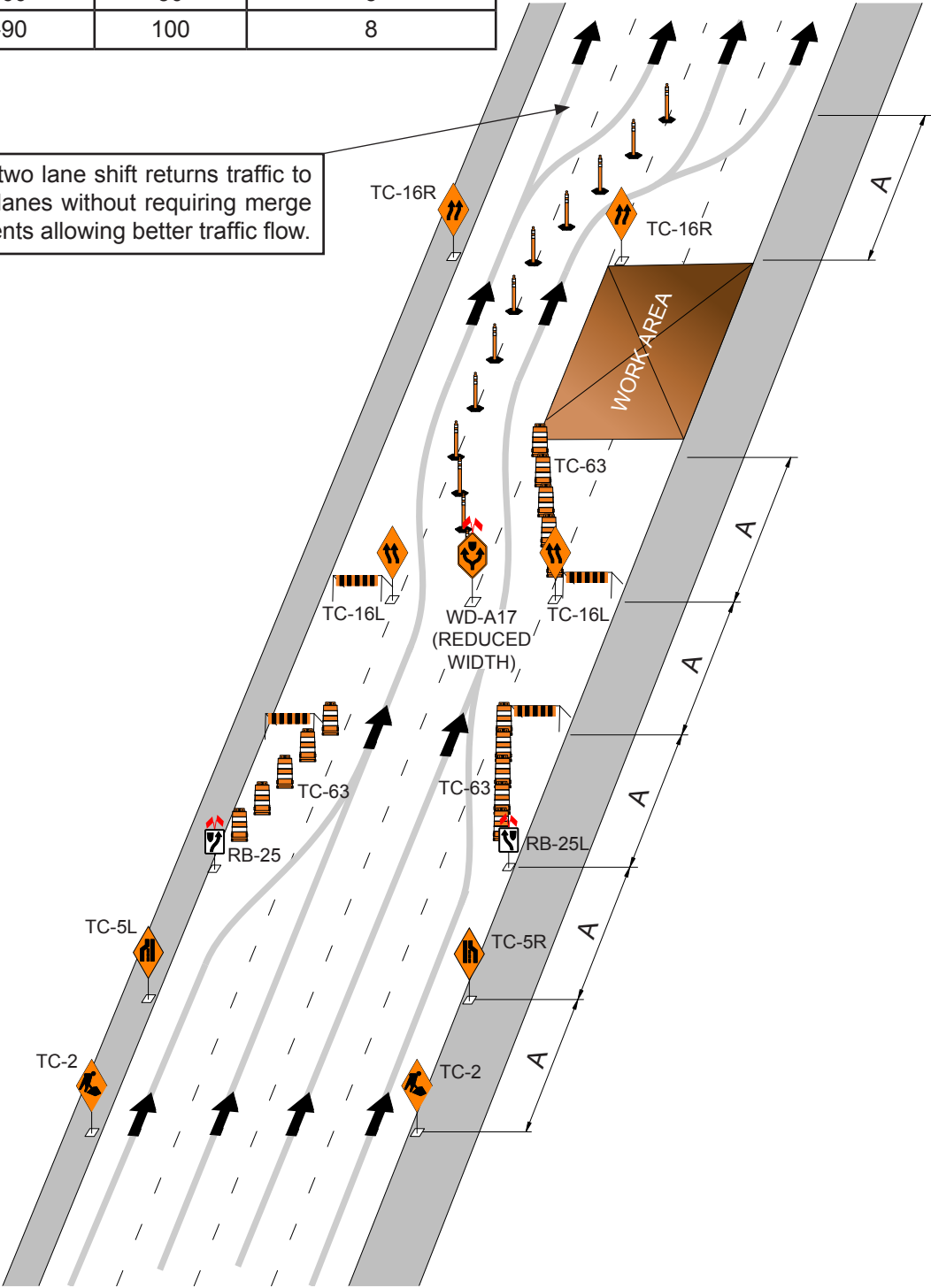

**FIGURE 5**

**LONG TERM CLOSURE OF TWO OUT OF FOUR LANES ON A MULTI-LANE STREET (TWO LANE SHIFT)**

Permanent Posted Speed Limit (km/h)	Distance "A" (m)	Minimum # Channelization Barrels in Taper
50-60	50	5
70-90	100	8

Note: A two lane shift returns traffic to original lanes without requiring merge movements allowing better traffic flow.

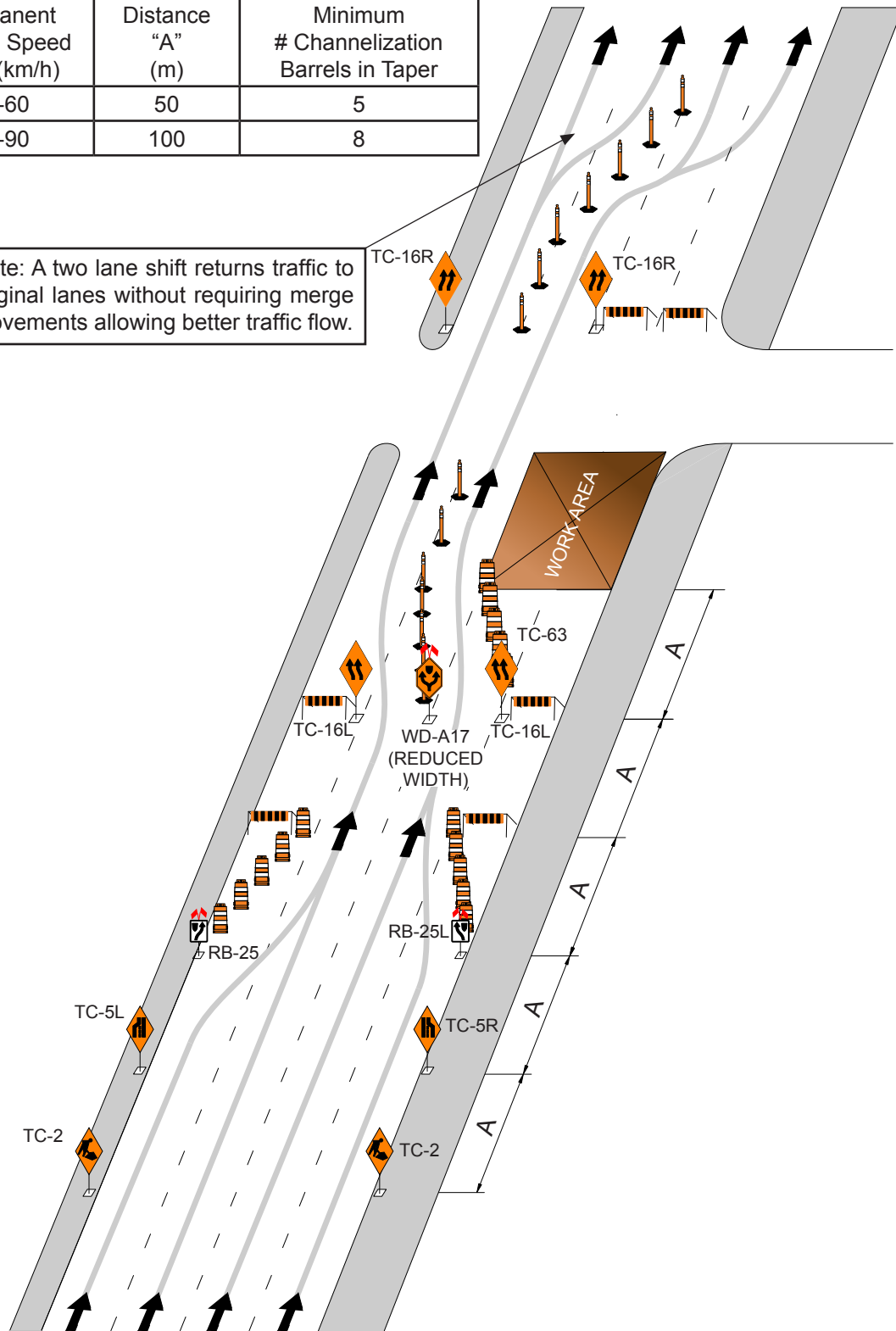

**FIGURE 6**

**LONG TERM CLOSURE OF TWO OUT OF FOUR LANES ON A MULTI-LANE STREET INCLUDING AN INTERSECTION (TWO LANE SHIFT)**

Permanent Posted Speed Limit (km/h)	Distance "A" (m)	Minimum # Channelization Barrels in Taper
50-60	50	5
70-90	100	8

Note: A two lane shift returns traffic to original lanes without requiring merge movements allowing better traffic flow.



**FIGURE 7**

**LONG TERM CLOSURE OF NON-ADJACENT LANES  
ON A MULTI-LANE STREET**

Permanent Posted Speed Limit (km/h)	Distance "A" (m)	Minimum # Channelization Barrels in Taper
50-60	50	5
70-90	100	8

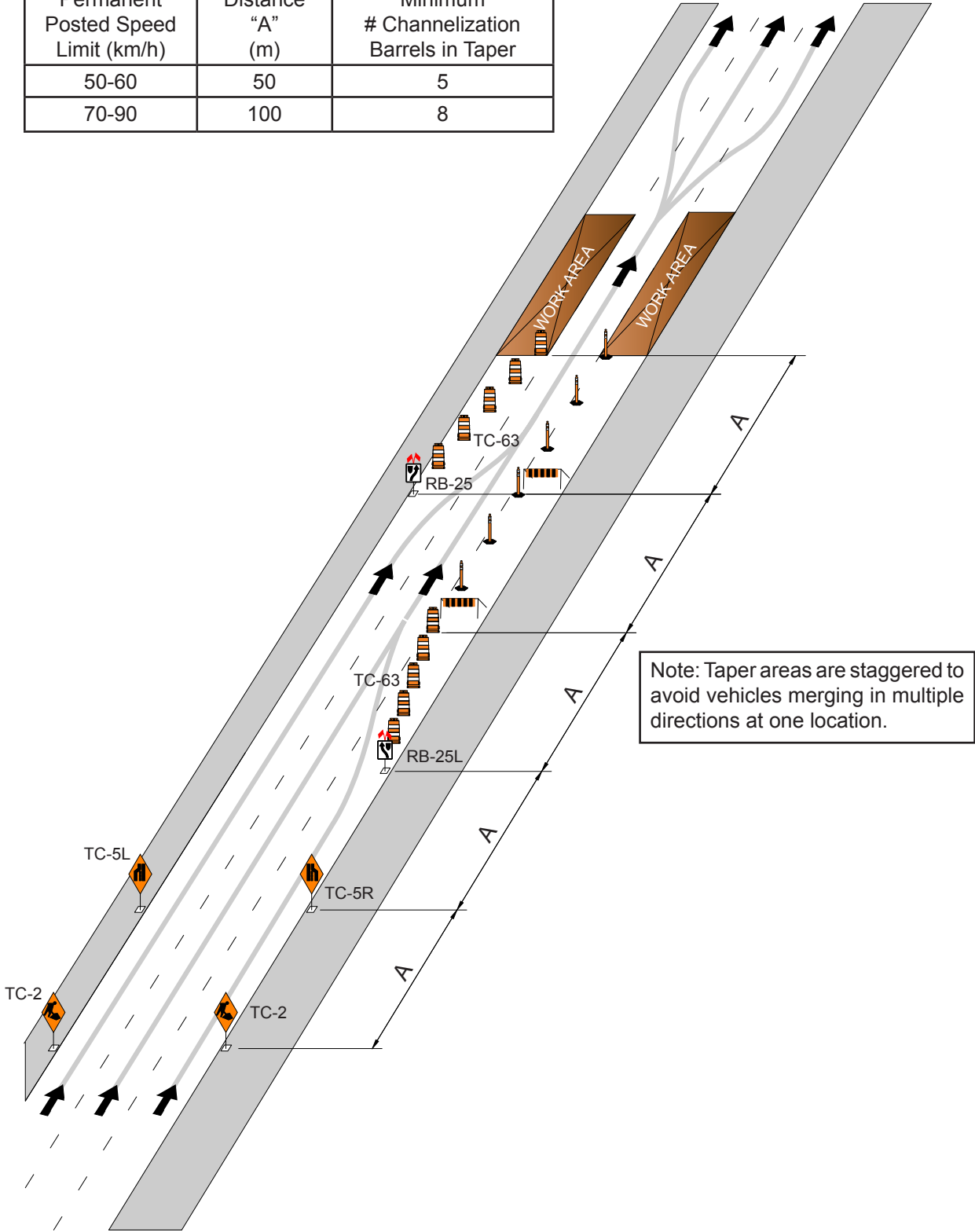

**FIGURE 8**

**LONG TERM CLOSURE OF ONE OUT OF THREE LANES  
ON A MULTI-LANE STREET (TWO LANE SHIFT)**

Permanent Posted Speed Limit (km/h)	Distance "A" (m)	Minimum # Channelization Barrels in Taper
50-60	50	5
70-90	100	8

Note: A two lane shift returns traffic to original lanes without requiring merge movements allowing better traffic flow.

Note: This type of closure can be considered when the right curb lane is used for parking or day-to-day traffic volumes in the curb lane are low. If the curb lane traffic volume is high refer to Figure 9 for traffic control.

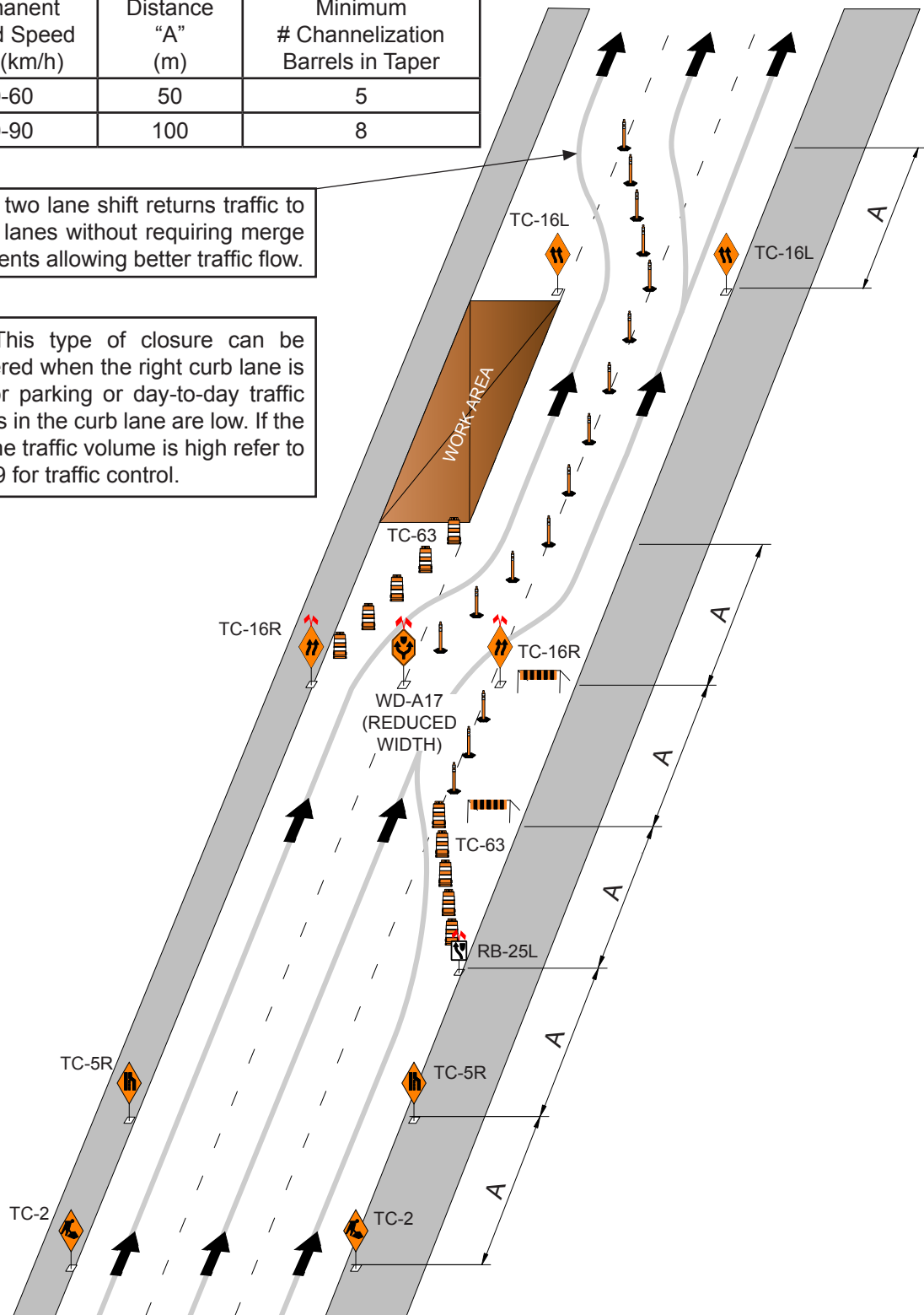
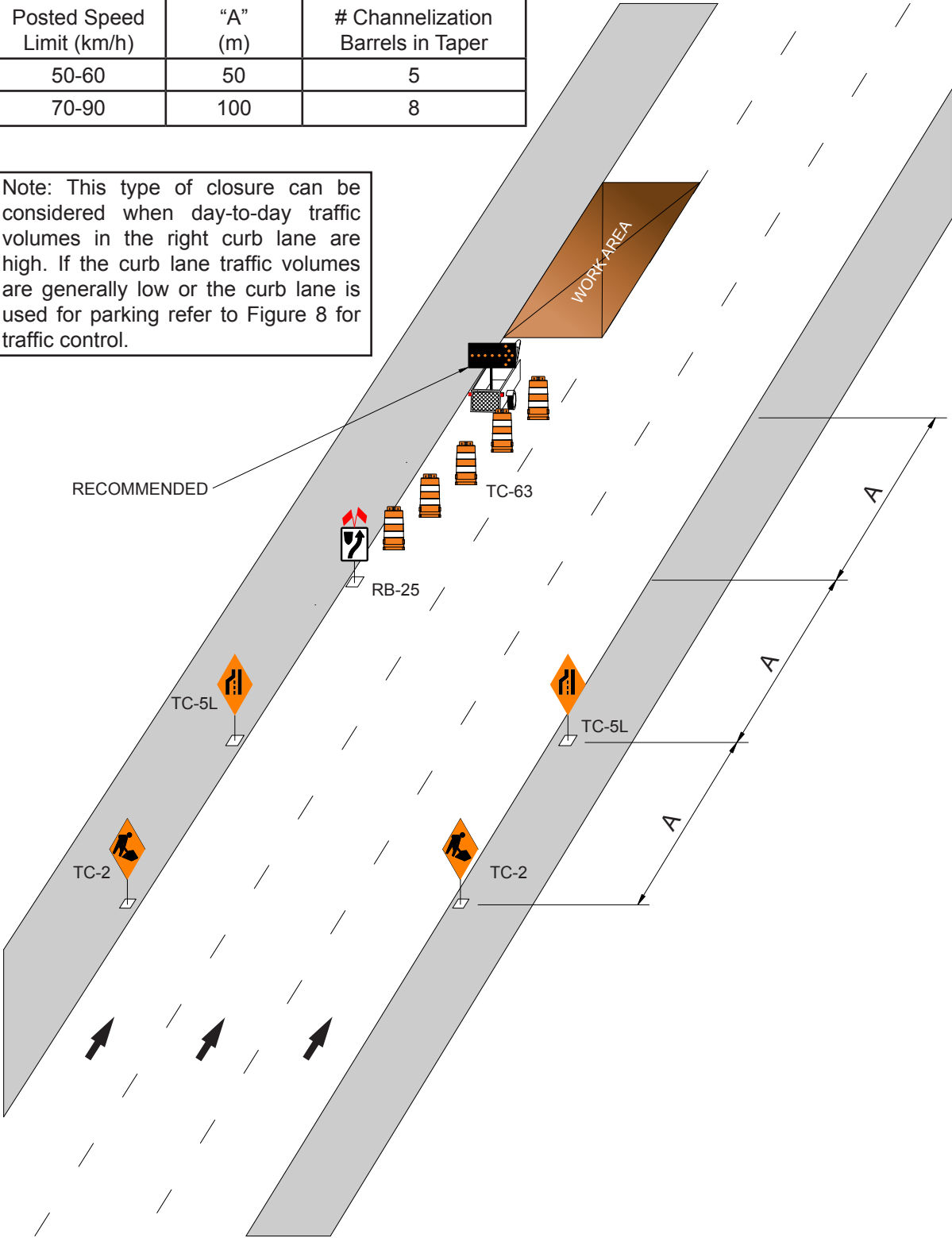

**FIGURE 9**

**LONG TERM CLOSURE OF ONE OUT OF THREE LANES  
ON A MULTI-LANE STREET**

Permanent Posted Speed Limit (km/h)	Distance "A" (m)	Minimum # Channelization Barrels in Taper
50-60	50	5
70-90	100	8

Note: This type of closure can be considered when day-to-day traffic volumes in the right curb lane are high. If the curb lane traffic volumes are generally low or the curb lane is used for parking refer to Figure 8 for traffic control.



**FIGURE 10**

**LONG TERM CLOSURE OF CENTRE LANE OR LANES OF A DIVIDED STREET**

Permanent Posted Speed Limit (km/h)	Distance "A" (m)	Minimum # Channelization Barrels in Taper
50-60	50	5
70-90	100	8

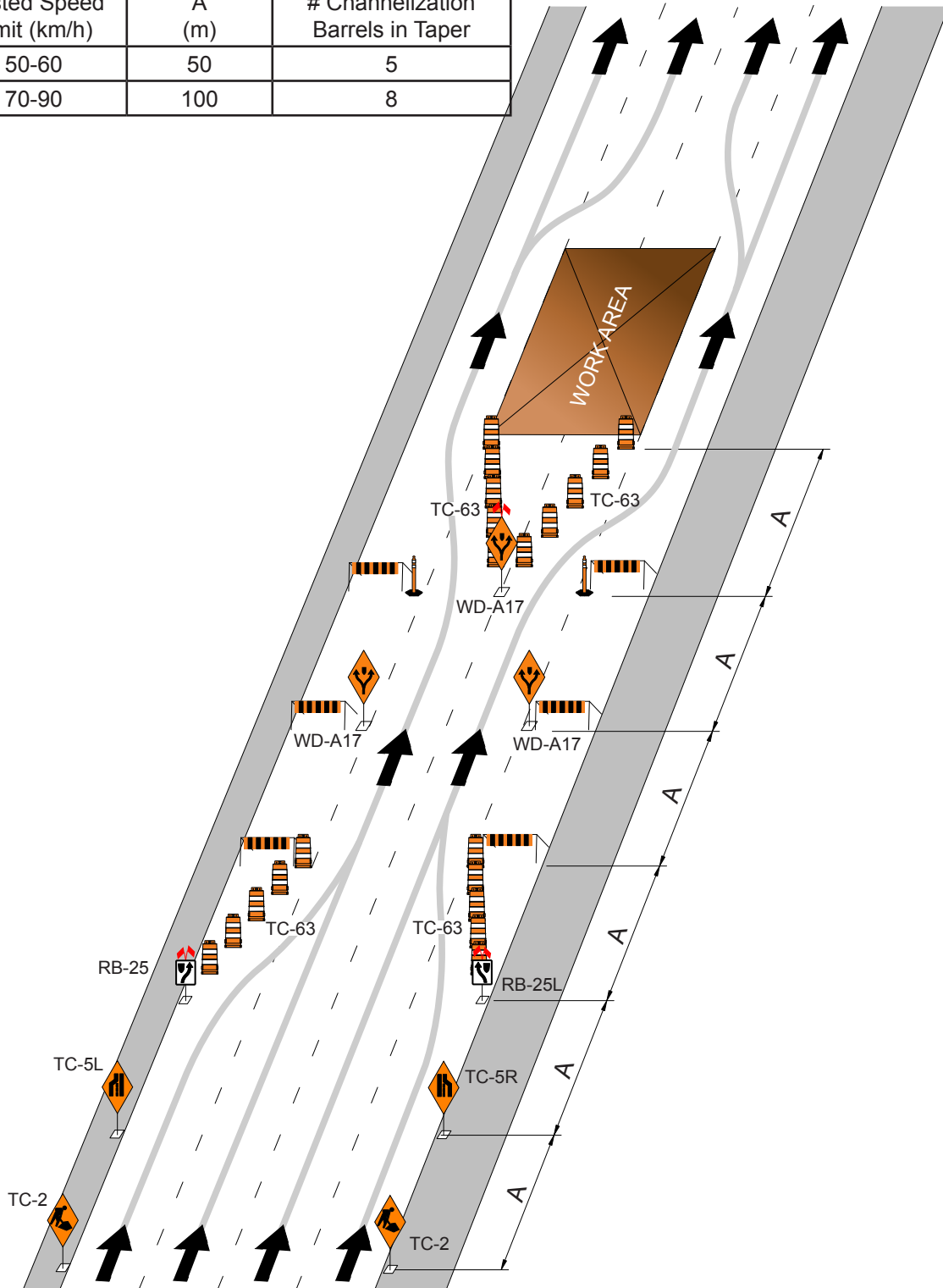

**FIGURE 11**

**LONG TERM CLOSURE OF CENTRE LANE OR LANES  
OF A MULTI-LANE STREET (LEFT TURN LANE ALTERNATIVE)**

Permanent Posted Speed Limit (km/h)	Distance "A" (m)	Minimum # Channelization Barrels in Taper
50-60	50	5
70-90	100	8 </td

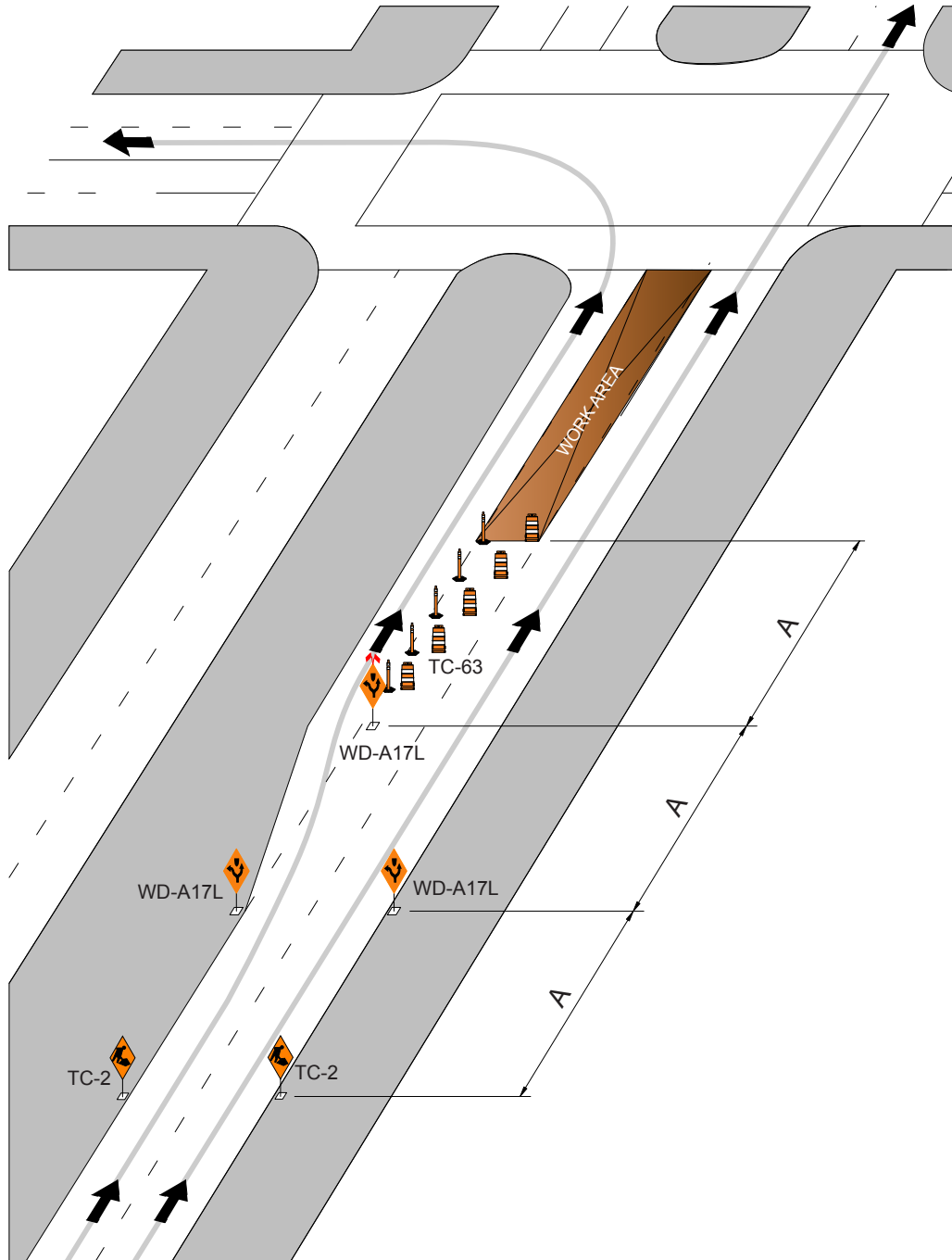
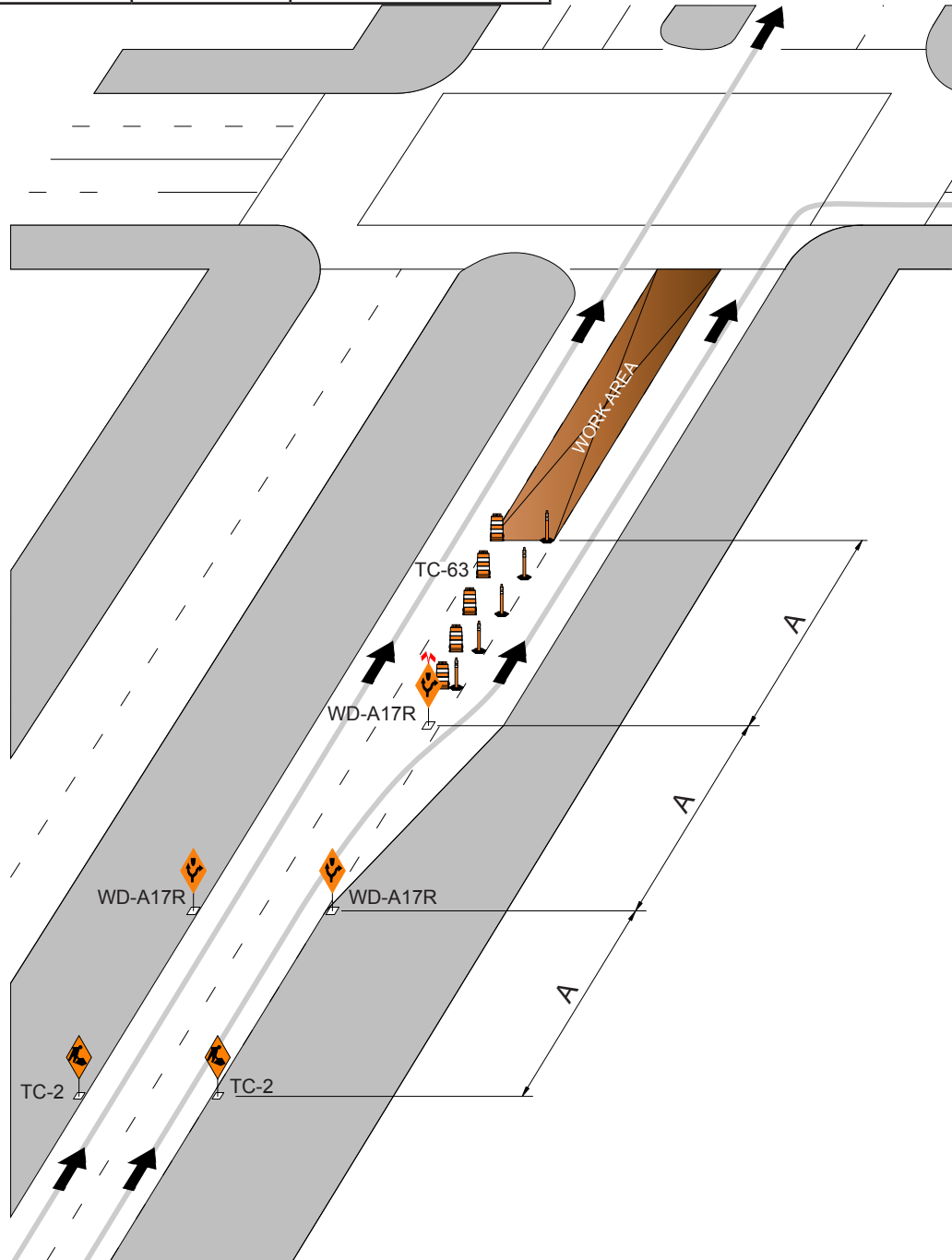



**FIGURE 12**

**LONG TERM CLOSURE OF CENTRE LANE OR LANES  
OF A MULTI-LANE STREET (RIGHT TURN LANE ALTERNATIVE)**

Permanent Posted Speed Limit (km/h)	Distance "A" (m)	Minimum # Channelization Barrels in Taper
50-60	50	5
70-90	100	8



**FIGURE 13**

**LONG TERM CLOSURE ADJACENT TO AN INTERSECTION  
OF A FOUR LANE UNDIVIDED STREET**

Permanent Posted Speed Limit (km/h)	Distance "A" (m)	Minimum # Channelization Barrels in Taper
50-60	50	5
70-90	100	8

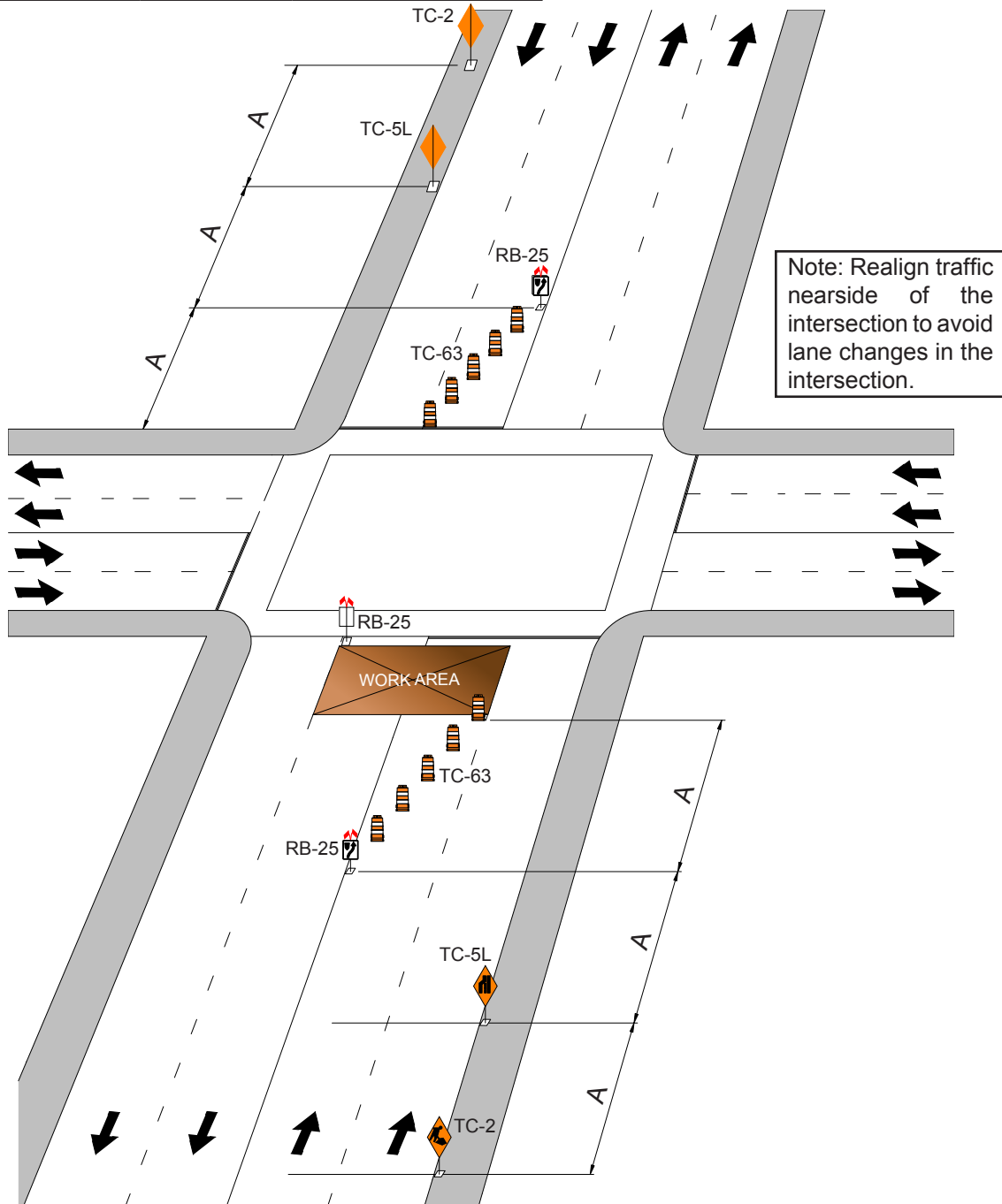

**FIGURE 14**

**LONG TERM CLOSURE WITHIN AN INTERSECTION  
OF A FOUR LANE UNDIVIDED STREET**

Permanent Posted Speed Limit (km/h)	Distance "A" (m)	Minimum # Channelization Barrels in Taper
50-60	50	5
70-90	100	8

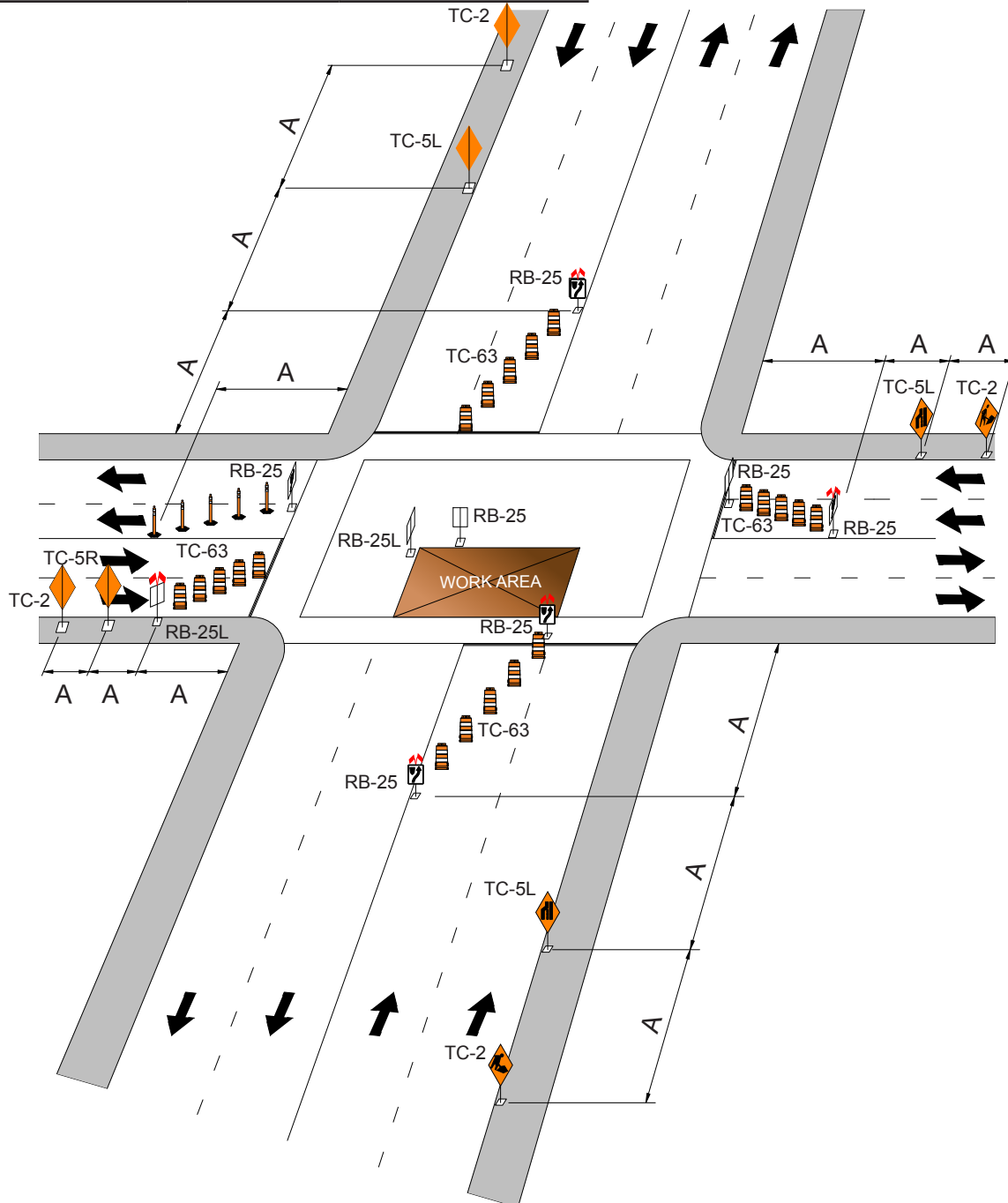

**FIGURE 15**

**LONG TERM CLOSURE ON A HORIZONTAL CURVE**

Permanent Posted Speed Limit (km/h)	Distance "A" (m)	Minimum # Channelization Barrels in Taper
50-60	50	5
70-90	100	8

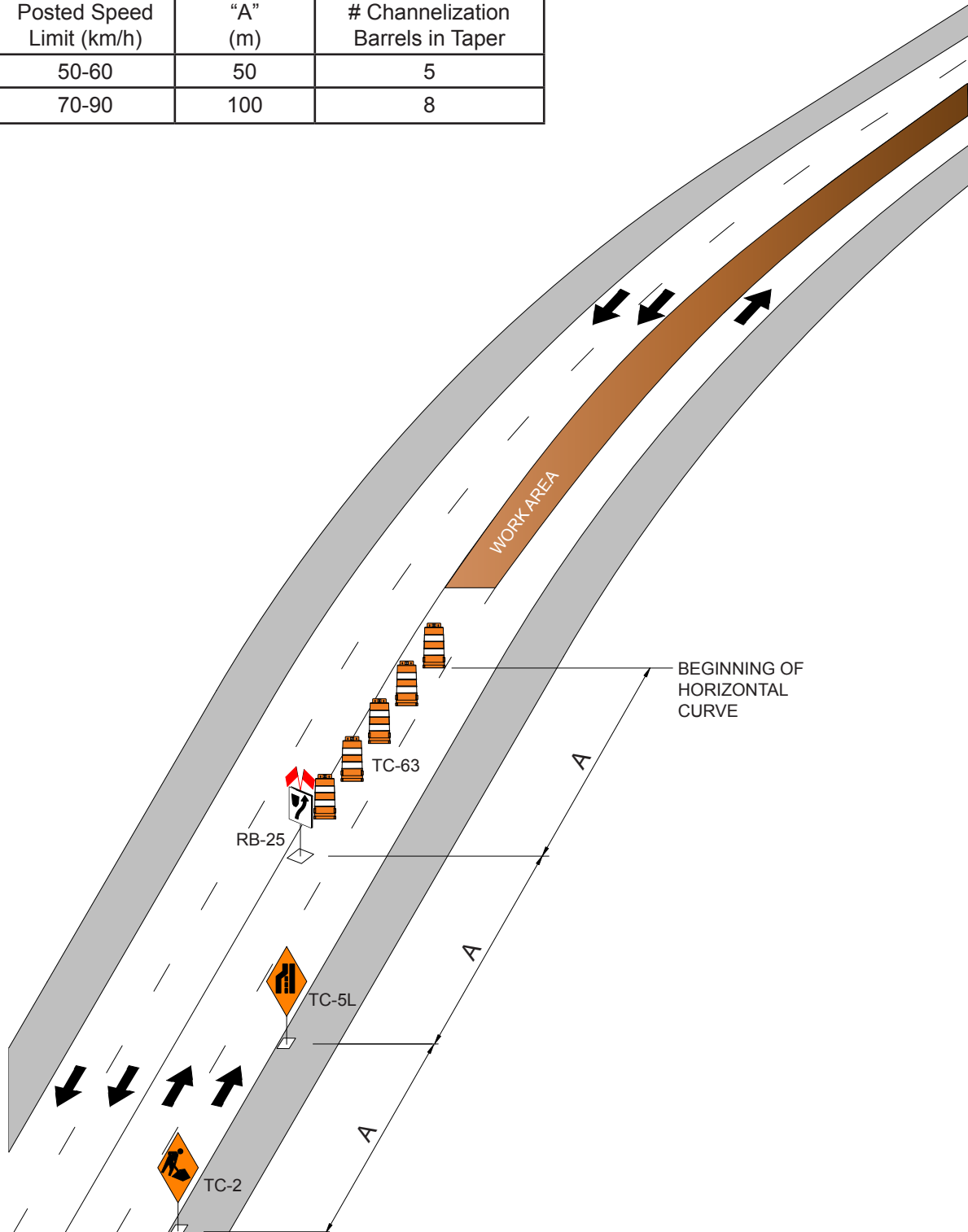

**FIGURE 16**

**LONG TERM CLOSURE ON A VERTICAL CURVE**

Permanent Posted Speed Limit (km/h)	Distance "A" (m)	Minimum # Channelization Barrels in Taper
50-60	50	5
70-90	100	8

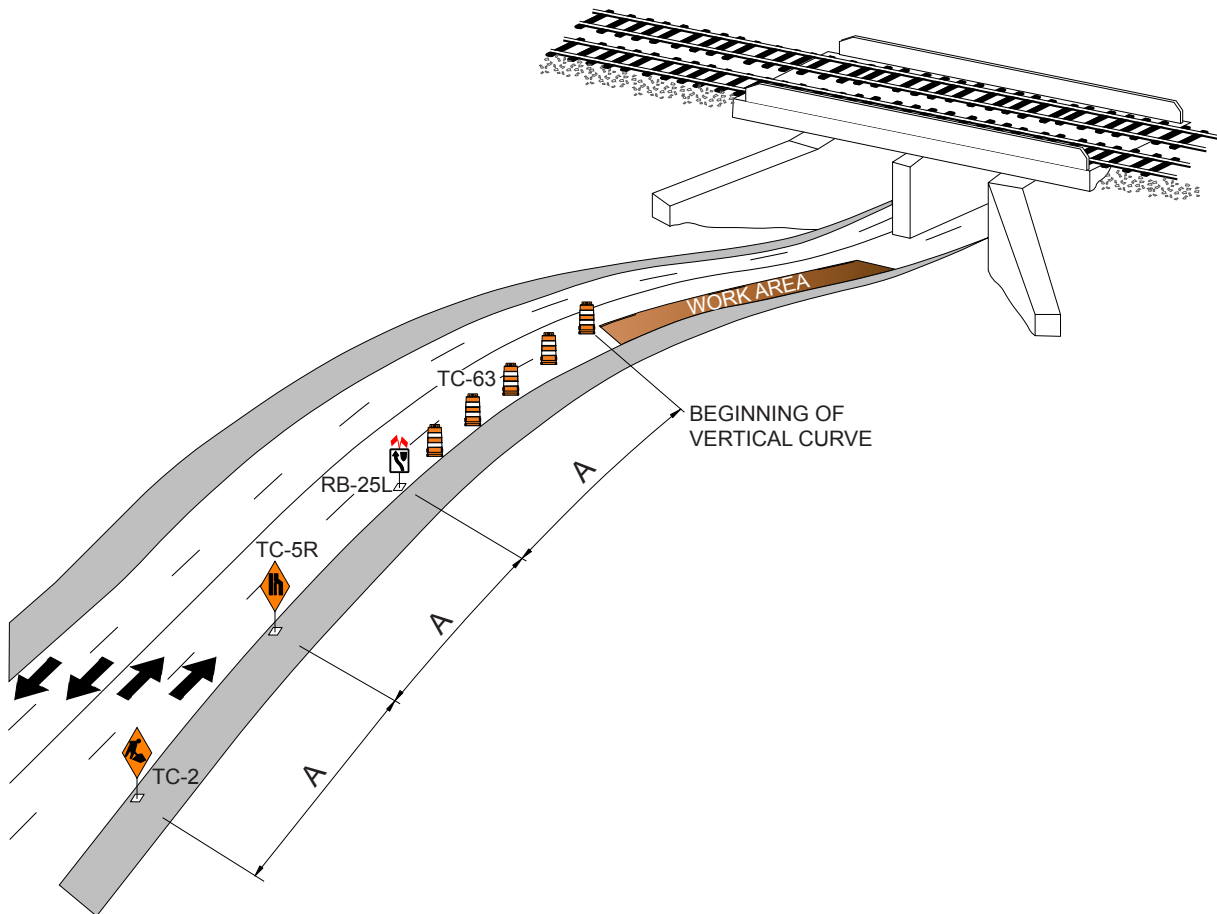

**FIGURE 17**

**LONG TERM DIVERSION AROUND A WORK AREA USING SHOULDER**

Permanent Posted Speed Limit (km/h)	Distance "A" (m)	Minimum # Channelization Barrels in Taper
50-60	50	5
70-90	100	8

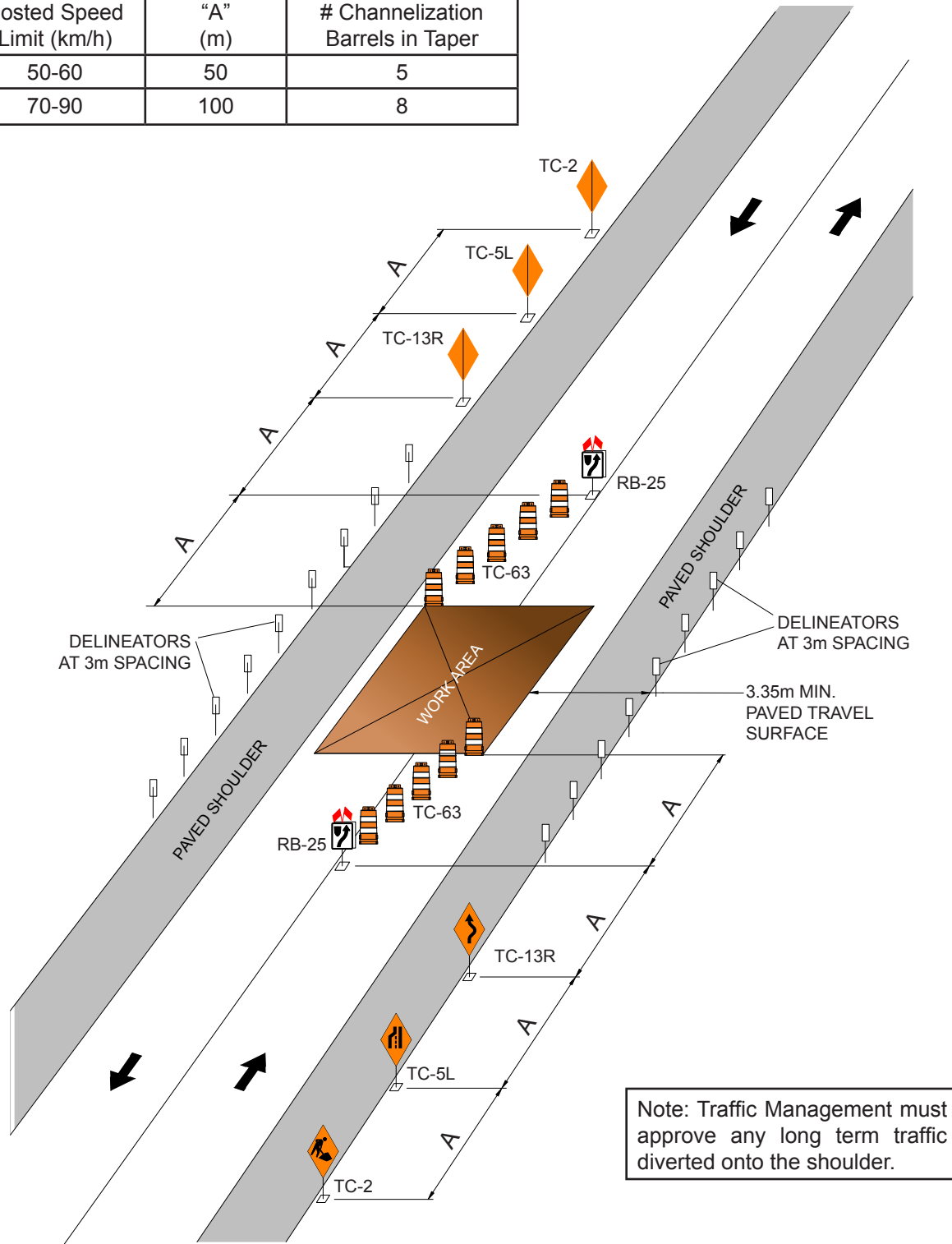

Note: Traffic Management must approve any long term traffic diverted onto the shoulder.

**FIGURE 18**

**USE OF FLAGPERSONS FOR ON-STREET AND OFF-STREET CONSTRUCTION**

Permanent Posted Speed Limit (km/h)	Distance "A" (m)	Minimum # Channelization Barrels in Taper
50-60	50	5
70-90	100	8

**On-Street Construction**

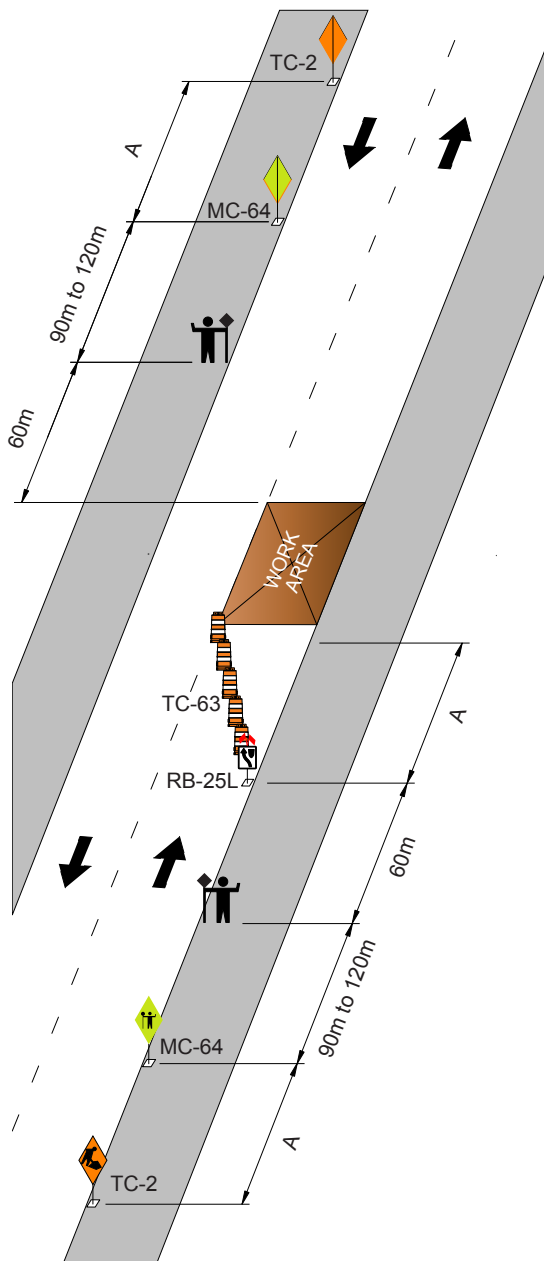

**Off-Street Construction (Flagging for Truck Access)**

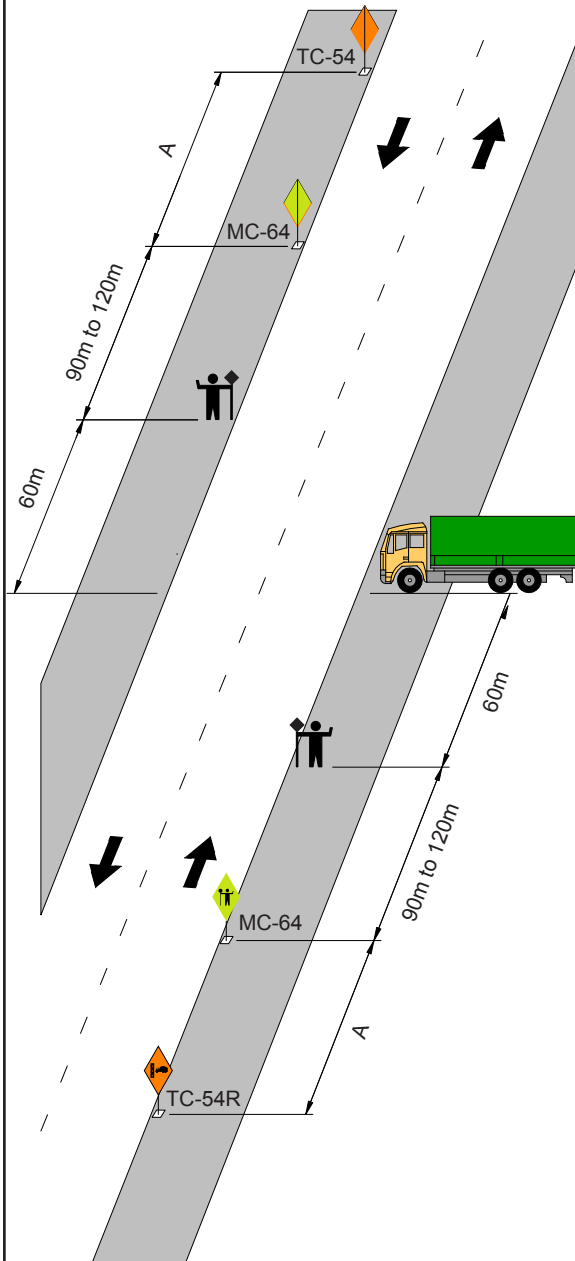

**FIGURE 19**

**LONG TERM BIKE FACILITY CLOSURE WITH DETOUR**

This figure illustrates bicycle related signs for a situation where a section of a bike facility is closed and a reasonable detour route can be provided..

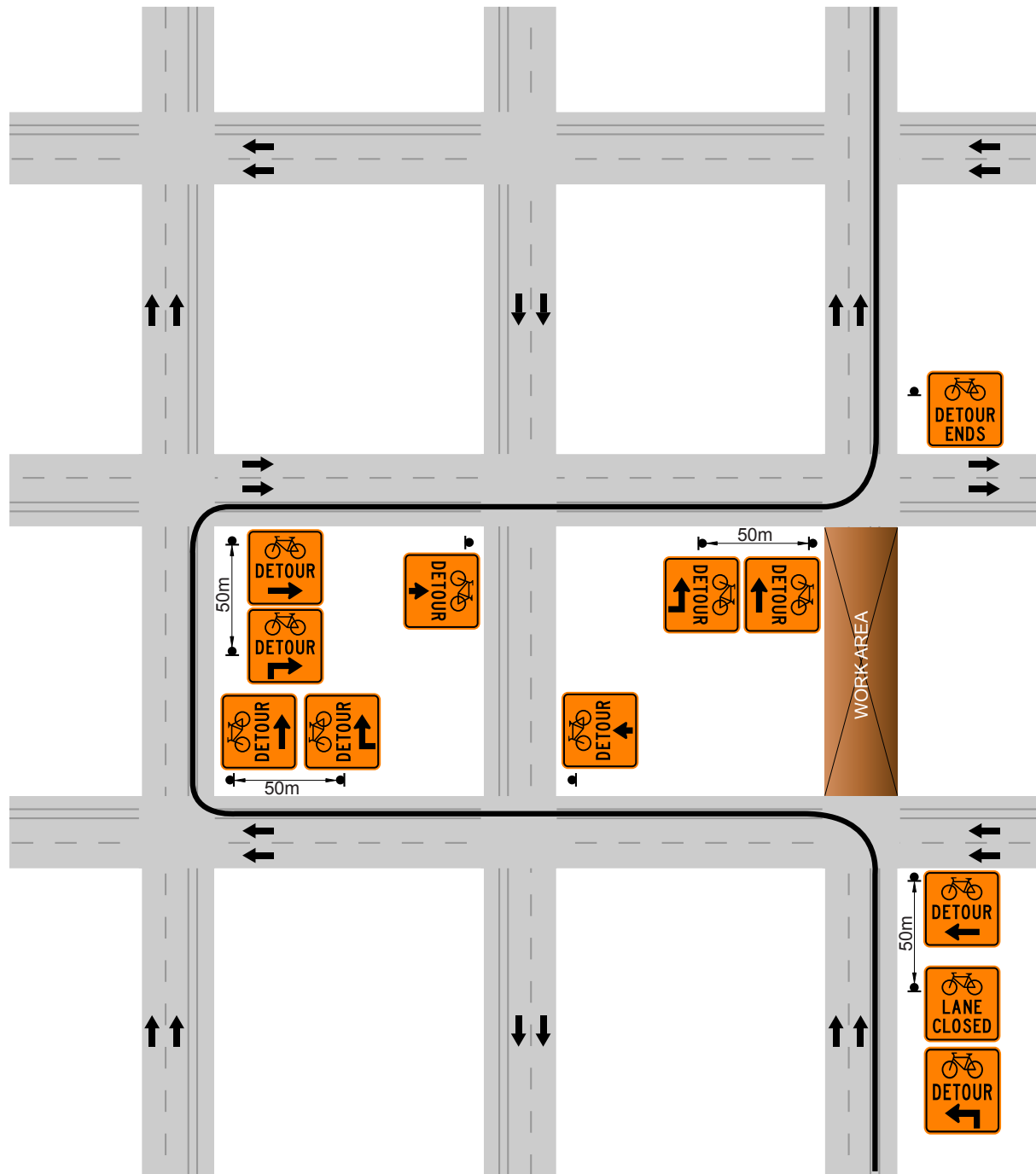
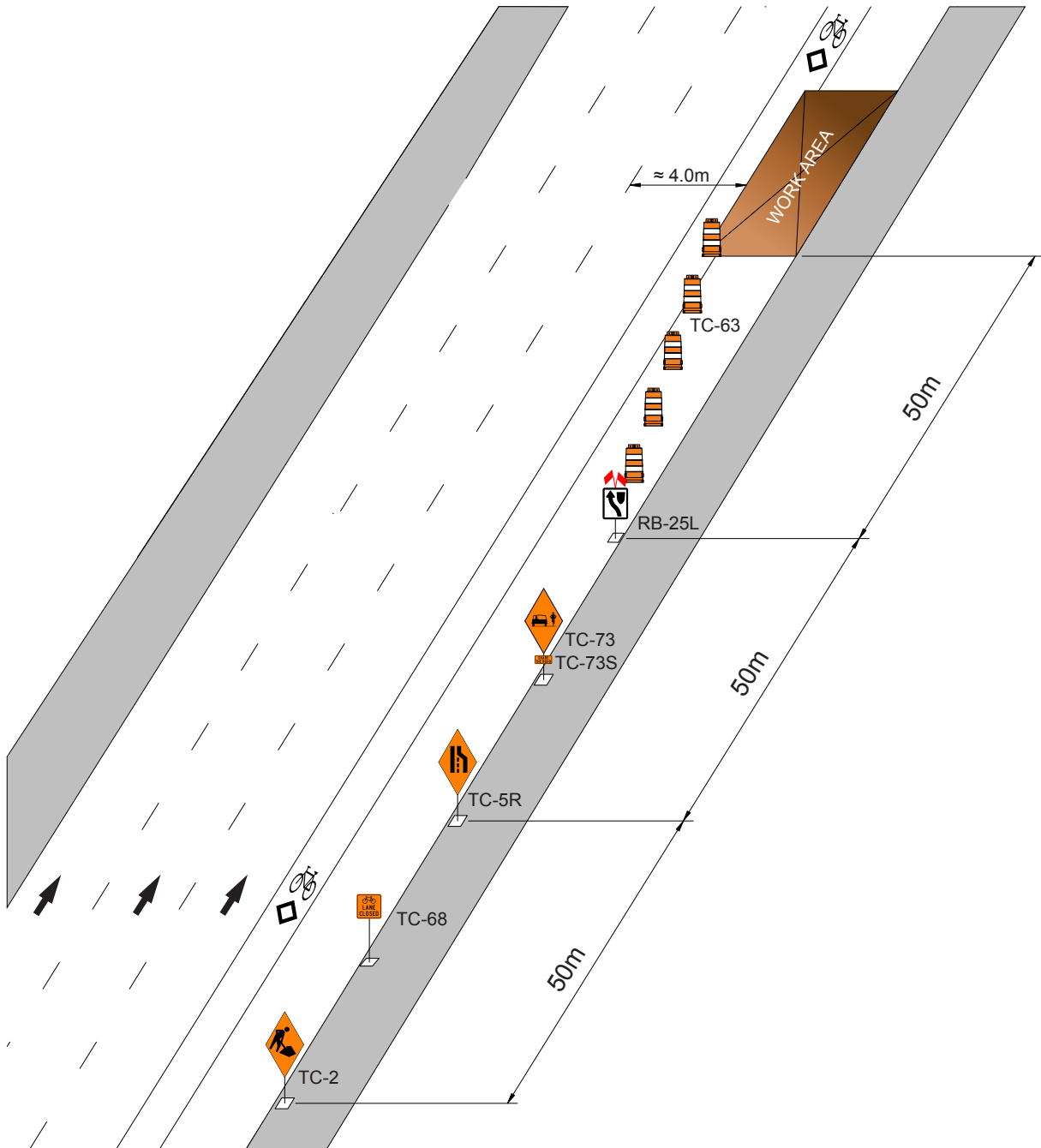



**FIGURE 20**

**LONG TERM BIKE FACILITY CLOSURE WITHOUT A DETOUR**

This figure illustrates bicycle related signs for a situation where a section of a bike facility is affected by construction and bicycles must share a lane with vehicle traffic in order to continue along the route. The shared lane should be approximately 4.0m in width.

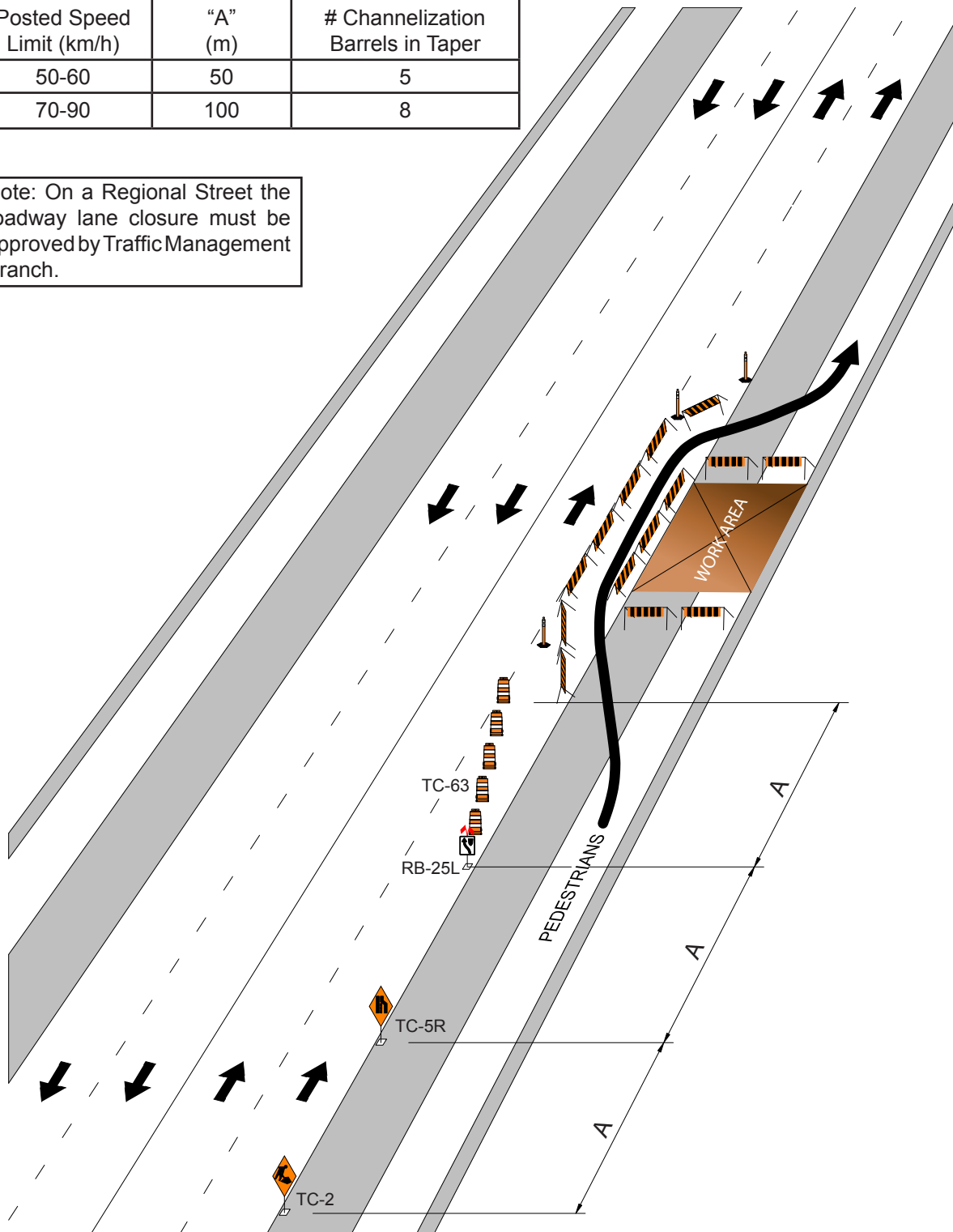

**FIGURE 21**

**LONG TERM CLOSURE OF A SIDEWALK WITH  
PEDESTRIANS DIVERTED ONTO ROADWAY**

Permanent Posted Speed Limit (km/h)	Distance "A" (m)	Minimum # Channelization Barrels in Taper
50-60	50	5
70-90	100	8

Note: On a Regional Street the roadway lane closure must be approved by Traffic Management Branch.



**FIGURE 22**

**LONG TERM COVERED WALKWAY ON ROADWAY**

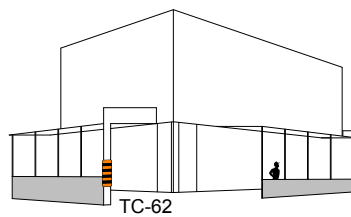
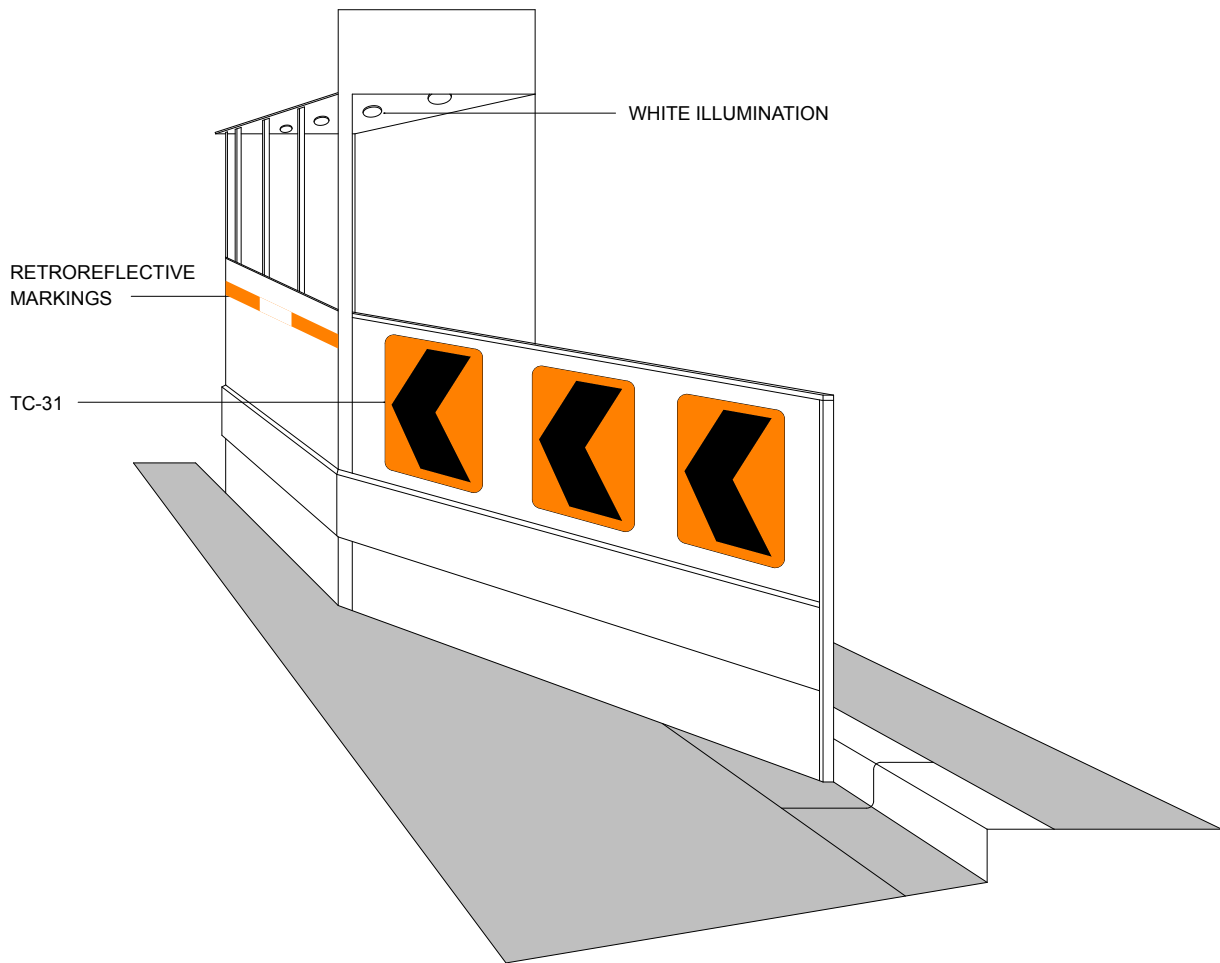

Note: Install advance signing as specified in Figure 21 in conjunction with covered walkway on the roadway.

**FIGURE 23**

**LONG TERM CLOSURE OF A SIDEWALK**

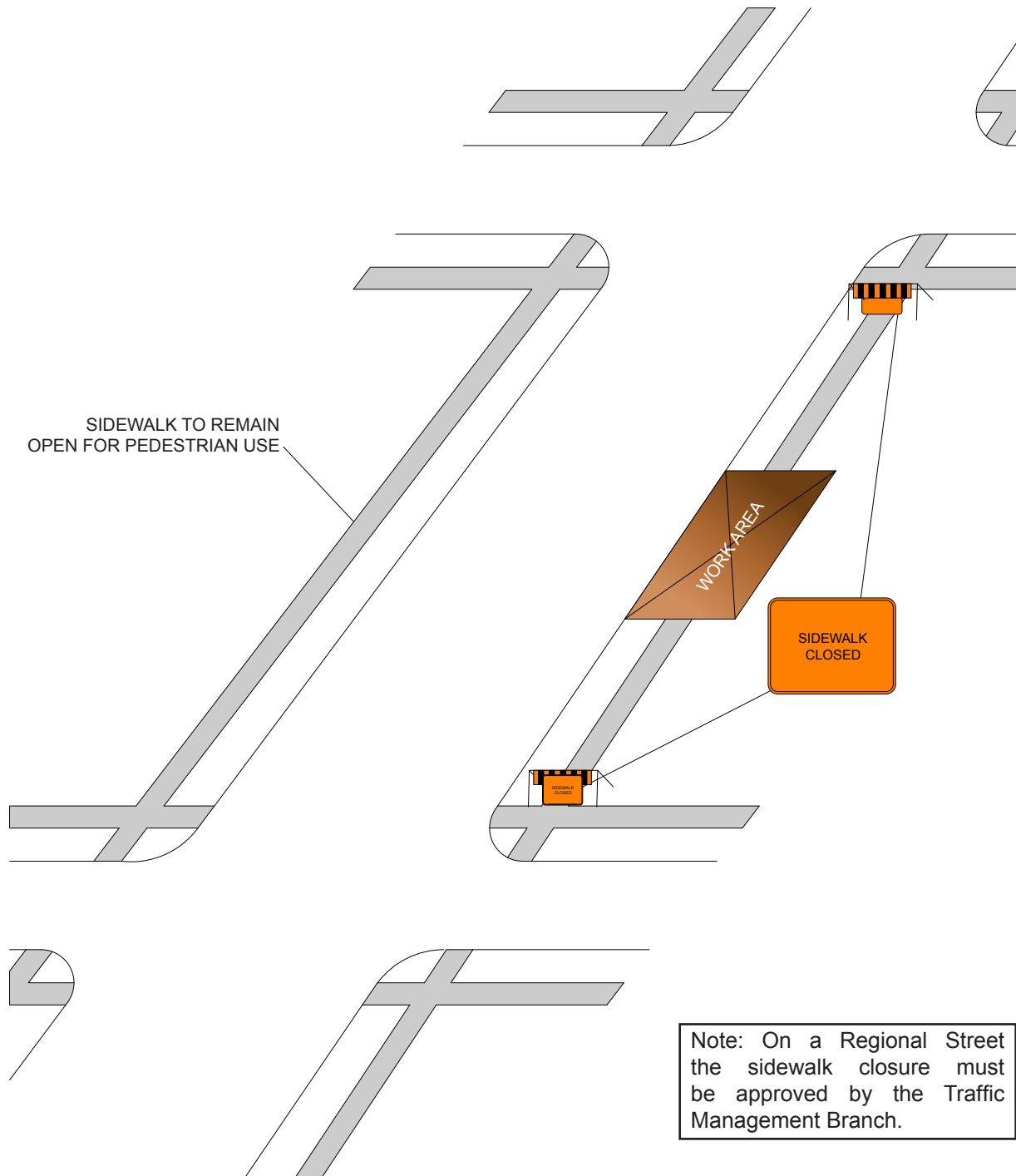

**FIGURE 24**

**LONG TERM PARTIAL BLOCKAGE OF A SIDEWALK**

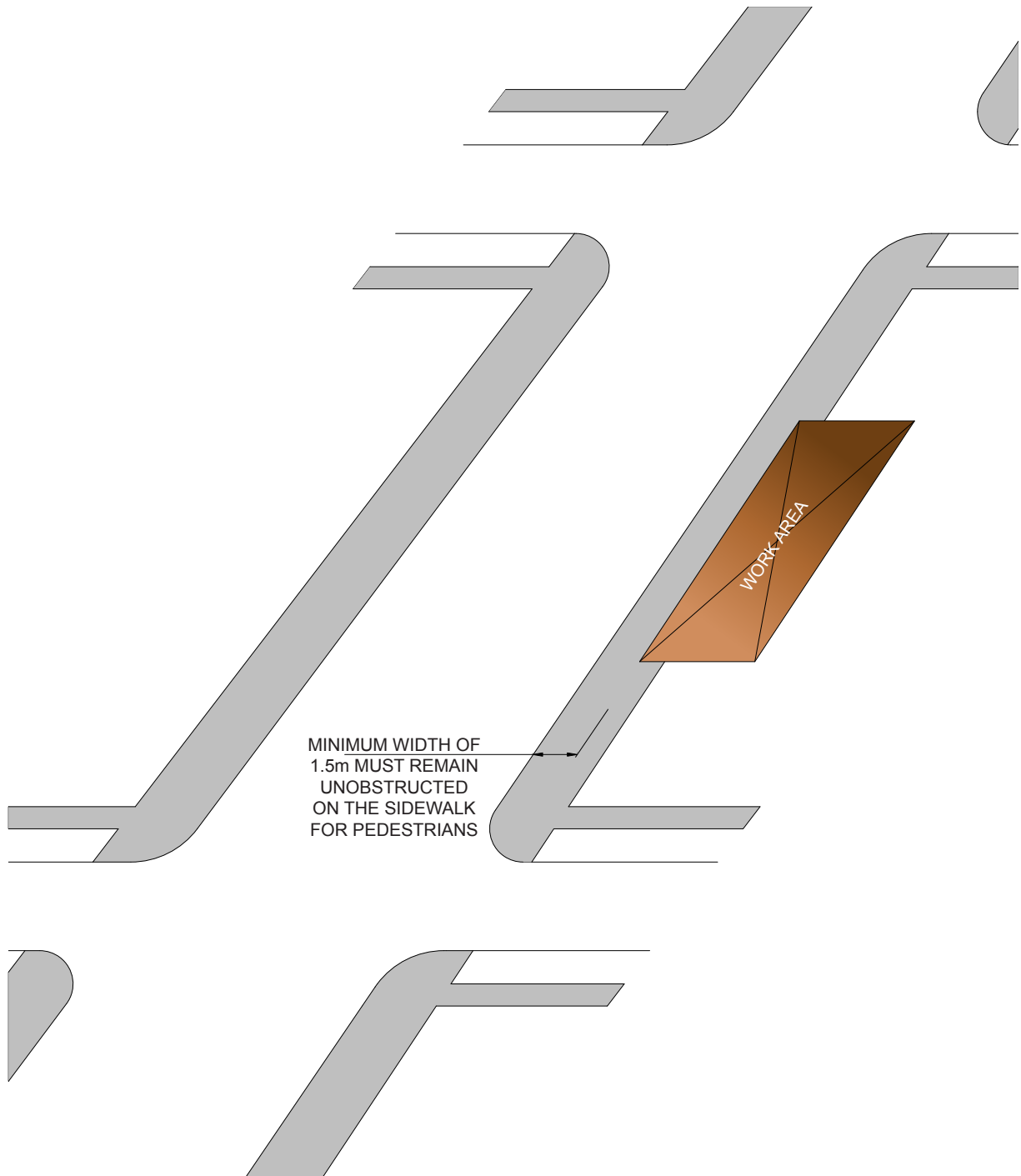
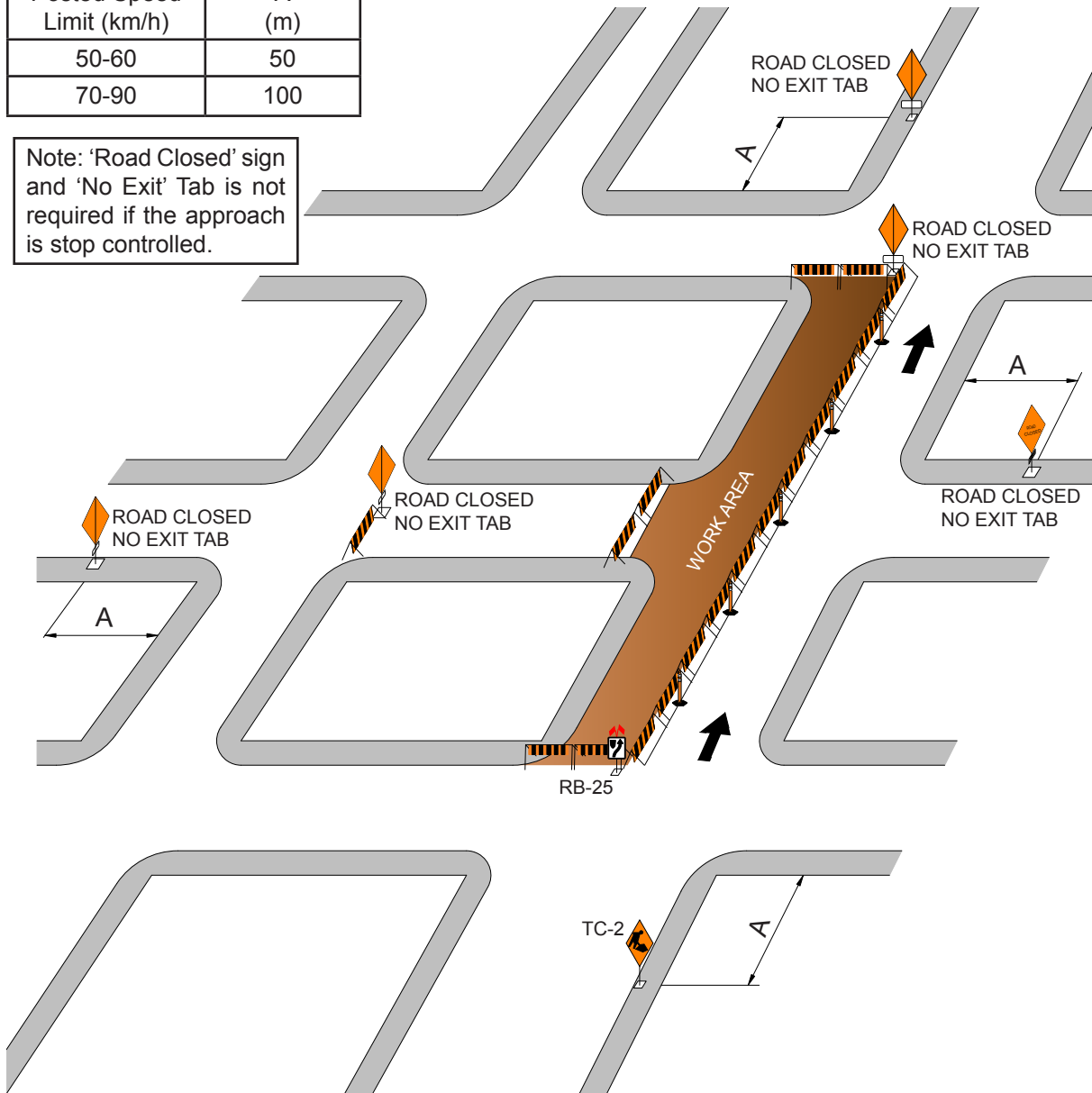

**FIGURE 25**

**LONG TERM DIRECTIONAL CLOSURE OF A NON-REGIONAL STREET**

Permanent Posted Speed Limit (km/h)	Distance "A" (m)
50-60	50
70-90	100

Note: 'Road Closed' sign and 'No Exit' Tab is not required if the approach is stop controlled.



- Notes:
- Required regulatory signs to be placed by Traffic Services are not shown in the illustration.
  - Construction markers or panels can be used in place of tall cones.
  - A list of Regional Streets is contained in Schedule "E" of The City of Winnipeg Streets By-law #1481/77 (all of the streets are classified as non-regional local streets).

**FIGURE 26**

**LONG TERM CLOSURE OF HALF OF A NON-REGIONAL STREET**

Permanent Posted Speed Limit (km/h)	Distance "A" (m)	Minimum # Channelization Barrels in Taper
50-60	50	5
70-90	100	8 </td

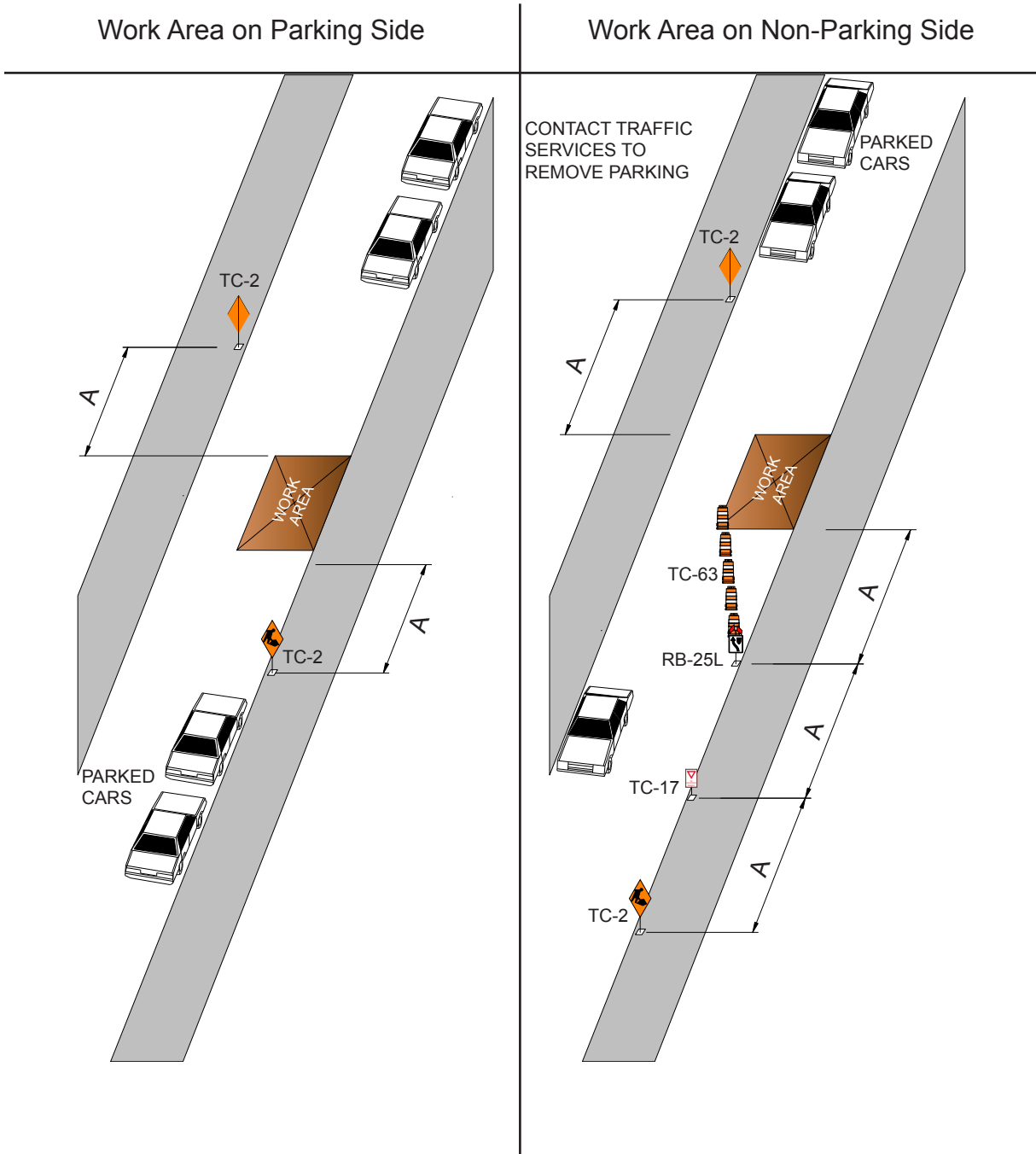

**FIGURE 27**  
**LONG TERM FULL CLOSURE OF ONE BLOCK OF A NON-REGIONAL STREET**

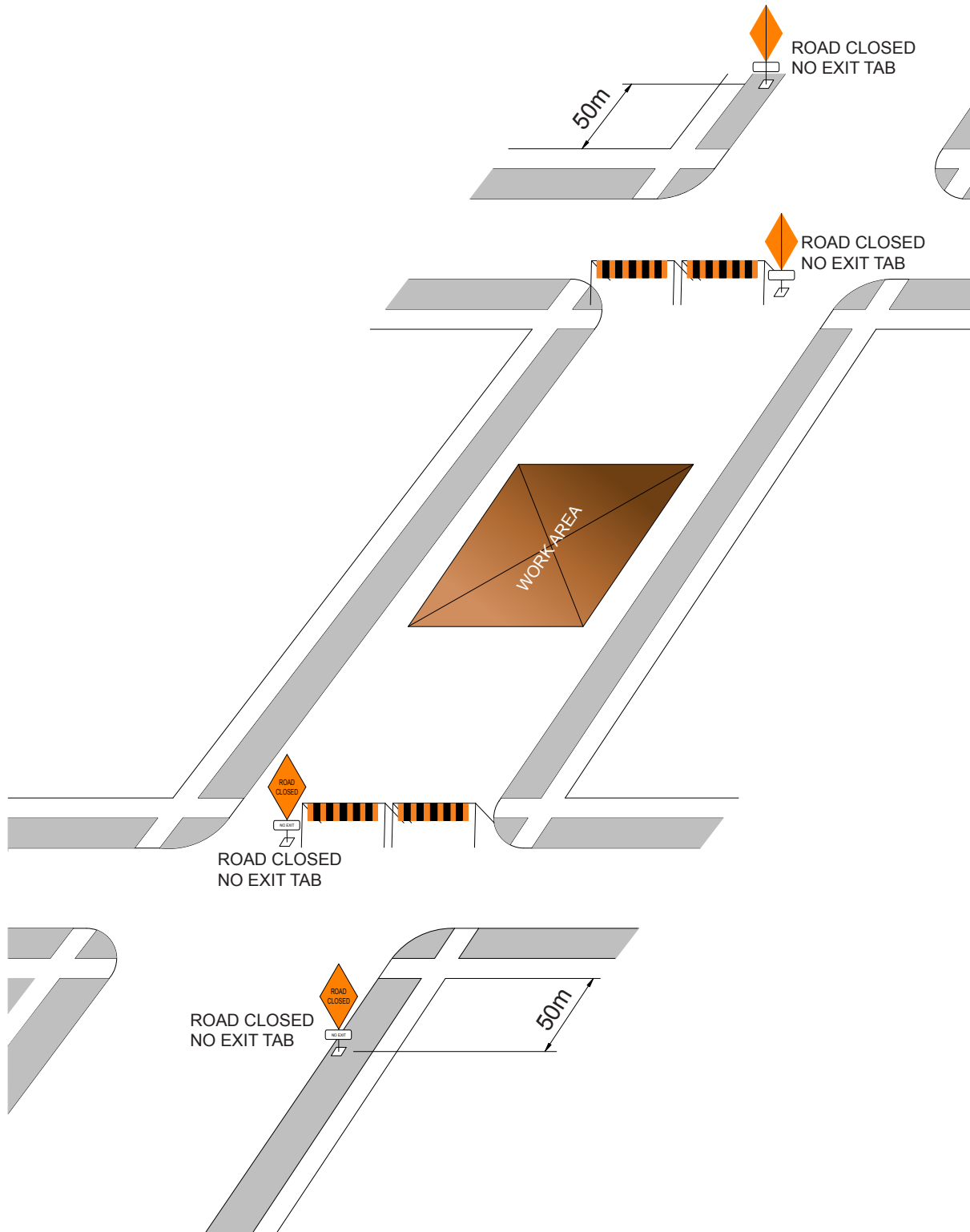
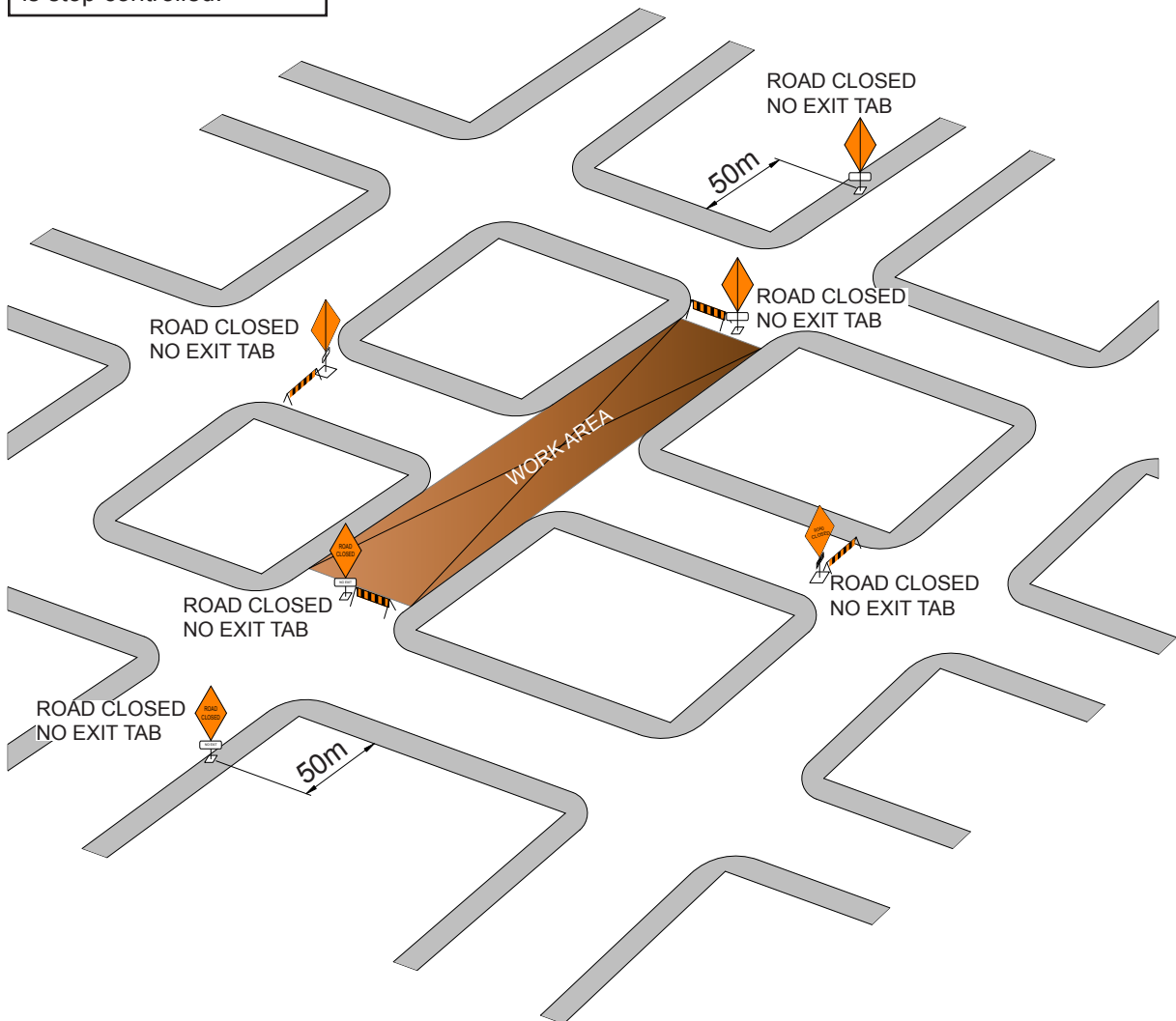



**FIGURE 28**

**LONG TERM FULL CLOSURE OF SEVERAL BLOCKS  
OF A NON-REGIONAL STREET**

Note: 'Road Closed' sign and 'No Exit' Tab is not required if the approach is stop controlled.



**FIGURE 29**  
**LONG TERM CLOSURE OF ONE QUADRANT OF A ROUNDABOUT**  
**ON A NON-REGIONAL STREET**

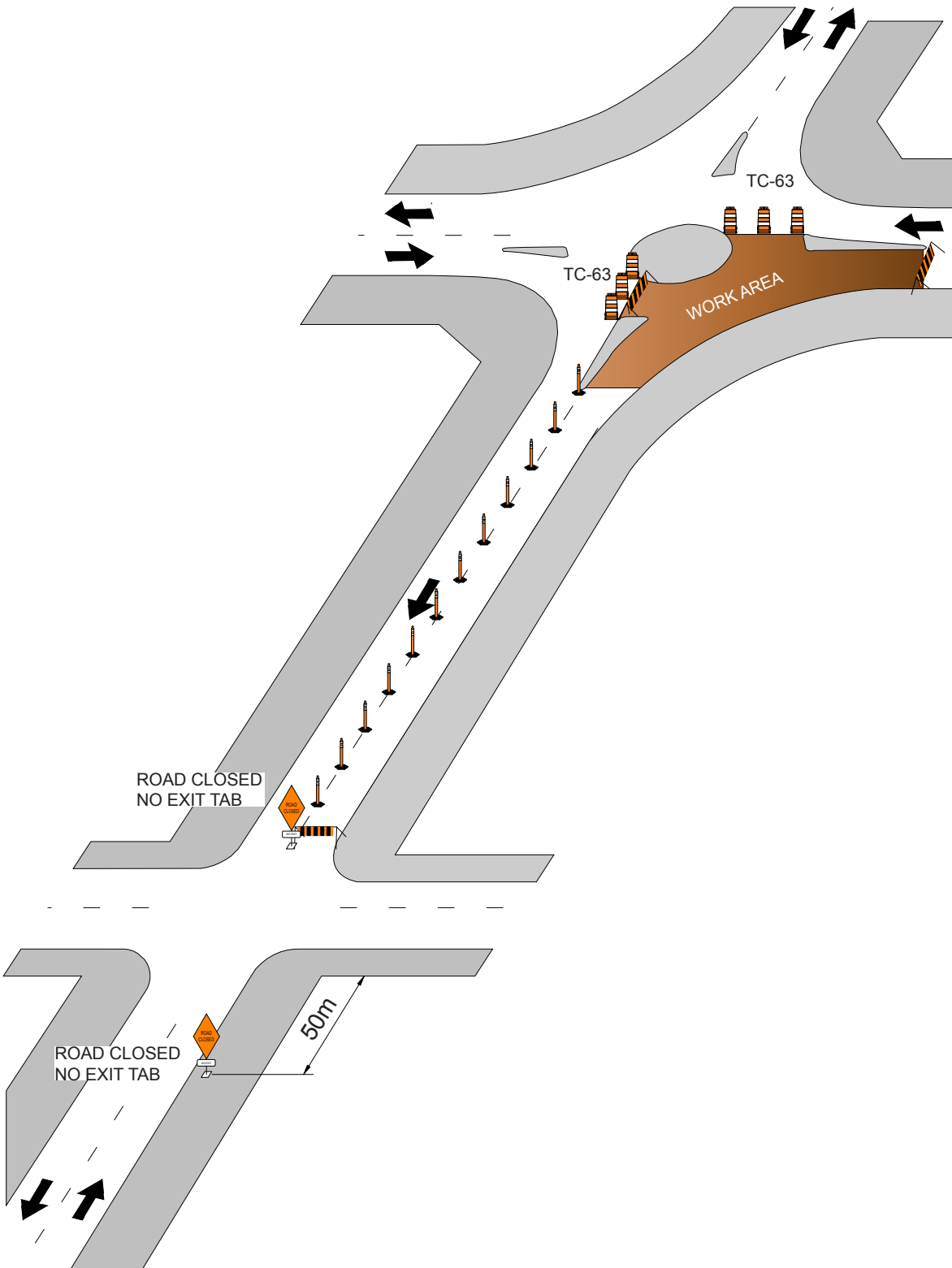

**FIGURE 30**

**LONG TERM MAINTENANCE OF GRANULAR SURFACE ROADWAYS**

Permanent Posted Speed Limit (km/h)	Distance "A" (m)
50-60	50
70-90	100



WD-A69 MAY BE SUBSTITUTED FOR WD-A65 IN THE SETUP

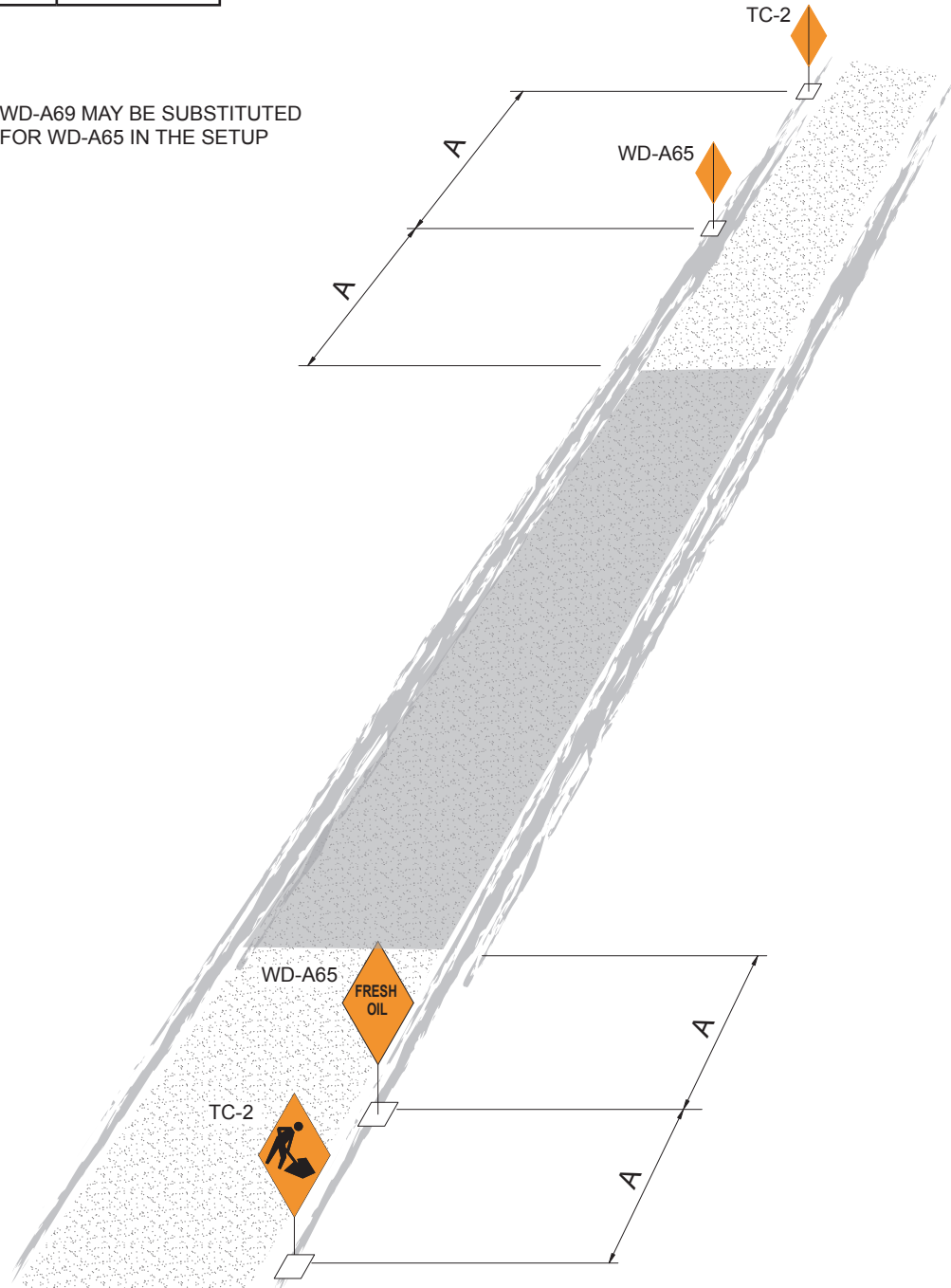

**FIGURE 31a**

**SHORT TERM (GREATER THAN 30 MINUTES AND UP TO 2 HOURS)  
CLOSURE OF CURB LANE OR LANES**

**Speed Limit 50 km/h or 60 km/h**  
Minimum 7 cones per 50m taper

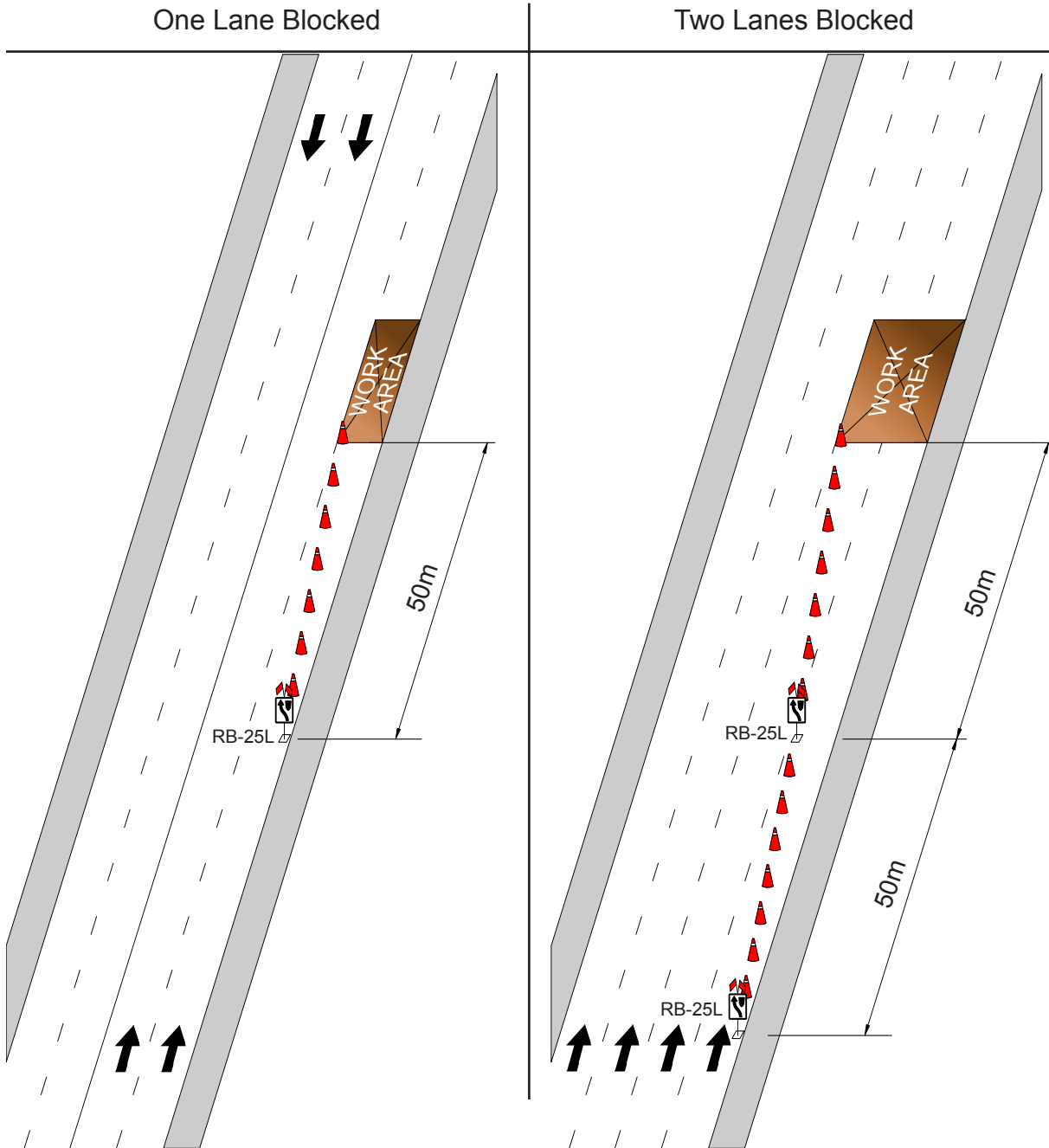

Note: Short term closures may not be used at night without written consent from the Traffic Management Branch (204-986-5640). Use of a flashing or sequential arrow traffic control device is a requirement for work at night.

**FIGURE 31b**

**SHORT TERM (GREATER THAN 30 MINUTES AND UP TO 2 HOURS)  
CLOSURE OF CURB LANE OR LANES**

**Speed Limit 70, 80 or 90 km/h**  
Minimum 12 cones per 100m taper

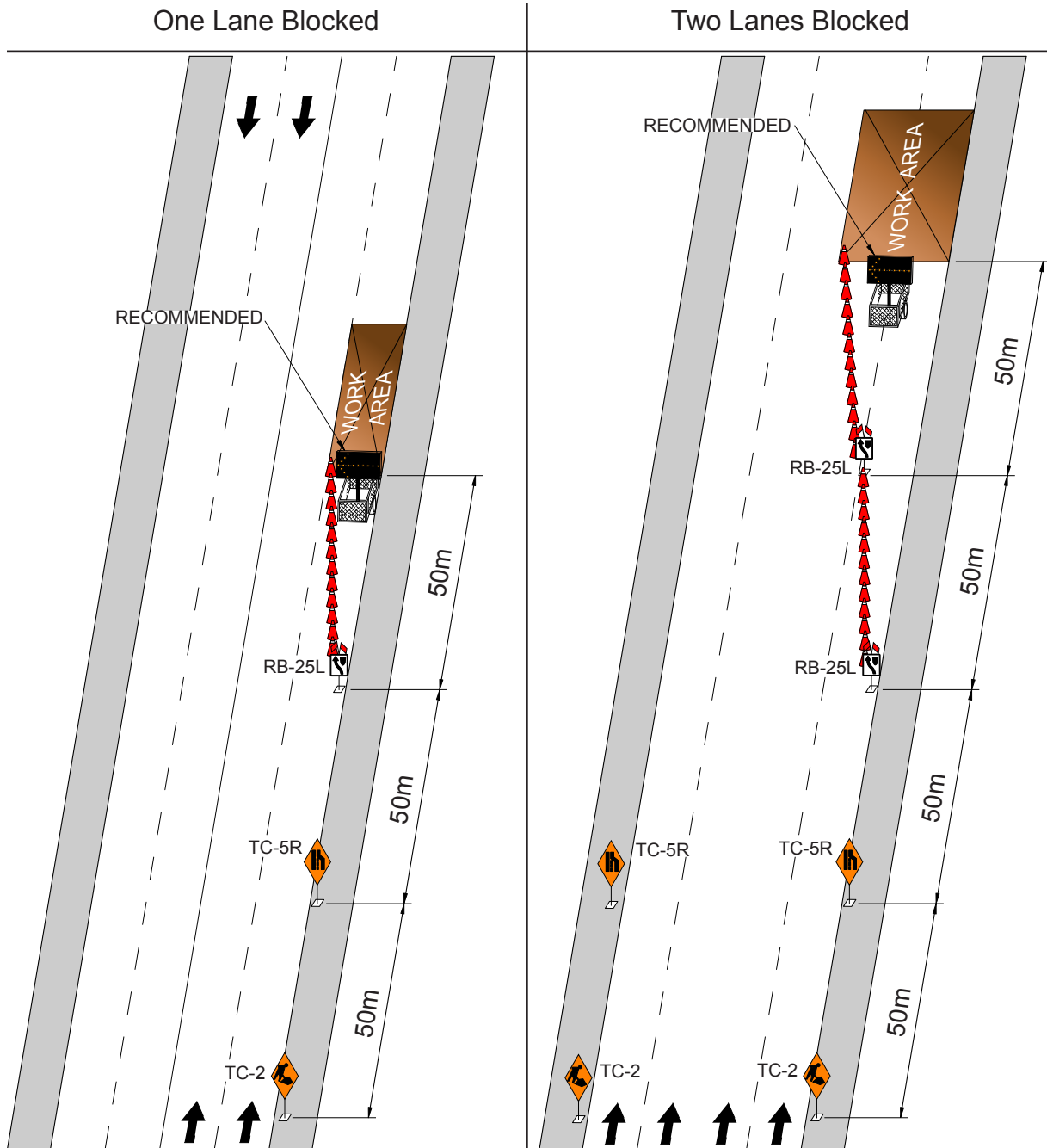

Note: Short term closures may not be used at night without written consent from the Traffic Management Branch (204-986-5640). Use of a flashing or sequential arrow traffic control device is a requirement for work at night.

**FIGURE 32a**

**SHORT TERM (GREATER THAN 30 MINUTES AND UP TO 2 HOURS)  
CLOSURE OF MEDIAN LANE OR LANES**

**Speed Limit 50 km/h or 60 km/h**  
Minimum 7 cones per 50m taper

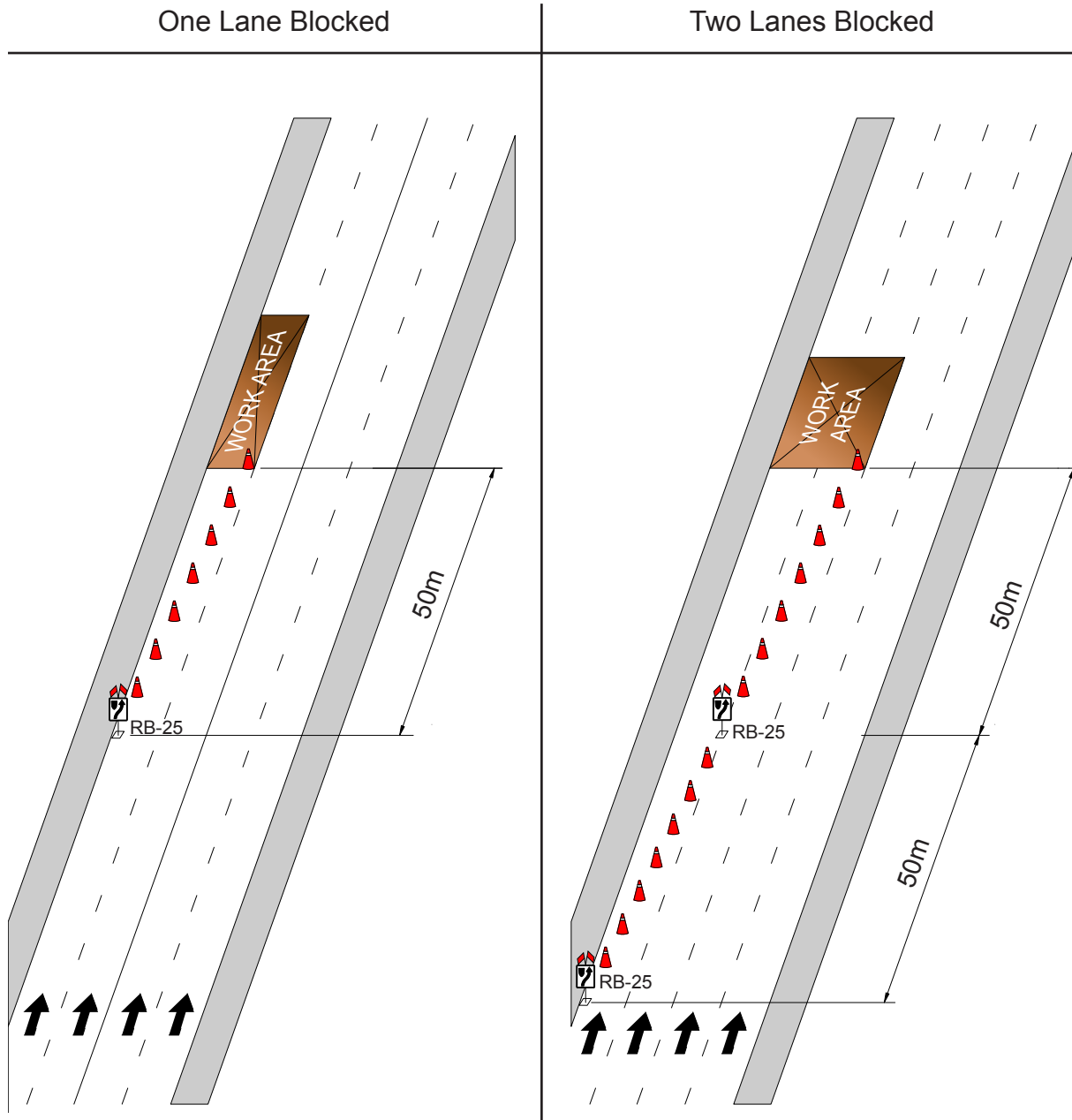

Note: Short term closures may not be used at night without written consent from the Traffic Management Branch (204-986-5640). Use of a flashing or sequential arrow traffic control device is a requirement for work at night.

**FIGURE 32b**

**SHORT TERM (GREATER THAN 30 MINUTES AND UP TO 2 HOURS)  
CLOSURE OF MEDIAN LANE OR LANES**

**Speed Limit 70, 80 or 90 km/h**  
Minimum 12 cones per 100m taper

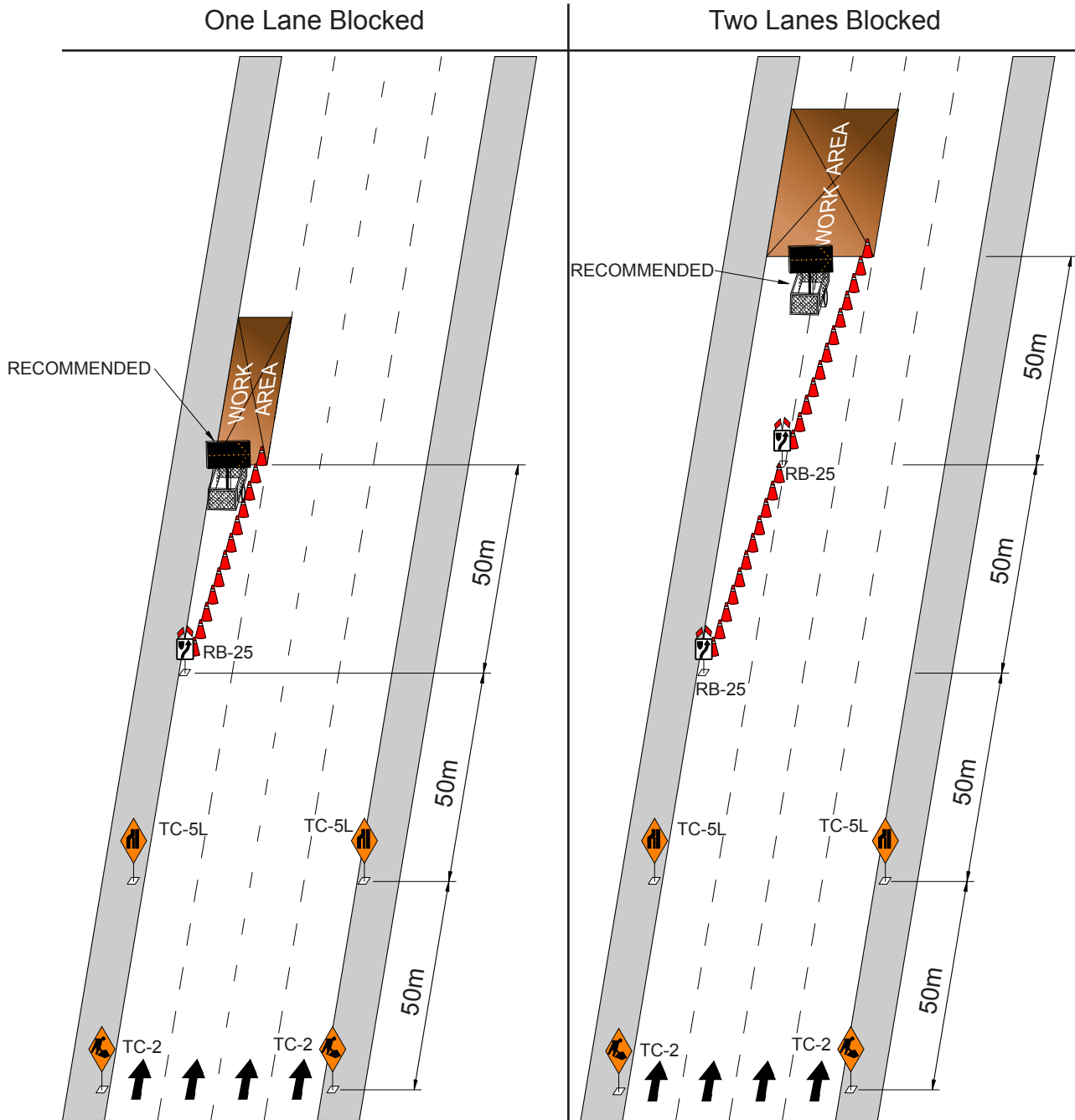

Note: Short term closures may not be used at night without written consent from the Traffic Management Branch (204-986-5640). Use of a flashing or sequential arrow traffic control device is a requirement for work at night.

**FIGURE 33a**

**SHORT TERM (GREATER THAN 30 MINUTES AND UP TO 2 HOURS)  
CLOSURE OF CENTRE LANE OR LANES**

**Speed Limit 50 km/h or 60 km/h**  
Minimum 7 cones per 50m taper

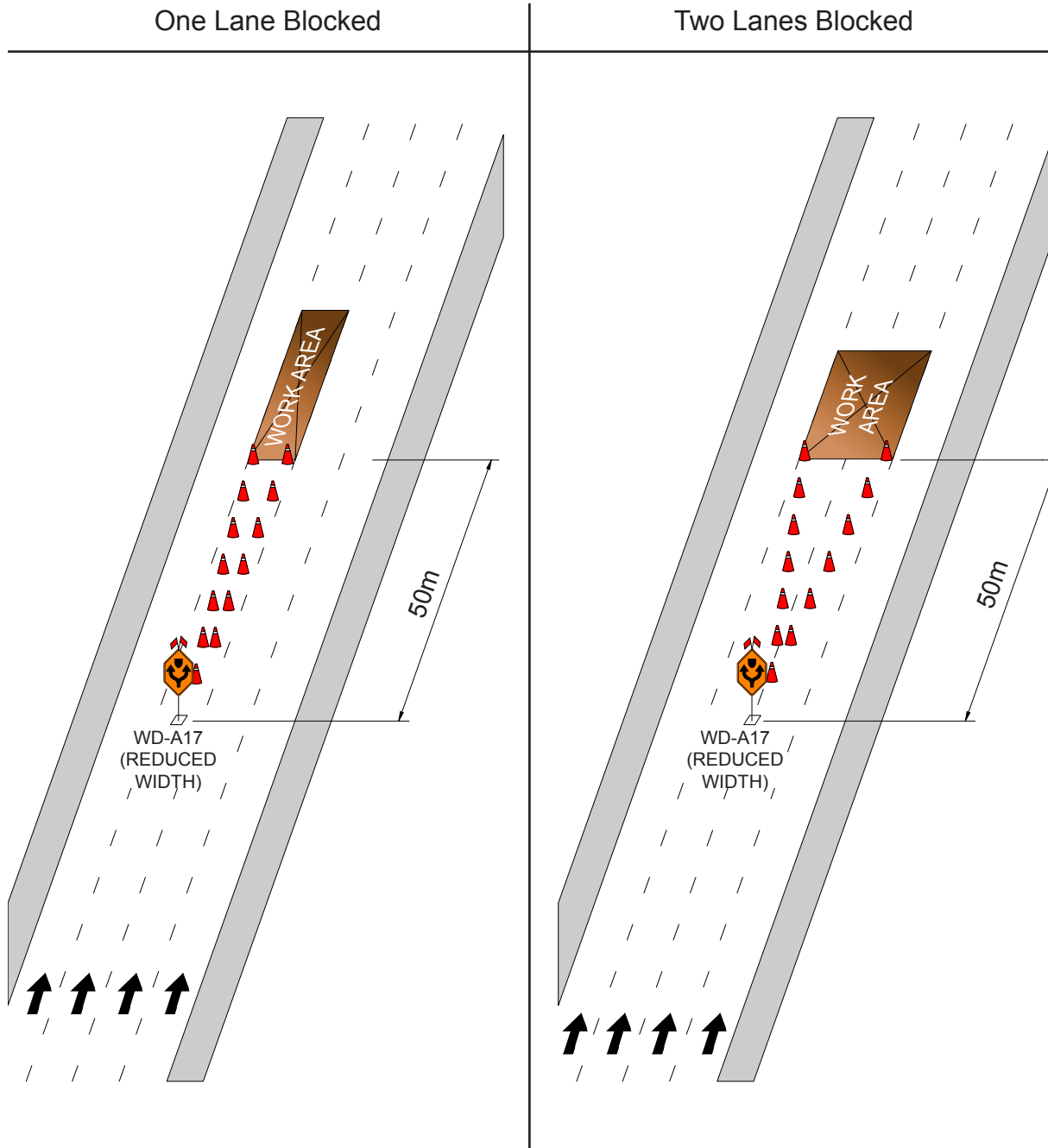

Note: Short term closures may not be used at night without written consent from the Traffic Management Branch (204-986-5640). Use of a flashing or sequential arrow traffic control device is a requirement for work at night.



**FIGURE 33b**

**SHORT TERM (GREATER THAN 30 MINUTES AND UP TO 2 HOURS)  
CLOSURE OF CENTRE LANE OR LANES**

**Speed Limit 70, 80 or 90 km/h**  
Minimum 12 cones per 100m taper

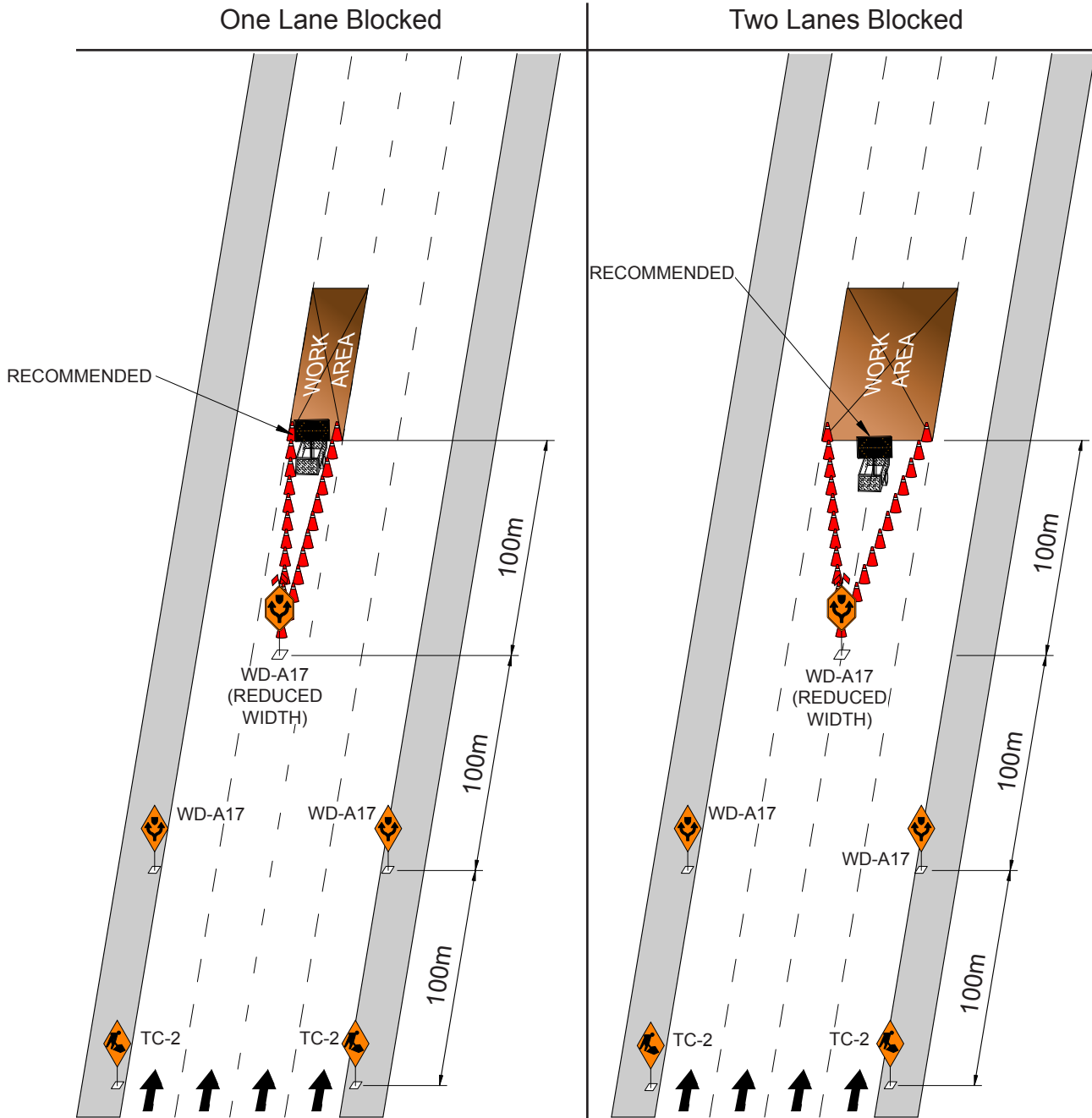

Note: Short term closures may not be used at night without written consent from the Traffic Management Branch (204-986-5640). Use of a flashing or sequential arrow traffic control device is a requirement for work at night.

**FIGURE 34**

**SHORT TERM (GREATER THAN 30 MINUTES AND UP TO 2 HOURS)  
CLOSURE ON A HORIZONTAL CURVE**

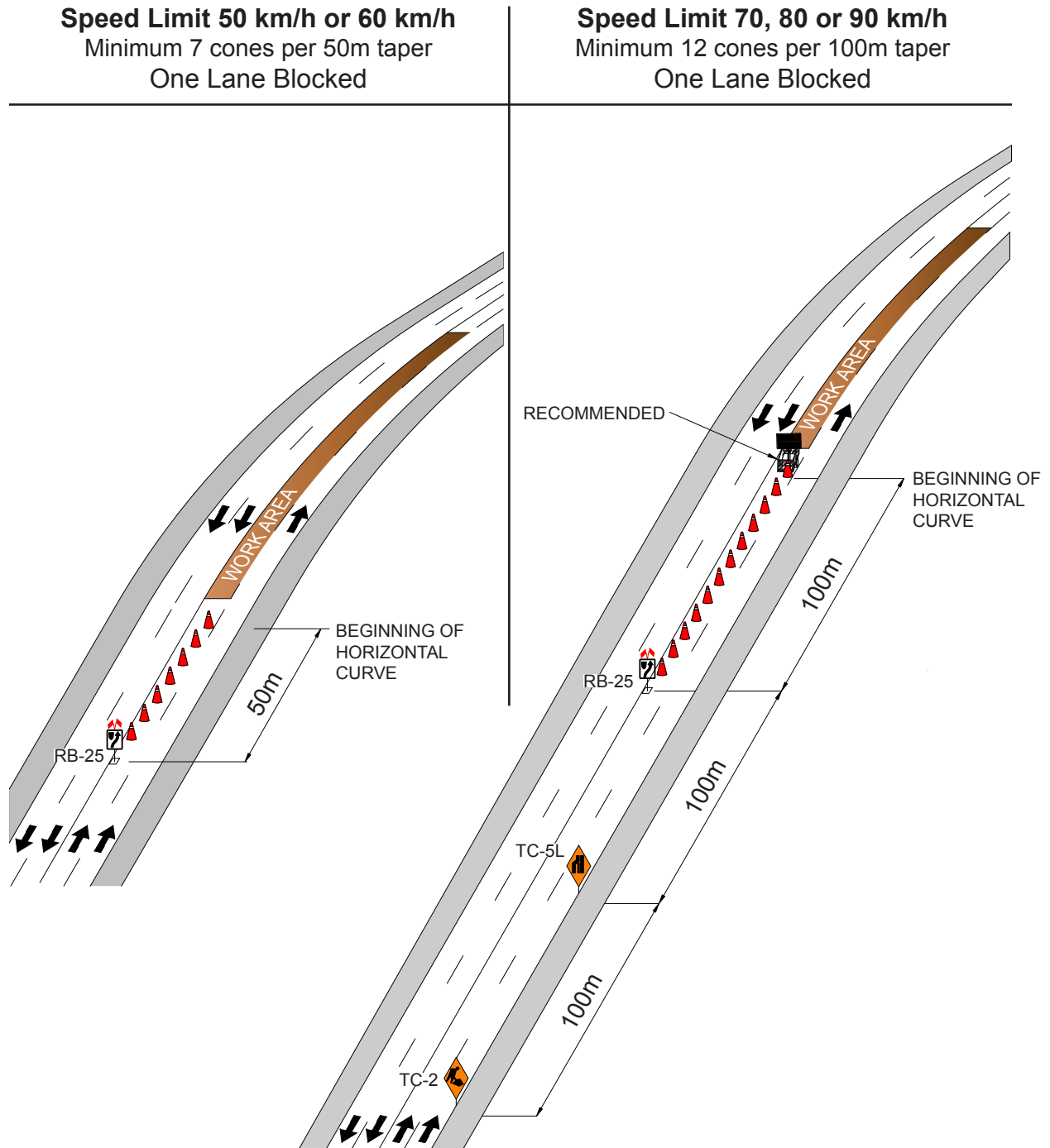

Note: Short term closures may not be used at night without written consent from the Traffic Management Branch (204-986-5640). Use of a flashing or sequential arrow traffic control device is a requirement for work at night.

**FIGURE 35**

**SHORT TERM (GREATER THAN 30 MINUTES AND UP TO 2 HOURS)  
CLOSURE ON A VERTICAL CURVE**

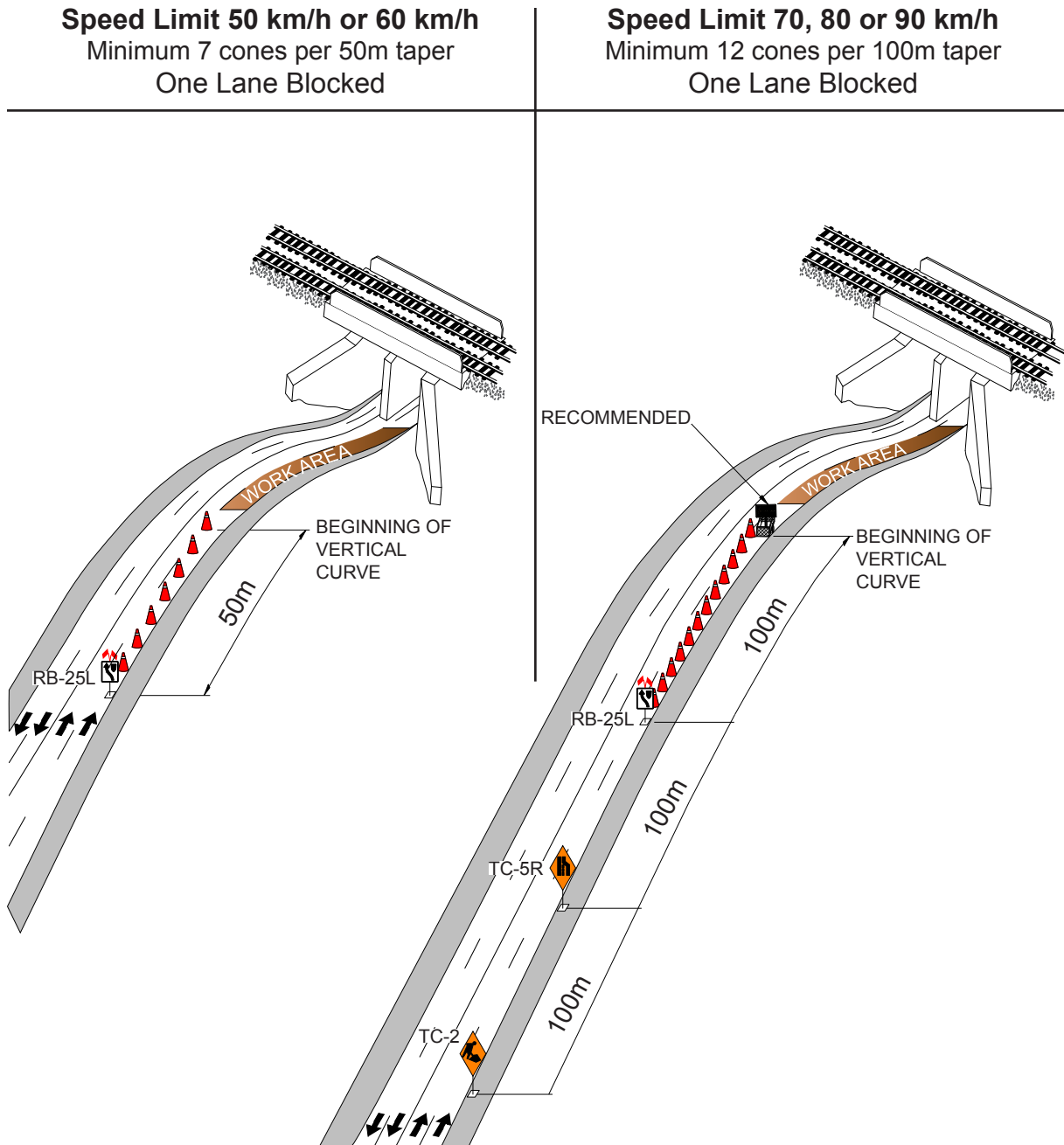

Note: Short term closures may not be used at night without written consent from the Traffic Management Branch (204-986-5640). Use of a flashing or sequential arrow traffic control device is a requirement for work at night.

**FIGURE 36a**

**SHORT TERM (GREATER THAN 30 MINUTES AND UP TO 2 HOURS) CLOSURE  
OF A CURB LANE OR MEDIAN LANE ADJACENT TO AN INTERSECTION**

**Speed Limit 50 km/h or 60 km/h**

Minimum 7 cones per 50m taper

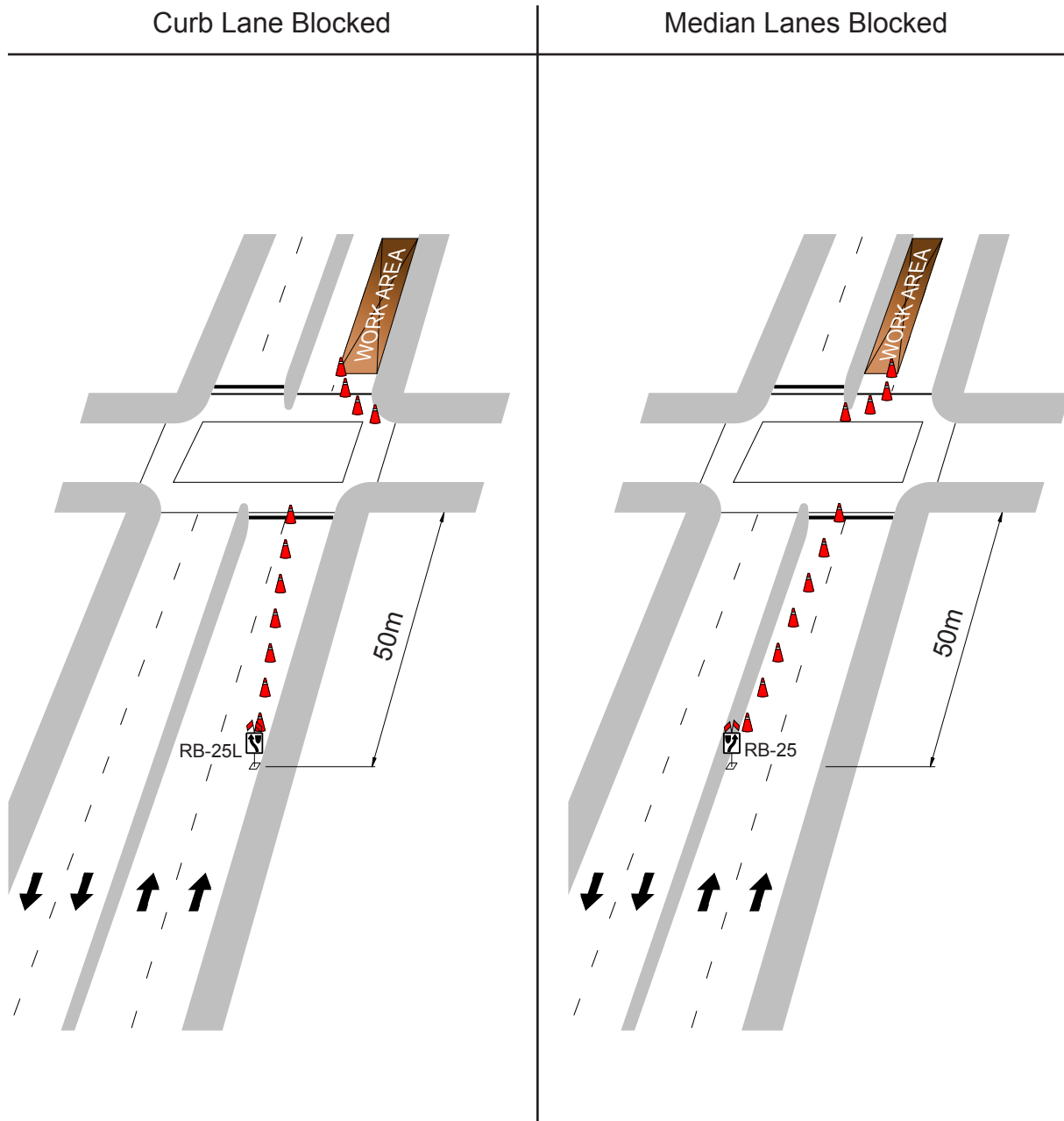

Note: Short term closures may not be used at night without written consent from the Traffic Management Branch (204-986-5640). Use of a flashing or sequential arrow traffic control device is a requirement for work at night.

**FIGURE 36b**

**SHORT TERM (GREATER THAN 30 MINUTES AND UP TO 2 HOURS) CLOSURE  
OF A CURB LANE OR MEDIAN LANE ADJACENT TO AN INTERSECTION**

**Speed Limit 70, 80 or 90 km/h**  
Minimum 12 cones per 100m taper

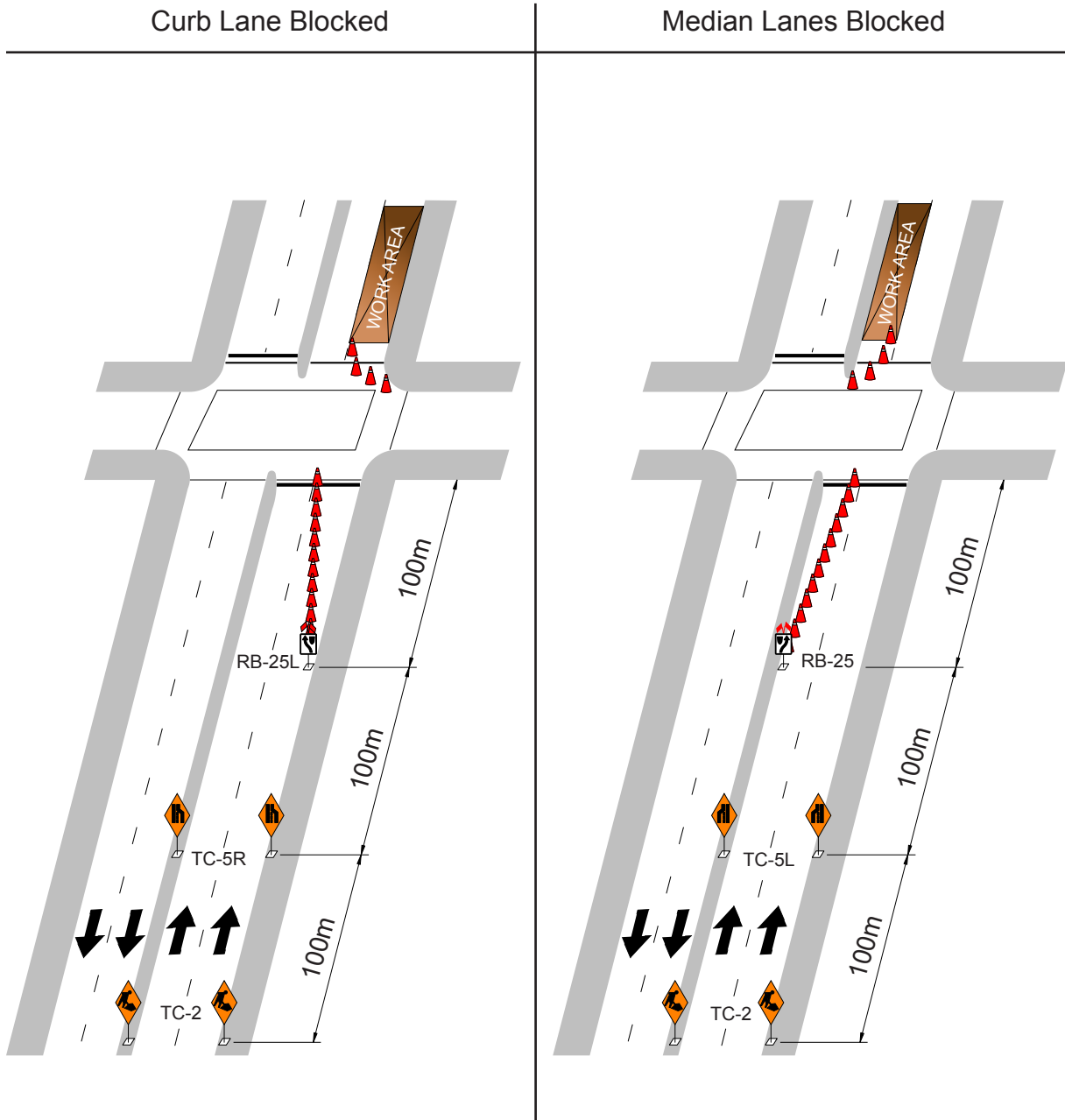

Note: Short term closures may not be used at night without written consent from the Traffic Management Branch (204-986-5640). Use of a flashing or sequential arrow traffic control device is a requirement for work at night.

**FIGURE 37**

**SHORT TERM (GREATER THAN 30 MINUTES AND UP TO 2 HOURS) CLOSURE  
WITHIN AN INTERSECTION EIGHT LANE AND SIX LANE DIVIDED HIGHWAYS**

**Speed Limit 50 km/h or 60 km/h**  
Minimum 7 cones per 50m taper

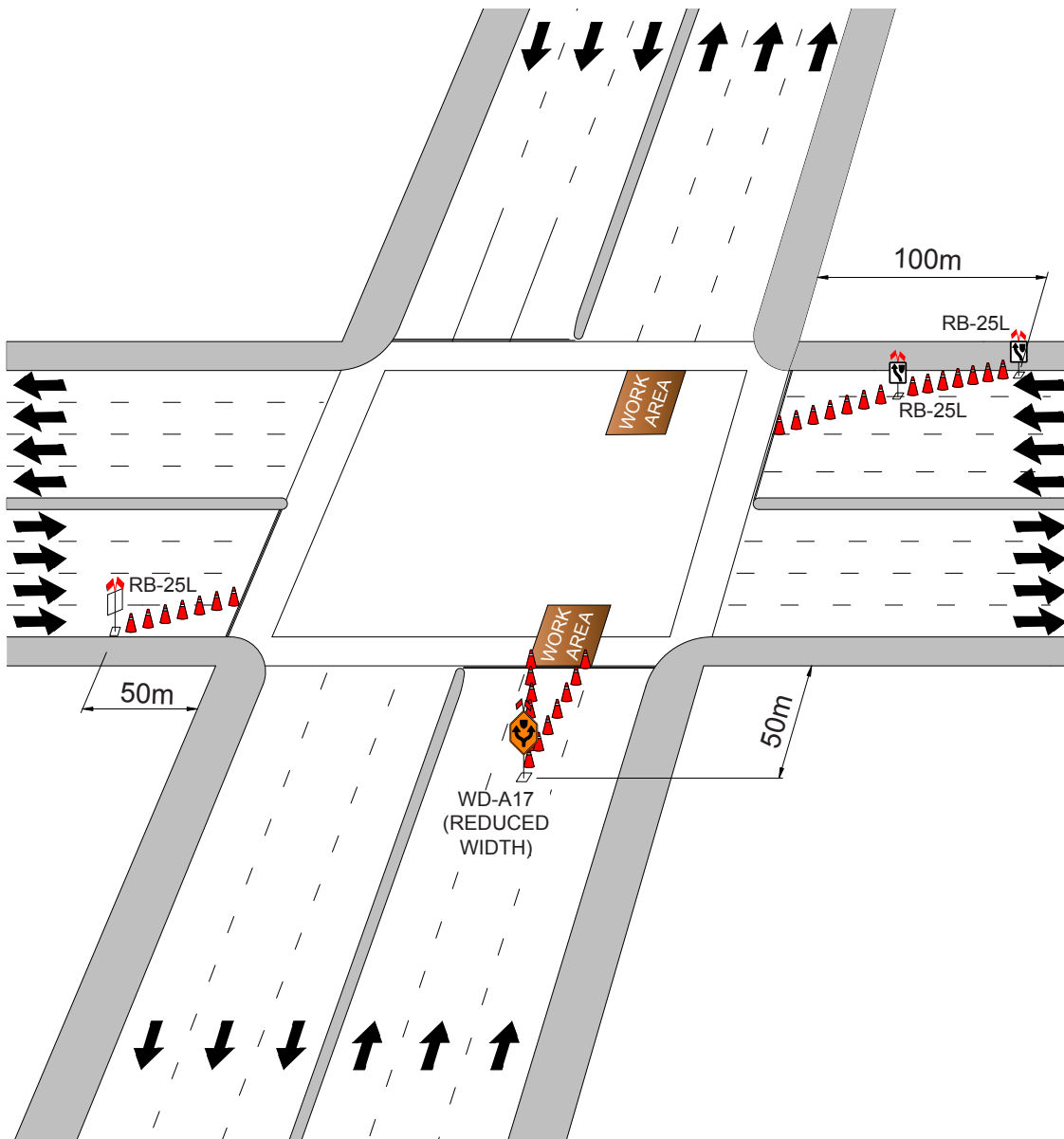

Note: Short term closures may not be used at night without written consent from the Traffic Management Branch (204-986-5640). Use of a flashing or sequential arrow traffic control device is a requirement for work at night.

## MOBILE AND VERY SHORT DURATION WORK ZONES

**(Figure 38)**

Figure 38 depicts vehicles suitably equipped to act as traffic control vehicles for mobile and very short duration work zones (work zones that move continuously or intermittently stopping at a fixed location for up to 30 minutes). The devices shall conform to the requirement of Section 5.00 and shall be kept clean and in proper working order and the following conditions must prevail.

1. The blockage shall not exceed 30 minutes duration or occur during peak periods.
2. Only one lane is closed at any one time and there must be at least one other lane available for that direction of travel.
3. A buffer vehicle equipped with a flashing or sequential arrow traffic control device must be used where visibility of the work zone is limited by horizontal or vertical curves (example: bridges, overpasses or underpasses). The buffer vehicle should be located at the most visible location available. The table below provides guidance as to appropriate separation distances between the buffer vehicle and the work area.

Speed Limit	50 km/h	60 km/h	70 km/h	80 km/h	90 km/h
Buffer Vehicle to Work Area Separation Distance ('A')	35 m	45 m	50 m	55 m	65 m

4. On streets with a posted speed limit of 70, 80 or 90 km/h, a flashing or sequential arrow traffic control device is required.
5. A flashing or sequential arrow traffic control device is required at night.
6. The flashing or sequential arrow traffic control device must be turned off when traffic control is no longer required or when the vehicle is being moved from one work zone to another.
7. Truck or trailer mounted impact attenuators (also known as crash cushions) are recommended for the first vehicle or trailer in a mobile or very short duration setup on a roadway with a posted speed limit of 70, 80 or 90 km/h.
8. The minimum requirement for streets with 50 km/h or 60 km/h speed limits are:
  - Two flashing amber beacons at least 2.0 m from ground level.
  - Orange and black reflectorized hazard panel with a minimum dimension of 2.0 m by 0.5 m at least 1.0 m from ground level.
  - Two 600 mm x 750 mm reflectorized black on white “Keep Right” (RB-25) and/or “Keep Left” (RB-25L) regulatory signs.
  - Where it is possible to pass on the right, a “Keep Right” sign shall be used. Where it is possible to pass on the left, a “Keep Left” sign shall be used. Where it is possible to pass on either the right or the left, a “Keep Right” and a “Keep Left” sign shall be used. The “Keep Right” and/or “Keep Left” signs mounted on the vehicle must not be visible to motorists when not in use.

**FIGURE 38**

**MOBILE AND VERY SHORT DURATION WORK ZONES**

**Minimum Requirement 50 km/h or 60 km/h Speed Limit**

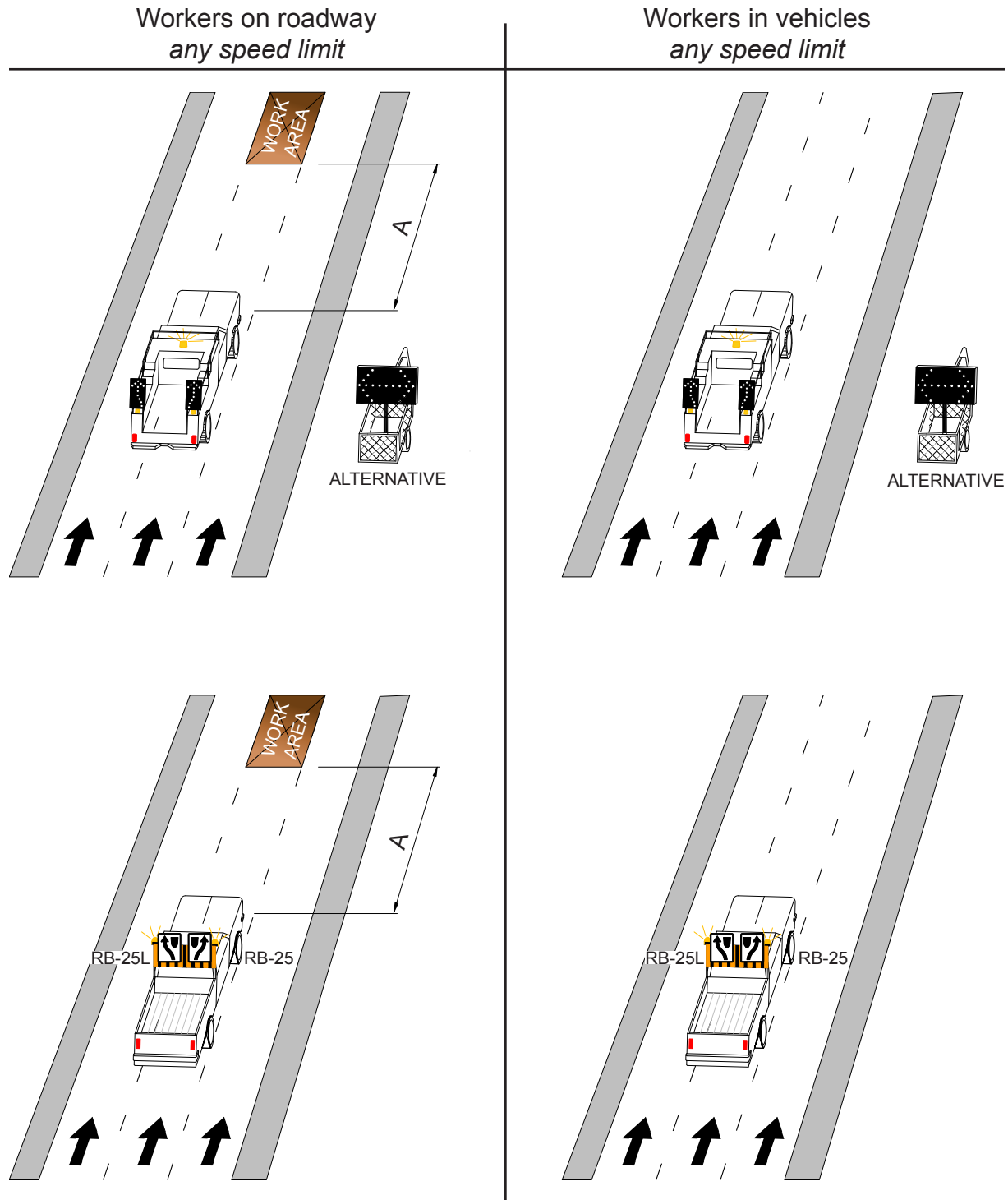



## Appendix List of Regional Streets (May 2014)

<b>STREET</b>	<b>FROM</b>	<b>TO</b>
Academy Road	Maryland Bridge	Kenaston Boulevard
Alexander Avenue	Main Street	Princess Street
Archibald rue	CPR Keewatin Subdivision	Fermor Avenue
Arlington Street	Portage Avenue	Inkster Boulevard
Arlington Street Bridge		
Balmoral Street	Notre Dame Avenue	Ellice Avenue
Bishop Grandin Boulevard	Kenaston Boulevard	Lagimodiere Boulevard
Bison Drive	Kenaston Boulevard (northbound)	Kenaston Boulevard (southbound)
		Pembina Highway
Bison Drive	Waverley Street	Main Street
Broadway	Portage Avenue	Oak Point Highway
Brookside Boulevard	Mollard Road	Broadway
Carlton Street	Notre Dame Avenue	Dublin Avenue
Century Street	St. James Bridge	
Century Street/Portage Avenue Interchange		
Chancellor Matheson Road	Pembina Highway	University Crescent
Chancellor Drive	Pembina Highway	A point 100 m west Lagimodiere Boulevard
Chief Peguis Trail	Main Street	Ellice Avenue
Colony Street	Portage Avenue	York Avenue
Colony Street	St. Mary Avenue	Lagimodiere Blvd.
Concordia Avenue	Gateway Road	
Concordia Overpass		
Cornish Avenue	Maryland Street	Sherbrook Street
Corydon Avenue	Donald Street	Roblin Boulevard
Cumberland Avenue	Maryland Street	Donald Street
Dakota Street	St. Mary's Road	Aldgate Road
Des Meurons rue	Provencher Boulevard	Marion Street
Day Street	Pandora Avenue	Regent Ave West
Disraeli Bridge and Overpass		
Disraeli Freeway	Main Street	Disraeli Bridge
Disraeli Freeway Interchange		
Disraeli Street	Sutherland Avenue	Rover Avenue
Donald Street	Notre Dame Avenue	McMillan Avenue
Dublin Avenue	Notre Dame Avenue	King Edward St.
Dublin Avenue Crossing of Omand's Creek		
Dufferin Avenue	Salter Street	McGregor Street
Dugald Road	Lagimodiere Boulevard	P.T.H. 101
Dugald Road Overpass of the CNR Line West of Terracon Place		

<b>STREET</b>	<b>FROM</b>	<b>TO</b>
Dunkirk Drive	St. Vital Bridge	St. Mary's Road
Dunkirk Drive/Kingston Row/ Churchill Drive Interchange		
Eastway	Empress Street	Empress St. East
Edmonton Street	Broadway	Portage Avenue
Edmonton Street	Ellice Avenue	Cumberland Ave.
Ellice Avenue	Notre Dame Avenue	Ferry Road
Empress Street East	Doreen Street	Rapelje Avenue
Empress Street	Portage Avenue	Wellington Ave.
Empress Street Overpass		
Erin Street	Notre Dame Avenue	Portage Avenue
Fermor Avenue	Dunkirk Drive	Plessis Road
Fermor Avenue Crossing of Seine River		
Ferry Road	Portage Avenue	Ellice Avenue
Fort Street	Broadway	Portage Avenue
Fort Garry Bridges		
Garry Street	Broadway	Ellice Avenue
Gateway Road	Munroe Avenue	Chief Peguis Trail
Gladstone Street	Sutherland Avenue	Disraeli Street
Goulet Street	St. Mary's Road	Youville Street
Graham Avenue	Vaughan Street	Main Street
Grant Avenue	Pembina Highway	Roblin Boulevard
Grassie Boulevard	Lagimodiere Boulevard	Plessis Road
Hargrave Street	Broadway	Notre Dame Avenue
Harkness Avenue	Stradbrook Avenue	Mayfair Avenue
Henderson Highway	Disraeli Bridge	Glenway Avenue
Henderson Highway/ Talbot Avenue Interchange		
Hespler Avenue	Redwood Bridge	Henderson Highway
Higgins Avenue	Princess Street	Louise Bridge
Inkster Boulevard	Main Street	Brookside Boulevard
Isabel Street	Notre Dame Avenue	Logan Avenue
James Avenue	King Street	Main Street
Johnson Avenue	Henderson Highway	Levis Street
Jubilee Avenue	Osborne Street	Pembina Highway
Jubilee Overpass of Pembina Highway		
Keewatin Street	Notre Dame Avenue	Old Commonwealth Path
Kenaston Boulevard	Provincial Trunk Highway No. 100	St. James Bridge
Kenaston Boulevard/ St. James Bridge Interchange		
Kennedy Street	Cumberland Avenue	Ellice Avenue
Kennedy Street	Portage Avenue	Broadway
Kildonan Settlers Bridge		
King Street	Smith Street	Higgins Avenue
King Edward Street E.	St. Matthews Avenue	King Edward Street

<b>STREET</b>	<b>FROM</b>	<b>TO</b>
King Edward Street	King Edward Street E.	Oak Point Highway
King Edward Street Crossing of Omand's Creek		
Kintyre Street	St. James Bridge	Portage Avenue
Lagimodiere Blvd.	John Bruce Road	North City Limit
Lagimodiere Boulevard/ Concordia Avenue Interchange		
Lagimodiere Blvd. Overpass of CNR Reddit Subdivision		
Leila Avenue	Agnes Arnold Place	Main Street
Levis Street	Johnson Avenue	Watt Street
Levis Street	Nairn Avenue	Talbot Avenue
Logan Avenue	Disraeli Freeway	King Edward Street
Louise Bridge		
McGillivray Blvd.	Pembina Highway	Southwest City Limit
McGregor Street	Dufferin Avenue	Templeton Avenue
McMillan Avenue	Donald Street	Osborne Street
McPhillips Street	Notre Dame Avenue	North City Limit
Main Street	Assiniboine River	North City Limit
Main/Norwood Bridges		
Marion Street	St. Mary's Road	Lagimodiere Blvd.
Maryland Bridges		
Maryland Street	Notre Dame Avenue	Maryland Bridge
Mayfair Avenue	Harkness Avenue	Queen Elizabeth Way
Memorial Boulevard	York Avenue	Portage Avenue
Midtown Bridge		
Midwinter Avenue	Henderson Highway	Stadacona Street
Mission Street	Plinguet Street	Panet Road
Mountain Avenue	Main Street	McPhillips Street
Moray Street	North Bank of the Assiniboine River	Ness Avenue
Munroe Avenue	Henderson Highway	Gateway Road
Nairn Avenue	Stadacona Street	Panet Road
Nairn Overpass		
Ness Avenue	Sturgeon Road	St. James Street
Notre Dame Avenue	Portage Avenue	King Edward Street
Oak Point Highway	King Edward Street	Brookside Boulevard
Osborne Bridge		
Osborne Street	St. Mary Avenue	St. Vital Bridge
Pandora Avenue E.	Day Street	Ravenhurst Street
Partridge Avenue	Leila Avenue	Main Street
Pembina Highway	Osborne Street	South City Limit
Pembina Highway/ Bishop Grandin Blvd. Interchange		
Pembina Highway Crossing of La Salle River		
Pembina Highway/Jubilee Avenue Interchange		
Pioneer Avenue	Main Street	Provencher Bridge

<b>STREET</b>	<b>FROM</b>	<b>TO</b>
Plessis Road	P.T.H. 1 East	Grassie Boulevard
Portage Avenue	Main Street	St. Charles Street
Portage Avenue Crossing of Omand's Creek		
Portage Avenue Crossing of Sturgeon Creek		
Portage Avenue East	Westbrook Street	Main Street
Prairie Grove Road	St. Anne's Road	P.T.H. 59
Princess Street	Notre Dame Avenue	Higgins Avenue
Provencher Blvd.	Archibald rue	Provencher Bridge
Provencher Boulevard Crossing of Seine River		
Provencher Bridge		
Queen Elizabeth Way	Assiniboine River	Red River
Queen Street	Portage Avenue	Century Street Ramp
Ravenhurst Street	Pandora Avenue E.	Dugald Road
Redwood Avenue	Salter Street	Redwood Bridge
Redwood Bridge		
Regent Avenue	Panet Road	Day Street
River Avenue	Harkness Avenue	Wellington Crescent
River Road	St. Vital Road	St. Mary's Road
Riverton Avenue	Henderson Highway	Midwinter Avenue
Roblin Boulevard	Corydon Avenue	Provincial Trunk Highway No. 100
St. Anne's Road	St. Mary's Road	Forbes Road
St. James Bridges and Interchange		
St. James Street	Portage Avenue	Notre Dame Avenue
St. John Ambulance Way	Portage Avenue	Empress Street East
St. Mary Avenue	Main Street	Spence Street
St. Mary's Road	Red River	Red River Floodway
St. Vital Bridges		
Salter Street	Logan Avenue	Leila Avenue
Sargent Avenue	Ferry Road	Edmonton Street
Saskatchewan Avenue	P.T.H. 101	Sturgeon Road
Selkirk Avenue	McPhillips Street	Main Street
Shaftesbury Blvd.	Wilkes Avenue	Corydon Avenue
Sherbrook Street	Maryland Bridge	Logan Avenue
Silver Avenue	Sturgeon Road	Hamilton Avenue
Silver Avenue	Century Street	St. James Street
Slaw Rebchuck Bridge		
Smith Street	Midtown Bridge	Notre Dame Avenue
Spence Street	St. Mary Avenue	Portage Avenue
Stadacona Street	Louise Bridge	Talbot Avenue
Stafford Street	Pembina Highway	Academy Road
Sterling Lyon Parkway	Wilkes Avenue	McCreary Road/ Shaftesbury Boulevard
Stradbrook Avenue	Wellington Crescent	Queen Elizabeth Way
Sturgeon Road	Portage Avenue	North City Limit

<b>STREET</b>	<b>FROM</b>	<b>TO</b>
Sturgeon Road Crossing of Sturgeon Creek		
Tache Avenue	St. Mary's Road	Provencher Boulevard
Talbot Avenue	Riverton Avenue	Stadacona Street
Taylor Avenue	Pembina Highway	Kenaston Boulevard
Tim Sale Drive	Waverley Street	Waverley Street
Tuxedo Avenue	Kenaston Boulevard	Corydon Avenue
University Crescent	Pembina Highway	Chancellor Matheson Road
Vaughan Street	York Avenue	Ellice Avenue
Wall Street	Portage Avenue	Notre Dame Avenue
Warde Avenue	St. Mary's Road	St. Anne's Road
Waterfront Drive	Pioneer Avenue	York Avenue
Watt Street	CPR Keewatin Subdivision	Munroe Avenue
Waverley Street	Grant Avenue	Kenaston Boulevard
Waverley Street	Tim Sale Drive	Provincial Trunk Highway No. 100
Wellington Avenue	Winnipeg International Airport	Empress Street
Wellington Crescent	Academy Road	River Avenue
Westbrook Street	Water Avenue	Portage Avenue E.
Weston Street	Notre Dame Avenue	Logan Avenue
Westway	Empress Street	Empress Street E.
Wilkes Avenue	Waverley Street	Sterling Lyon Parkway
Wilkes Avenue	McCreary Road/Shaftesbury Boulevard	Provincial Trunk Highway No. 100
William Avenue	Main Street	McPhillips Street
William R. Clement Parkway	North Bank of the Assiniboine River	Grant Avenue
William Stephenson Way	Main Street	Provencher Bridge
York Avenue	Colony Street	Waterfront Drive
Youville Street	Goulet Street	Marion Street



Winnipeg

*Embrace the spirit • Vivez l'esprit*