

Temporary Conditions

D-1

CONSTRUCTION

WHEN

FLASHING

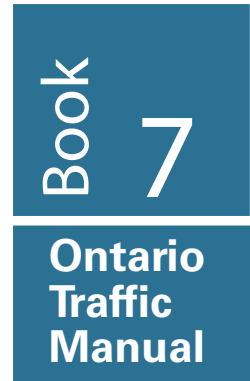

Temporary Conditions

Ontario Traffic Manual

January 2014

Cette publication hautement spécialisée (Ontario Traffic Manual – Volume 7) n'est disponible qu'en anglais en vertu du Règlement 671/92, qui en exempte la traduction selon l'application de la Loi sur les services en français. Pour obtenir des renseignements en français, veuillez communiquer avec le ministère des Transports de l'Ontario par courriel : otm@ontario.ca.

ISBN 978-1-4606-3505-6

Copyright © 2014

Queen's Printer for Ontario

All rights reserved.

Foreword

The purpose of the Ontario Traffic Manual (OTM) is to provide information and guidance for transportation practitioners and to promote uniformity of treatment in the design, application and operation of traffic control devices and systems across Ontario. The objective is safe driving behaviour, achieved by a predictable roadway environment through the consistent, appropriate application of traffic control devices. Further purposes of the OTM are to provide a set of guidelines consistent with the intent of the Highway Traffic Act and to provide a basis for road authorities to generate or update their own guidelines and standards.

The OTM is made up of a number of Books, which are being generated over a period of time, and for which a process of continuous updating is planned. Through the updating process, it is proposed that the OTM will become more comprehensive and representative by including many traffic control devices and applications specific to municipal use. Some of the Books of the OTM are new, while others incorporate updated material from the Ontario Manual of Uniform Traffic Control Devices (MUTCD) and the King's Highway Guide Signing Policy Manual (KHGSPM).

The OTM is directed to its primary users, traffic practitioners. The OTM incorporates current best practices in the province of Ontario. The interpretations, recommendations and guidelines in the OTM are intended to provide an understanding of traffic operations and they cover a broad range of traffic situations encountered in practice. They are based on many factors which may determine the specific design and operational effectiveness of traffic control systems. However, no manual can cover all contingencies or all cases encountered in the field. Therefore, field experience and knowledge of application are essential in deciding what to do in the absence of specific direction from the Manual itself and in overriding any recommendations in this Manual. The traffic practitioner's fundamental responsibility is to exercise engineering judgement and experience on technical matters in the best interests of the public and workers. Guidelines are provided in the OTM to assist in making those judgements, but they should not be used as a substitute for judgement. Design, application and operational guidelines and procedures should be used with judicious care and proper consideration of the prevailing circumstances.

In some designs, applications, or operational features, the traffic practitioner's judgement is to meet or exceed a guideline while in others a guideline might not be met for sound reasons, such as space availability, yet still produce a design or operation which may be judged to be safe. Every effort should be made to stay as close to the guidelines as possible in situations like these, and to document reasons for departures from them.

Custodial Office

Inquiries about amendments, suggestions or comments regarding the OTM or about training sources may be directed to:

Ministry of Transportation, Ontario

Traffic Office

301 St. Paul Street, 2nd Floor

St. Catharines, Ontario L2R 7R4

Email: otm@ontario.ca

Tel: (905) 704-2960

Fax: (905) 704-2888

A user response form is provided at the end of OTM Book 1. Inquiries regarding the purchase and distribution of this Manual may be directed to the custodial office. OTM Book 7 (Temporary Conditions) was developed with the assistance of a Stakeholder Advisory Committee organized by the Ministry of Transportation.

Acknowledgements

Technical Working Groups

Project Management/Technical Writing

Sharon Berg, Ministry of Transportation

Roger De Gannes, Ministry of Transportation

Tracey Difede, Ministry of Transportation

Jason Worrone, Ministry of Transportation

Project Consultant Team

Alireza Hadayeghi, CIMA

Brian Malone, CIMA

Hart Solomon, CIMA

Julie Johannis, JLM Studio

Kevin Piuino, JLM Studio

Nasim Mansour, CIMA

Pedram Izadpanah, CIMA

Serena Ma, Canada Editing

Sonya Kapusin, CIMA

Unplanned Events

Clifford Priest, Niagara Regional Police

Dan Ferguson, City of Mississauga

Joe O'Grady, Ministry of Labour

Marcel Lafantaisie, 407 ETR

Syd Best, Gazzola Paving Ltd.

Sheldon Crabb, Canadian Automobile Association

Terry Fredericks, Canadian Automobile Association

Typical Layouts

Alan Berry, Miller Paving Ltd.
 Andy MacKay, TWD Roads Management
 Bob Lane, Bot Construction Ltd.
 Bob Oddson, Carillion Canada Inc.
 Brian Peltier, TWD Roads Management
 Dave Norlock, TWD Roads Management
 Elton Culpeper, Carillion Canada Inc.
 Frank Nagy, Dufferin Construction Company - A division of Holcim (Canada) Inc.
 Jim Clark, Pioneer Construction Inc.
 Jim LaFontaine, Dufferin Construction Company - A division of Holcim (Canada) Inc
 John Kerfoot, Region of Waterloo
 Ken Lang, Steed and Evans Ltd.
 Ken Thomson, Carillion Canada Inc.
 Kent Dunham, Miller Paving Ltd.
 Marcel Lafantaisie, 407 ETR
 Peter Wehmeyer, Direct Traffic Management Inc.
 Syd Best, Gazzola Paving Ltd.
 Valerie Noyes, Ministry of Transportation

Review Committee

Dan Ferguson, City of Mississauga
 George Minow, Kitchener-Wilmot Hydro Inc.
 James Delamere, Stinson Equipment Ltd.
 Joe O'Grady, Ministry of Labour
 Kelly Schmid, Ministry of Transportation
 Peter Wehmeyer, Direct Traffic Management Inc.
 Shawn Aurini, Ministry of Transportation

Stakeholder Advisory Committee

Ontario Road Builders' Association
 Dennis O'Neil, Association of Ontario Road Supervisors
 Enzo Garritano, Infrastructure Health and Safety Association
 Frank Hull, Ontario Good Roads Association
 Gord Ough, Municipal Engineers Association
 Guy Taillon, Ministry of Labour
 Jeff Baker, Ministry of Transportation
 Marco Dangelo, Ontario Transportation Council
 Martin Petersons, Regional Municipality of Durham
 Milt Harmelink, Arges Training & Consulting
 Ralph Sholtz, Region of Niagara
 Rob Barr, International Signals Association
 Robert Norris, Toronto Police Services
 Rod Edwards, Arges Training & Consulting
 Russell Brownlee, Institute of Transportation Engineers

Table of Contents

| | | |
|------------|--|----------|
| 1.0 | Introduction | 1 |
| 1.1 | Purpose | 1 |
| 1.2 | Legal Authority | 2 |
| 1.3 | Application of Guidelines | 4 |
| 1.4 | How to Use This Book | 5 |
| 2.0 | Temporary Work Zone Design | 7 |
| 2.1 | Fundamental Principles of Work Zone Design | 7 |
| 2.2 | Defining the Roadway Environment | 9 |
| 2.3 | Configurations for Temporary Conditions | 11 |
| 2.3.1 | Off shoulder | 11 |
| 2.3.2 | Shoulder | 12 |
| 2.3.3 | Lane Encroachment | 12 |
| 2.3.4 | Partial Lane Shift(s) | 12 |
| 2.3.5 | Lane Closure(s) or Lane Occupied | 13 |
| 2.3.6 | Detours | 14 |
| 2.3.7 | Rolling Closures | 15 |
| 2.4 | Component Areas for Temporary Conditions | 16 |
| 2.4.1 | Advance Warning Area | 17 |
| 2.4.2 | Approach Area | 17 |
| 2.4.3 | Transition Area | 18 |
| 2.4.4 | Longitudinal Buffer Area (LBA) | 18 |
| 2.4.5 | Work Area | 19 |
| 2.4.6 | Termination Area | 19 |
| 2.4.7 | Additional Considerations in Component Area Design | 20 |
| 2.4.7.1 | Ingress and Egress | 20 |
| 2.4.7.2 | Linear Space Restrictions | 21 |
| 2.4.7.3 | Horizontal and Vertical Clearance | 22 |
| 2.5 | Duration of Work | 22 |
| 2.5.1 | Mobile Operations | 23 |
| 2.5.2 | Very Short Duration Work (VSD) | 23 |
| 2.5.3 | Short Duration Work (SD) | 24 |
| 2.5.4 | Long Duration Work (LD) | 24 |
| 2.6 | Road User Considerations | 25 |
| 2.6.1 | Speed Management in Temporary Work Zones | 25 |
| 2.6.2 | Pedestrian Safety Considerations | 29 |
| 2.6.3 | Cyclist Safety Considerations | 31 |

2.6.3.1 Directing Cyclists through the Work Zone 31

2.6.3.2 Cyclist Detours around the Work Zone. 33

2.6.3.3 Diversion of Cyclists onto Sidewalks 33

2.6.4 Night-time Provisions 34

2.6.5 Work Zone Lighting 35

2.6.5.1 Lighting of Work Area. 35

2.6.5.2 Roadway Lighting through a Work Zone 35

2.6.5.3 Anti-glare Screening 36

3.0 Description of Typical Traffic Control Devices 37

3.1 Devices for Channelization, Guidance and Information 37

3.1.1 Cones. 38

3.1.2 Construction Markers 38

3.1.3 Flexible Drums 38

3.1.4 Barricades 39

3.1.5 Barriers 39

3.1.6 Temporary Pavement Markings and Roadside Delineation 39

3.1.6.1 Orange Temporary Pavement Markings 40

3.1.6.2 Delineators 40

3.1.7 Signs 41

3.1.8 Dynamic Messaging Signs and Devices 43

3.1.8.1 Portable Variable Message Signs (PVMSs) 43

3.1.8.2 Flashing Arrow Board Signs (TC-12s) 44

3.1.8.3 Speed Display. 45

3.1.8.4 Supplementary Flashing Lights 45

3.1.8.5 Highway Advisory Radio (HAR). 46

3.1.8.6 Road Information Telephone Lines 47

3.2 Devices to Regulate/Control the Flow of Traffic 47

3.2.1 Traffic Control Persons (TCPs) 47

3.2.2 Temporary Traffic Control through the use of Signals. 48

3.2.2.1 Automated Flagger Assistance Devices (AFADs) 49

3.2.2.2 Portable Lane Control Signals (PLCS). 49

3.2.2.3 Portable Temporary Traffic Signals (PTTS). 50

3.2.2.4 Temporary Traffic Signals (TTS) 51

3.2.3 Pilot Vehicles 51

3.2.4 Pace Vehicles 52

3.2.5 Paid Duty Police Officers 52

3.3 Positive Protection Devices. 53

3.3.1 Buffer Vehicles and Longitudinal Buffer Areas 53

3.3.2 Glare Screens 54

| | | |
|------------|--|------------|
| 3.3.3 | Barriers | 54 |
| 3.3.3.1 | Temporary Concrete Barrier (TCB) | 55 |
| 3.3.3.2 | Moveable Barrier | 55 |
| 3.3.3.3 | Ballast Filled Barriers | 56 |
| 3.3.3.4 | Barrier End Treatments | 56 |
| 3.3.4 | Mobile Barriers | 57 |
| 3.3.5 | Vehicle Arresting Systems | 57 |
| 3.3.6 | Truck or Trailer Mounted Attenuators (TMAs) | 58 |
| 3.3.7 | Temporary Transverse Rumble Strips | 58 |
| 3.4 | Application of New Technologies | 58 |
| 4.0 | Implementation of Temporary Traffic Control | 63 |
| 4.1 | Preparation Before Beginning Work | 63 |
| 4.2 | Principles for Set Up and Removal of Traffic Control | 68 |
| 4.2.1 | Set up of Freeway Lane Closures | 71 |
| 4.2.1.1 | Freeway Closure of Single Right or Left Lane (with Shoulders) | 71 |
| 4.2.1.2 | Freeway Closure of Two Right or Left Lanes (with Shoulders) | 74 |
| 4.2.1.3 | Freeway Closure of One or Two Right or Left Lanes (No Shoulder on Roadway Side where Lanes are being Closed) | 77 |
| 4.2.2 | Removal (Take-down) of Freeway Lane Closures | 81 |
| 4.2.2.1 | Removal of Single Right or Left Lane Closure (Freeway with Shoulders) | 81 |
| 4.2.2.2 | Removal of Two Right or Two Left Lane Closure (Freeway with Shoulders) | 83 |
| 4.2.2.3 | Removal of Two Right or Two Left Lane Freeway Closure (No Shoulder on Roadway Side where Lanes are being Closed) | 85 |
| 4.3 | Inspection and Documentation | 87 |
| 5.0 | Specifications for Devices to Control the Flow of Traffic and Devices to Provide Positive Protection | 89 |
| 5.1 | Traffic Control With Moving Vehicles | 89 |
| 5.1.1 | Pilot Vehicles | 90 |
| 5.1.2 | Pace Vehicles | 91 |
| 5.1.3 | Rolling Closures | 93 |
| 5.2 | Use of Traffic Control Persons (TCPs) | 95 |
| 5.2.1 | Qualifications and Equipment | 96 |
| 5.2.2 | TCP Position and Location | 98 |
| 5.2.3 | TCP Control Procedures | 100 |
| 5.3 | Application of Signal Systems | 101 |
| 5.3.1 | Automated Flagger Assistance Devices (Remote Control Device) | 101 |
| 5.3.2 | Portable Lane Control Signals (PLCS) | 102 |

| | | |
|------------|---|------------|
| 5.3.3 | Portable Temporary Traffic Signals (PTTS) | 104 |
| 5.3.4 | Temporary Traffic Signals | 109 |
| 5.4 | Use of Paid Duty Police Officers | 114 |
| 5.5 | Implementation of Buffer Vehicles | 115 |
| 5.5.1 | Buffer Vehicle Required/Recommended Usage | 115 |
| 5.5.2 | Vehicle/Attenuator Requirements | 116 |
| 5.5.3 | Placement of Buffer Vehicles | 117 |
| 5.5.3.1 | Longitudinal Intrusions | 117 |
| 5.5.3.2 | Lateral Intrusions | 118 |
| 5.5.4 | Requirements for Freeway Zone Painting | 120 |
| 5.5.5 | Freeway Paving Operations | 120 |
| 5.6 | Temporary Concrete Barriers | 121 |
| 6.0 | Specifications for Channelizing, Information, and Guidance Devices | 123 |
| 6.1 | Cones, Markers, Flexible Drums and Barricades | 123 |
| 6.2 | Temporary Pavement Markings | 126 |
| 6.2.1 | Orange Temporary Pavement Markings | 128 |
| 6.2.2 | Delineators | 129 |
| 6.3 | Traffic Control Signs | 130 |
| 6.3.1 | Sign Size | 130 |
| 6.3.2 | Sign Reflectivity Standards | 131 |
| 6.3.3 | Sign Material and Thickness | 132 |
| 6.3.4 | Positioning and Installation of Signs | 133 |
| 6.3.5 | Individual Sign Specifications – Static Message Signs | 136 |
| 6.3.6 | TC-12 Flashing Arrow Board Sign | 168 |
| 6.3.7 | Portable Variable Message Signs (PVMSs) | 171 |
| 6.3.7.1 | Physical Specifications | 171 |
| 6.3.7.2 | Site Selection and Installation of PVMS | 174 |
| 6.3.8 | Message Guidelines | 175 |
| 7.0 | Quality Replacement Guidelines for Traffic Control Devices | 179 |
| 7.1 | Quality Guidelines | 179 |
| 7.2 | Evaluation Guide | 180 |
| 7.2.1 | Work Zone Signs | 181 |
| 7.2.2 | Flexible Drums (TC-54 Barrels) | 182 |
| 7.2.3 | Cones | 183 |
| 7.2.4 | TC-12 Flashing Arrow Boards | 183 |
| 7.2.5 | Variable Message Signs (VMS) | 184 |
| 7.2.6 | Pavement Tape and Paint | 184 |
| 7.2.7 | Temporary Raised Pavement Markers (TRPMs) | 184 |

| | | |
|-------------|---|------------|
| 7.3 | Monitoring of Contractor Compliance | 184 |
| 8.0 | Typical Layouts For Signing Temporary Work Zone Situations | 185 |
| 8.1 | General Notes to Typical Layouts: | 197 |
| 8.1.1 | Legend of Symbols used in the Typical Layouts | 200 |
| A1-1 | Appendix 1: Temporary Traffic Control for Unplanned Events. | 243 |
| A1-1 | Introduction. | 243 |
| A1-1.1 | Scope. | 243 |
| A1-1.2 | Definition of Unplanned Events | 245 |
| A1-1.3 | Traffic Control Guidelines | 245 |
| A1-1.4 | Unified Command | 247 |
| A1-2 | Guidelines for First on Scene | 247 |
| A1-2.1 | Identification of Hazards and Scene Evaluation | 247 |
| A1-2.2 | Estimated On-scene Time – Extended Duration Scene | 248 |
| A1-2.3 | Lane Closure and Traffic Direction. | 248 |
| A1-3 | Equipment and Devices | 249 |
| A1-3.1 | High Visibility Safety Apparel | 249 |
| A1-3.2 | Vehicle Lights and Flares | 250 |
| A1-3.3 | Emergency Signs | 251 |
| A1-3.4 | Traffic Cones | 252 |
| A1-3.5 | Manual Traffic Direction | 253 |
| A1-3.6 | Other Available Traffic Control Devices. | 253 |
| A1-4 | Placement of Cones/Flares | 255 |
| A1-5 | Positioning of Emergency Response Vehicles | 258 |
| A1-6 | Situations that Require Special Attention | 259 |
| A1-7 | Progression of Traffic Control. | 260 |
| | Appendix 2: Glossary | 264 |
| | Appendix 3: References. | 293 |

Figures

| | | |
|-----------|--|-----|
| Figure 1 | Component Areas. | 16 |
| Figure 2 | Conditions that Affect Traffic Control Requirements | 67 |
| Figure 3 | Freeway Closure of Single Right or Left Lane (with Shoulders) | 73 |
| Figure 4 | Freeway Closure of Two Right or Left Lanes (with Shoulders). | 76 |
| Figure 5 | Freeway Closure of Two Right or Left Lanes (No Shoulder on Roadway Side where Lanes are being Closed). | 80 |
| Figure 6 | Removal of Single Right or Left Lane Closure (Freeway with Shoulders). | 82 |
| Figure 7 | Removal of Two Right or Two Left Lane Closure (Freeway with Shoulders) | 84 |
| Figure 8 | Removal of Two Right or Two Left Lane Closure (No Shoulder on Roadway Side where Lanes are being Closed). | 86 |
| Figure 9 | Traffic Control Person Use of STOP/SLOW Paddle. | 97 |
| Figure 10 | Positioning of Traffic Control Persons | 99 |
| Figure 11 | Portable Lane Control Signal. | 103 |
| Figure 12 | Signal Timing Calculations Example | 110 |
| Figure 13 | Buffer Vehicles and LBA Scenarios | 119 |
| Figure 14 | Typical Sign Placement | 134 |
| Figure 15 | Work Zone Signs Quality Illustration | 181 |
| Figure 16 | Flexible Drums (TC-54 Barrels) Quality Illustration | 182 |
| Figure 17 | Cones Quality Illustration | 183 |

Tables

| | | |
|---------|--|-----|
| Table 1 | Posting of Reduced Speed Limits in Construction Zones: Appropriate Use of Advisory or Regulatory Speed Limit Signs | 27 |
| Table 2 | Traffic Control Person Placement (TCP Table). | 100 |
| Table 3 | Signal Visibility Table | 104 |
| Table 4 | Service Volume at Signalized Single Lane Construction Sites (Vehicles per Hour – One Way) | 112 |
| Table 5 | Vehicle Arrival Rates and Green plus Amber Times (Level of Service “E”) | 113 |
| Table 6 | Minimum Dimensions of Work Zone Warning Signs | 131 |
| Table 7 | Minimum Reflectivity Requirements | 132 |
| Table 8 | Standard Sign Blank Descriptions (MTO) | 133 |
| Table A | Work Zone Component Dimensions: Very Short and Short Duration Work (Non-freeways) | 186 |
| Table B | Work Zone Component Dimensions: Long Duration Work (Non-freeways) | 187 |
| Table C | Work Zone Component Dimensions: Freeways | 188 |
| Table D | Application of Longitudinal Buffer Area and Lateral Intrusion Deterrence Gap. | 189 |
| Table E | Typical Usage of Signs through a Temporary Work Zone | 190 |
| Table F | Usage of Channelizing Devices, Barricades, and Barriers | 192 |
| Table G | Decision Matrix: Typical Layouts | 193 |

Signs and Devices

Traffic Cones 123

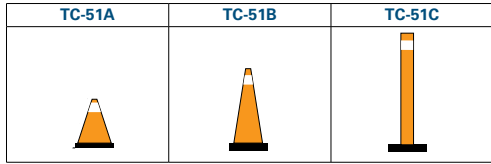

Construction Marker 124

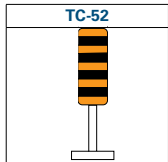

Flexible Drum (Barrel) 125

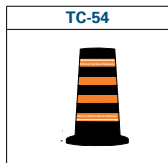

Barricades 126

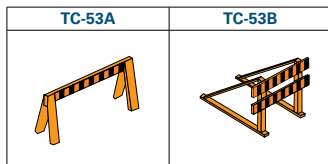

Construction Ahead Signs 137



Road Work Signs 138



Lane Closed Ahead Signs 139

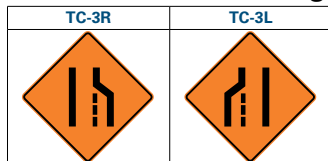

Lane Closed Tab Signs 139

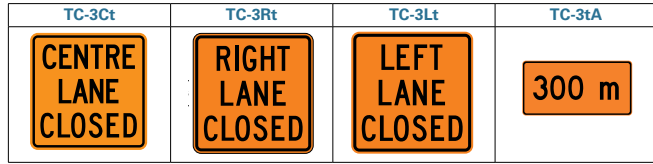

Lane Closure Arrow Signs 140

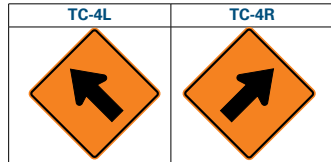

Detour Ahead Signs 141

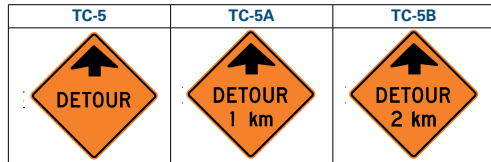

Detour-Turn Off/Diversion Signs 142

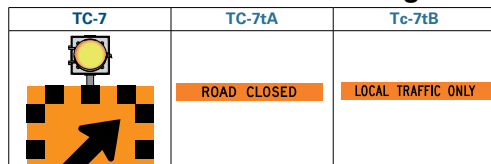

Roadside Diversion Warning Signs 143

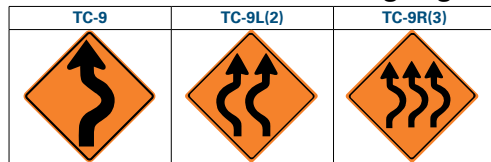

Detour Designation Signs 144

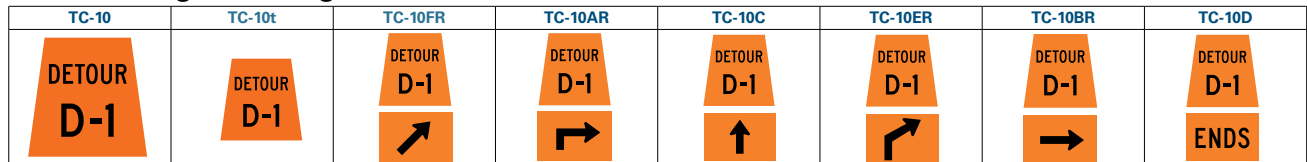

Narrow Lanes Sign 145

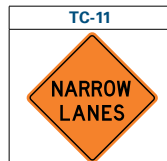

Trucks Use Centre Lane Tab Signs 145

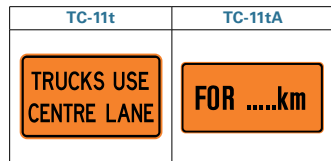

Pavement Ends Sign 146

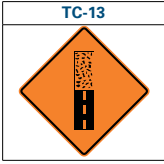

Bump Ahead Signs 146

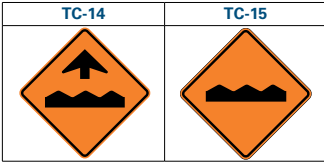

Turn and Curve Signs 147

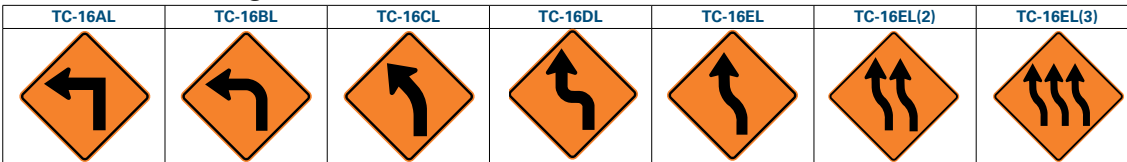

Advisory Speed Tab Sign 148



Chevron Alignment Sign 148



Grooved Pavement Signs 149

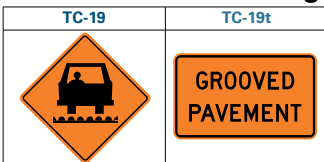

Prepare to Stop Signs 149

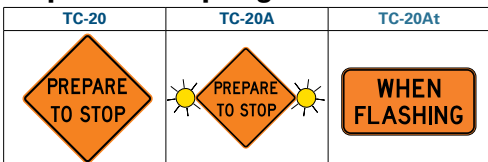

Traffic Control Person (TCP) Ahead Sign 150

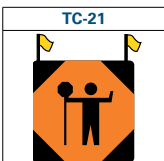

Traffic Control Sign (Stop/Slow Paddle) 151

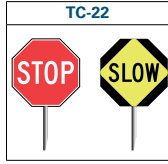

Signals Ahead Sign 151

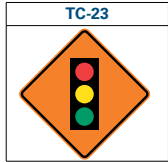

Remote Control Device Ahead Signs 152

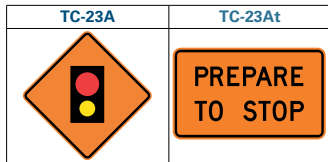

Uneven Lanes Sign 152

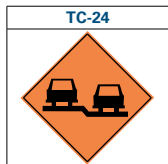

Do Not Pass When Flashing Sign 153

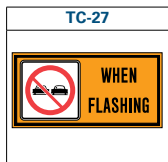

Truck Entrance Signs 153

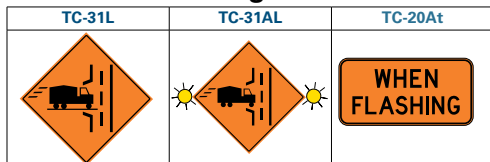

Temporary Bridge Signs 154



Low Bridge Ahead Signs 155

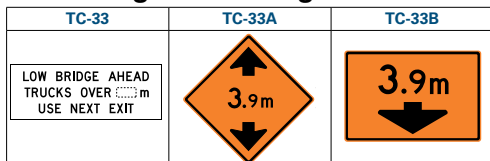

Two-Way Traffic Sign 156

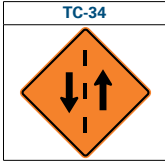

Ramp Closed Ahead Sign 156

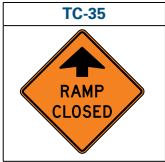

Maximum Speed Advisory Sign 157

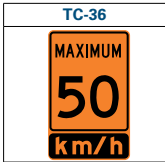

Soft Shoulders Sign 157

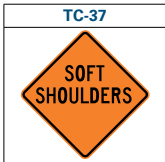

No Exit Sign 158



Pedestrian Direction Sign 158

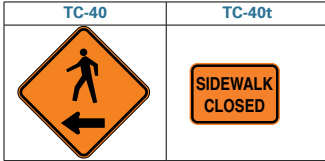

Lane Designation Direction Sign 159

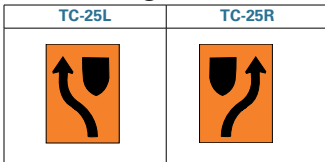

Speed Fines Speed Fines Doubled Sign 159

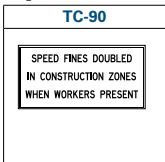

Construction Zone Signs 160

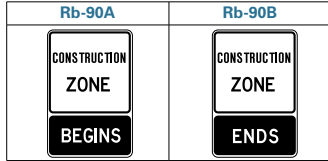

Yield Sign 160

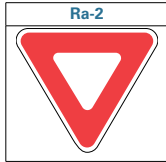

Yield To Oncoming Traffic Sign 161

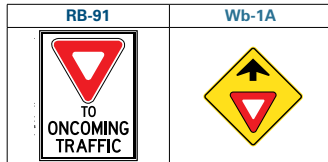

Do Not Use Radio Transmitter Signs 162

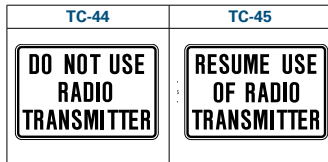

Road Closed Sign 162

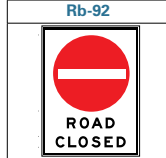

New Roadway Open Sign 163

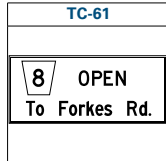

Alternate Highway Route Sign 163

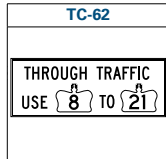

Road Closing/Restriction Notice Sign (Full-Time) 164

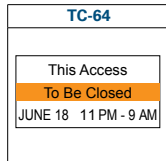

Road Closing Notice Sign 164

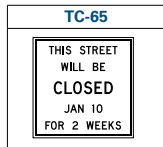

Highway Section Closed Sign (Advance) 164

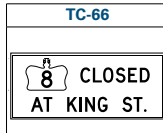

Street Section Closed Sign (Advance) 165

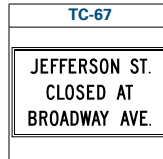

Contract Identification Sign (Joint project) 165

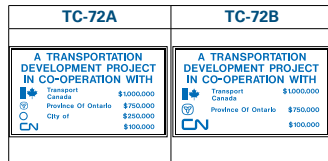

Contract Identification Sign 166

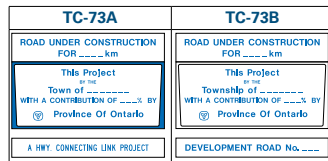

Contract Identification Sign (Municipal Project) 166

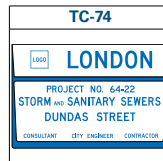

Contractors Identification Sign 167

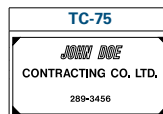

Contract Information Signs 167

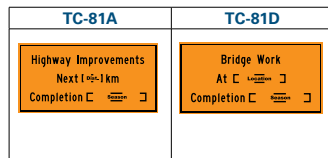

Flashing Arrow Board Sign 168

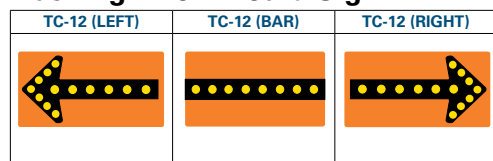

1

Introduction

Book 7 - Temporary Conditions (Office and Field edition) is one of a series of volumes that makes up the Ontario Traffic Manual (OTM). The 2013 version of OTM Book 7 is a update to the March, 2001 edition.

OTM Book 7 addresses the application of traffic control devices in temporary “work zones” that result from construction (including pre-engineering) planning, surveying, maintenance, utility, unplanned event response or other work within a public road allowance. It should be read in conjunction with OTM Book 1 (Introduction to the OTM) and its three appendices, which provide guidelines on the design and application of traffic control signs, signals, markings, and delineation devices.

OTM Book 7 is not intended to provide sufficient detailed information for the design and fabrication of individual signs. For these purposes, reference should be made to OTM Book 2 (Sign Design, Fabrication and Patterns), and OTM Book 3 (Ground Mounted Sign Support and Installation). Where French language or bilingual versions of signs are available, they have not been illustrated in OTM Book 7, but are contained in OTM Book 2 (Sign Design, Fabrication and Patterns).

Other Books in the OTM series provide practical guidance on a full range of traffic control devices and their applications. A complete listing of the planned and current volumes is available from the Ministry of Transportation Ontario (MTO).

Other documents, not in the OTM series, are also useful. The Ontario Geometric Design Manual and the Ontario Roadside Safety Manual also provide guidance in the design of temporary conditions.

1.1

Purpose

OTM Book 7 - Temporary Conditions has been developed to provide basic uniform guidelines for traffic control in temporary work zones on or adjacent to public highways, including ramps and municipal roads and streets, as well as other public ways to which road traffic has access. OTM Book 7 is intended for use by the following agencies and organizations:

NOTE

Book 7 provides uniform guidelines for traffic control in temporary work zones.

NOTE

Safety in road work zones depends on the application of a number of key elements which must work together as a system or a “safety chain”, which is only as strong as its weakest link.

(1) provincial, municipal, and private road authorities in Ontario and their contractors, and

(2) utilities, contractors, and others who may have approval to work on public roadways.

Safety for workers and road users is paramount, especially workers who set up, operate, and remove traffic control measures. The purpose of this book is to provide current best practices for traffic control to be adhered to for work on MTO highways. As well, individuals or agencies who perform work on any street or highway open to the public in the province of Ontario should also follow these fundamental principles and guidelines to achieve satisfactory levels of safety for workers and road users.

Safety in road work zones depends on the application of a number of key elements which must work together as a system or a “safety chain”, which is only as strong as its weakest link. If a key element is weak or absent, safety may be compromised. These elements include:

- design of the road, construction or maintenance plan, and staging;
- traffic control plan that identifies all necessary elements;
- traffic protection plan for the protection of workers;
- training of all personnel involved in traffic control, and/or working on a roadway;
- contractor compliance with traffic control and traffic protection plans, including safe installation, application, and removal of all necessary traffic control elements;
- quality assurance checks of contractor compliance with traffic control plan, with appropriate consequences for non-compliance;
- safe work habits on the part of workers; and
- appropriate police enforcement.

1.2 Legal Authority

The Ministry of Labour, through the Occupational Health and Safety Act (OHSA) and Regulations for Construction Projects, R.S.O. 1990 and R.R.O. 213/91 as

amended by 631/94 and 145/00, and as amended from time to time thereafter, has the legal authority to regulate the safety of workers. This includes protection measures for all workers, including requirements related to traffic control persons (TCPs) who direct traffic through or around a road construction site. The OHS and Regulations take precedence over OTM Book 7 in matters of worker safety.

The MTO, through the Highway Traffic Act (HTA), Public Transportation and Highway Improvement Act, and various related statutes, has the legal authority and responsibility to regulate and control traffic on a highway and regulate and control motor vehicles that operate in the province. Municipalities, through the Municipal Act and various regional municipality acts, and as empowered to enact municipal by-laws through various provisions of the HTA and other provincial acts, have the legal authority and responsibility to regulate and control traffic on their highways. The authority and responsibility also apply to construction and maintenance activities on highways.

Traffic signs, pavement markings, traffic control signals, and other devices to regulate, warn, or guide traffic are to be installed only under the authority of the road agency which has jurisdiction. **When they have been authorized**, contractors, utility companies, or others may install temporary condition signs and devices, or use qualified TCPs to protect road users, the public, workers, and equipment, subject to the guidelines of this manual, the OHS and its regulations, and the requirements of the road authority. Where other legislation exists allowing access, requirements of the HTA must still be met and co-operation between the road authority and utilities provides the best protection for workers and the public.

Contractors may be authorized by the road authority to slow upstream traffic (e.g., rolling closures). The contractor may also implement short-term road closures, as authorized by the road authority. It is the road authority's decision whether to use contractor staff or police for these operations.

Regulatory devices may need to be supported by applicable legislation, regulations, or by-laws. Effective traffic control requires both the appropriate application of traffic control devices and reasonable, effective enforcement.

NOTE

The OHS and Regulations take precedence over OTM Book 7 in matters of worker safety.

NOTE

Work must not commence without first obtaining a work permit or the approval of the road authority concerned.

1.3 Application of Guidelines

The standard use of traffic control devices is illustrated in OTM Book 7 for typical and common situations. It is difficult to illustrate detailed guidelines for all situations that may arise. Hills, curves, intersections, driveways, other physical features and adverse weather conditions may require variations from the guidelines as illustrated. However, all temporary conditions installations must conform to the general principles presented in OTM Book 7. Judgement must be used to select the appropriate devices and placement that will provide an equivalent or higher level of protection to both workers and road users. Required protection should be determined on the basis of traffic speeds, vehicle and pedestrian volume, sight distance, duration of operation, and exposure to hazards. The traffic engineer or road superintendent of the road authority should be consulted for guidance in unique traffic control circumstances. Where significant deviation from OTM Book 7 is deemed necessary Regional Traffic Office approval is required for work on MTO highways. Any deviations from the guidelines in OTM Book 7 should be documented, along with the reasons for the deviations. Where messages are required other than those provided, signs should be the same shape as standard signs of the same classification, and in the colours described in Table 1 (Shape and Colour Codes for Signs) of OTM Book 1, and [Section 6](#) of OTM Book 7. Signs and other devices should be designed to be recognizable and comprehensible at a glance. Uniformity and simplicity in design, position, and application are of the greatest importance in aiding recognition. Traffic devices and supports must not bear any unauthorized or non-standard labels, logos, or commercial advertising on the face of the sign.

Uniformity in traffic control layouts and device usage will increase worker and road user safety. Therefore it is highly recommended that the guidelines for temporary conditions outlined in OTM Book 7 be adopted by all public authorities and private companies and contractors with safety responsibilities in construction, maintenance, utility, and other work on public highways and streets. Instructions must be given to all employees and contractors, and the guidelines should be included or referenced in the specifications for all contracts. Road authorities may have additional typical layouts and conditions for local requirements.

1.4 How to Use This Book

NOTE

OTM Book 7 is used by different stakeholders, including provincial, municipal, and private road authorities, contractors, utilities, designers, and enforcement officers. Both current and new users primarily refer to OTM Book 7 to:

- understand guidelines for traffic control in temporary conditions;
- evaluate temporary conditions and determine the required traffic control;
- set up, deploy and remove traffic control devices;
- evaluate compliance of traffic control devices on site; and
- introduce new technologies, where appropriate.

OTM Book 7 has been organized under the following sections:

Section 1 provides an overview of OTM Book 7 with guidance on how to use the book.

Section 2 describes the fundamental principles of traffic control design for temporary conditions. This section is intended to assist both current and new users in understanding the guidelines provided throughout OTM Book 7. This section also provides the definitions necessary to assist users in the proper interpretation of typical layouts (e.g., freeway, partial lane shift, short duration). The definitions provided will be of particular interest to users who are required to either modify a typical layout or develop a new typical layout for a unique situation.

Section 3 describes in general, the devices used for traffic control in temporary conditions and their typical applications. This section will assist both current and new users in understanding the application of traffic control devices identified in OTM Book 7. Specifically, this section will assist users in understanding the devices that are available and thus aid in their preliminary selection of traffic control devices. The information provided will be of particular interest to users who are required to either modify a typical layout or develop a new typical layout for a unique situation, which may require additional or alternate devices. An explanation of the requirements to introduce a new technology (including trials by a road authority) is also included in this section.

NOTE

Section 4 provides guidelines for the preparation, set up, deployment, and removal of devices. This section describes what to do during the temporary condition and is to be used by any person who is physically providing or setting up traffic control.

Section 5 provides the specifications for flow control and positive protection traffic control devices when used on MTO highways. This section is to be used once devices have been identified based on the fundamental and guiding principles described in Sections 1 through 4, and/or through a typical layout. Section 5 is particularly relevant to designers, contractors, and road authorities in preparing or ordering a schedule of devices, persons who are deploying the devices in reference to typical layouts, and supervisors or enforcement officers in evaluating the compliance of devices on site.

Section 6 provides the specifications for channelizing, guidance and information traffic control devices when used on MTO highways. This section is to be used once devices have been identified based on the fundamental and guiding principles described in Sections 1 through 4, and/or through a typical layout. Section 6 is particularly relevant to designers, contractors and road authorities in preparing or ordering a schedule of devices, persons who are deploying the devices in reference to typical layouts, and supervisors or enforcement officers in evaluating the compliance of devices on a site.

Section 7 provides guidelines for the evaluation of the quality of installed devices to determine whether they still meet the specifications in Sections 5 and 6. This section is intended for supervisors, workers and enforcement officers when evaluating the compliance of devices on a site.

Section 8 demonstrates where to place traffic control devices with reference to tables for the relative location and spacing of devices and lengths of the component areas. Typical layouts for basic scenarios are illustrated here. The section is to be used by any individual who is modifying a typical layout or developing a new typical layout for a unique situation (by using the tables for design), any person who is deploying the devices as per the typical layouts, or any person who is evaluating temporary conditions and determining the required traffic control.

2

Temporary Work Zone Design

Section 2 outlines the fundamental principles of work zone design, explains terminology for defining the section of roadway and temporary configuration, and outlines work zone design considerations for road users. The information contained in this section is intended to assist the reader in understanding the guidelines presented in OTM Book 7 and evaluating situations that are either not explicitly demonstrated in the typical layouts or require sound engineering judgement. The definitions provided will be of particular interest to users who are required to either modify a typical layout or develop a new typical layout for a unique situation.

2.1

Fundamental Principles of Work Zone Design

Risk to road users and workers can be reduced by providing a predictable and familiar roadway environment. Consistent and appropriate application of traffic control devices throughout all work zones will increase the probability of road users exhibiting desired behaviours.

Roadway work zones should be designed around the following basic principles:

- worker safety;
- road user (motorist, pedestrian/cyclist, and others) safety;
- road user mobility;
- advance warning (provision of advance notice to road users that they are approaching a work zone);
- work site identification (visible identification of the work area by passive and/or active traffic control devices to show road users where work is taking place); and
- positive guidance (provision of information to road users required to avoid hazards, when and where this information is needed, in a form that can best be used). See also OTM Book 1c (Positive Guidance Toolkit).

These basic principles must be explicitly designed into construction, maintenance or other projects on a public highway, rather than applied on a makeshift basis.

NOTE

Section 2 provides the principles for design and modification of traffic control layouts.

Risk to road users and workers can be reduced by providing a predictable and familiar roadway environment.

NOTE

A traffic protection plan must be prepared in advance for any construction project.

All traffic control devices for temporary conditions must be removed when no longer needed.

The designer should ensure that:

- **Traffic movement is interfered with or inhibited as little as possible.**
Frequent or unnecessary changes in the roadway configuration that might lead to risky manoeuvres should be avoided, such as sudden lane narrowings, lane closures or reductions in speeds. Special precautions must be taken to ensure that construction equipment can be safely operated without making it hazardous to passing traffic. Roadway occupancy and work completion time should be minimized to reduce exposure to potential hazards.
- **A good public information campaign is undertaken for long duration operations.**
Road users should be provided with accurate and up-to-date information on the existence of work sites, their status and reasons for them.
- **Adequate and consistent traffic control devices are provided.** Road users must be guided in a clear and positive manner by adequate signs, channelizing devices, pavement markings, traffic signals, or traffic control persons (TCPs), whichever control device/measure or combination of control devices/measures is most appropriate. On MTO highways approval is required for the use of any traffic control device(s) not shown in OTM Book 7 including the use of non-standard combinations or configurations of otherwise standard devices.
- **The plan for worker safety is communicated.**
A traffic protection plan must be prepared in advance for any construction project, in conformity with the policies and guidelines of the governing road authority and Ministry of Labour requirements. The plan must be communicated to workers in a language they can understand. Workers must also be knowledgeable of general principles of work zone safety, such as where work vehicles are present, workers should stay ahead of (downstream of) the vehicle, not behind (upstream of) the vehicle whenever practicable.
- **Traffic controls are continually monitored and updated.**
Individuals engaged in traffic control must regularly check the traffic control elements to ensure that the traffic operations in the work zones are acceptable. The elements and devices of the traffic control system should be regularly monitored to ensure that they remain in place, are visible as intended and undamaged. The individuals engaged in traffic control must also carefully check the work sites to make sure that traffic controls are continually updated to suit changing conditions due to work staging and progress. Work zone traffic controls must reflect actual conditions, so that

signage is credible, which increases the likelihood of driver compliance. All traffic control devices for temporary conditions must be removed when no longer needed. When work is suspended for short periods of time, advance warning signs that are no longer appropriate must be removed, covered or turned, and other inappropriate devices must be removed from the work area so they are not visible to road users.

NOTE

2.2 Defining the Roadway Environment

Application of the guidelines provided in OTM Book 7 typically requires defining the roadway section affected by the temporary condition:

- **As a freeway or non-freeway**

A freeway is defined as a multi-lane divided highway with a continuous dividing median (demarcated by more than pavement markings), full control of access and interchanges in place of at-grade intersections, and a normal posted regulatory speed (NPRS) of 90 km/h or greater. This term includes all 400 series divided highways and toll highways built to a freeway configuration, and all freeway speed transition zones where the speed limit has been reduced approaching the end of the freeway and other areas where speed reductions are in place due to geometrics such as curves or freeway to freeway ramps. If the section of roadway within the limits of the designated construction zone does not match all of these criteria, then it is a non-freeway. For purposes of traffic control, road authorities may designate some high volume and/or high speed non-freeways as freeways.

For purposes of traffic control, road authorities may designate some high volume and/or high speed non-freeways as freeways.

- **By the cross section of a roadway**

Guidelines are provided for two-lane and multi-lane cross sections. Multi-lane cross sections can be divided or undivided.

- **By the configuration of temporary conditions**

Configurations of temporary conditions may include off shoulder, shoulder, lane encroachment, partial lane shift(s), lane closure(s), detour, or rolling closure as defined in [Section 2.3](#).

- **By the duration of work that is being done**

The duration of work can be defined as mobile, very short, short, and long, as defined in [Section 2.5](#).

The general guidelines provided in OTM Book 7 are applicable to all roadways. However, the differences between roadway environments may warrant some

NOTE

separate treatment of temporary traffic control. Examples of roadway environments include:

- **low volume and high volume roadways**

For temporary conditions, low volume roads are defined as those with a combined traffic volume in both directions of less than 3000 vehicles per day. Conversely, high volume roads are those with a combined traffic volume of 3000 vehicles per day or more. High volume roads require greater traffic flow control. Low volume roads often experience higher observed speeds. Typical layouts include accommodation, where applicable, for low and high volume environments. Volume assessments should include volume variation with time of day and consider the impact to traffic control requirements;

- **urban arterial environments**

Urban environments are typically characterized by limited manoeuvring space, frequent turns and cross movements, need for pedestrian and cyclist protection, and prevalence of street furniture and buildings. Typical problems encountered are cluttering of signs, lack of shoulders/available space for placement of signs, non-compliance by road users, and short spacing between streets. The following alternatives may be considered (see also [2.4.7.2 Linear Space Restrictions](#)):

- Use larger or additional signs if space permits, on wide streets with high traffic speeds and volumes, especially when advertising displays and distracting backgrounds compete with standard sized warning signs for motorist attention.
- The required advance distances for the placement of warning signs, shown in OTM Book 7 Typical Layouts, must be adhered to as closely as practicable, but may have to be reduced where there are frequent driveways and short block lengths. Where such distances are reduced, active control devices such as flashing arrow boards and/or changeable message signs should be considered.
- Recommended taper length might not be possible in an area of the city with many driveways and entrances. This may be offset by the additional use of traffic control devices, such as a TC-12 flashing arrow board or reduced barrel spacing.
- Where there are high volumes and expected long delays, additional notification signs are to be installed prior to work being done.
- If visibility is limited by a horizontal or vertical curve or other roadside obstacles, additional signage should be provided and/or a taper might be lengthened (beyond the length shown in typical layouts) so as to give drivers adequate warning and visibility of the start of the taper;

- **rural two-lane environments**

Rural two-lane environments are typically characterized by long trip distances, rare congestion, few alternate routes, sparsely spaced driveways/crossing roadways, minimal development adjacent to the roadway, primarily a natural or agricultural environment with increased presence of wildlife. In addition, many travellers may be unfamiliar with their surroundings. The following alternatives may be considered:

- Place additional advance warning signs ahead of the expected/observed end of queue resulting from temporary condition. Consider any limited visibility due to a horizontal or vertical curve.
- Wear higher reflectivity clothing.
- Use enhanced lighting on TC-22 to increase visibility.
- Use of more active devices.
- Use operating speed instead of normal posted regulatory speed (NPRS) as the criteria for traffic control layout.

NOTE

2.3 Configurations for Temporary Conditions

Configurations for temporary conditions include varying degrees of complexity and levels of intrusion, and can be categorized as:

- off shoulder;
- shoulder;
- lane encroachment;
- partial lane shift(s);
- lane closure(s);
- detour; or
- rolling closure.

2.3.1 Off shoulder

Off shoulder work is work within the right of way, but completely beyond the shoulder of the road, such that workers, equipment, or vehicles (including parked vehicles) do not encroach onto the shoulder.

Off shoulder work requires no traffic control devices. Where a shoulder is not clearly defined, the work can be considered off shoulder if the work area, including all work ve-

NOTE

Lane encroachment is not recommended on freeways.

Partial lane shifts must not be used where posted speeds are 90 km/h or higher.

Narrowed lanes are used for multi-lane roads where posted speeds are higher than 80 km/h.

hicles and equipment, is beyond 3.0 m from the edge of pavement. On MTO highways off shoulder work should comply with the Roadside Safety Manual.

2.3.2 Shoulder

Shoulder work is where workers, vehicles, and equipment are on the shoulder, but do not encroach into the travelled lanes.

The following are typical layouts for reference purposes: [TL-5](#), [TL-6](#), [TL-11](#), [TL-12](#).

2.3.3 Lane Encroachment

Lane encroachment is where workers, vehicles, or equipment are partially within the travelled lane, but there is at least 3.0 m (3.5 m for freeways) in width of useable lane for traffic.

Except where required for some maintenance mobile operations, lane encroachment is not recommended on freeways.

The following are typical layouts for reference purposes: [TL-7](#), [TL-8](#), [TL-14](#), [TL-66](#).

2.3.4 Partial Lane Shift(s)

A partial lane shift is where more than one lane is temporarily realigned. This is used when the encroachment of roadside operations will result in a traffic lane width of less than 3.0 m; however, squeezing all lanes minimally will provide lane widths that are at least 3.0 m for each lane.

Partial lane shifts can be used for short work areas (up to 50 m) where visibility is good.

On two-lane roads partial lane shifts may be used where the NPRS is:

- 60 km/h or lower (low- and high-volume roads); and
- 70 km/h or higher (low-volume roads only).

Partial lane shifts must not be used where NPRS are 90 km/h or higher.

On multi-lane roads where the NPRS is 90 km/h or higher, lane shifting is achieved through the use of narrowed lanes (TL-17) and must not be demarcated only

through the use of cones. Lane widths should be at least 3.5m for freeways. Lane shifting is to be achieved through the use of one or more of the following:

- temporary concrete barriers (TCBs) to provide work area protection;
- construction markers or barrels for tapers; and/or
- temporary pavement markings for lane demarcation, along with removal of existing pavement markings.

Partial lane shifting should typically only occur within the hard-surface of a roadway. Where motorists need to be directed onto the gravel shoulder of a roadway a posted speed reduction is required. When a lane shift is required on an all-gravel surfaced roadway, vehicles should not be directed off the roadway onto a shoulder that is soft or has a different texture. The abilities of vulnerable road users such as motorcycles, cyclists and pedestrians should be considered when a lane is shifted onto an unpaved surface.

Partial lane shifting avoids the closure of one lane and the use of TCP(s). However, additional care must be taken for worker safety in setting up and removing the cones or barrels that demarcate the shifted lanes.

Higher speeds require more advance notice and a more gradual transition, with an appropriate taper length in advance of the lane shift.

Lane shifts are generally less than 1.0 m. Lane shifts that are more than 1.0 m on a typical two-lane road will only rarely occur, as this would create lane widths of less than 3.0 m, in which case a lane closure must be used. Lane shifts that are more than 1.0 m can occur on two-lane roads with parking spaces on one or both sides, but the parking is to be temporarily removed, and the parking area is instead occupied by a shifted lane.

The following are typical layouts for reference purposes: [TL-9, TL-10 and TL-17](#).

2.3.5 Lane Closure(s) or Lane Occupied

A lane closure is when a travelled lane(s) is closed off and traffic is redirected.

Lane closures must be used when roadside operations result in lane widths less than 3.0 m (3.5 m for freeways) or when operations occupy a travelled lane.

The following are typical layouts for reference purposes: [TL-16, TL18-39, TL42-63](#)

NOTE

Partial lane shifts can avoid the use of TCP(s).

NOTE

Guidance of traffic through detours requires signage that is continuous and complete.

2.3.6 Detours

A detour is when traffic is diverted from its normal path because it cannot be adequately accommodated within an existing roadway. Guidance of traffic through detours requires signage that is continuous and complete to guide drivers back to the normal route.

Types of detours include:

- **roadway diversion**
Traffic in both directions is required to make a short diversion, within the highway right of way, to bypass the work area;
- **lane realignment**
Traffic in one direction is diverted from its normal path onto an alternate alignment around a temporary work area; and
- **route detour**
Traffic is required to completely depart from the normal route and directed to use alternate roads. A route detour is typically provided when the road capacity is reduced to the point to which some of the traffic must be redirected due to excessive delays, or the road is entirely closed at which point an alternate route must be provided. The alternative route will be signed by using a combination of appropriate TC-10 directional signs.

Except in an emergency, prior to the closing of an MTO roadway and the opening of a route detour, a roadway closing information sign must be erected at strategically selected locations of the road at least one week in advance of the actual closing. At the same time, information with regards to the closing may be posted on the road authorities website and/or given to local radio and T.V. stations and local newspapers, in accordance with road authority policy. Notices may also be distributed to affected households and businesses to advise them of the upcoming disruption in their area.

On some highways, and in particular, freeways, it may be preferable to close specific sections (such as longitudinal sections or one of the roadways in an express/collector configuration) without providing specific route detours. In this case, drivers, usually commuters who are familiar with the road network, can make their own decisions on alternate routes. Such advisory signage of road closures may be provided with either static signs or portable variable message signs (PVMS). Information is typically provided on the road section closed, hours closed, and period of closure (start and finish dates).

Such signage should be designed in accordance with the sign design principles provided in OTM Book 2. To avoid information overload for drivers, it may be necessary to provide the information on successive signs (or variable message signs (VMS) in phases) rather than on a single sign or sign display.

A pre-construction planning meeting should be held with the representatives of the road authority, police, and fire and EMS departments as well as any affected transit authority to advise them of the situation and allow them to assess how this will affect their functions and responsibilities. It may be necessary to involve a neighbouring municipality or different level of government when their roadway(s) intersects or is significantly affected.

Before a route or a temporary detour is opened to the public, all signs pertinent to the condition must be installed in their proper positions. Construction ahead signs must be installed when work first commences and the detour signs must not be exposed to view until the detour is required.

The following are typical layouts for reference purposes: [TL-40 - TL-42\(ii\)](#), [TL-47](#), [TL-49](#), [TL-59](#), [TL-60A](#), and [TL-60B](#).

2.3.7 Rolling Closures

A rolling closure is the use of police car(s), crash truck(s), and/or sign truck(s) to control the speed and restrain vehicles upstream of a construction site, so as to create a time window (usually 5 to 15 mins) when the road downstream of the lead vehicles is effectively clear of vehicles, which creates an unhindered opportunity for workers to do work and/or make traffic control changes at the work site clear of live traffic.

Example situations of where rolling closures may be a good method of traffic control include:

- Changing a lane closure on a freeway from a right lane closure to a left lane closure, or vice versa.
- Installing or removing an overhead sign structure.

In such cases, these very short duration (VSD) operations can be safely and efficiently carried out if traffic is temporarily prevented from entering the work zone. It is the decision of the road authority to use rolling closures. Paid duty police officers are recommended for freeway rolling closures due to increased hazard levels.

NOTE

Where detours are to be used a pre-construction planning meeting should be held with representatives of the road authority, police, fire, EMS and transit authority.

Before a route or a temporary detour is opened, all pertinent signs must be installed in their proper positions.

Use of paid duty police officers is recommended for rolling closures on freeways.

NOTE

2.4 Component Areas for Temporary Conditions

A **construction zone** encompasses the full length of a project (see [Figure 1 Component Areas](#)). Within a construction zone, there may be one or multiple work zones. The road authority may also legally establish a designated construction zone which will result in doubled speed fines within the designated construction zone when workers are present. See [TL-1, TL-2 & Section 2.6](#) for designated construction zone signage.

Figure 1 Component Areas

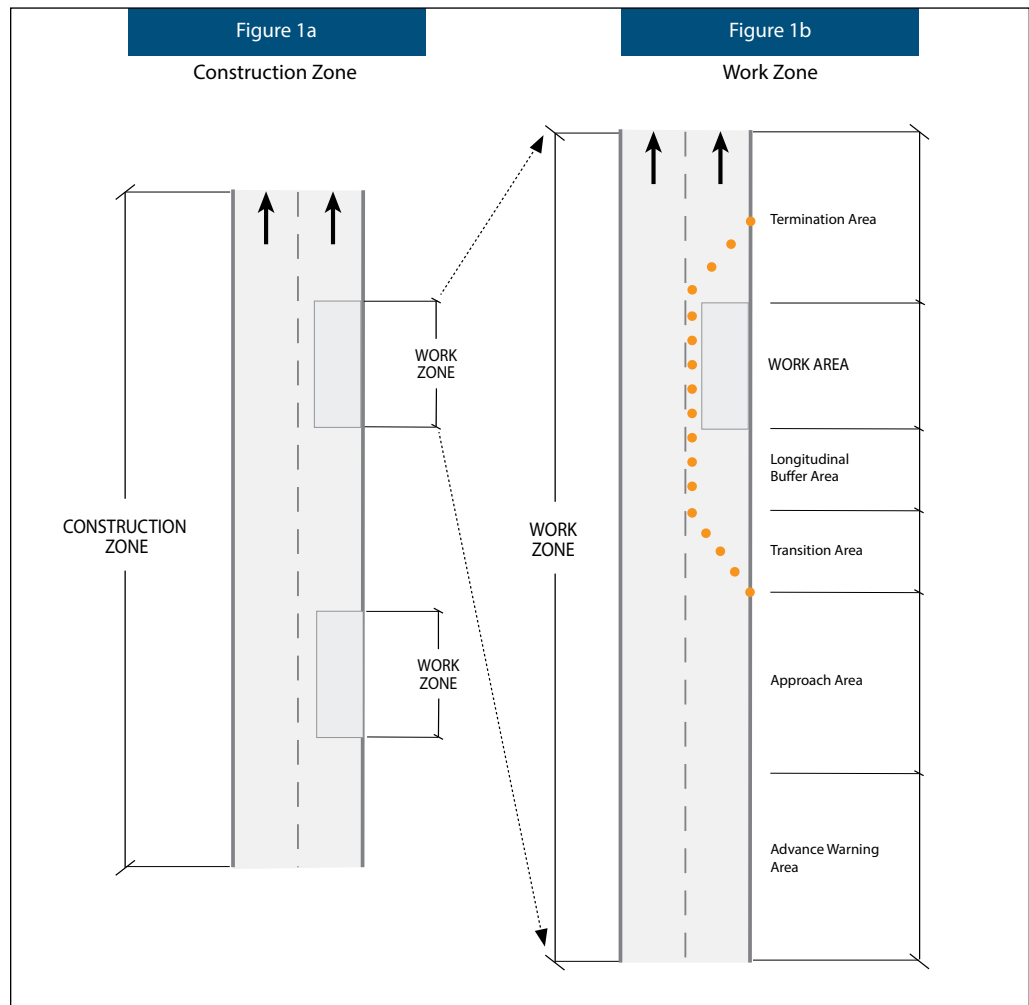

A **work zone** is an area where traffic control devices have been set up to provide positive guidance to road users through a temporary situation. It includes the entire section from the first advance warning sign through to the last traffic control device, where traffic returns to its normal path and conditions. A work

zone can be in any of the configurations described in [Section 2.3](#) and may be stationary or mobile. The amount of street space used by a work zone should be no more than is absolutely necessary.

A well-designed work zone normally contains six distinct component areas, in the following sequence:

- advance warning area;
- approach area;
- transition area;
- longitudinal buffer area;
- work area(s); and
- termination area.

These six component areas are described below in the order that drivers encounter them.

2.4.1 Advance Warning Area

The advance warning area lengths are used to alert road users of road work ahead. The required distances for the placement of advance signs, shown in [Section 8](#) (Typical Layouts), must be adhered to as closely as practicable.

The advance warning area may need to be increased to accommodate obstacles such as interchanges, bridges, and sightline restrictions. The advance warning area should be actively monitored. If queues are generated that extend beyond the advance warning signs then additional traffic control devices should be set up in advance of the observed end of a queue.

2.4.2 Approach Area

The approach area is used to inform road users of actions that are required or prohibited. The road users are informed of lane changes, speed reductions, passing restrictions, and the like. Road users will require the information at a sufficient distance in advance in order to be able to adjust to an altered situation before reaching it. The devices may vary from a single sign or flashing lights to a series of signs in advance of the transition area.

NOTE

A well-designed work zone normally contains six distinct component areas.

NOTE

The transition area must be obvious to road users.

The required distances for the placement of devices in the approach area, shown in [Section 8](#) (Typical Layouts), must be adhered to as closely as practicable.

2.4.3 Transition Area

In the transition area, traffic is channelled from the normal path to a new path required to move traffic past the work area. Work material, vehicles, and equipment must not be stored or parked in the transition area.

The transition area must be delineated by channelizing devices, unless otherwise indicated in the typical layouts. It contains the tapers and parallel sections (if more than one lane closed) that are used to effectively close the lanes. The length of the tapers and the parallel sections are extremely important. Guidelines for taper and parallel section lengths are outlined in Tables A, B, and C used in conjunction with typical layouts (see [Section 8](#)). If visibility is limited by a horizontal or vertical curve, a taper might need to be lengthened (beyond the length shown in typical layouts) so as to give drivers adequate warning and visibility of the start of the taper.

Note: The parallel sections referred to here are the lengths between successive tapers, and are not the same as the longitudinal buffer area (LBA) described below.

The transition area must be obvious to road users. The intended travel path must be clearly delineated so that road users will not mistakenly follow the wrong path. For long duration operations, there may be the requirement to remove or mask out existing pavement markings and possibly enhance the transition area with temporary pavement markings to identify a clear route where there could be confusion about the proper path.

2.4.4 Longitudinal Buffer Area (LBA)

In work zones, the LBA provides protection for traffic and workers, by providing an opportunity for road users to brake to a halt between the end of the transition area and the work area or Buffer Vehicle (BV) .

No traffic control devices, work material, vehicles, or equipment should be stored or parked in an LBA.

When a LBA with a BV is used, the appropriate distance to use in front (downstream) of the BV is called the Lateral Deterrence Intrusion Gap (LIDG). It is used in combination with the taper, LBA, and BV. (see [Section 5.5](#))

An LBA is recommended in all situations where practicable, and may even be used in circumstances which are not indicated in the typical layouts. As a guideline, an LBA is not required:

- for partial lane shifts, provided lane widths of at least 3.0 m are maintained;
- for non-freeway shoulder operations;
- where traffic is controlled by means of TCPs, automated flagger assistance devices (remote control devices), portable lane control signals (PLCS), or portable temporary traffic signals (PTTS); or
- in urban areas where normal posted speeds are 60 km/h or lower. In urban areas, drivers face more stimuli, including traffic signals, and drivers are less likely to be drowsy or inattentive. The other traffic control devices in the work zone should be sufficient to alert the drivers of the work area ahead, without requiring an LBA. The LBA lengths are included in Tables A, B, C and D and illustrated on the typical layouts, where applicable.

NOTE

No traffic control devices, work material, vehicles, or equipment should be stored or parked in an LBA.

2.4.5 Work Area

The work area is where the work takes place and/or equipment and material are stored. It is still considered a work area when work is temporarily stopped yet the road has not returned to its normal operation conditions. A work area may or may not contain a work vehicle.

The work area may be in a fixed location or move as work progresses. There may be more than one work area within a work zone. Every practical effort should be made to minimize hazards and distractions to drivers and workers. See the requirements of Regulation 213/91 under the OHSA.

2.4.6 Termination Area

The termination area is used for traffic to make the transition back to the normal path of a road. The termination area extends from the downstream end of the work area to the point where traffic is able to resume normal driving, typically at the end of the delineation of the termination taper on multi-lane divided roadways or at the TC-2 in the opposing direction of an undivided roadway.

NOTE

Ingress and Egress from the work zone should have minimal impact on traffic flow.

2.4.7 Additional Considerations in Component Area Design

2.4.7.1 Ingress and Egress

Ingress and egress from the work zone should be set up to ensure the safety of workers and road users and have minimal impact on traffic flow. The design should:

- ensure sufficient gaps are available in the traffic flow for ingress and egress of work vehicles;
- include delivery coordination (i.e., arrange for off peak hours if congestion is an issue);
- provide adequate acceleration/deceleration lanes for work vehicles that are entering/exiting the travelled lane. The slow down/speed up zones should be free of obstructions and/or workers; and
- not violate driver expectancy. Driver expectancy can be maintained by:
 - providing sufficient direction to the motorist;
 - allowing for adequate sight distances, accounting for curves and obstructions; and
 - including sufficient traffic control devices and lighting, so that drivers will not follow vehicles into the work area.

During construction:

- A TCP may be used to control work vehicles entering/exiting work area. The TCP may stop public traffic and/or work vehicles to protect work vehicles crossing or entering a roadway where the NPRS is less than or equal to 60 km/hr. Where the NPRS is greater than 60km/h, TCPs may control the work vehicles that are entering/crossing only, not public traffic.
- The spacing between markers may be widened in the termination area or extended across only one lane (in the termination of a multiple lane closure) so that the ingress/egress of work vehicles will not be hindered.
- All equipment, vehicles, and employee parking should remain clear of areas where trucks need to enter or exit the work zone.
- Openings that are not in use should be closed off.
- Channelizing devices should be regularly checked and traffic should be observed for indications of confusion.
- Dynamic signs approved by the road authority may be used.

2.4.7.2 Linear Space Restrictions

There may be situations where, due to linear space restrictions, the recommended lengths for the component areas cannot be achieved as shown in the typical layouts. However, this does not justify any failure to use sufficient warning and channelizing devices as may be required for public protection and guidance, or the protection of the worker. Every reasonable precaution under the circumstances should be taken for the protection of the workers and road users.

The following modifications may be considered:

In urban low speed areas characterized by closely-spaced intersections and/or many driveways and entrances within the available linear space:

- shorten or eliminate the termination area;
- reduce the advance warning area. All advance signs must be placed ahead of the approach area;
- relocate the taper and buffer areas upstream of the intervening obstruction;
- reduce or even eliminate the LBA. The LBA length is derived such that the taper plus the LBA length are greater than the stopping sight distance. In such cases, additional advance warning and delineation devices should be considered. The reducing or eliminating of an LBA should only be undertaken once alternatives, such as relocating the taper and buffer areas upstream of the intervening obstruction, have been considered and deemed impractical. [Section 2.4.4](#) describes the conditions under which an LBA is not required; and
- there may be situations where, even with the elimination of the LBA, it will be necessary to reduce taper lengths in the transition area. This may be offset by the use of additional traffic control devices, such as a TC-12 flashing arrow board or reduced barrel spacing.

On freeways, where a crash truck (CT) is required, linear space restrictions are less likely to arise. They may arise, for example, when working in the vicinity of interchange ramps. In this case, consideration should be given to lengthening the taper and/or LBA, bringing the start of the taper further upstream, and closing the interchange ramps. If this is not feasible, and some reduction in linear dimensions cannot be avoided, the LBA should be reduced, in conjunction with a reduction in the length of the taper. If such reductions are made, additional active advance warning devices must be used. The Lateral Intrusion

NOTE

Linear space restrictions do not justify failure to use sufficient warning and channelizing devices.

NOTE

Deterrence Gap (LIDG) between the crash truck and the work area should not be reduced, and the taper should not be reduced by more than 50% of its normal length (see Table C). Under such conditions, the use of a CT or other protection/attenuation device along with additional advance warning and guidance devices, must be in accordance with the guidelines outlined in [Section 5](#).

2.4.7.3 Horizontal and Vertical Clearance

Workers and/or equipment must not work or be positioned on the outboard side of cones or delineators. Sufficient horizontal clearance must be provided within the delineation of the work area to contain all work and/or equipment on or above ground, including elevated equipment such as bucket trucks used for work under bridge structures or overhead wires.

The travelled lane through the work zone must take into consideration height variance across the lane/shoulders and the effect of super elevation on tall vehicles (i.e. Tractor Trailers).

2.5 Duration of Work

Work duration is a major factor in determining the number and types of signs and devices to be used in temporary work zones and the manner in which they are used. The four categories of work duration used in OTM Book 7 are:

- Mobile Operations;
- Very Short Duration (VSD) work;
- Short Duration (SD) work; and
- Long Duration (LD) work.

The last three categories are all stationary operations.

Required component lengths and device spacing are treated differently for non-freeways and freeways because there is a greater expectation by drivers for smooth, uninterrupted traffic flow on freeways. Tables A, B, and C, and Section 8 provide the appropriate distances and are laid out as follows:

- Table A: Non-Freeways (Very Short Duration and Short Duration);
- Table B: Non-Freeways (Long Duration); and
- Table C: Freeways (Very Short Duration, Short Duration and Long Duration).

2.5.1 Mobile Operations

Mobile Operations involve work that is done while continuously moving, usually at low speeds (typically 5 to 30 km/h). Mobile Operations may have periodic brief stops related to the mobile activity which do not exceed a few minutes in duration. During a brief stop, no planned work takes place outside of the work vehicle. If a short stop is required at a predetermined specific location, it is VSD work rather than a Mobile Operation.

The advance warning area moves with the activity area. For some continuously moving operations where the volume is light and visibility is good, a well-marked and well-signed vehicle may be sufficient. If the volume and/or speed are higher, a BV equipped with a flashing arrow board should follow the work vehicle. Work vehicles must have, at a minimum, four way flashers and an amber 360 degree beacon (4WF/360°). A 360 degree beacon is a device with an intensely directed light source that continuously shows the light source thru all 360 degrees of the compass. This device must complete a full rotation every 1.5 seconds. The vehicle may also be equipped with, truck-mounted attenuators, and appropriate signs, as illustrated in the typical layouts. Where Mobile Operations are in effect in a travelled lane of a multi-lane divided high-speed highway (NPRS 70 km/h or greater), flashing arrow boards must be used.

Examples of Mobile Operations include longitudinal pavement marking, zone painting, and street sweeping.

Paving operations are a very low-speed type of Mobile Operation. However, their speed is so low that the typical layouts used for paving operations are those for stationary operations. Specific requirements for paving operations are described in [Section 5](#).

2.5.2 Very Short Duration Work (VSD)

Very Short Duration (VSD) work occupies a fixed location for 30 minutes or less, including the time that it takes to set up and remove traffic control devices. The work site may be moved along the road and make frequent and short stops where planned work takes place outside of the work vehicle. If a short stop is required at a specific location, it is VSD work rather than a Mobile Operation. If a worker is to be exposed to traffic for more than 30 minutes, including the time required to set up traffic control devices and work time, then greater protection is required and traffic control layouts for SD work should be used.

NOTE

Mobile Operations involve work that is done while continuously moving, usually at low speeds.

A 360 degree beacon is a device with an intensely directed light source that continuously shows the light source thru all 360 degrees of the compass. This device must complete a full rotation every 1.5 seconds.

Very short duration work occupies a fixed location for 30 minutes or less.

NOTE

Short duration work occupies a fixed location for more than 30 minutes but less than 24 hours.

Long duration work occupies a fixed location for more than 24 hours.

Examples of VSD work may include some utility work, minor road maintenance, pothole patching, surveying, and stormwater catch basin cleanout.

The use of active devices, such as flashing arrow boards, simplified set up and removal procedures, and rolling closures, is advocated for VSD work. The investment in these active devices helps to ensure adequate traffic control, reduces the time that the worker is exposed to traffic hazards, and yields more efficient and productive work operations.

2.5.3 Short Duration Work (SD)

Short Duration work refers to activities that require work areas that are continuously occupied by workers and/or equipment, for more than 30 minutes but less than one 24-hour period in duration. Short Duration work does not include work at a site that extends beyond 24 hours; such work is Long Duration.

Work at the same location may extend over more than one day, and still be considered Short Duration work for the purpose of traffic control device layout if all of the following conditions are met:

- The approval of the road authority is obtained.
- Any additional conditions stipulated by the road authority, including working hours, are complied with.
- Continuous work is less than 24 hours.
- The roadway (and sidewalk) are restored to the satisfaction of the road authority and returned to normal operation when the daily work shift (or authorized working period) is complete.

2.5.4 Long Duration Work (LD)

Long Duration work refers to activities which require a work area for longer than 24 hours. Longer exposure of workers and road users requires more positive guidance through a temporary condition. Temporary roadways and barriers may be provided, and inappropriate markings which cause driver confusion should be removed and replaced with temporary markings.

For stationary operations on freeways longer than five days in duration, TCBs are required, as required by Ontario Regulation 213/91, Section 67 under the OSHA.

2.6 Road User Considerations

NOTE

2.6.1 Speed Management in Temporary Work Zones

Managing compliance with NPRS or reduced speed limits within a work zone is necessary for both road user and worker safety. Where compliance is deemed to be an issue measures which have proven to be effective in helping to manage speeds and increase compliance with posted speeds in work zones include:

- **police presence** with enforcement in the work zone. This is the most effective measure for speed control. Provisions should be made to assist police to find a location to set up for enforcement in the constrained confines of a construction site;
- **establishment of a designated construction zone** to double the speed fines when workers are present. The effect of this measure is enhanced with the presence of police and enforcement;
- **use of active devices** to encourage compliance:
 - VMSs can be used to inform users of temporary conditions ahead that require them to slow down.
 - Speed display signs, where the speed of drivers is measured by radar and displayed to the driver on a VMS can be installed. The effect of a single VMS in a long duration work zone may be reduced with distance from the sign; therefore, multiple VMSs will be required to sustain a speed reduction. A VMS should not be used for one lane of a multi-lane highway as there is the potential for increased speed variance. This measure will have lasting effectiveness only if supported by periodic police enforcement;
- **use of pilot vehicles, pace vehicles or rolling closures** (see [Section 5](#)) for speed reductions for specific periods of time or specific work operations; and
- **posting of reduced speed limits** through either:
 - Installation of advisory speed limit signs (orange and black, non enforceable) together with narrower roadways or lanes through the work area; or
 - Installation of regulatory speed limit signs (black and white, requires establishing a designated construction zone).

NOTE

Guidelines for Posting of Reduced Speed Limits in Construction Zones

The travelled way through a work zone should be designed for a speed that is equal to or as close as possible to the design speed of the approaches to the work zone. If a speed limit reduction is deemed necessary, road authorities have the option of using advisory signs or reducing the regulatory speed limit, either temporarily or continuously through a construction zone. [Table 1 Posting of Reduced Speed Limits in Construction Zones: Appropriate Use of Advisory or Regulatory Speed Limit Signs](#) provides examples of the appropriate uses of each method. Both regulatory and advisory speed limit signs can be used on different portions of the same contract for severe work zone conditions. The road and police authorities should discuss logistics of enforcement and speed control.

Regulatory or advisory speed reductions should not be more than 20 km/h below the normal posted speed.

Regulatory and advisory speed reductions should not be more than 20 km/h below the normal posted speed. Speed limit reductions that are up to 20 km/h have been shown to be the most effective for keeping traffic in compliance, and increasing public and worker safety and mobility.

Both advisory and regulatory speed reductions must move with the active operation and there must be visible signs of work activity. When reduced speed limit signs are used for worker safety, the signs must be covered or removed when not required.

Speed reductions are more likely to be obeyed by motorists if they are perceived as necessary. If there is a good reason for reducing speed which may not be readily apparent to motorists, then the reason for the speed reduction should be provided through advance signage, repeated as necessary.

Regulatory speed limit signs shall only be installed when the appropriate police authority has been informed.

Regulatory speed limit signs shall only be installed when approved by the road authority. Once approved the appropriate police authority must be notified of the regulatory speed change prior to installation. Otherwise, only advisory signs should be used and all existing regulatory speed limit signs within the limits of the speed reduction must be covered or removed for the duration of the construction project.

A regulatory speed reduction should be implemented for a minimum road length of 300 m.

A regulatory speed reduction should be implemented for a minimum road length of 300 m or more, even if the work zone is less than 300m. Speed reductions can be implemented in stages. On a divided highway, the road authority may permit different speed limits for each direction of travel. In the case of an express/collector freeway, the speed limit may be lowered on one roadway, but not on another.

Table 1 Posting of Reduced Speed Limits in Construction Zones: Appropriate Use of Advisory or Regulatory Speed Limit Signs

| Method | Examples of where speed limit reduction's may be used. | Approval required |
|--|--|---|
| <p>Advisory speed limits</p> <p>Used whenever an unexpected change in geometrics is caused by the work activity.</p> | <ul style="list-style-type: none"> • bumps • low shoulders • drop-offs • limited but not substandard sight lines or stopping sight distance • limited but not substandard horizontal or vertical alignment • gravel surfaces (length less than 500m) • temporary lane closures • milled surfaces | <p>As required by the Road Authority</p> <p>For MTO highways, approved by contract administrator</p> |
| <p>Regulatory Speed Limits used for temporary, worker safety</p> <p>Only to be used when workers present.</p> | <ul style="list-style-type: none"> • Workers on a freeway within 3m of a travelled lane open to traffic where no barrier (see section 3.3.3) is used. | <p>Approval by the Road Authority required.</p> <p>For MTO highways, approved by the Traffic Section/Office by way of Designation of Construction Zone form and justification report that outlines the rationale for a speed reduction. or as per special provisions in the contract.</p> |
| <p>Regulatory speed limits used for continuous, public and worker safety on Long Duration construction with continuous hazards or where uninterrupted flow cannot be designed at or above the normal regulatory posted speed (substandard geometrics).</p> <p>Used 24 hours a day.</p> | <ul style="list-style-type: none"> • lane width less than 3.5 m on freeways or less than 3.0 m on non-freeways • shoulder width or offset to barriers less than 0.5 m, one or both sides • sudden lane narrowing • Substandard sight lines or stopping sight distance • multiple lane shifts, detours or transitions designed at less than the normal posted speed limit or those with no illumination • Substandard horizontal or vertical alignment • gravel surfaces (length greater than 500m) • multiple lane shifts with overlapping/ confusing pavement markings • Partial lane shifts onto a surface texture different from the main roadway. | <p>Approval by the Road Authority required.</p> <p>For MTO highways, approved by the MTO Traffic Section/ Office by way of Designation of Construction Zone form and justification report that outlines the rationale for a speed reduction.</p> |

NOTE

To reduce the regulatory speed limit or make enforceable the legislation on doubled speed fines, the road authority must establish a designated construction zone.

Only the MTO can establish a designated construction zone on provincial highways.

Designating the Construction Zone

To reduce the regulatory speed limit and/or make enforceable the legislation on doubled speed fines, the road authority must establish a designated construction zone. The contractor does not have the authority to establish such zones. The road authority may delegate the authority to a senior staff member who will designate the construction zone and set the speed limit, and ensure that records are kept, with details on when a speed limit is changed. Only the MTO can establish a designated construction zone on provincial highways.

The HTA requires that a designated construction zone must be clearly marked with standard “CONSTRUCTION ZONE BEGINS” and “CONSTRUCTION ZONE ENDS” signs found in Regulation 615 of the Act and [Section 6](#). The reduced speed limit becomes effective once the required signs are posted.

The limits of the designated construction zone should be selected such that there is sufficient room within the zone to accommodate all signs except for TC-1, TC-1A, TC-1B, TC-5, TC-5A, TC-5B and the information signs in advance of these. See [TL-1 - TL-4](#) for designated construction zones and reduced speed limit signage.

Rules that govern speed limits in designated construction zones and the doubling of speeding fines in a construction zone when there are workers present are detailed in Bill 169 of the Transportation Statute Law Amendment Act, 2005, which received Royal Assent on November 21, 2005.

Turn Prohibitions and Other Regulations in the Construction Zone

Under some circumstances, it may be necessary to prohibit turns, especially left turns, in a construction zone that passes through a major intersection in order to maintain adequate traffic flow. The regulations may be part-time or full-time, depending on the nature of the traffic volume. To be enforceable the regulations should be formal and enacted through the regulatory process. Transit or other exceptions may be required. Similarly, it may be necessary to ban parking that approaches a construction zone to ensure traffic control devices are visible and sufficient space is available for the transition area. Appropriate approvals must be obtained from the road authority. For MTO highways, Regional Traffic Office approval is required for all intersections and for any revision to the PHM-125 drawing for a signalized intersection.

2.6.2 Pedestrian Safety Considerations

The impact on pedestrians must be addressed in all temporary traffic control layouts where pedestrians are, or may be, present. To determine the extent of pedestrian accommodation required, observe existing pedestrian travel patterns and/or meet with the local community to assess the impact on:

- significant pedestrian generators;
- pedestrian origins and destinations;
- transit routes and stops; and
- intermodal transfer points.

Pedestrians should be provided with a safe, convenient, and clearly delineated travel path that ensures:

- Pedestrians are guided to, through, and from work sites in a clear and positive manner.
- The characteristics of the existing sidewalk(s) or footpath(s) are replicated as nearly as practicable.
- Pedestrian movements are inhibited as little as practical.
- Exposure to potential hazards is minimized.
- Pedestrians are not led into direct conflicts with work site vehicles, equipment, or operations.
- Pedestrians are not led into direct conflicts with mainline traffic that is moving through or around the work site.

Traffic control devices for pedestrians may include pedestrian directional and information signs, pedestrian barricades and fencing, and other delineation devices as described in [Section 3](#). The design of traffic control devices for pedestrian safety in a work zone should consider the following:

- It may be necessary to separate pedestrians from moving traffic, a work area (including work vehicles), or both with pedestrian barricades which provide a clear indication of a safe path through the work site. The top of a pedestrian barricade should be located at a minimum of 1.0 m above the surface on which it is installed.

NOTE

Pedestrians should be provided with a safe, convenient, and clearly delineated travel path.

NOTE

Pedestrians detour routes should be clearly defined with channelizing devices.

- Where activities at a work area could endanger the public (e.g., trenches, excavations), pedestrian barricades must be used.
- Detoured routes should be clearly defined by using channelizing devices. When delineating, provide continuous, detectable edging throughout the length. Mark temporary crosswalks.
- Minimum sidewalk or path width for pedestrians should be 1.2 m, and wider if necessary, for example, in commercial or school areas.
- Accessibility should be accommodated as per the Accessibility for Ontarians with Disabilities Act. For example, a minimum sidewalk or path width of 1.8 m is preferred in areas where accessibility may become an issue for two wheelchairs that are passing one another. The needs of visually impaired pedestrians should also be considered, as a construction site often provides a particularly challenging environment for individuals with this disability to safely and comfortably traverse.
- Pedestrian traffic control devices are not to be used for the control or channelization of moving vehicular traffic.
- Minimize any additional time and distance that pedestrians must travel. Place TC-40s and pedestrians use other sidewalk signs at intersections where an alternate route is available to the pedestrian, rather than mid-block.
- Where physical characteristics of an existing sidewalk have been modified, potential hazards may arise and the pedestrian should be alerted. To minimize potential risks:
 - Provide curb ramps.
 - Clearly mark any obstructions, especially at night.
 - Provide night-time illumination where existing is not sufficient.
 - Protect pedestrians from overhead hazards.
 - Avoid the use of material that may result in slippery walkway surfaces.
 - Regularly inspect path for debris and potential for tripping.
 - Where provided, railing should be sturdy, firm to grip, and smooth.
- Other temporary conditions or situations, such as modified rail grade crossings, should be appropriately demarcated.
- Perform routine inspection of pedestrian traffic control devices.

2.6.3 Cyclist Safety Considerations

Specific traffic control and/or accommodation for cyclists may be necessary through a temporary work zone. Under the HTA, cyclists have the same right to safe passage as motor vehicles (except where bicycles are legally prohibited), and should only be required to dismount and travel as pedestrians where absolutely necessary. Cyclists are also obliged to operate as vehicles, and generally do not require special signage unless [a] dedicated cycling facilities are affected or [b] specific actions are prescribed (e.g., follow bicycle detour, dismount and walk, caution due to rough surfaces).

However, the potential for cyclists to respond differently than motor vehicle operators to certain conditions should be anticipated and considered. For example, cyclists may not readily tolerate delays or restrictions that drivers accept. Unexpected conditions may be more problematic for cyclists than motor vehicle users. As a best practice:

- Provide early notice of projects that could cause significant inconvenience to cyclists (e.g., long detours), making use of cyclist organizations or user groups where available.
- Provide notification signs for all road users in advance of temporary conditions, consistent with general practice. Include distance tabs as appropriate.
- Ensure that signs do not intrude into the travel path of cyclists or pedestrians; if intrusion is unavoidable, maximize sign visibility.

Cyclists should be directed through the work zone where practicable. However, if an acceptable width of a shared lane, bike lane, or paved shoulder cannot be provided, or acceptable surface conditions cannot be maintained, detour cyclists around the work zone or divert cyclists to a pathway or sidewalk.

2.6.3.1 Directing Cyclists through the Work Zone

When a cyclist is directed through the work zone, consideration must be given to the surface conditions. Safe cycling requires a higher standard of travel surface than motor vehicle operation.

- Provide a smooth, hard travel surface at all times. Asphalt is ideal, but a compacted granular surface is acceptable for temporary use if well

NOTE

Cyclists should be directed through the work zone where practicable.

Safe cycling requires a higher standard of travel surface than for a motor vehicle.

NOTE

maintained. Avoid loose gravel, compacted aggregate, sand, mud, and standing water. Sweep surfaces regularly, especially the outer 2.0 m of the curb lane.

- Ensure that temporary surfaces (e.g., steel plates, timber decking) are skid-resistant with smooth joints at right angles to the travel path.
- Minimize vertical discontinuities. Where cycling volumes are high and discontinuities are unavoidable (e.g., at road cuts, raised ironworks, steel plates that are not recessed into the pavement), consider mitigating them with asphalt ramps. Use reflective paint and place devices (such as barriers, barrels or cones) to direct cyclists away from unramped grade changes.
- Where appropriate, use signs to notify cyclists of any variance from a smooth asphalt condition.

Roads with bike lanes or paved shoulders

Where cyclists approach a work zone in a bike lane or designated paved shoulder, it is preferable to maintain those facilities within the work zone, especially if cyclist volumes are high. If required, the alignment of bike lanes or paved shoulders may be diverted within the right of way.

- Provide a minimum bike lane width or paved shoulder of 1.2 m (1.5 m preferred).
- If motor vehicles are diverted into a bike lane or paved shoulder, notify cyclists that the bike lane or facility ends and shared lane operation begins with the appropriate orange and black signs. Apply with distance tabs in advance of lane closure, where appropriate.

Roads with shared lanes

Where cyclists approach the work zone in a shared curb lane, take care to preserve an acceptable shared lane width through the work zone.

- Notify cyclists of any reduction in shared lane width in the work zone and reaffirm the shared lane condition. No other treatment is generally needed if the shared lane width in a work zone is at least 3.5 m and operating speeds are 60 km/h or less.
- Consider shared lanes wider than 3.75 m where the concentration of heavy vehicles (trucks or buses) is significant or operating speeds exceed 60 km/h.
- Where the shared lane is the only travelled lane in that direction and its width is less than noted above, consider prohibiting motor vehicles from

passing cyclists and posting a reduced speed limit. Where the shared lane is one of two or more travelled lanes in that direction and its width is less than noted above, consider either posting a sign to instruct motorists to change lanes to pass cyclists, or providing a detour for cyclists.

- Cyclists may need additional lateral clearance when the cycling surface is rough. If so, consider providing a separate bike lane rather than a shared lane through the work zone.

Traffic control by using traffic control persons (TCPs) or temporary signals

In work zones where an alternating one-way traffic flow is controlled by TCPs or temporary signals, lower speeds of cyclists should be considered to enable them to safely clear the work zone.

- TCPs should communicate to each other about the presence of cyclists in the work zone.
- The timing of temporary signals should take into account the time required for cyclists to travel through the work zone. Cyclists operating speed, used to calculate clearance time, should consider the surface treatment, the available lines of sight, and the existence of potential refuge areas for cyclists in the work zone.

NOTE

Where alternating one-way traffic flow is controlled by TCPs or temporary signals, lower speeds of cyclists should be considered.

2.6.3.2 Cyclist Detours around the Work Zone

Detours do not require special signage for cyclists unless it is a bicycle specific detour. Bicycle specific detours should be considered if work zone or motor vehicle detour conditions cannot be made acceptable for cycling, or if a potential detour route for cyclists exists that is safer or more convenient than the detour route for motor vehicles.

- Provide advance notice of the detour.
- Provide guidance along the detour route.

2.6.3.3 Diversion of Cyclists onto Sidewalks

In situations where it is appropriate to divert cyclists onto sidewalks:

- In most circumstances, require cyclists who are diverted onto a sidewalk to dismount and travel through the work zone as pedestrians, walking beside their bicycles.

NOTE

Care must be taken to ensure that lighting used to illuminate the work site is not aimed at drivers.

- In some circumstances, consider allowing cyclists to ride on the sidewalk. Contributing factors may include the reduction in cyclist delay compared to dismounting and walking, and the ability to preserve sidewalk safety in view of the sidewalk width and volume of pedestrians and cyclists. Note that sidewalk railings adjacent to hazards (e.g., on bridges) may require modification to achieve a minimum height of 1.5 m.

2.6.4 Night-time Provisions

The provisions outlined below are required for planned night-time work operations, even though one or more provisions may be shown as optional for the daytime operations illustrated in the typical layouts:

- For night-time work of any duration, traffic garments that meet the OHSA requirements for night-time work must be used.
- All work vehicles present, must have four way flashers and an amber 360 degree beacon (4WF/360°).
- Where cones are used, they must be 700 mm with one standard white retro-reflective (minimum Type III, high intensity) 100 to 150 mm wide cone collar mounted onto the upper one-third of the cone taper, 100 mm below the top of the cone (reflectorized barrels, TC-54s, should be considered as an alternative to cones on multi-lane non-freeways where conditions permit, and must be used on freeways).
- Where a lane is closed or occupied, or shoulder work where no work vehicle is in place, a trailer mounted TC-12 flashing arrow board(s) or TC-7 and flashing amber light must be placed at the end of the taper.
- For intersection zone painting: 450 mm cones with a white retroreflective (minimum Type III, high intensity) cone collar may be used instead of 700 mm cones during the painting operation; after painting is completed, while the paint is drying, a TC-4 may be used as a replacement for the TC-12.
- Planned SD night-time work should not be conducted in fog or when roads are slippery. If wet or slippery roads or poor visibility are present when emergency work must be performed, an advance trailer-mounted TC-12 must be used and positioned as soon as practicable. Long duration taper lengths (Table B) (rather than SD taper lengths (Table A)) should be considered.
- Pedestrian barricades should be used where necessary to provide adequate protection and guidance to pedestrians in work zones.

2.6.5 Work Zone Lighting

2.6.5.1 Lighting of Work Area

The OHSA requires adequate lighting for its intended use.

Construction and maintenance and other activities often create conditions that are particularly hazardous at night when the ability of drivers to see clearly is reduced. The need for illumination by floodlight or steady burning lamps must be thoroughly investigated. Care must be taken to ensure that lighting used to illuminate the work site is not aimed at drivers, making it more difficult for them to see their intended path.

Lighting systems used for night-time work in work zones must be mounted at least 5.0 m above the roadway, except for dome or balloon style lights with soft wide light that does not produce glare. Lighting should be set up so that it is aimed in an arc from 90 degrees to the traffic flow, up to 45 degrees away from the traffic, but under no circumstances should lights be aimed at, or spill over onto, oncoming traffic. Any additional lighting mounted on construction or maintenance equipment should be directed and focused on the immediate work area, and should not be used as general floodlights to illuminate a construction site. This lighting should not interfere with the ability of motorists to navigate their way through the work zone.

2.6.5.2 Roadway Lighting through a Work Zone

Illumination of the driver's path through a construction work zone may assist the driver in making timely decisions, partially compensate for an undesirable alignment, or lessen the visual impact of an illuminated work area on the driver. Night-time construction often requires that lighting of working areas be brighter than the adjacent roadway. Construction illumination is directed away from the driver's path; however, some illumination typically spills onto the pavement surface and is reflected into the driver's field of vision. Illumination of the roadway through a work zone can reduce the impact of construction lighting on the driver.

NOTE

Lighting should not interfere with the ability of motorists to navigate through the work zone.

NOTE

2.6.5.3 Anti-glare Screening

Anti-glare screening on freeway construction work zones should be considered, to reduce the impact of headlights on the driver, where:

- a crossover is built on a freeway;
- the median width is reduced to 4.0 m or less;
- a curved highway alignment directs headlights into the path of opposing drivers;
- night-time truck volume is greater than 10%; or
- night-time traffic volume is level of service (LOS) D or greater.

Anti-glare screening should not be used in winter because of the impact on snow drifting.

3

Description of Typical Traffic Control Devices

Section 3 provides a description of traffic control devices and their general application in temporary work zones. Traffic control devices that are used for guidance and information, flow control, and positive protection are described. This section will assist all users in understanding available and appropriate devices. The information will be of interest to users who are required to either modify a typical layout or develop a new typical layout for a unique situation, which may require additional or alternate devices. General guidance is also provided for the application of new technologies. MTO specifications for channelizing, guidance and information devices can be found in [Section 6](#). Best practice procedures and MTO specifications for devices to control the flow of traffic and positive protection devices are provided in [Section 5](#).

NOTE

Section 3 provides a description of traffic control devices and their general application in temporary work zones.

3.1

Devices for Channelization, Guidance and Information

The functions of devices for channelization, guidance and information devices are:

- to alert road users to hazards created by construction, maintenance or other activities in or near the travelled way;
- to separate traffic from the work area, pavement drop-offs, or storage areas and direct road users safely past the hazards;
- to channelize road users from one lane to another, into a detour, or to a reduced width of the travelled way;
- to delineate the roadway alignment; and
- to produce the desired behaviour in roadway users.

Note: Delineating the transition taper

One of the most important elements in the layout of traffic control devices is the transition taper for full lane closure or other reductions in pavement width. When used for channelizing in a transition taper, devices should provide a smooth and gradual transition that is constant and easily interpreted. An inadequate taper is likely to produce undesirable traffic operations with resulting congestion and the possibility of collisions through the work zone or encroachment into the

When used for channelizing in a transition taper, devices should provide a smooth and gradual transition.

NOTE

Depending on the road environment either cones, construction markers or flexible drums are used to channelize road users and delineate the roadway alignment.

work area. Vehicles and equipment must not be kept in the taper area, except for TC-12 flashing arrow boards.

The minimum desirable taper length for various approach speeds and device spacing is provided in Tables A, B, and C in [Section 8](#). These tables also provide guidance as to speed-related distances and spacing relationships for the placement of general warning signs, and other guidance and information devices.

Devices typically used for channelization, guidance and information are described below.

3.1.1 Cones

Cones are used to delineate diversions and closed lanes, mark channelizing tapers in advance of closed/narrowed lanes, delineate roadside alignment, and guide traffic through the work area. They are also used to alert road users to hazards or separate traffic from the work area. They are primarily used on non-freeways or for very short or short duration operations on freeways. Cones affected by high winds should be used with ballast, stacked for ballast, or arranged in a configuration using a barricade/cone system.

3.1.2 Construction Markers

Construction markers are used to delineate diversions and closed lanes, mark channelizing tapers in advance of closed lanes, delineate roadside alignment, and guide traffic through the work area. They are also used to alert road users to hazards or separate traffic from the work area. For high-speed, high-volume work zones, consideration should be given to the use of other channelizing devices, such as flexible drums.

3.1.3 Flexible Drums

Flexible drums (barrels) are used to delineate diversions and closed lanes, mark channelizing tapers in advance of closed lanes, delineate roadside alignment, and guide traffic through the work area. They are also used to alert road users to hazards or separate live traffic lanes from work areas.

When used near traffic lanes, drums may reduce capacity. Where space permits, Drums are preferred on freeways and other high speed, high volume roads, and are required for night-time operations on freeways.

3.1.4 Barricades

A traffic barricade is a device, typically with one or two rails, which provides a visual indicator of a hazardous location or the desired path that a road user should take, but is not intended to contain or redirect a vehicle. The primary function of traffic barricades is to block off a portion or all of a roadway. Barricades can also be used to delineate excavations or work areas. Barricades are only supplemental to other delineation devices, and are not to be used as the primary delineation around an excavation or obstacle. Approaches to barricades should be adequately marked.

A general description of barricades for pedestrian safety is provided in [Section 2](#).

Barricades for worker safety, in and around the work site, including excavations, are covered by Ontario Regulation 213/91, Sections 26.3 and 235(4) under the OSHA.

3.1.5 Barriers

A barrier is a device, such as a TCB, which provides a physical limitation, through which a vehicle would not normally pass, and is intended to contain or redirect an errant vehicle of a particular size range at a given speed and angle of impact.

Barriers are primarily used as positive protection devices. Their use should be determined by the protective requirements of the location, and they should not be considered to be channelizing devices. For general guidelines on the application of barriers as positive protection devices and when they are required, see [Section 3.3.3](#)

3.1.6 Temporary Pavement Markings and Roadside Delineation

Temporary pavement markings are normally used in combination with appropriate warning signs, channelizing devices, and delineation to mark the intended vehicle path that traffic is to follow. To the extent practicable, road users should be provided with pavement markings within a work zone comparable to the markings normally maintained along adjacent roads.

On paved roads in temporary work zones, markings must be maintained:

- in long duration stationary work zones on non-freeways.
- in both long duration and short duration work zones on freeways where traffic is diverted from normal paths.

NOTE

The use of barriers should be determined by the protective requirements of the locations, and should not be considered to be channelizing devices.

NOTE

On MTO highways, orange pavement markings are only to be used when recommended by the Regional Traffic Sections.

Only one type of device should be used to provide roadside delineation through a work zone.

- where guidance by channelizing devices, delineation, or warning signs, does not clearly and adequately indicate the required vehicle path.

Temporary pavement markings should also be considered on projects with partial pavement removal (milling). These markings should as closely as possible reflect the pavement markings which have been removed. Temporary no passing zones should be marked within a construction zone where lane changing should be discouraged.

3.1.6.1 Orange Temporary Pavement Markings

Orange temporary pavement markings should primarily be used on highways with a normal posted speed of 90 km/h or higher where there are changes in alignment to accommodate construction and there is the need to:

- reduce driver confusion that results from removal of existing markings on asphalt, which can cause scarring and/or phantom marks under certain lighting conditions (e.g., low sun angle from sunrise or sunset);
- improve the contrast on concrete (the contrast between the orange markings and light coloured concrete is much better than that between white markings and concrete);
- enhance daytime and night-time visibility;
- provide an additional visual cue to indicate that the road user is within a construction zone;
- mitigate operational concerns as a result of multiple sets of pavement markings; or
- mitigate observed or expected driver confusion.

On MTO highways, orange pavement markings are only to be used when recommended by the Regional Traffic Sections.

3.1.6.2 Delineators

Delineation of the roadside during daytime can be effectively accomplished with pavement markings. However, night-time visibility often requires the use of delineators to provide long-range delineation of the roadway alignment. Furthermore, delineators remain visible under adverse weather conditions. Delineation is more fully addressed in OTM Book 11 (Markings and Delineation).

Delineators are small retroreflective devices that are erected in series to guide drivers, and are typically mounted on posts or barriers or in the roadway (e.g., temporary roadway pavement markers). They are placed in or on the roadway, adjacent to the shoulder (in rural areas) or on the edge of the travelled portion of the roadway (in urban areas), or on the top or side of the median or temporary barriers. Delineators describe the horizontal alignment of the roadway and help the driver to identify its limits. Delineators are guidance devices and are generally not intended as warning devices.

More than one type of device can be used to delineate the roadside but the application should be consistent throughout the work zone. Delineators include:

- temporary roadway pavement markers;
- painted curb markings for delineation (islands);
- small reflective post-mounted delineators (various designs and manufacturers);
- saddle-mounted delineators (and other barrier-mounted delineators) (various designs and manufacturers); and
- TC-18 CHEVRON ALIGNMENT sign.

Delineation of the roadside can also be provided with cones, construction markers, or flexible drums.

3.1.7 Signs

There are three classifications of signs that are used in temporary conditions: regulatory, warning, and guide. Warning and guide signs include both passive as well as dynamic signs that allow for illuminated and/or changeable messaging. Signs are placed in positions where they will most effectively convey the message without restricting lateral clearance or sight distance, and at advance distances that will allow a sufficient response time.

Classification of Signs

Regulatory Signs

Regulatory signs impose legal obligations and/or restrictions on all traffic. While temporary traffic control will generally be accomplished through warning signs, there are situations where the use of regulatory signs becomes necessary.

There are three classifications of signs that are used in temporary conditions: regulatory, warning, and guide.

NOTE

Regulatory signs, with few exceptions, must be rectangular in shape with a white reflectorized background and a black painted symbol or legend message and a black sign border, and must conform to OTM Book 5 (Regulatory Signs).

Warning Signs

Warning signs for temporary conditions are the most important signs used to advise road users of specific hazards that may be encountered. Warning signs for construction and maintenance or other work within a roadway must in general be diamond shaped with an orange reflectorized background and a black symbol and/or legend message and a black sign border. Where warning signs refer to permanent conditions that exist before, during, and after construction (e.g., steep hill, merge), standard black on yellow warning signs should be used.

Guide Signs

Guide signs are required to guide traffic around or through work areas or provide information to road users relative to detours, directions, types of construction, and other information considered beneficial or essential to the motorist.

Guide signs, with few exceptions, have a rectangular shape with the longer dimension being horizontal. In some locations, because of lateral space limitations, the longer dimension may be vertical. Temporary conditions guide signs typically have either:

- a white reflectorized background with a black legend and a sign border. Part of the sign legend may be black on orange to tell the driver about the changes that have occurred due to the work zone; or
- an orange reflectorized background with a black legend and sign border.

Guide signs that indicate road names and directions generally have a reflectorized green or blue background with a white legend and border, or a white background with a black legend. To show the changes due to construction, black legends or symbols on an orange reflectorized background may be used as an overlay on existing directional guide signs. Where conspicuity of the ground mounted guide signs compared to other Temporary Conditions orange/black signs is an issue, the road authority may require standard guide signs to be used.

Most of the signs in OTM Book 7 are designated by the letters "TC" followed by a number. The letters "TC" indicate the "temporary conditions" series of signs.

Regulatory signs used in temporary conditions have been given “Rb” numbers. Sign specifications for TC and relevant Rb signs are provided in [Section 6](#).

Sign patterns files are provided on the CD contained in OTM Book 2 (Sign Design, Fabrication and Patterns).

Roll-up signs may be used; however, the specifications must conform to the sign specifications outlined in the OTM book series (i.e., OTM Book 2 (Sign Design, Fabrication and Patterns) and [Section 6](#) in OTM Book 7).

3.1.8 Dynamic Messaging Signs and Devices

Advances in technology have and will continue to increase the use of dynamic signs and devices to provide guidance and information to road users or enhance passive signs in temporary conditions.

3.1.8.1 Portable Variable Message Signs (PVMSs)

A PVMS is a traffic control device that is capable of digitally displaying a variety of messages. A PVMS has elements on the face of the sign that can be activated to form letters or symbols. The message is limited by the size of the sign (*usually three lines with eight characters per line*). Multifunctional PVMSs have been developed in recent years which can fulfill a variety of functions, such as flashing arrow board, pre-programmed messages, and radar speed measurement and display, but may not meet all specified requirements for existing approved traffic control devices. These should only be used for those applications where they fully meet the requirements provided in OTM Book 7.

A PVMS is housed on a trailer or truck bed and can be quickly deployed to meet the temporary requirements frequently found in work zones or incident areas. The most common use of PVMSs in work zones is for long duration construction work. They are typically used to provide road users with advance information of work operations which are outside their expectations, such as closures or speed reductions.

In order to achieve a high level of respect for PVMSs, the message displays must provide road users with a concise message relevant to the situation that they will be encountering. Providing accurate information will enhance system credibility and therefore effectiveness. They should only be used for situations where the conditions are changing. PVMSs are always applied in addition to the re-

NOTE

PVMSs are applied in addition to the required signage as described in this book.

NOTE

The determination of whether and where PVMSs are to be used is at the discretion of the road authority.

quired signage as described in this book, and should never replace any of these required signs. PVMSs should not be used if standard traffic control devices adequately provide the information that a road user needs to travel safely.

In general, a PVMS could be used in the following conditions:

- Advance notification of closures due to construction.
- Advance notification of major special events impacting traffic.
- Notification of short-term lane closures and detours during construction, maintenance, and special events.
- Notification of long-term changes in road configuration.
- Temporary notification of long-term conditions until static signs can be manufactured.

The determination of whether and where PVMSs are to be used in a work zone is at the discretion of the road authority. The use of PVMSs in work zones is covered in [Section 6](#). Technical descriptions and specifications for PVMS signs are provided in OTM Book 10 (Dynamic Message Signs) and PVMS Best Practices Manual.

3.1.8.2 Flashing Arrow Board Signs (TC-12s)

Flashing arrow board signs are not only used to increase conspicuity, but also to guide traffic along the desired path. They are frequently used on urban and rural freeways or other multi-lane major roadways where day or night closures, slow-moving maintenance or construction activities, and high-risk operations require more elaborate means to warn and guide traffic through a work area, while also providing some physical protection to the work crew.

Flashing arrow board signs (TC-12s) are mounted on vehicles or trailers. The signs can be illuminated in single arrow mode (left or right), bar mode (straight line only), or both arrows mode. The arrow mode indicates that a lane shift is required by the road user. The bar mode indicates that a lane is closed and is used on the shoulder or by vehicles in a closed lane downstream of the initial arrow mode sign.

In mobile work operations, flashing arrow boards are used in the arrow mode on multi-lane roads (to reinforce the need to keep to the side of the vehicle, where no

cones can be used), and the bar mode is used on two-lane roads (where a flashing arrow could suggest to drivers that they can safely overtake the work vehicle/BV).

The TC-12 FLASHING ARROW BOARD sign must not be used in arrow mode with:

- a TCP (if the proximity of the TC-12 may reduce the visibility of the TCP, the TC-12 must not be used in bar or arrow mode);
- an automated flagger assistance device (remote control device);
- traffic control signal (portable or temporary); or
- the YIELD TO ONCOMING TRAFFIC sign.

Only TC-12s which conform to the requirements stated in OTM Book 7 [Section 6](#) may be used as a replacement for passive signs where shown on various typical layouts.

3.1.8.3 Speed Display

Speed display signs, where the vehicle speed is measured by radar and displayed to the driver on a VMS, have shown in some applications to reduce 85th percentile speeds by an additional 4 to 8 km/h over the reduction caused by static signs alone. When drivers see their speeds displayed, some may be genuinely surprised that they are travelling that fast, and may reduce their speeds. Other drivers may be uncertain as to whether a sign that shows their speed means that enforcement is nearby, and may reduce speed to avoid a potential fine. The sign may also display the legal posted speed at the time of measurement.

The effect of a single VMS in a long work zone may be reduced with distance from the sign; therefore, multiple VMSs may be required to sustain a speed reduction. VMSs should not be used for one lane of a multi-lane highway as there is the potential for increased speed variance. This measure will have lasting effectiveness only if supported by periodic police enforcement. Road authority approval and enforcement consultation should be obtained prior to the use of speed display signs. Refer to OTM Book 10, Dynamic Message Signs for guidelines on the safe placement of PVMS and manufacturer guidelines to ensure accurate readings.

3.1.8.4 Supplementary Flashing Lights

Construction, maintenance, and other activities within a roadway often create conditions that are particularly hazardous at night when the vision of road users

NOTE

Only TC-12s which conform to the requirements stated in OTM Book 7 Section 6 may be used as a replacement for passive signs where shown on various typical layouts.

Speed display VMSs should not be used for one lane of a multi-lane highway.

NOTE

Flashing lights must not be used in conjunction with PVMSs.

is reduced. There are both daytime and night-time situations where it is necessary to increase the target value and impact of warning signs by installing amber flashing devices over these signs to attract the attention of drivers to the sign message or identify a particular hazard or obstruction.

Flashing devices alone, with the exception of TC-12, must not be used for channelization purposes as they may obscure the intended vehicle path.

All flashing lights must operate on a lower setting of light intensity during hours of darkness.

Flashing lights must not be used in conjunction with PVMSs.

3.1.8.5 Highway Advisory Radio (HAR)

Highway advisory radio (HAR) may be used to provide travel advisory information to motorists as they are travelling in their vehicles. Information provided may relate to tourism and tourist attractions, major events, road construction or maintenance activities and road closures, road collisions, airline information, and border crossing information.

Where HAR is used to provide construction/maintenance related information, it is typically necessary to cover only a relatively limited geographical area.

HAR systems can use a licensed AM frequency (530 to 1700 kHz) or licensed FM frequency (88 to 108 MHz) for extended range broadcast. The higher bandwidth of FM frequencies offers an improved signal with a shorter range when compared to AM frequencies. Where competition for radio frequencies is intense, HAR frequencies tend to be allocated to the less-attractive extremes of the frequency bands.

HAR information can be provided by means of:

- a low power radio transmitter with a limited range (e.g., 10 to 20 km) which provides area coverage; or
- a very low power transmitter cable laid along the highway in question and along several approaching or intersecting roads. This often tends to be more expensive than the first option, depending on the length of the system, but is sometimes easier to license because of its limited range and hence unlikely to interfere with other radio stations.

As with any real-time travel advisory system, the information must be up-to-date and accurate, otherwise credibility will be lost.

NOTE

3.1.8.6 Road Information Telephone Lines

Some road authorities have found road information telephone lines to be an effective and useful means of communicating information to drivers on construction activities. The travelling public may be advised of this service in a variety of ways, including brochures, newspaper and radio advertisements, and highway signs, either static or VMS or both. Highway signs usually display a telephone number where the information can be accessed. Other media, especially brochures, can provide a menu of extension numbers to be dialled for information on specific projects, routes, or areas of the city. In Ontario, highway information can be accessed by calling 511. The posting of telephone numbers on road signs, encouraging drivers to call the number shown, is not good practice, because of the proven potential of distraction and increased hazard when using mobile communication devices while driving.

3.2 Devices to Regulate/Control the Flow of Traffic

In some situations, guidance and information devices alone may not be adequate to ensure the safe and efficient movement of traffic. Where one lane is available for traffic in both directions, or where guidance through a complicated work zone is necessary, devices to control the flow of traffic are required. The following sections provide a description of flow control devices, including their general application and limitation. For best practice procedures and specifications for flow control devices, refer to [Section 5](#).

3.2.1 Traffic Control Persons (TCPs)

TCPs are workers who manually regulate vehicle traffic using a TC-22 sign and often arm motion to prevent conflicts between workers, work zone activities, opposing road traffic, work vehicles, and pedestrians.

TCPs must not be used on freeways. TCPs may only be used on highways with a normal posted regulatory speed (NPRS) of 90 km/h or less and where only one lane is available for traffic.

NOTE

TCPs must not be used on freeways.

TCPs should not be positioned or operate within 30 m of an intersection with active traffic control signals.

TCPs may be used, where the NPRS is 90 km/h or less, to:

- stop traffic intermittently when required for work to be done within the travelled lane; or
- maintain a reduced speed of traffic travelling through/around a work area; or
- alternate one-way traffic movements where only one lane is available to accommodate two way traffic flow; or
- stop public traffic and/or work vehicles to protect work vehicles crossing or entering a roadway where the NPRS limit is less than or equal to 60 km/hr. (Where the normal regulatory posted speed limit is greater than 60km/h, TCPs may control the work vehicles that are entering/crossing only, not public traffic).

On sections where TCPs are not in sight of each other, an additional TCP or other means of communication is required to relay instructions to the TCPs at each end.

TCPs may be used for night-time operations, however this should be avoided if possible. On MTO projects approval from the Regional Traffic Section is required for traffic control plans using TCPs for night-time operations. Appropriate lighting must be provided so that the TCP is clearly visible to traffic in both directions.

TCPs must not be used on any roadway with a TC-12.

TCPs must not be used on a freeway or staged freeway.

TCPs should not interfere with the operation of active traffic control signals (temporary or permanent). TCPs should not be positioned or operate within 30 m of an intersection with active traffic control signals. Paid duty police officers must be used to control traffic in an intersection with active traffic control signals.

3.2.2 Temporary Traffic Control through the use of Signals

Signals may be used as an alternative to TCPs to control the flow of traffic through a work zone. There are currently four different electronic traffic control devices, which incorporate signal heads, that can be used to control traffic under temporary conditions. The devices and restrictions on their use are identified below. Specifications for use on MTO highways are provided in [Section 5](#).

3.2.2.1 Automated Flagger Assistance Devices (AFADs)

NOTE

Automated Flagger Assistance Devices (AFADs) are self contained, portable traffic control systems where the signal and/or control arm are operated remotely by a TCP. AFADs are only to be used as a supplement for TCPs to control two-way traffic on two-lane highways which have been reduced to one lane. One remotely controlled device is placed at each end of a lane closure that displays a red or amber lens, generally in conjunction with a control arm. At least one TCP must be dedicated to controlling the AFADs.

AFADs should be considered where the safety of TCPs within the roadway has been identified as a concern. The safety benefits include:

- Operation by radio remote control from a distance of up to 300m, which allows a TCP to stand off the roadway and out of danger from passing vehicles or construction vehicles that are backing up in the work zone.
- Where the work zone is short and visibility is good one operator can control multiple units at a distance by a remote control or can control traffic at one end of the work zone with a STOP/SLOW paddle and the unit at the opposite end with a remote control.
- Drivers may see remote controlled flagmen at a further distance than TCPs, which provides them with more time to slow down or stop , however compliance with an AFAD may not be as high as with a TCP.

An AFAD is not considered a traffic control signal according to the HTA. Road authorities may establish their own policies on AFAD use in work zones.

3.2.2.2 Portable Lane Control Signals (PLCS)

Portable Lane Control Signals (PLCS) consist of at least one vehicle traffic signal head, normally mounted onto a movable pole/trailer, with programmable signal timing. The use of PLCS is an alternative to continuous flagging by TCPs. PLCS may only be used to control one lane, two way traffic flow for VSD or SD work where the posted speed is 60 km/h or less. Other situations require the use of PTTs. Due to the temporary nature of these devices, legal drawings are not required by law; however, these devices can only be operated while the contractor is on site. PLCS must be installed in accordance with the requirements of Regulation 606 in the HTA, which covers the physical and signage requirements for these devices. This equipment must be removed and two way flow of traffic resumed whenever the contractor leaves the site.

PLCS may only be used to control one lane, two way traffic flow for very short duration or short duration work where the posted speed is 60 km/h or less.

NOTE

For MTO projects, the Ministry's Regional Traffic Office must approve the use of the PTTS system and all signal timing plans on a project-by-project basis.

Full illumination must exist if the closure continues at night. PLCS may not be used at an intersection or pedestrian crossover.

3.2.2.3 Portable Temporary Traffic Signals (PTTS)

PTTS consist of two standard traffic signal heads mounted onto movable trailers. On MTO contracts the trailers shall not be used at intersections to emulate traffic control signals. Where lane control is required for all long duration work or for VSD or SD work on roads with a NPRS of 70 km/h or higher PTTS must be used. The road authority must approve the use of this device so that road authority staff may monitor the operation of all PTTS and require the contractor to adjust the timing if traffic flow is adversely affected. For MTO projects, the Ministry's Regional Traffic Office must approve the use of the PTTS system and all signal timing plans on a project-by-project basis.

For the installation of PTTS, MTO requires an approved PHM-125 drawing to be completed for each stage of construction with unique locations for trailers, traffic signal heads, stop blocks, and placement of barrier or detection devices.

Full illumination must exist if the closure continues at night. PLCS may not be used at an intersection or pedestrian crossover.

For VSD and SD work, PTTS must be installed in accordance with the requirements of Regulation 606 in the HTA, which covers the physical and signage requirements. Driver action is prescribed by Section 146 in the HTA. For long duration work, PTTS must be installed to meet the requirements of Regulation 626 and Section 144 of the HTA.

PTTS must not be located in any place or manner so as to conflict with any existing signals or traffic control systems.

PTTS should only be used on Long Duration work for a maximum of 8 months (April – November), as maintenance and reliability concerns have been identified during the winter months. Outside this time period, the operation should return to normal two way traffic flow.

Conventional temporary traffic signals, such as span wire temporary traffic signals (SWTTS), must be used instead of PTTS at entrances, truck access routes, or pedestrian crossings.

If used for Long Duration work, a cost comparison is recommended to show that it is more cost effective to use solar powered PTTS as opposed to temporary traffic signals.

3.2.2.4 Temporary Traffic Signals (TTS)

Temporary traffic signals (TTS) normally comprise traffic signal heads on span wires and temporary wood poles. TTS are intended to be used as an alternative to permanent traffic signals for limited periods prior to or during the re-construction of roadways. TTS have a constant power supply and more closely resemble a normal signal installation.

TTS must be used instead of PTTS at entrances, truck access routes, pedestrian crossings, or other fixed locations where it is required to temporarily replace existing signals. If time of day functions are required due to known variances in traffic patterns (i.e., different maximum green due to long weekend traffic patterns), TTS are required.

These installations require MTO or the appropriate road authority approval of a schematic layout drawing (PHM125 for MTO applications) prepared as a standard signal base drawing or base plan, as identified in OTM Book 12 (Traffic Signals). The design standards/specifications for TTS are those that apply to permanent traffic signals as identified in OTM Book 12. Operational and timing requirements for TTS are the same as those for permanent signals.

3.2.3 Pilot Vehicles

A pilot vehicle is used on a two-lane road to guide, at an appropriate speed, a queue of vehicles through a one-lane section of a complex temporary traffic control zone or detour. The operation of pilot vehicles must include communication links with other traffic controls at each end of the one-lane section, such as TCPs.

Contractors may not control traffic with pilot vehicles without the road authority's approval. It is the road authority's decision whether to use the police, its own staff, and/or contractors to act as pilot vehicles. The decision to use pilot vehicles should be made prior to contract tendering.

NOTE

Temporary traffic signal installations require MTO or road authority approval of a schematic layout drawing.

NOTE

It is the road authority's decision whether to use the police, its own staff, and/or contractors to act as pilot or pace vehicles.

3.2.4 Pace Vehicles

Pace vehicles are used to control the speed of vehicles through a work zone where speed control is required but is difficult to achieve by other means.

Contractors may not control traffic with pace vehicles without the road authority's approval. The decision to use pace vehicles should be made prior to contract tendering. It is the road authority's decision whether to use the police, its own staff, and/or contractors to act as pace vehicles. Driver compliance is likely to be higher when paced by a police vehicle rather than a contractor vehicle.

The deployment of pace vehicles is not simple or straightforward. Extra care must be taken to ensure that it is safely done. Where significant queuing and congestion are expected, or pace vehicles must be deployed in low volume situations with vehicles approaching at high speed, advance signing should be provided to warn of possible stops or the use of pace vehicles. Caution and experience are necessary to effectively and safely apply pace vehicles in low volume, high speed traffic situations.

3.2.5 Paid Duty Police Officers

Driver compliance with traffic control devices is likely to be higher and observed speed lower when the police are present. The use of paid duty police officers may be specified in a traffic control plan to provide:

Enforcement – layout of a temporary configuration often presents challenges to effective enforcement. The road authority, contractor, and police should discuss expectations and procedures prior to beginning the work.

Authority – where enforcement is not practicable, the presence of paid duty officers alone and an enforcement vehicle in the work zone have proven to be effective measures to help manage speed and increase compliance with traffic control measures.

Traffic control with moving vehicles – the road authority may specify the use of paid duty officers and police vehicles to be used for pace or pilot vehicles, or conduct rolling closures.

Paid duty officers must be used to control traffic within 30 m of an intersection with active traffic control signals.

Traffic direction at intersections - TCPs must not generally be positioned or operate within 30 m of an intersection with active traffic control signals (temporary or permanent). Paid duty officers must be used to control traffic within 30 m of an intersection with active signals.

NOTE

3.3 Positive Protection Devices

Proper use of guidance/information devices and flow control devices should provide for the safe and efficient movement of traffic through a work zone. In addition, some temporary conditions may warrant the use of positive protection devices to prevent the intrusion of motorized vehicles into the work space and other hazardous areas of the work zone. The following sections provide a description of positive protection devices, including their general applications and limitations.

3.3.1 Buffer Vehicles and Longitudinal Buffer Areas

A Buffer Vehicle (BV) is a truck placed upstream of a work area to provide a protective shield for workers against an out of control vehicle approaching a work area. The BV should be unoccupied for stationary operations and may be equipped with a truck mounted attenuator or trailer mounted attenuator (TMA).

A BV without a TMA is defined as a blocker truck (BT). A BV with a TMA is defined as a Crash Truck (CT). A CT is preferred over a blocker truck as the TMA reduces the risk of injury to the occupants of the incoming vehicle and to the CT driver. A BV requires a mounted flashing arrow board (TC-12) and four-way flashers.

For stationary operations, BVs are typically used in combination with LBAs. An LBA is an empty space upstream of the BV that out of control vehicles can use to brake to a full stop.

Freeway applications

All BVs used on freeways must be CTs.

As per Regulation 213 Section 67(10), on freeway projects expected to require more than five days for completion, temporary barriers are required. For freeway projects that require five days or less to complete, or where the site geometrics cannot accommodate barriers, CTs and an LBA are required for stationary operations and one or more CTs are

A crash truck is preferred over a blocker truck as the truck mounted attenuator reduces the risk of injury.

NOTE

All buffer vehicles used on freeways must be crash trucks.

required for mobile operations. Where CT are used instead of barriers, the CTs must remain in place until the hazardous condition is no longer present (24hrs/day if necessary)

CTs are not required on freeways where a lateral offset of 3.0 m or more exists between the work area and traffic. For VSD work on freeway shoulders, CTs are not required but are recommended.

Non-freeway application

BVs are not specifically required on non-freeways under the regulations. However, an LBA is required for stationary operations on multi-lane roads for normal regulatory posted speeds of 70 km/h or higher.

For best practice procedures and MTO specifications for BVs, refer to [Section 5](#).

3.3.2 Glare Screens

Glare screens are mounted on the top of barriers to minimize distraction to road users. Their ability to discourage driver distraction and reduce headlight glare from opposing traffic may improve safety and traffic flow. Screens should not be placed where they may interfere with the safe operation of vehicles, in particular, where they may adversely affect road user visibility and sight distance.

3.3.3 Barriers

Barriers protect work zones and drivers by preventing or reducing penetration to the work zone and through a controlled redirection of an errant vehicle. The effectiveness of a barrier system depends on its correct placement, and size, speed, and angle of the approach of an errant vehicle. Most systems can absorb a hit from a passenger car up to an angle of 20 degrees without penetration.

Barriers are required to protect workers from traffic in an adjacent live lane under the following conditions (requirements of Regulation 213/91, Section 67, under the OHSA):

- construction projects on freeways;
- non-mobile operation; and
- the project requires more than five days to complete, although there may be circumstances that suggest the use of barriers for a period of less than five days to ensure the protection and safety of road users and workers.

In addition, barriers may be required for worker protection when completing maintenance work, refer to Regulation 851/90, Section 20, under the OSHA.

Where all of these conditions are present, but it is not practical to install the barriers as required, or where the project requires five days or less to complete, an LBA and a CT must be adequately positioned to protect the workers who are working on a Freeway.

Barriers may also be used to positively separate two-way, high-speed/high-volume traffic flows.

A description of some of the barrier systems used in Ontario work zones is provided below. Refer to [Section 5](#) for MTO requirements.

3.3.3.1 Temporary Concrete Barrier (TCB)

The most common barrier system is a TCB. TCBs used in Ontario must meet the requirements of the Ontario Provincial Standard Specifications (OPSS) and be placed in accordance with the Ontario Roadside Safety Manual. They are commonly used in section lengths of 2.5 to 4.0 m, connected together to form a continuous barrier.

Concrete barriers are not intended to be used across a road for a road closure. However, if the closure is treated as a dead end road, the majority of traffic is already rerouted, and the consequences of not closing the road with the use of a barrier are worse, then a TCB maybe used as a barrier for the road closure and the required advance signage and traffic control devices must also be installed. Concrete barriers must not be used alone and therefore do not have to be placed at an angle as for the purpose of a lane closure. However, TCB must not be placed perpendicular to the direction of travel. The maximum permitted deflection rate for TCB is specified in OPSS Standards.

3.3.3.2 Moveable Barrier

A moveable barrier consists of sections of linked barriers that can be mechanically shifted laterally, through the use of a special purpose vehicle. A moveable barrier is typically used:

- to provide a reversible lane; and

NOTE

TCB must meet the requirements of the Ontario Provincial Specification Standards (OPSS).

NOTE

Applications of moveable barriers must be approved by the road authority.

Ballast filled barriers must only be used in urban areas of low speed and for vehicles that weigh 1800 kg or less.

Environmental regulations and guidelines must be followed for the proper removal and drainage of ballast filled barriers.

- when the risk associated with frequent lane closures required to accommodate construction staging warrants the expense of a moveable barrier.

Applications of such barriers must be approved by the road authority.

3.3.3.3 Ballast Filled Barriers

Ballast filled barriers are longitudinal barriers of segmented polyethylene plastic shells with a steel framework, which are designed for use with ballast of water or sand.

Ballast filled barriers should only be used when approved by the road authority.

Ballast filled barriers are relatively easy to install, given their initial low weight in comparison to other longitudinal barriers. Empty sections of a barrier may be placed by hand in areas that may have otherwise become restrictive for the use of heavy lifting equipment. Steel rails are then placed on the barriers to redirect potentially impacted vehicles, and water or sand is used as the ballast to secure the barrier. Barriers must be filled in accordance to manufactures specifications in order to be effective. Steel rails must be installed to completely avoid vehicle penetration through ballast filled barriers.

When ballast filled barriers are impacted, the deflection may be as great as 2.0 m to 8.0 m. The deflection is greater for ballast filled than concrete barriers, mainly due to the lighter weight of ballast versus concrete. For this reason, ballast filled barriers should only be used in urban areas of low speed and for vehicles that weigh 1800 kilograms or less.

In cold weather, sodium chloride or an environmentally friendly antifreeze should be used to prevent freezing of the ballast water inside the barrier. Care must be taken upon impact, as the ballast water could pose a potential hazard if the water forms into ice on the surface.

Environmental regulations and guidelines must be followed for the proper removal and drainage of ballast filled barriers. The disposing of the ballast water when the barrier is removed may require the water to be pumped and transported offsite.

3.3.3.4 Barrier End Treatments

Adequate end treatments on barriers are needed to reduce the severity of impacts. End treatments must meet the requirements of OPSS and the Ontario Roadside Safety Manual and may include:

- connection to an existing barrier that avoids exposure to the barrier end;
- attachment to an end treatment (e.g., impact attenuator);
- flaring the barrier end beyond the edge of the clear zone; and
- burying the barrier end in the backslope.

NOTE

The determination of whether and where mobile barriers can be used is at the discretion of the road authority and all necessary permits must be obtained.

3.3.4 Mobile Barriers

Mobile Barrier systems consist of a modular unit on wheels pulled by a standard truck tractor with reversible axles which allow it to be reconfigured for either right or left applications. The mobile unit should be orange in colour to also alert drivers that road work is taking place. For use on freeways, the unit must also be equipped with an approved energy attenuator.

The mobile unit alleviates the need for road crews to use a TCB, which reduces the exposure of workers to traffic and the overall duration of work.

Typical mobile units can be expanded from 13 m to 31 m in length and can be customized by adding: PVMS, speed detection device, portable generator, lighting, and rear wheel steerable axle. The determination of whether and where mobile barriers can be used in work zones is at the discretion of the road authority. The use of mobile barriers must be approved by the road authority and all necessary permits must be obtained.

3.3.5 Vehicle Arresting Systems

Vehicle arresting systems are defined by the U.S. Federal Highway Administration as portable netting, cables, and energy-absorbing anchors designed to gradually slow down errant vehicles and prevent penetration into activity areas. Vehicle arresting systems are used to prevent errant vehicles from entering the work space when sections of a roadway are frequently opened and closed during extended work operations. The system is placed across the roadway at the closure point, downstream ramps, and other potential entrance points. Where provisions are necessary to allow construction traffic to bypass the system, the road authority may elect to have a paid duty officer stationed at the bypass to prevent unauthorized entry into the work space. Application and design of Vehicle Arresting Systems must be approved by the road authority.

NOTE

3.3.6 Truck or Trailer Mounted Attenuators (TMAs)

An attenuator is an energy-absorbing device mounted onto the rear of a truck or trailer, which will deform upon impact in a controlled manner, thereby reducing:

- the rate of deceleration (and associated injury) for the occupants of a vehicle which has struck the TMA from the rear; and
- the rate of acceleration (and associated injury) for the driver of the truck.

TMAs must satisfy the requirements of the National Cooperative Highway Research Program (NCHRP) 350 Level TL-2 (70 km/h) or TL-3 (100 km/h), and should be selected for the NPRS of the roadway for their intended use. All TMAs used on freeways must satisfy the level TL-3 requirement (100 km/h).

3.3.7 Temporary Transverse Rumble Strips

Temporary Transverse Rumble Strips (also called in-lane or travel-way rumble strips) are grooved or raised corrugations that are placed on the highway pavement surface perpendicular to the path of travel, such that motor vehicles passing over the corrugations simultaneously generate audible and vibratory stimuli. Strips can be glued, screwed onto the road surface or can remain in place by weight and friction. They are typically used in sets of three.

Temporary Transverse Rumble Strips are used to alert motorists that they are about to enter a work zone where unusual or unexpected road conditions exist, to bring driver's attention to other warning devices or a change in the roadway ahead that requires a speed reduction or stop.

Application and design of Temporary Transverse Rumble Strips must be approved by the road authority.

3.4 Application of New Technologies

Technology and best practice are not static. New technologies and techniques continue to be developed for application in work zones. Technology development is welcome, and it is important that new technologies and techniques are tested in real-life situations. It is also important, however, that new technologies and techniques be accepted into standard practice and guidelines through an orderly, controlled process.

Initially, new technologies may be accepted as supplements to existing prescribed traffic control devices.

For this purpose, MTO has established an arrangement with the Ontario Good Roads Association (OGRA) to support “The Road Authority” (TRA). The TRA is a web-based database application that provides an information resource on roadway products, services, and technologies used in the province. There are two types of evaluations that can be documented on the site, which include: 1) the pre-qualification of a product or vendor which is then listed on the Designated Source for Materials (DSM) list for the participating jurisdiction, and 2) product classification through The Ontario Provincial Standards (OPS) Products Management Committee (PMC), which is responsible for the evaluation of products and technologies against applicable standards and specifications. Further information on the processes for these two scenarios is available from the TRA website.

Designated Sources for Materials

The MTO DSM is the official list of pre-qualified products and vendors for use on MTO highway construction and maintenance contracts. The DSM acceptance criteria for the product listing may include but are not limited to testing in the laboratory, evaluation of a product under field conditions, and inspection of the manufacturer’s facilities.

The MTO does not warrant that the sources listed on their DSM will produce an acceptable or a sufficient product for any contract. The MTO DSM listing only indicates that the listed manufacturer/distributor is capable of producing a product that meets MTO requirements or that it has demonstrated the ability to meet them in the past.

Vendors are encouraged to register their product on the TRA for the benefit of all road authorities.

Product Classification

The OPS PMC is responsible for the evaluation of products and technologies against applicable standards and specifications. The TRA publishes the decisions made by the committee. Products that are designated as “Accepted for Use” have been reviewed by the committee, have met the established criteria, and have been recommended as acceptable products for use in Ontario. Large municipal governments may consider placing these products on their lists of ac-

NOTE

Vendors are encouraged to register their product on the TRA for the benefit of all road authorities.

For trials on MTO highways, approval is required from the Regional Traffic Office and the head office traffic section should be consulted.

NOTE

ceptable products, while smaller municipalities may solely rely on the lists published by the MTO, other municipalities, or the TRA (The Road Authority, 2011).

If a product is classified as “under evaluation,” lab testing and field trials are in progress and it has not been evaluated yet as an accepted product for use (The Road Authority, 2011).

In addition, the MTO or other road authorities may conduct field evaluations of new devices or layouts. Initially, new technologies may be accepted only as supplements to existing prescribed traffic control devices, not as replacements for them. As experience and satisfaction are gained with the new technologies, some of them may be accepted as part of the family of prescribed traffic control devices, while others may continue to be accepted, but only as supplemental devices. Their mandatory use will be at the discretion of the road authority.

Where a road authority is considering the trial of a new device, a change to an existing one, or the application of an existing device outside general policy or practice, an assessment of the need and evaluation of effectiveness should be conducted and documented. For trials on MTO highways, approval is required from the Regional Traffic Office, and the head office traffic section should be consulted on the proposed process and provided with the results of the assessment for potential policy development.

The following information should be documented in a proposal for a field evaluation of a new technology:

- detailed description and drawings of the traffic control device/application that is being proposed;
- description of the problem that the proposal seeks to overcome;
- the location of the proposed trial and why this site is suitable;
- involved time frames;
- how the problem can be addressed by non-standard treatment better than existing practices;
- outcomes of any previous trials or investigations;
- jurisdictional scan of relevant legislation, policies, or guidelines;
- assessment of any new safety or other problems that may result;

- rationale that the proposed trial will be easily understood by road users;
- list of all interested parties and the likely level of up-take;
- information on consultation undertaken and/or proposed; and
- a plan for close monitoring of any field trial, especially in the early stages of implementation.

Prior to field testing, detail how the performance of the device will be assessed including any computer or other technical analysis used.

The results of the assessment should show:

- how the proposal affects each class of road user with respect to the desired outcome;
- the level of understanding of the proposed device/application (obtained from road users through observation, interviews, or questionnaires);
- the reliability/performance of the device;
- that the information collected was well defined and appropriate;
- that a sound scientific design was used with appropriate controls so that any conclusions reached are supported by robust statistical analysis.

NOTE

NOTE

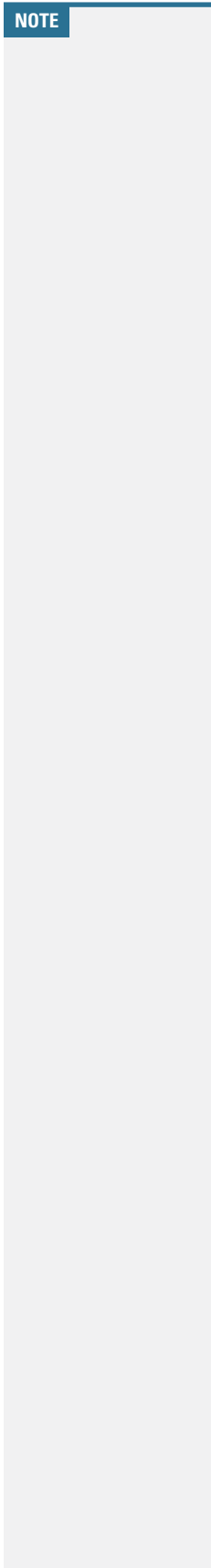

4

Implementation of Temporary Traffic Control

Section 4 describes best practice procedures for implementing temporary traffic control, from preparation before beginning work to the set up and removal of traffic control measures/devices. This section is to be used by any person designing, project managing, or physically providing or setting up traffic control. Guidelines for ongoing inspection of work zones are also provided in this section to assist road authorities and contractors in ensuring appropriate use of traffic control devices. Refer to [Section 3](#) for a general description of the devices and typical applications, or [Section 5](#) and [Section 6](#) for device specifications.

4.1 Preparation Before Beginning Work

Before work begins, all approvals must be obtained, a site visit shall be conducted to evaluate the conditions that affect traffic control requirements. A Traffic Protection Plan and a separate traffic control plan (if required) must be prepared and communicated.

A Traffic Protection Plan is a Ministry of Labour requirement for all projects. (Regulations 213/91 and 145/00 under the OHS Act). The OHS Act requires the employer to develop in writing and implement a Traffic Protection Plan for their workers if any of the workers may be exposed to a hazard from vehicular traffic. The Traffic Protection Plan must list the vehicular traffic hazards and the measures to be used to protect workers. The plan must also be kept at the project site and made available to an inspector upon request.

The “measures to be used to protect workers” identified in the Traffic Protection Plan are a main component of a traffic control plan for a temporary condition. The traffic control plan must also account for road user safety and road user mobility. For major projects this requires more design and documentation than the Traffic Protection Plan alone. (see [Section 2](#) (Temporary Work Zone Design)). For major projects, the development of a traffic control plan may be iterative and include multiple layouts, detours, staging sequences, construction vehicle ingress to and egress from work sites, temporary barriers, and removal of existing pavement markings. For minor projects, the process may be primarily the selection of appropriate typical layouts based on the site evaluation and documentation within the Traffic Protection Plan. For minor projects the Traffic

NOTE

Section 4 describes best practice procedures for implementing temporary traffic control.

Before work begins, all approvals must be obtained, a site visit should be conducted, and a traffic control plan must be prepared.

The OHS Act requires the employer to develop and implement a traffic protection plan if workers may be exposed to a hazard from vehicular traffic unrelated to the project.

NOTE

Protection Plan and the traffic control plan are essentially the same. The traffic control measures and guidelines included in OTM Book 7 have been developed to account for both worker and road user safety as well as road user mobility.

The following tasks should be completed before beginning work on the road. Not all tasks will be required depending on the complexity of the work being done and specific requirements of the governing road authority. All tasks should be designated to an individual(s) with the appropriate authority and skills necessary to complete the work.

Obtain Approvals and Provide Notification

- Ensure knowledge of all applicable regulations, permit requirements, and work restrictions.
- Obtain the necessary approvals from the road authority, for example, when:
 - establishing a designated construction zone;
 - posting reduced regulatory speed limits;
 - using partial lane shifts;
 - using portable or non-portable temporary traffic signals;
 - conducting traffic control with moving vehicles other than for setup or removal;
 - applying orange pavement markings;
 - deploying PVMS;
 - installing speed display signs;
 - using a mobile barrier vehicle; and
 - applying a new technology.
- Notify the police, fire department, Emergency Medical Services (EMS), transit authorities, road authority, and any other agencies which may be affected by the maintenance, construction, or other work activities.
- Provide notice to the public of the works planned or in progress, as appropriate, through local media and signage.
- Inform occupants of abutting properties, either orally or by written notice, of parking prohibitions or access limitations.
- Discuss speed control and enforcement with the road and police authorities.

Perform a Site Evaluation and Identify Conditions that Affect Traffic Control Requirements

- Review the cross section geometry of the road and the available platform.
- Assess the available sightlines, accounting for hills and curves, and the impact on required stopping sight distance.
- Observe operating and posted speeds.
- Calculate the volume* of traffic. Consider the time of day that the work is to be undertaken and any major trip generators that may impact traffic flow at specific times, such as a school, coffee shop, or factory.
- Note existing traffic control devices and proximity of signals.
- Assess need to accommodate vulnerable road users, including pedestrians/cyclists, children in school zones, the elderly, or persons with disabilities.
- Note non-traffic hazards that may affect traffic redirected from the normal path, such as overhead wiring, low bridges, islands, or medians that may obstruct the turning radii of trucks or buses.
- Note any visibility obstructions to road users and workers, such as signs, street furniture, and buildings or direction of sunlight.
- List other site conditions that may lead to challenges in the set up and operation of temporary traffic control devices.

[Figure 2 Conditions that Affect Traffic Control Requirements](#) shows a sample checklist of the conditions that affect traffic control requirements.

**Note: The best available traffic count data, or at least a three-minute count of traffic at the site multiplied by 300, will give a workable estimate of the daily traffic volume. Normally, road work is not done in peak traffic periods, and hence, it is appropriate to take the count in off-peak periods. If road work must be done in peak traffic periods, the traffic count should be made in the peak period.*

Develop a Traffic Control Plan

- Determine the location of the proposed work area and identify the required degree of encroachment into the roadway (e.g., off shoulder, shoulder, lane encroachment, partial lane shifts, lane closure, detour, and rolling closure (see [Section 2.3](#) (Configurations for Temporary Conditions))).

NOTE

Modifications to a typical layout should identify why the typical layout is not applicable and how the modifications are equivalent with respect to workers safety, road user safety, and mobility.

- Determine the duration of the work to be undertaken (see [Section 2.5](#) (Duration of Work)).
- Evaluate the need for traffic flow control (e.g., use of TCP(s), - paid duty police, or signals (see [Section 5](#) and [Section 3.2](#))).
- Select the most appropriate typical layout(s) for the work based on the site evaluation and work area requirements (see [Section 8](#)).
- Review the selected typical layout(s) to ensure that all site specific conditions are adequately accommodated. If the typical layout(s) are not appropriate, modify or design a new layout in accordance with sound traffic engineering principles and as outlined in [Section 2](#). Any modifications should identify why the typical layouts are not applicable and how the modifications are equivalent with respect to worker safety, road user safety, and mobility.
- Plan for the safe movement of pedestrians, cyclists, and other vulnerable road users, ensuring that vehicle and pedestrian movements are properly separated (see [Section 2.6](#) (Road User Considerations)).
- Determine schedule of traffic control devices, including sign sizes and quantities required (see [Section 5](#) and [Section 6](#)).
- For long duration work, determine whether existing pavement markings must be removed and replaced by temporary pavement markings.
- Select hours of work to avoid peak periods, if possible.
- Document a traffic protection plan for the protection of workers in the work zone, as required by Regulations 213/91 and 145/00 under the OHSA.
- Develop an emergency and incident management traffic control plan, which facilitates emergency vehicle access to work zone locations as necessary.
- Ensure that the traffic control plan is understood by all responsible parties before the site is occupied. Any changes in the traffic control plan should be approved by an authorized individual/position.

Figure 2 **Conditions that Affect Traffic Control Requirements**

Site Factors Assessment

Freeway yes no

#of lanes: in same direction _____ in opposing direction _____ divided _____ undivided _____

Shoulders: yes no paved unpaved

Sidewalks: yes no Bicycle Lane: yes no

Normal Posted Regulatory Speed Limit _____ Traffic Volume _____ % of heavy vehicles _____

Existing traffic control devices & proximity of signals

Observed operating speeds _____

Sightline limitations _____

Significant trip generators _____

Vulnerable road users _____

Weather conditions _____

Non traffic hazards _____

Other challenges _____

Vehicle Hazards to Workers

Moving Turning Other _____

Trucks Limited Visibility

Duration of Work

Mobile Very Short Short Long

Degree of Encroachment

Off shoulder Lane Encroachment Lane Closure(s)

Shoulder Partial Lane Shift(s) Detour

NOTE

Workers must not perform other functions while installing or removing traffic control devices.

On site duties

As required by Regulations 213/91 and 145/00 under the OHSA, ensure that all workers responsible for installing or removing traffic control devices or measures, and TCPs:

1. are competent workers;
 2. are aware of the requirements of the OHSA;
 3. have been trained in the application of OTM Book 7; and
 4. have been given written and oral instructions in a language that they can understand.
- Workers must not perform other functions while installing or removing traffic control devices (for TCPs, see also [Section 5.2](#)).
 - Ensure that enough vehicles (including CTs), signs, barriers, barricades, and markers are taken to the work site to provide appropriate protection, and that TCPs are available and on site when required. If night-time protection is required, ensure that the appropriate devices are available.
 - Ensure that the vehicles, signs, barricades, and markers are in good and clean conditions (see [Section 7](#) Quality Replacement Guidelines for Traffic Control Devices) and meet the applicable specifications, including minimum reflectivity levels (see [Section 6](#)).
 - Cover or remove any conflicting, existing traffic control devices.
 - Record that the traffic control devices were installed according to the plan (or typical layout), and any modifications to or deviations from the plan.

4.2 Principles for Set Up and Removal of Traffic Control

The set up or removal of traffic control (e.g., lane closures) on highways involves an additional element of risk for traffic control workers and road users until all devices are in place.

The principles and procedures set out below have been developed to minimize the risks for all concerned. Where competing risks need to be weighed, the safety of the workers who are handling traffic control devices on the highway is considered paramount since these workers are the most vulnerable.

Where competing risks need to be weighed, the safety of the workers who are handling traffic control devices on the highway is considered paramount

Workers who set up, use, or remove (take down) work zone traffic control should apply the following safety principles. These principles apply to both non-freeways and freeways.

General

- Plan set up and take-down in advance.
- Minimize worker exposure to traffic.
- Consider the use of rolling closures to control the speed of vehicles upstream of the set up area and create an unhindered opportunity for workers to do the work.
- Make sure workers are visible and conspicuous to oncoming traffic and construction vehicle operators.
- Ensure that any TCPs deployed are given written instructions and trained by a qualified person, and properly equipped/clothed as per the OHSA.
- Be aware of approaching traffic. Plan an escape route.

Set up

- Position work vehicles upstream of the work (between workers and approaching traffic) rather than downstream, so that their flashing lights and/or flashing arrows indicate a visual presence and obstacle to drivers.
- Assemble and disassemble traffic control devices away from the roadway. Where practicable, deposit traffic barrels in advance, along the shoulders adjacent to the lane closure.
- Set up work zone traffic control devices starting at the upstream end of the work zone and proceeding downstream.
- When installing a continuous line of channelizing devices, always place the channelizing devices in sequential order from the upstream end.
- Reduce barrel spacing on the inside of curves, on hills, in the immediate vicinity of ramps and the work area, and in the taper if considered needed to reinforce the closure.
- Use cones for SD daytime work only (barrels are preferred).

NOTE

Set up work zone traffic control devices starting at the upstream end of the work zone and proceeding downstream.

NOTE

Removal of advance signs should not take place until all other devices are removed.

- Maintain an offset of 0.3 to 0.6 m between the flexible drums (barrels) and the edge of the travelled lane if possible.
- When placing a traffic control device, ensure that it is not obscured by other objects.
- Where there are multiple lanes in one direction and staggered signage is required on both the left and right shoulders: first, place the signs on the opposite shoulder from the lane that is being closed, and then place the signs on the same shoulder as the closed lane.
- Cover, turn, or remove signs and devices at times when they are not required. Remove the cover immediately before work at the work site begins.
- Ensure that the typical (or modified) layout is implemented as approved, record this information, and keep a copy available on site, as part of the traffic control plan and/or the traffic protection plan.

Removal

- Drive through the work zone before removal of traffic control devices to ensure that all workers are off the road, and that there are no gaps in the closure.
- Remove traffic control devices in the opposite order from which they were installed, starting with the closed lane(s), that is, the last barrel (or cone) installed is the first barrel removed. Advance signs are an exception, remove advanced signs on the left and right shoulders in a downstream direction, in the same order they were installed. Removal of advanced signs should not be done until all other traffic control devices are removed.
- Do not face work vehicles upstream when removing lane closures except in unusual circumstances; never face work vehicles upstream at night.

Additional principles for freeways:

Use a CT to protect workers who are installing or removing lane closures (except when 3.0 m or more from a live lane or installing or removing advance signage on shoulders wide enough to park on). Refer to [Section 5.5](#) for more information on CTs and their implementation.

- Position and maintain the CT at an LIDG distance (see Table D) upstream of workers when lane closures are being installed or removed.

- Install and remove freeway lane closures as quickly as possible, particularly the tapers.
- Back up the CT and work vehicles during removal of lane closures to provide protection for downstream workers. Do not back CT and work vehicles into a live lane of traffic.

NOTE

4.2.1 Set up of Freeway Lane Closures

The MTO has identified the set up and removal of freeway lane closures as operations that require special consideration. The best practices outlined in this section must be used for provincial freeway lane closure set ups and removals. The same procedures can be used on non-freeways, with or without a CT.

The Ministry and other road authorities may approve the use of alternative procedures or modifications of the procedures listed below to suit particular situations.

The Ministry and other road authorities may approve the use of alternative procedures to suit particular situations.

4.2.1.1 Freeway Closure of Single Right or Left Lane (with Shoulders)

The procedure described below is for a single right lane closure on a freeway with a full shoulder on the right side. The same approach, with appropriate modifications, is to be used for a single left lane closure on a freeway with a full shoulder. Where practicable, a rolling closure should be used as the alternative.

Preparation (Figure 3, Step A).

- Install signage on the shoulders in the advance warning and approach areas as outlined in the traffic control plan. A CT is not required to install signs on the shoulders if it will take less than 30 minutes and there is no encroachment into the adjacent traffic lane.
- A CT and a Sign Truck (ST) (with installers) that is pulling one TC-12 arrow board trailer are to be used.
- Position the CT on the right shoulder, approximately 1 to 2 km upstream of the beginning of the taper.

A CT is not required to install signs on the shoulders if it will take less than 30 minutes and there is no encroachment into the adjacent traffic lane.

NOTE

- Position ST with installers and a detachable TC-12 arrow board trailer in the left arrow mode on the shoulder at the beginning of the lane closure taper.

CT Enters the Roadway (Figure 3, Step B)

- When directed by the installers, the CT enters the traffic stream in the right lane with its flashing TC-12 arrow board in the left arrow mode and proceeds downstream. The CT gradually reduces its speed while monitoring upstream traffic to ensure that it is responding to the TC-12 flashing left arrow board.

Installing the Taper (Figure 3, Step C)

- When the CT is at an LIDG distance ([Table D Application of Longitudinal Buffer Area and Lateral Intrusion Deterrence Gap](#)) from the start of the taper, the installers may begin to retrieve barrels from the shoulder or vehicle and sequentially place them at the appropriate intervals specified in [Table C Work Zone Component Dimensions: Freeways](#) to form the taper. The installers move forward and install the barrels ahead of the sign truck.
- The CT shadows the ST at an LIDG distance in line with the position of the installers.

Completing the Taper and LBA (Figure 3, Step D)

- When the open lane width outside the taper becomes too narrow for the CT not to encroach into the adjacent lane, the CT drives through the barrels and continues to shadow the ST at an LIDG distance, moving parallel to the taper.
- As the last barrel of the taper is installed, the ST detaches its TC-12 arrow board trailer at the end of the taper and positions it in the lane that is being closed in left arrow mode and ensures 4WF/360° activated. Room is provided to ensure that the CT can pass the arrow board trailer on the right.
- The installers then begin to install the barrels for the LBA downstream of the ST. The CT moves downstream, maintaining a separation distance of LIDG to the ST.

Figure 3 Freeway Closure of Single Right or Left Lane (with Shoulders)

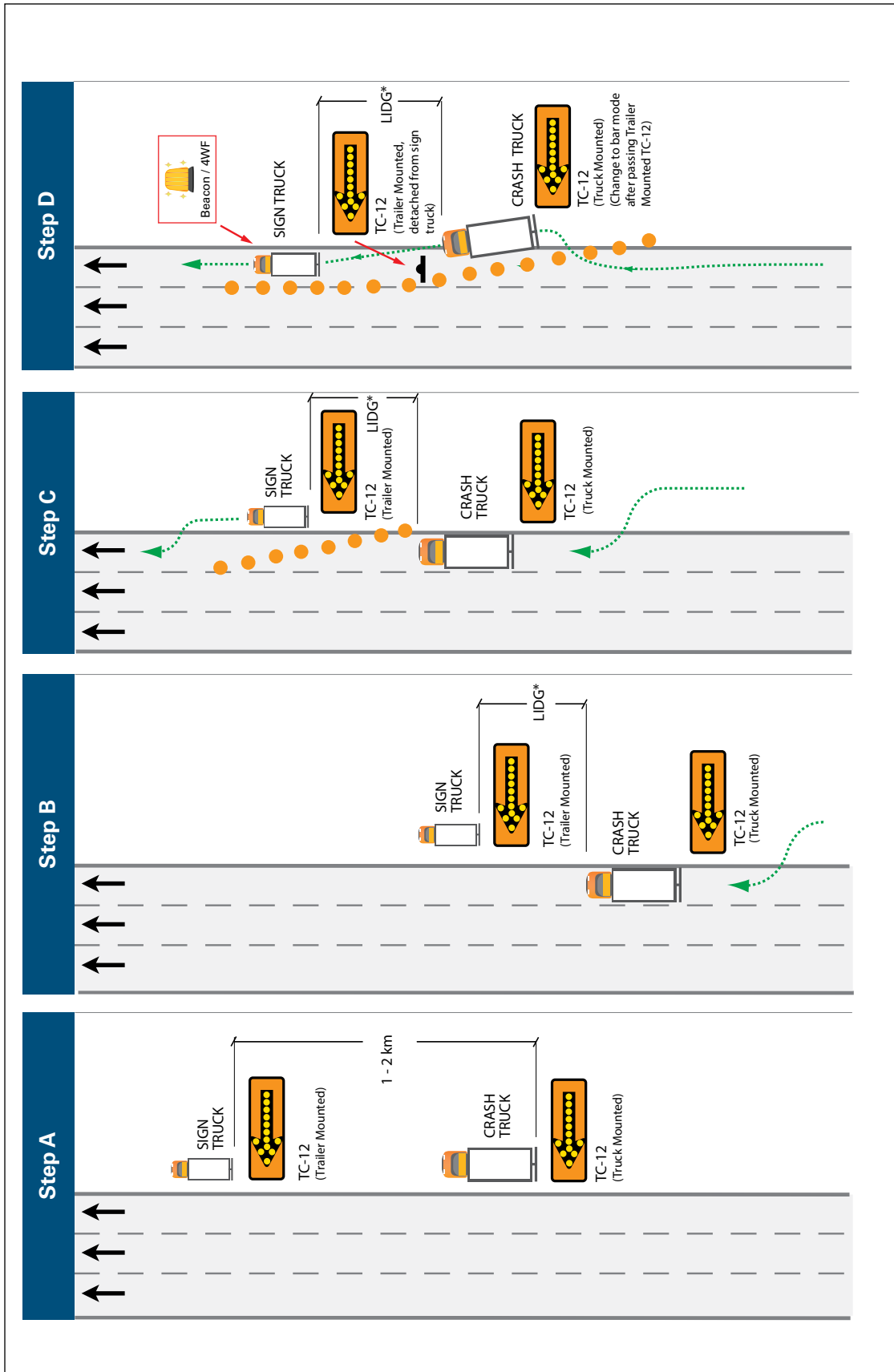

*See Table D

NOTE

- When the CT reaches the TC-12 arrow board trailer at the end of the taper, the BV drives around the trailer on the right and repositions itself at an LIDG distance from the ST in the lane being closed.
- The remaining barrels for the longitudinal buffer, work, and termination areas are installed in a downstream direction with the BV following the ST at an LIDG distance.

4.2.1.2 Freeway Closure of Two Right or Left Lanes (with Shoulders)

The procedure described below is for a two right lane closure of a freeway with full shoulders on the right. A similar approach with appropriate modifications is to be used for a two left lane closure with shoulders. Where practicable, a rolling closure should be used as the alternative.

Preparation (Figure 4, Step A)

- A CT and an ST (with installers) that is pulling one TC-12 arrow board trailer are to be used, along with a TC-12 trailer pre-positioned or towed in tandem on the right shoulder at the downstream end of the first taper.

First Taper and Tangent (Figure 4, Step B)

- The procedure detailed in section 4.2.1.1 above for a single right lane closure is used to install the first taper in the right-most (outer) lane. When the end of the right-most lane taper is reached, the TC-12 arrow board pre-positioned on the shoulder is brought over from the shoulder and positioned in the centre of the lane at the end of the taper in the left arrow mode.
- The installers then begin to install the barrels for the tangent or parallel section. The CT shadows the ST at a distance of LIDG.
- When the CT reaches the TC-12 arrow board at the end of the first taper, the CT drives around the TC-12 on the right, and repositions itself at an LIDG distance from the ST in the lane that is being closed.

Second Taper (Figure 4, Step C)

- The remaining barrels for the parallel section are installed in a downstream direction with the CT following the ST at an LIDG distance. A TC-3R is installed in the parallel section. A TC-4L is installed at the start of the second taper. The CT drives around the TC-3R and TC-4L on the right.
- When the parallel section has been installed, the installers place the barrels for the second taper. The CT shadows the ST at an LIDG distance. When the end of the second taper is reached, the ST detaches its trailer-mounted TC-12 and leaves it in the left arrow mode.
- After detaching the TC-12, the sign truck must ensure 4WF/360° activated.

Second LBA (Figure 4, Step D)

- The installers then begin to place the barrels for the LBA. The CT shadows the ST at a distance of LIDG. When the CT reaches the TC-12 arrow board trailer at the end of the second taper, the CT drives around the trailer on the right, and repositions itself at an LIDG distance from the ST.
- The remaining barrels for the longitudinal buffer, work, and termination areas are installed in a downstream direction with the CT following the ST at an LIDG distance.

NOTE

Figure 4 Freeway Closure of Two Right or Left Lanes (with Shoulders)

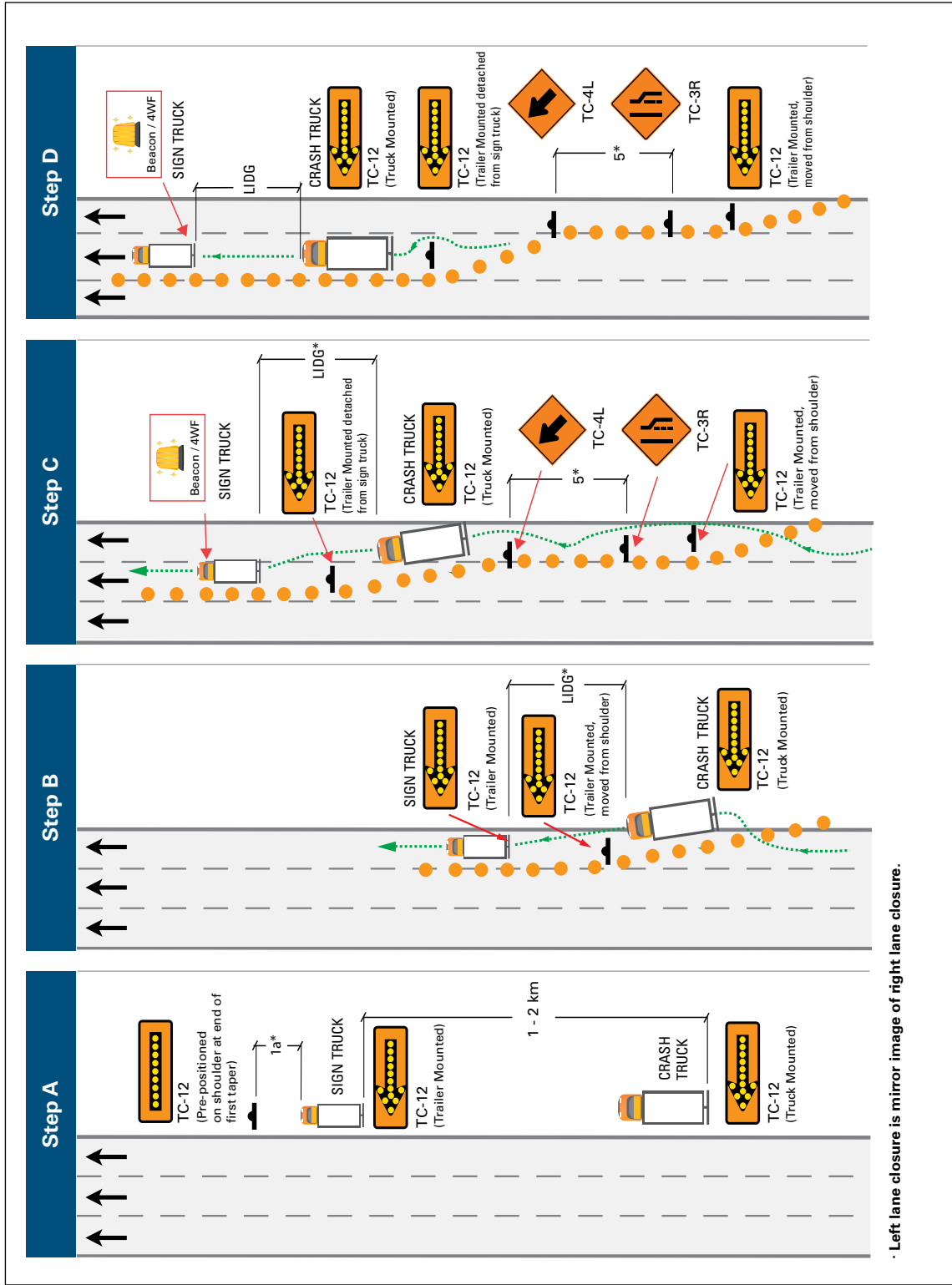

*See [Figure 5](#) and [Table D](#)

4.2.1.3 Freeway Closure of One or Two Right or Left Lanes (No Shoulder on Roadway Side where Lanes are being Closed)

NOTE

This procedure describes a freeway closure for two left lanes where the left shoulder is too narrow to permit a CT to use that shoulder to drive around a TC-12 sign trailer positioned in the adjacent lane. The approach is also used for a two right lane closure where the right shoulder is too narrow to permit a CT to use that shoulder to drive around a TC-12 sign trailer positioned in the adjacent lane. If only the left-most or right-most lane is to be closed, and there is a narrow or minimal shoulder, the procedures used are the same, although the steps related to the closure of the second lane are omitted and only one CT is required.

Preparation (Figure 5, Step A)

- Install signage on the shoulders in the advance warning and approach areas as outlined in the traffic control plan. A CT is not required to install signs on the shoulders if it will take less than 30 minutes and there is no encroachment into the adjacent traffic lane. Signage is installed either on both sides of the freeway if space permits, or on the right side of the roadway by using double signage.
- If the ST that is installing advance signage must encroach into the adjacent live lane, a CT must be used to protect the ST, located at an LIDG distance upstream of the ST.
- A convoy of lane closure work vehicles is positioned on the right shoulder or an on-ramp, approximately 1 to 2 km upstream of the beginning (upstream end) of the taper.
- Starting at the upstream end, the convoy consists of CT#1, CT#2, a ST with a TC-12 arrow board trailer and installers, and a work truck (WT) loaded with barrels.
- The WT is needed as the barrels cannot be placed on the left shoulder in advance of the lane closure operation as there is no shoulder, and not all of the barrels required can be carried in the ST.

NOTE

Positioning the Convoy (Figure 5, Step B)

- The convoy enters the traffic stream from the right side. The convoy then gradually changes lanes until it enters the left-most lane. The TC-12s on the ST trailer, CT#1 and CT#2, are in flashing bar mode until they enter the left-most lane, at which time the CT operators use their in-cab switches to change their TC-12s to the right arrow mode. The WT operates with the 360 beacon and four-way flashers activated. The convoy slowly decreases in speed.
- CT#1 and CT#2 monitor upstream traffic to ensure that it is responding to the flashing right arrow. If the traffic is responding, the convoy slows to a stop such that CT#2 is positioned at an LIDG distance upstream of the start of the taper. CT#1 stays at an LIDG distance upstream of CT#2.

First Taper and Tangent (Figure 5, Step C)

- ST and WT are positioned downstream of the start of the taper. The installers remove barrels from the ST and quickly install them for the first taper at the appropriate spacing provided in [Table C Work Zone Component Dimensions: Freeways](#). CT#1 and CT#2 move forward as the installers move forward. CT#2 maintains an LIDG distance upstream of the installers. CT#1 stays an LIDG distance upstream of CT#2
- CT#2 moves through the taper when the lane width outside the taper becomes too narrow for the CT not to encroach into the adjacent lane and maintains an LIDG distance upstream of the installers, as they continue to install the barrels and close the lane over a distance of 300 m (see Table C). CT#1 follows CT#2 through the taper when the lane width outside the taper becomes too narrow for the CT not to encroach into the adjacent lane.
- The whole convoy moves ahead and approaches the end of the first taper.

Second Taper (Figure 5, Step D)

- When CT#1 reaches the end of the taper, it parks at an LBA distance from the end of the taper with its TC-12 in the right arrow mode. The CT#1 driver/operator leaves CT#1 on the left and joins the installers.
- The barrels in the tangent or parallel section are then installed in a downstream direction with CT#2 following the installers at an LIDG

distance. The installers install a TC-3 in the parallel section as far to the right as possible. When CT#2 reaches TC-3, it passes TC-3 on the left.

- Once the parallel section has been installed, the installers begin to place the barrels for the second taper in the second lane. TC-4 is installed at the start of the second taper. CT#2 drives around TC-4 on the left and moves forward, parallel to the taper, maintaining an LIDG distance to the ST. When the end of the second taper is reached, the ST detaches its TC-12 trailer and installs it in the second lane in the right arrow mode.
- The ST then pulls into the left-most lane and moves downstream, leaving the installation area. CT#2 pulls to the left around the TC-12 arrow board trailer at the end of the second taper and back into the second lane that is being closed.

Second LBA (Figure 5, Step E)

- CT#2 maintains a distance of LIDG to the installers. The installers take barrels from the WT and place them to install the longitudinal buffer, work, and termination areas.

NOTE

Figure 5 Freeway Closure of Two Right or Left Lanes (No Shoulder on Roadway Side where Lanes are being Closed)

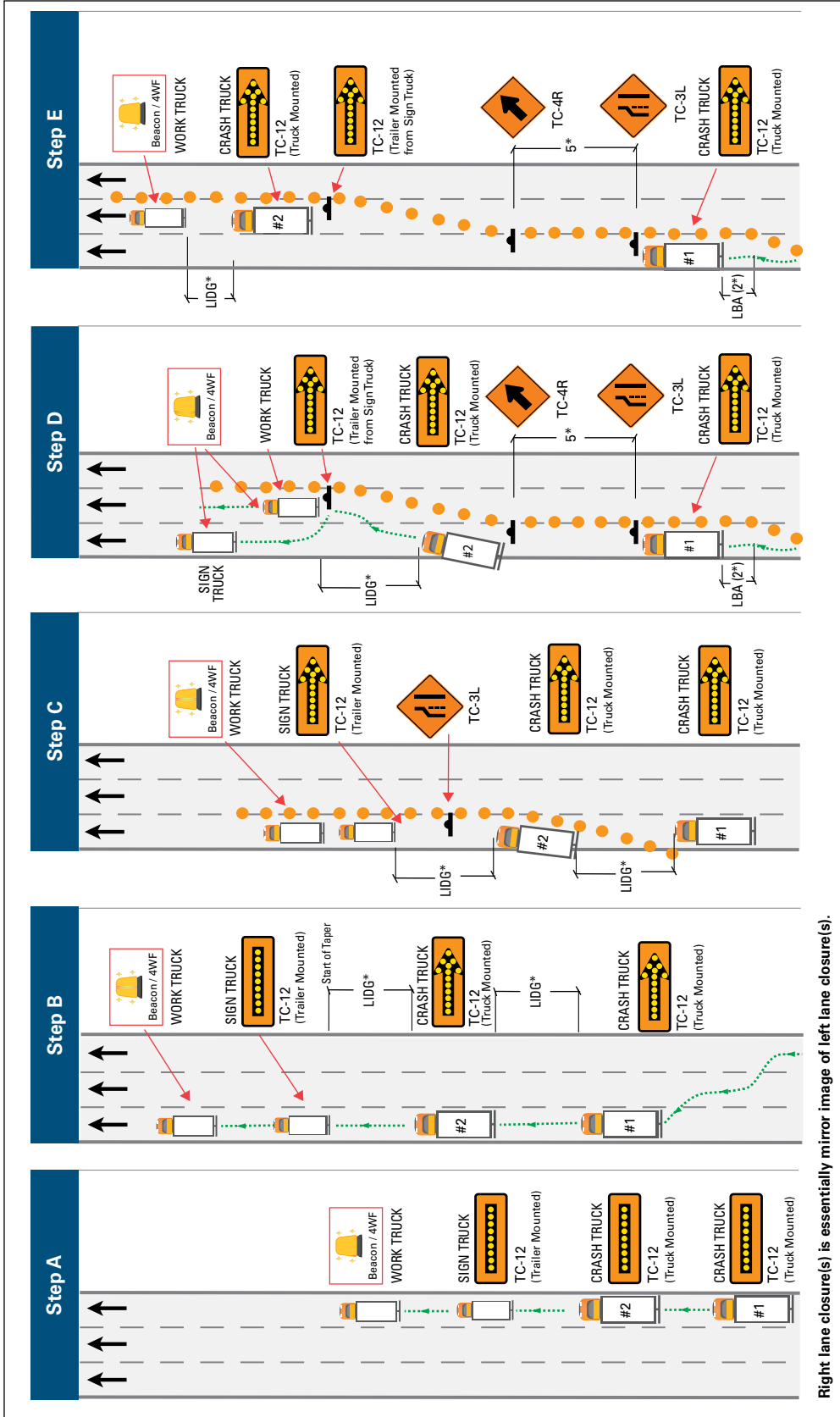

Note: On a freeway, drivers may not expect the high speed left (median) lane to be closed. To avoid confusing drivers during extended long duration left lane closures, the road authority may require the contractor to close the right-most lane(s) first, shift the traffic to the left lane(s), then re-open the right lane and close the left lane.

*See [Table C](#) and [Table D](#)

4.2.2 Removal (Take-down) of Freeway Lane Closures

4.2.2.1 Removal of Single Right or Left Lane Closure (Freeway with Shoulders)

The procedure described below is for the removal of a single right lane closure. A similar approach (with necessary and appropriate modifications) is to be used for the removal of a single left lane closure with shoulders.

Preparation (Figure 6, Step A)

- The ST and barrel installers (now removers) are positioned at the downstream end of the termination area, at the last barrel installed. The CT is located at an LIDG distance upstream of the ST. The removers work downstream of the ST.
- The traffic barrels are removed in the reverse direction that they were installed, so that the last barrel installed is the first removed. The barrels are set on the shoulder for later re-use or retrieval.
- The ST and CT slowly back up through the termination area, work area, and LBA as the barrels are removed, maintaining the same relative spacing and positioning throughout.

Removing the Taper (Figure 6, Step B)

- When the CT comes to the TC-12 trailer at the upstream end of the lane closure taper, it backs around the TC-12 on the right side and positions itself at an LIDG distance upstream of the TC-12. When the lane closure removers come to the TC-12, they place it on the shoulder for later retrieval.
- The CT then backs up parallel to the taper barrels on the downstream side of the barrels. The CT maintains an LIDG distance to the ST as the barrels are quickly moved to the shoulder by the removers.

Leaving the Construction Site (Figure 6, Step C)

- When the CT reaches the last barrel in the taper, it will be on the shoulder of the road. The last barrels are quickly moved to the shoulder as the CT backs up on the shoulder while maintaining an LIDG distance to the removers.

NOTE

- The ST and CT then proceed downstream to the next interchange. The ST circles around, drives downstream on the right shoulder, and retrieves the signs in the order that they were installed in the advance warning and approach areas by using a VSD operation. The ST then circles around and removes any advance signs on the left side of the roadway in a similar manner.
- Depending on the duration of the project, the barrels on the right shoulder may either be removed or left there for re-installation.

Figure 6 Removal of Single Right or Left Lane Closure (Freeway with Shoulders)

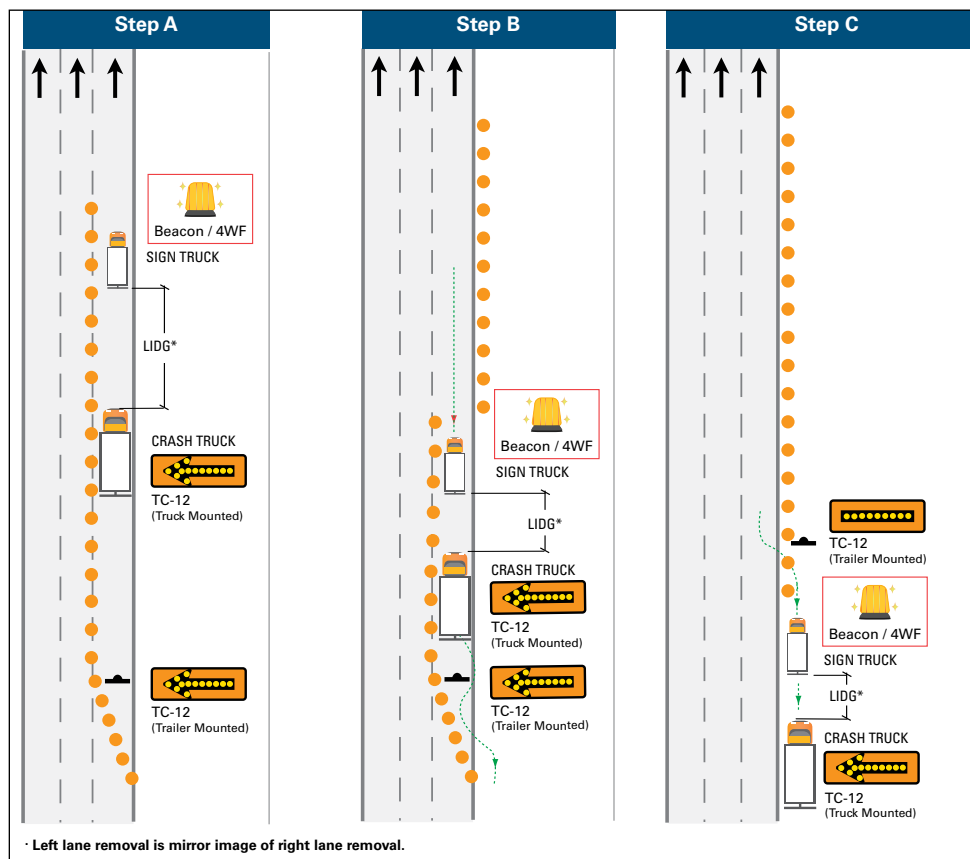

*See [Table D](#)

4.2.2.2 Removal of Two Right or Two Left Lane Closure (Freeway with Shoulders)

The procedure described below is for the removal of a two right lane closure with shoulders. A similar approach (with necessary and appropriate modifications) is to be used for the removal of a two left lane closure with shoulders.

Removing the Second Lane Tangent (Figure 7, Step A)

- The ST and the lane closure installers (now removers) are positioned in the right lane at the downstream end of the termination area, at the last barrel installed. The CT is located in the second lane upstream of the ST at an LIDG distance.
- The removers remove the barrels in the reverse direction that they were installed, so that the last barrel installed is the first removed. The barrels are set on the shoulder for later re-use or retrieval.
- The ST and CT slowly back up through the termination area, work area, and LBA as the barrels are removed. The CT maintains an LIDG distance upstream of the ST.

Removing the Second Lane Taper (Figure 7, Step B)

- The CT backs up until it comes to the TC-12 trailer at the upstream end of the centre lane closure taper. The CT backs around the TC-12 on the right side and positions itself at an LIDG distance upstream of the TC-12 in the centre lane taper. When the removers come to the TC-12, they place it on the shoulder for later retrieval.
- The CT backs up parallel to the taper barrels on the downstream side of the barrels. The CT maintains an LIDG distance to the ST. The removers work in front of the ST as the taper barrels are moved to the shoulder.
- When the CT reaches the last barrel in the centre lane taper, it backs down the parallel section with the ST at an LIDG distance downstream of the CT. The removers continue to remove the barrels, and as they approach them, the TC-4 and TC-3 signs are also taken away.

Removing the Right Lane Tangent and Taper (Figure 7, Step C and Step D)

- The rest of the lane closure removal is the same as the removal of a single right lane closure (see above, Section 4.2.2.1).

Figure 7 Removal of Two Right or Two Left Lane Closure (Freeway with Shoulders)

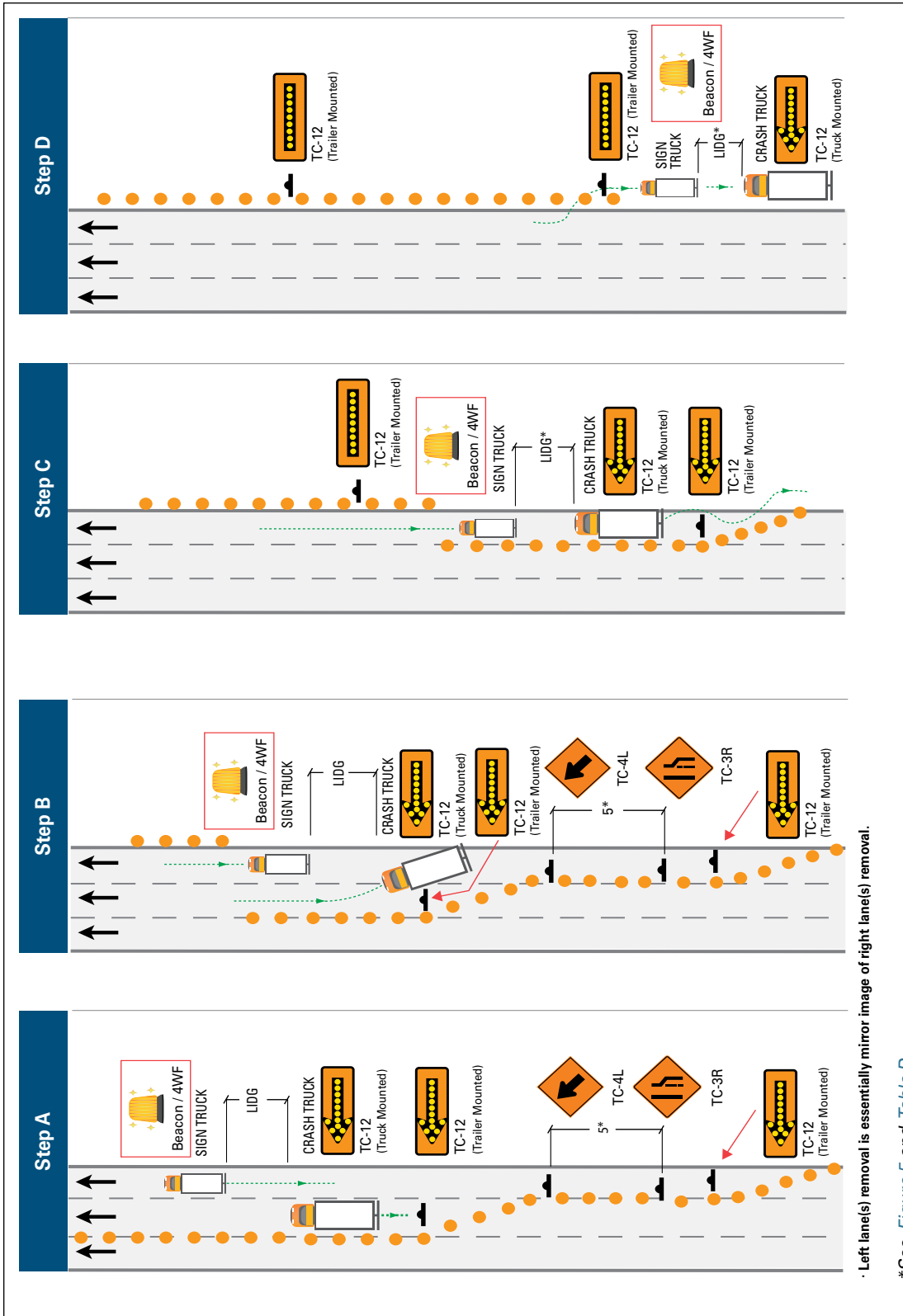

4.2.2.3 Removal of Two Right or Two Left Lane Freeway Closure (No Shoulder on Roadway Side where Lanes are being Closed)

This procedure describes the removal of a freeway closure of two left lanes where there is no shoulder or a minimal shoulder on the left side of the roadway. The procedure is similar to the removal of a freeway closure of two right lanes with no or minimal right shoulder. If only the left lane has been closed, the procedure is essentially the same, except that the steps related to the removal of the closure of the second lane are omitted.

Preparation (Figure 8, Step A)

- The lane closure installers (now removers) and the WT are located in the second lane at the downstream end of the termination area. CT#2 is located in the second lane at an LIDG distance upstream of the WT with its arrow board sign in arrow mode. A ST is located in the left-most lane beside CT#2.
- All three vehicles back up through the lane closure, maintaining the same spacing and positioning throughout as the removers remove the barrels in the reverse order that they were installed and place them in the WT.

Removal of TC-12, Second Lane Tangent and Second Lane Taper (Figure 8, Step B)

- When CT#2 reaches TC-12 at the downstream end of the second lane taper, it backs around TC-12 on the left side and positions itself at an LIDG distance upstream of TC-12 in the taper with its arrow board in the right flashing mode. The ST hooks up the TC-12 trailer and tows it out of the closure to a storage area with the arrow board collapsed and switched off.
- The lane closure removers then remove the second lane taper barrels and place them in the WT. CT#2 backs up parallel to the taper as the removers remove the barrels. CT#2 maintains an LIDG distance upstream of the WT.
- CT#2 backs around TC-4 into the parallel section with its TC-12 arrow board in the right arrow mode. The removers remove TC-4 and work upstream, removing the parallel section barrels.

Removal of Left Lane Tangent (Figure 8, Step C)

- As the removers remove the parallel section barrels, CT#2 backs up in the parallel section and around TC-3. The removers remove TC-3 and work

Figure 8 Removal of Two Right or Two Left Lane Closure (No Shoulder on Roadway Side where Lanes are being Closed)

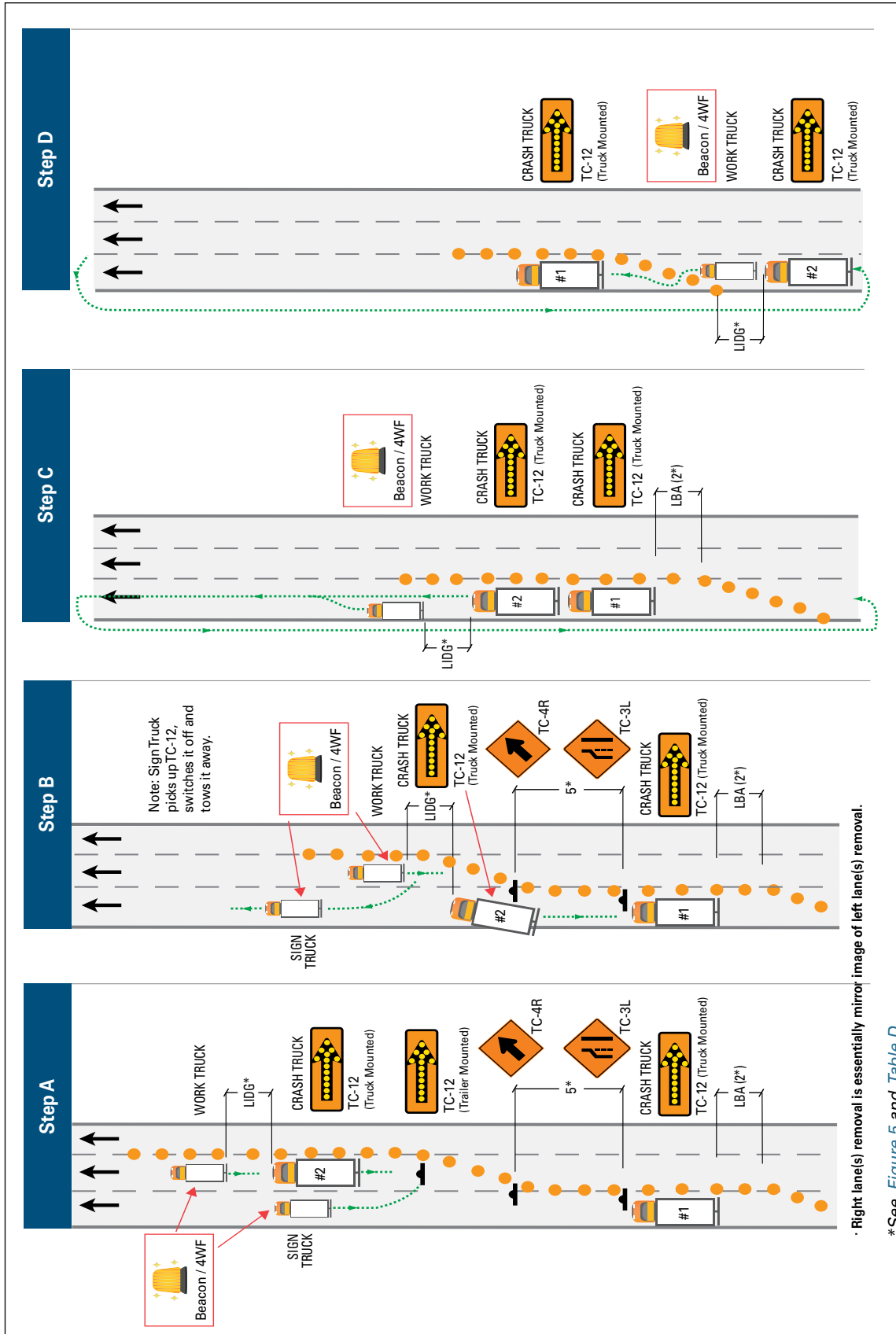

· Right lane(s) removal is essentially mirror image of left lane(s) removal.

*See Figure 5 and Table D

upstream, removing the parallel section barrels, until they reach CT#1 at the downstream end of the first taper.

NOTE

Removal of Left Lane Tangent and Taper (Figure 8, Step D)

- CT#2 and the WT leave the work area, turn around at the next interchange and circle back to the upstream end of the first taper. CT#2 slows to a stop in the left-most lane at an LIDG distance upstream of the start of the taper.
- The removers exit the WT on the left and quickly remove the barrels in the first taper and load them into the WT.
- CT#2 moves forward as the WT moves forward, maintaining an LIDG distance upstream of the WT.
- When the end of the first taper is reached, CT#1, the WT, and CT#2 move off in a convoy.
- The ST, protected by a CT that is shadowing it at an LIDG distance, picks up any advance signs on the left and right shoulders in a downstream direction.

4.3 Inspection and Documentation

The ongoing inspection of work zones is important to ensure that the appropriate traffic control devices are in place at all times.

- On any work project, the supervisor is responsible for keeping a record of traffic control used on site. For major projects, a separate field book should be maintained.
- Inspect the work zone by driving through it in the daytime and at night, as appropriate, after the temporary traffic control devices for the work zone are in place.
- Observe and record actions and reactions of drivers through the work zone (such as speeds, conflicts, late lane changes, frequent braking).
- Correct any problems as soon as possible.
- Document any changes to the traffic control plan or typical layouts, and the reasons for the changes, including those for any devices shown but not used, or used but not shown.

Ongoing inspection of work zones is important to ensure that the appropriate traffic control devices are in place at all times.

NOTE

- Inspect the work zone traffic control devices over the life of the project, as specified by the road authority (at least daily), while traffic control is in effect.
- Record in a daily journal, the traffic control devices used, including starting and ending times when they were in effect, locations, names of personnel, and the times of any moves.
- Replace and/or correct any inappropriate, damaged, knocked over, or displaced traffic control devices.
- Ensure that traffic control devices that are no longer needed, whether on a long-term or short-term basis, are either removed from the roadway, removed to the outside of the shoulder, covered, or turned, so that they are not visible to passing motorists.
- Monitor the queue and install additional advance warning signs if the end of queue is consistently beyond advanced warning signs.

The channelizing cones, markers, or flexible drums that are used for transition taper alignments may shift from their normal alignment and spacing if struck by vehicles or moved by wind and suction created by fast-moving trucks. It is therefore necessary to patrol the channelization at frequent intervals to ensure that it is properly functioning. On long-term construction projects, the repositioning of channelizing devices can be efficiently accomplished if the original taper alignment has been indicated by paint markings or removable marking tape has been applied onto the pavement.

Signs and other devices that have been damaged or defaced should be replaced immediately. Dirty signs and other devices result in poor visibility, particularly at night. ALL signs must be maintained in a clean, legible, and good working condition in order to be effective. (see [Section 7](#), for quality replacement guidelines)

After any collision, the status of the signs in the concerned area and the time of inspection shall be recorded and any necessary measurements or photographs taken as soon as possible.

Signs and other devices that have been damaged or defaced should be replaced immediately.

All signs must be maintained in a clean, legible, and good working condition.

5

Specifications for Devices to Control the Flow of Traffic and Devices to Provide Positive Protection

Section 5 provides specifications for devices to control the flow of traffic and positive protection devices and are as required for work on provincial highways and other roadways where MTO is the road authority. This section is to be used once devices have been identified based on the fundamental and guiding principles described in Sections 1 through 4, and/or through a typical layout. See [Section 3](#) for a general description of the devices and typical applications. Refer to [Section 6](#) for best practice procedures and specifications for channelizing, guidance and information. This section is particularly relevant to designers, contractors, and road authorities in preparing or ordering a schedule of devices, any person who is deploying the devices in reference to typical layouts, and supervisors or enforcement officers in evaluating the compliance of devices on site.

NOTE

Section 5 provides specifications for traffic control devices used on provincial highways and other roadways where MTO is the road authority.

5.1 Traffic Control With Moving Vehicles

Traffic control through the use of moving vehicles includes:

- the operation of **pilot** vehicles to guide road users, at an appropriate speed, through a complex one-lane section of a temporary traffic control zone or detour on a two-lane road;
- the operation of **pace** vehicles to control the speed of vehicles through a construction site, where reduced speed is necessary, but difficult to achieve by other means; and
- the short-term use of pace vehicles to provide a **rolling closure**. The pace vehicles hold back (restrain) all upstream traffic at a lower speed to create a time window of 5 to 15 minutes that is clear of all vehicles in which a work operation, such as making traffic control device layout changes, can be carried out.

Road authority approval is required to operate pilot or pace vehicles except when pace vehicles are used to provide a short term rolling closure for the set up or removal of traffic control devices. The use of pace or pilot vehicles should be decided by the road authority before contract tendering. It is the decision of the road authority whether to use the police, or its own staff and vehicles, or contractor staff and vehicles, or a combination of these.

NOTE

Road authority approval is required to operate pilot or pace vehicles except when pace vehicles are used to provide a short term rolling closure for the set up or removal of traffic control devices.

If forces other than the police are to be used for traffic control with moving vehicles, adequate and appropriate training must be provided to the staff who will operate these vehicles.

5.1.1 Pilot Vehicles

The operation of pilot vehicles must include traffic controls at each end of a one-lane section, such as TCPs, and one or two vehicles with communication links between all of them.

The pilot vehicle should move into the position at the head of the queue of vehicles about to be released by the TCP. When directed by the TCP, the pilot vehicle should guide the vehicles through the work zone (Direction 1). At the far end of the one-lane section, beyond the work zone, the pilot vehicle should pull over at the earliest safe opportunity, and signal the following queue to pass.

When the last vehicle of the queue clears the one-lane work zone section, the pilot vehicle in the other direction (Direction 2) should follow the same procedure as outlined above. Preferably, two pilot vehicles are used for this operation, one in each direction, to reduce motorist delay and driver frustration. Alternatively, if traffic volumes are low, the pilot vehicle in Direction 2 may be the same pilot vehicle as in Direction 1 (which turns around at the end of the work zone and takes its position at the head of the queue).

The pilot vehicle should display the name of the contractor or road authority. The DO NOT PASS WHEN FLASHING sign (TC-27) must be mounted on a conspicuous location on the rear of the vehicle. Where significant queuing occurs or is expected to occur, or visibility at the end of the queue is insufficient, the PREPARE TO STOP sign (TC-20 or TC-20A) should be used upstream of the expected end of the queue.

Two or more pilot vehicles may be used to guide two-way traffic through a particularly complex detour.

Work vehicles that enter the work zone should be managed by the TCP so that they are the last vehicle(s) in the queue, to avoid other vehicles following them into the work area.

5.1.2 Pace Vehicles

For the safe deployment of pace vehicles:

- Advance signing that warns of possible stops and/or of the use of pace vehicles should be provided in low volume situations with vehicles that approach at high speed.
- Advance signing that warns of possible stops and/or of the use of pace vehicles should be provided where significant queuing and congestion are expected.
- The DO NOT PASS WHEN FLASHING sign (TC-27) must be mounted in a conspicuous location on the rear of each non-police pace vehicle.
- The pace vehicle(s) must lead at a reasonable speed. The speed differential between vehicles that are approaching the work zone from upstream to the last vehicles in the queue must not create a collision hazard. A realistic speed reduction is 10 to 15 km/h below the normal regulatory posted speed.
- Good communication among pace vehicles is essential for good traffic control.

Pace vehicles should only be used where there is a single lane through the work zone. One or more vehicles may be necessary to pace traffic through one or more lane closures to reach the single lane section.

The pace vehicle(s) (one per lane) will enter the free flowing traffic upstream of the first lane closure and downstream of any on ramps. The vehicles will gradually reduce speed and align with each other to prevent drivers from changing lanes to get in front of the pace vehicles.

At the end of the taper, the pace vehicle in the closed lane should merge into the traffic behind the pace vehicle in the remaining open lane.

Determining the Number of Pace Vehicles Required

Sufficient pace vehicles are required to provide continuous speed reduction to avoid end of queue collisions within a work zone. When the last vehicle in a queue has entered the work zone, a pace vehicle(s) must be in place to lead and pace the next vehicles through the work zone. This means that the time to traverse the work zone, plus the time required to circle back and take posi-

NOTE

Pace vehicles should only be used where there is a single lane through the work zone.

NOTE

tion back in the traffic stream, must be considered. The number of pace vehicles required can be calculated as follows:

$$PV = N \times (\text{Cycle Time} / \text{Work Zone Traversal Time})^*$$

where:

PV = the number of pace vehicles needed

N = the number of lanes in the direction of interest in advance of any lane closures (assuming that only one lane is left open to traffic in the work zone).

**Work zone traversal time is the time required to drive through the work zone at the pace vehicle speed. Cycle time is the time required for a given pace vehicle to drive through the work zone, plus the time required to circle back to start another run through the work zone. The cycle time will be affected by traffic volume, and characteristics of the road network; that is, how directly and quickly a pace vehicle can drive around and return to the beginning of the work zone.*

For example, consider an operation with three lanes that are being progressively closed down to one, with a work zone traversal time of 10 minutes, and a return time of 20 minutes from the end of the work zone back to the beginning. To avoid the risk of fast vehicles closing in on slow vehicles in the work zone, a new set of three pace vehicles will be required every 10 minutes.

$$N = 3 \text{ lanes}$$

$$\text{Work Zone Traversal Time} = 10 \text{ mins}$$

$$\begin{aligned} \text{Cycle time} &= 10 \text{ mins (Work Zone Traversal Time)} + 20 \text{ mins (return} \\ &\quad \text{time)} \\ &= 30 \text{ mins} \end{aligned}$$

$$\begin{aligned} PV &= 3 \text{ lanes} \times (30 \text{ mins}/10 \text{ mins}) \\ &= 9 \text{ pace vehicles.} \end{aligned}$$

Determining the Quantity of Pace Vehicle Hours Required

Since the purpose of pace vehicles is to control traffic speed, they are not required during periods when traffic congestion alone results in traffic speeds at or below the desired speed. Continuous observation of traffic conditions must be

maintained so that pace vehicles can be promptly re-introduced into the traffic stream when congestion eases and speeds increase.

To estimate the quantity of pace vehicle hours required over the duration of a contract:

- Determine the number of pace vehicles needed (PV) (as explained above).
- Calculate the number of hours that the pace vehicles are required (hr) as the total hours that a reduced speed is desired minus the hours during which congestion alone results in speeds of 15 km/h or more below the normal regulatory posted speed.
- Pace vehicle hours = number of pace vehicles x hr

If there are multiple stages within a contract, the number of pace vehicles and hours required will need to be calculated for each unique configuration. The total pace vehicle hours required for the contract will be the sum of individually calculated pace vehicle hours for each configuration.

5.1.3 Rolling Closures

Contractor vehicles may be used as the pace vehicles in a rolling closure; however, driver compliance is likely to be higher when controlled by a police vehicle. Police vehicles are recommended on freeways and are required on MTO freeways. Where available, arrangements should be made to use a police vehicle, in particular, on urban high volume freeways. The DO NOT PASS WHEN FLASHING sign (TC-27) must be mounted in a conspicuous location on the rear of all non-police pace vehicles used in a rolling closure.

Prevention of traffic moving past the rolling closure is critical to ensure worker safety. Communication between the pace vehicles and the downstream workers must be in place to alert workers if the closure has been breached.

One of the following two approaches for rolling closures should be used:

(1) Urban high volume freeways with frequent interchanges

Drivers are generally accustomed to frequent congestion on urban high volume freeways and it is neither desirable nor practicable to prevent vehicles from entering the highway at all upstream entrance ramps.

The rolling closure operation is initiated by sufficient lead pace vehicles that are travelling abreast, one vehicle per lane, several kilometres upstream of

NOTE

Pace vehicles are not required during periods when traffic congestion alone results in speeds below the desired speed.

Prevention of traffic moving past the rolling closure is critical to ensure worker safety.

NOTE

the closure site, to control the flow and speed of traffic that is approaching the closure site. As they approach the site, they gradually reduce their speed, allowing traffic ahead (downstream) of them to clear the work zone at a normal speed. After they pass the entrance ramps of the last upstream interchange, the pace vehicles continue to reduce their speed, coming to a complete halt if necessary, just upstream of the closure site, to create the necessary time window. The slowing and stopping of the pace vehicles should be progressive and gradual so that drivers will have time to adjust to the situation, as in a similar congestion situation. When the work at the closure site is complete, the pace vehicles turn off their flashing lights and allow traffic to resume normal flow.

(2) Rural low volume freeways with infrequent interchanges

Drivers expect free flow conditions on rural low volume freeways. A sudden requirement to come to a halt would violate driver expectation and present a hazard. Therefore, the pace vehicle(s) should lead at a planned speed reduction of no more than 15-20 km/h below the NPRS. The use of advance warning signs, such as the PREPARE TO STOP sign (TC-20), should be considered.

The distance upstream of the work zone where the rolling closure operation will have to be initiated must be carefully calculated. The point of initiation must be further upstream than the distance travelled by the pace vehicles, at the planned speed, in the total time required to:

- i. clear the last unrestrained vehicle from the work zone, and
- ii. perform the work, and
- iii. clear workers from the roadway.

This distance may be as great as 15 to 25 km. This means that a rolling closure is unlikely to be suitable in all situations, but must be carefully tailored to the road configuration and network involved.

The rolling closure operation is initiated by sufficient lead pace vehicles that are travelling abreast, one vehicle per lane, to control the flow and speed of traffic that is approaching the closure site. As they approach the site, they gradually reduce their speed, allowing traffic ahead (downstream) of them to clear the work zone at a normal speed.

As the rolling closure is approaching the work zone, all entrance ramps at the intermediate interchanges must be closed until the rolling closure has passed to

On rural low volume freeways, the pace vehicle should lead at a speed no less than 15-20 km/h below the NPRS.

prevent vehicles from entering the clear zone ahead of the lead pace vehicles. If the rolling closure starts more than one interchange back, it may be desirable for the lead pace vehicles in the rolling closure to drive at a speed closer to the normal posted speed until they have passed the last interchange, and then decelerate to a lower speed when it is no longer possible for entrance ramp traffic to pass them or enter ahead of them. It is essential that **all** work vehicles involved in the rolling closure, including lead pace vehicles, vehicles at intermediate interchange entrance ramps, and at the work area itself, be in good communication with each other to alert workers if the closure has been breached.

When the work operation is completed, the lead pace vehicles may speed up at or beyond the work zone, and merge into one lane, permitting other traffic to pass them. If the work operation includes the set up of a lane closure, the lead pace vehicle in the closed lane should merge behind the lead pace vehicle in the open lane at the end of the taper.

In some circumstances, it may be necessary or desirable to bring vehicles to a very low speed or even to a stopped position. This need may arise if operations at the work area run into unexpected difficulties and require more time. Where very low speeds or stops are planned or can be reasonably anticipated to be required, advance signage, such as the PREPARE TO STOP sign (TC-20), should be used.

NOTE

All work vehicles involved in the rolling closure should be in good communication to alert workers if the closure has been breached.

5.2 Use of Traffic Control Persons (TCPs)

The responsibilities of TCPs when performing work zone traffic control are to:

- protect construction workers and the motoring public by safely regulating traffic flow and directing traffic through a work zone;
- stop traffic whenever required by the progress of the work; otherwise, keep traffic moving at reduced speeds to avoid tie-ups and delays;
- allow construction to safely and efficiently proceed;
- warn workers of impending danger;
- ensure that public traffic has priority over construction equipment; and
- focus on the traffic control task and not perform other work while directing traffic.

It is mandatory that adequate safety precautions are taken to protect TCPs from any particular hazards to which they may be exposed. Safety precautions include

NOTE

Adequate safety precautions must be taken to protect TCPs from hazards.

TCPs must be given written and oral instructions about their duties in a language that they can understand.

personal protective clothing, equipment and devices, appropriate training, and any additional protective measures necessary to mitigate risks imposed by vehicular traffic. The safety of TCPs must be addressed during the planning stages of traffic control. The appropriate equipment, clothing, training requirement, and duties of a TCP must be as prescribed in the OHS Act and are outlined in the following sections.

5.2.1 Qualifications and Equipment

The general qualifications of a good TCP include:

- sound health, good vision and hearing, mental and physical alertness;
- mature judgement and pleasant manner;
- ability to judge speed and distance of oncoming vehicles;
- compliance with the OHS Act requirement of a competent worker;
- preferably possession of a valid driver's licence;
- the ability to give motorists simple directions, explain hazards, and answer questions; and
- like, understand, and respect the responsibilities of the job.

TCPs must be given written and oral instructions about their duties in a language that they can understand.

Clothing

A TCP must wear a garment with reflective materials, which meets the requirements of Ontario Regulation 213/91 Section 69.1 under the OHS Act.

The TCP also requires:

- a hard hat that is Canadian Standards Association CSA certified Class E – Type I or II hard hat. If used at night, the hard hat must have reflective tape that does not alter the dielectric properties of the safety hat and is visible from all angles (minimum of 80 cm² recommended);
- safety boots that are CSA-certified, Grade 1 (green triangular CSA patch on the outside, green rectangular label on the inside); and
- eye protection, e.g., clear safety glasses for night or overcast, tinted safety glasses when sunny, consider goggles for extreme dust and wind.

5-30m

Tools

For hand signalling, the standard TC-22 traffic control sign (STOP/SLOW paddle, see [Section 6](#) for description) with an extension handle must be used by TCPs to direct traffic. The use of flags is prohibited. [Figure 9 Traffic Control Person Use of STOP/SLOW Paddle](#) illustrates the TCP use of the STOP/SLOW paddle.

Figure 9 Traffic Control Person Use of STOP/SLOW Paddle

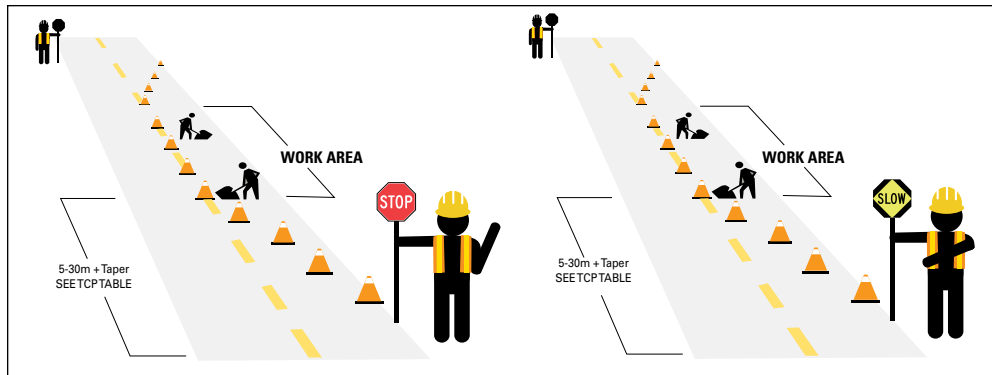

TCPs must be positioned, and operate, in a manner which will not conflict with other traffic control devices.

A two-way communication device is recommended depending on the situation.

For night-time traffic control TCPs also require:

- A well-lit TCP station. Night-time traffic control requires proper and adequate illumination. Illumination from above is generally more effective than from the side.
- A TC-22 and a flashlight with a red or orange cone attachment with spare batteries.
- A two-way communication device. Voice activated radios are recommended so as to free the TCPs hand for using the stop/slow paddles and flashlight simultaneously.
- Advance warning signs may be enhanced with amber beacons when TCPs are used at night.

A TC-22 stop/slow paddle with either one or two red lights that are vertically installed and centred above and/or below the STOP legend may be used as an optional enhancement to the standard TC-22. The alternating flashing red light(s) are to be briefly activated by the TCP as vehicles approach to enhance conspicuity. As well, consider using remote control devices or PTTS in high risk situations.

NOTE

A TCP should not be positioned, or operate, within 30 m of an intersection with active traffic control signals.

The turning off of signals must be approved and executed by the road authority.

When a TCP is not present including lunch and other breaks the TC-21 sign must be removed or covered.

5.2.2 TCP Position and Location

When a TCP is on duty, the TC-21 sign must be used at all times. The TC-21 sign must be removed when the TCP is not on duty. The sign is placed in advance of the TCP at the distance shown in an appropriate typical layout in [Section 8](#).

TCPs must be positioned, and operate, in a manner which will not conflict with other traffic control devices, such as stop signs, traffic signals, or railway crossing signals. Sufficient vehicle storage should be available between an intersection and the TCP to accommodate expected queues without extending into an intersection with active signals. Generally, a TCP should not be positioned, or operate, within 30 m of an intersection or any location with active signals. If this is not possible, either the traffic signal should be turned off and TCPs positioned at each leg of the intersection, or the police should be brought in to control traffic. The turning off of signals must be approved and executed by the road authority. A contractor must not turn off signals themselves to allow the use of TCPs at an intersection. TCPs must be clearly visible to the approaching motorist at all times. The TCP should be located for good conspicuity and contrast. Other illuminated or reflective objects should not distract the visual attention of motorists away from the TCP. Colour contrast should be maintained between the TCP and the background, to the extent possible. The TCP should not stand in the shadow or where the sun impedes visibility. Typical TCP locations are shown in [Figure 10 Positioning of Traffic Control Persons](#) for straight road, hill, and curve situations, and in the typical layouts in [Section 8](#).

TCPs must also:

- be alert, standing at all times while on duty;
- face oncoming traffic, and not turn his/her back on moving traffic;
- stand alone, and not mingle with workers or the public;
- stand just outside the lane of traffic;
- stand from 5 to 30m in advance of the first cone of the transition taper (see [Table 2 Traffic Control Person Placement \(TCP Table\)](#)), so as to be able to protect workers and equipment;
- stand where s/he can be seen to give approaching traffic adequate time to respond, and where s/he can see for 150 m;
- remove or cover all signs that indicate a TCP (TC-21) when a TCP is not present to control traffic, including lunch and other breaks;

- not perform any other work while directing traffic;
- be alert for emergency vehicles, which have “priority rights,” and allow them to pass as quickly as possible; and
- coordinate his/her operations with any nearby traffic control signal systems and railway crossing signals, and not override or conflict with them.

Figure 10 Positioning of Traffic Control Persons

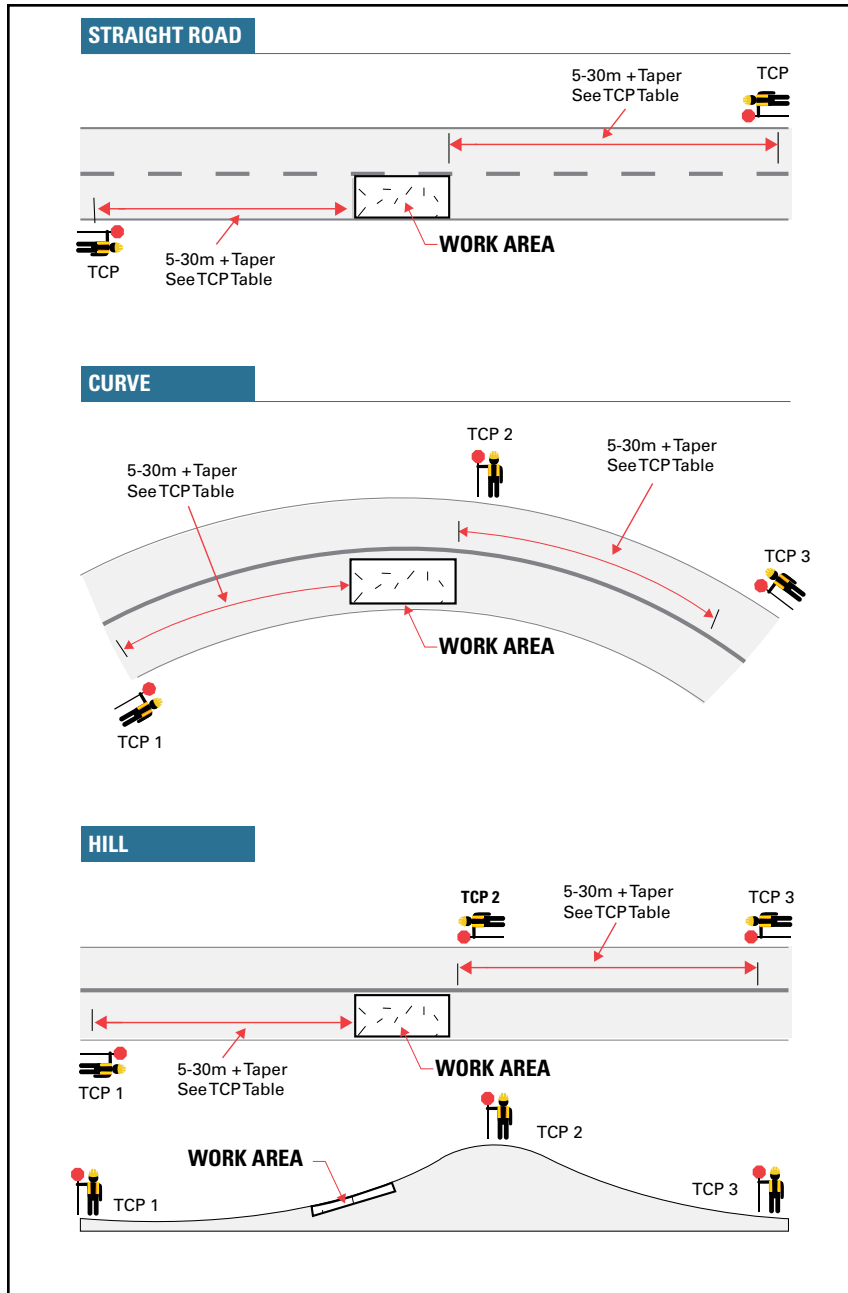

NOTE

A single TCP may be used to control traffic in work areas where the length of the closed lane is short (up to 50 m), traffic volumes and speeds are low, and visibility is good, and in daylight hours only.

5.2.3 TCP Control Procedures

When stopping traffic, the TCP must display the STOP sign to the motorist, extend the traffic control sign into the lane of oncoming traffic, and give the motorist enough warning for a safe and comfortable stop. The TCP must stand off the travelled portion of the roadway until the first vehicle has come to a stop. When traffic has stopped, the TCP may move to a point on the road where traffic in the queue can see him/her. Before moving traffic from a stopped position, the TCP must ensure that the opposing traffic has stopped and that the last opposing vehicle has passed his/her post.

When slowing traffic, the TCP must display the SLOW sign, slowly moving the sign back and forth, if necessary, using hand signals to wave traffic forward or to command a further reduction in speed.

The most typical TCP situation involves two TCPs. When two TCPs are required, lines of communication must be established prior to the start of operations. The two TCPs must be able to see each other or have two-way radios for proper communication. One TCP should be the lead TCP and coordinate all activities. When using visual communications on curves or hills, a third TCP may be required to relay signals between the two TCPs at the ends of the work area.

A single TCP may be used to control traffic in work areas where the length of the closed lane is short (up to 50 m), traffic volumes and speeds are low, and visibility is good, and in daylight hours only. This may only be done in such a way that it is effectively one-way control, such as where traffic in one direction has an unobstructed lane, and the TCP holds traffic in the obstructed lane until the unobstructed lane is clear of traffic. In this one-way control situation, the TCP serves the same function as the YIELD TO ONCOMING TRAFFIC sign.

Table 2 Traffic Control Person Placement (TCP Table)

| Normal Regulatory Posted Speed | 60 km/h or lower, one lane or reduced to one lane | | 70 km/h to 90 km/h, one lane or reduced to one lane | |
|---|---|-----------|---|-----------|
| | Low | High | Low | High |
| Traffic Volume | | | | |
| Distance of TCP from First Cone of Transition Taper | 5 – 10 m | 10 – 15 m | 15 – 25 m | 20 – 30 m |

5.3 Application of Signal Systems

NOTE

5.3.1 Automated Flagger Assistance Devices (Remote Control Device)

Automated flagger assistance devices (AFADs) are not identified in the HTA, only in OTM Book 7 as an electro-mechanical device that is remotely controlled and performs the function of a TCP in a two-way, one lane traffic operation. It is considered as a supplement to a TCP and not a temporary traffic signal or a Portable Lane Control Signals (PLCS). Legal approval for installation is not required as it is not covered under the HTA.

AFADs do not use the traditional traffic signal head that has red, amber and green lenses, but rather one with only red and amber lenses in conjunction with a control arm to control traffic.

The remote control device may only be used to control one lane two way operations. Where AFADs are used, the following application guidelines must be met:

- AFADs are to be used only in situations where TCPs are used, that is, for the control of two-way traffic on two-lane highways reduced to one lane during VSD or SD work.
- The AFADs must not use a traffic signal head with red, amber, and green lenses.
- A red display, together with a control arm, will be used to stop vehicles from entering a one-lane section. When the TCP wishes to allow traffic to enter the one-lane section, the red display will turn off, the amber display will flash, and the control arm will be raised. When the TCP wishes to stop vehicles again, the amber display will go from flashing to solid for four to six seconds, before the red display appears and the control arm is lowered.
- A TCP must be nearby, in a safe location away from live traffic, and where practicable, at least 3.0 m off the roadway, and controlling the AFADs.
- If two AFADs are used, one at each end of a work area, communications between the signals at each end must be provided in order to prevent conflicting displays.
- On longer work areas (from 50 to 500 m), two TCPs must be used, in communication with each other, one at each end, and controlling the AFADs at that end.

When a AFAD is used a TCP must be nearby, in a safe location away from live traffic, and where practicable, at least 3.0 m off the roadway, and controlling the AFADs.

NOTE

- On shorter work areas (50 m or less), if only one TCP is controlling two AFADs, there must be a failsafe mechanism to ensure that both ends of the one lane section will not receive a flashing amber display at the same time.
- The TCPs must be equipped with STOP/SLOW paddles, readily available in case of failure.
- Traffic must be channelled into a single lane in advance of the AFADs, by means of cones, barrels, and an Rb-25 (KEEP RIGHT sign).
- Signing for use of the AFADs must be in accordance with TL-20B.
- Proper illumination is required when AFADs are used for night-time activities.
- If the contractor leaves the site, this equipment must be removed and two way flow of traffic resumed.

5.3.2 Portable Lane Control Signals (PLCS)

The use of PLCS is an alternative to continuous flagging by TCPs, and not to be confused with PTTS.

PLCS may only be used if all of the following conditions are met:

- the normal posted regulatory speed is 60 km/h or less;
- to control one lane, two way traffic flow;
- for VSD or SD work;
- full illumination exists if the closure continues at night;
- not at an intersection or pedestrian crossover; and
- no conflict with any existing signals or traffic control systems.

PLCS systems consist of at least one vehicle traffic signal head, normally mounted on movable poles/trailers at a minimum height of 2.75 m from the roadway surface to the bottom of the heads as shown in [Figure 11 Portable Lane Control Signal](#). It is recommended that PLCS with two signal heads be used, where practicable, and that the second signal head be located in the standard secondary head location.

The use of PLCS is an alternative to continuous flagging by TCPs, and not to be confused with PTTS.

Figure 11 Portable Lane Control Signal

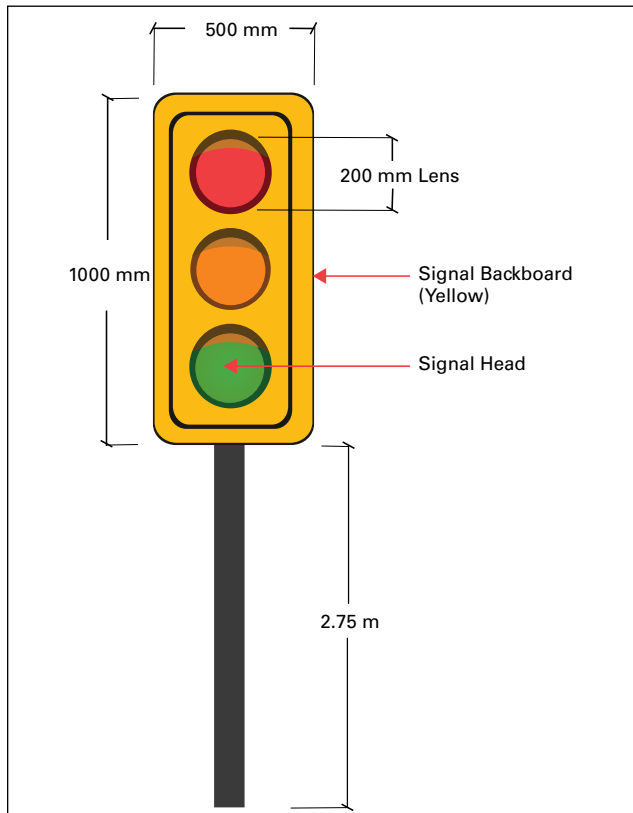

The phasing must be two phase only, with the all red clearance interval sufficiently long to clear the previous approach lane of all vehicular traffic while travelling at the desired operating speed. Communication between the signal heads on opposite ends of the lane closure must be provided in order to prevent conflicting displays. Should conflicting displays occur, the system must ensure that both directions receive a solid red signal indication. [Figure 12 Signal Timing Calculations](#)

NOTE

[Example](#) provides an example of signal timing calculations. Further information can be found in OTM Book 12.

PLCS must be placed to the right of and facing traffic, and used only under conditions where the signal lights are clearly visible to an approaching motorist such that the vehicle can be brought to a safe stop at the expected approach speeds. Intensity of the signal lamps must be maintained in such manner that the lights are clearly visible for a distance of at least 100 m (minimum requirement in the HTA). Recommended signal visibility distances vary with posted speed as shown in [Table 3 Signal Visibility Table](#).

NOTE

Table 3 Signal Visibility Table

| Posted Speed (km/h) | Minimum distance from which signal must be clearly visible |
|---------------------|--|
| 60 | 110 |
| 70 | 140 |
| 80 | 170 |
| 90 | 200 |

Access points or side streets within the one lane section controlled by the PLCS must be controlled by TCPs who are working in conjunction with the equipment.

This equipment must be removed and two way flow of traffic resumed whenever the contractor leaves the site.

PLCS must be installed in accordance with the requirements of Regulation 606 in the HTA, which covers the physical and signage requirements for these devices. The signal system must be preceded by the following three signs: Rb-31 DO NOT PASS, TC-23 SIGNALS AHEAD, and Rb-78 STOP HERE ON RED SIGNAL. See [TL-21](#) and Table A or B in [Section 8](#), for the required placement. Driver action is prescribed in Section 146 of the HTA.

Due to the temporary nature of these devices, legal drawings are not required by law.

5.3.3 Portable Temporary Traffic Signals (PTTS)

PTTS consist of two standard traffic signal heads mounted on movable trailer.

PTTS may be used as an alternative to TCPs. The trailers are typically positioned at intersections to emulate traffic control or are used as lane control signals for VSD or SD work on roadways with a normal posted regulatory speed greater than 60 km/h or long duration work. The road authority must approve the use of this device. For MTO projects, the Ministry’s Regional Traffic Office must approve the use of a PTTS system and all signal timing plans on a project-by-project basis.

The MTO requires a PHM-125 drawing to be completed for each stage of construction with a unique location of the trailers, traffic signal heads, stop blocks, signal related signs and pavement markings, and placement of barrier or detection devices.

For VSD and SD work, PTTS must be installed in accordance with the requirements of Regulation 606 in the HTA, which covers the physical and signage

PTTS may be used as an alternative to TCPs.

requirements. Driver action is prescribed by Section 146 in the HTA. For long duration work, PTTS must be installed to meet the requirements of Regulation 626 and Section 144 in the HTA.

Other traffic control devices are required to supplement PTTS, including warning signs, regulatory signs, temporary pavement markings and/or channelizing devices.

If PTTS are to be used, there must be adequate visibility/sight distance as per [Table 3 Signal Visibility Table.](#), without the use of auxiliary heads.

PTTS may not be used if a side street or access point is within a one lane section (temporary signals with multiple phasing must then be used).

PTTS systems must not be located in any place or manner so as to conflict with any existing signals or traffic control systems.

Conventional temporary traffic signals, such as SWTTS, must be used instead of PTTS at entrances, truck access routes, or pedestrian crossings. If time of day functions are required due to known variances in traffic patterns (i.e., different maximum green times due to long weekend traffic patterns), a conventional temporary traffic signal is required.

If night-time use is required, illumination must be provided such that, as a minimum, the decision points on the approach to each end of the work zone where the signal heads are located are illuminated. This may be accomplished with portable generator powered lights that must be a minimum of 9.0 m in height from the road surface. The illumination provided by each light source shall be a minimum of 22,000 lumens, and must not produce glare to oncoming motorists.

PTTS should only to be used on long duration work for a maximum of 8 months (April – November), as maintenance and reliability concerns have been identified during the winter months. Outside of this period, the operation should return to normal two way traffic flow.

If used for long duration work, a cost comparison is recommended to show that it is more cost effective to use solar powered PTTS as opposed to regular temporary traffic signals.

PTTS trailers must:

- be strategically located so that they are protected from moving traffic;

NOTE

PTTS may not be used if a side street or access point is within a one lane section.

NOTE

When two PTTS are used within the same work zone, the maximum spacing recommended between the devices on a two-way, one-lane operation is 400 m.

- offer resistance to displacement or damage by moderate to severe weather, vehicle impact, and vandalism; and
- be positioned in such a manner that the one signal head is adjacent to the roadway while the other signal head is at least 0.5 to 1.75 m into the approach lane.

When two PTTS are used within the same work zone, the maximum spacing recommended between the devices on a two-way, one-lane operation is 400 m.

Where pedestrian traffic is a concern, engineering judgment should be used to determine if pedestrian signals are needed for crossing or an alternate route should be established.

When a PTTS is located within a work zone, but not in use, the unit should either be covered or removed.

The owner/operator shall operate the PTTS in accordance with the manufacturer's recommendations.

Material Requirements

If the decision is made to use a PTTS on an MTO highway, then the device must adhere to the following criteria:

- The PTTS must meet the physical display and operational criteria of conventional signals as specified in OTM Book 12.
- Be listed on the Ministry's DSM list.
- Be programmable as either a fixed-timed or actuated-timed operation.
- If the system is an actuated time operation unit, then it must utilize one or more of the following detection devices:
 - microwave detection technology;
 - loop detection technology; and/or
 - video detection technology.

General Hardware Requirements

- A mounting height capability of 5.0 m for both primary and secondary signal heads on each trailer measured from the road surface to the bottom of the signal head backboard.

- Both traffic signals heads must be mounted at 5.0 m on all MTO contracts.
- The two signal heads shall be laterally separated at a minimum of 3.0 m.
- All colour lenses must comply with the Institute of Transportation Engineers (ITE) interim/final specifications for incandescent or light emitting diode (LED) lamps for chromaticity and luminous intensity.
- Signal heads must be reversible on the boom to allow trailers to be mounted on the same side of the roadway and protected by barriers.
- Signal supports must consist of sturdy brackets that may be attached to a trailer.

NOTE***Trailer and Controller***

- Each trailer unit must be able to operate either as a master or local.
- Each trailer must be interconnected by either hardwire or radio.
- The controller has circuitry which must detect low voltage and prevent the occurrence of an unsafe signal indication.
- In the event of low voltage, the signal must default to either a flashing or solid all red.
- The controller must provide a red flash cycle that is continuously flashed at a rate of 50-60 times per minute.
- If a radio interconnection is used, then:
 - the system must have a mobile license from Industry Canada (if applicable);
 - the frequency and radio equipment must be approved for use in Canada by Industry Canada; and
 - the approval for the spread spectrum frequency band that is being used must meet Industry Canada requirements.
- **The traffic signal controller must be equipped with a conflict monitor that monitors the following:**
 - master and local absence of display;
 - master and local conflicting display on the same signal head or heads; and
 - master and local conflicting displays on opposing heads.

NOTE

- When a conflict is identified, or radio interference/failure occurs, the controller shall send out a message to the owner/operator via one or more of the following methods:
 - cell phone technology;
 - satellite technology; and/or
 - email or Blackberry technology.
- All conflicts must be recorded in an error log with the exact date and time of the occurrence.
- The error log must be retrievable by the road authority.
- The controller must be password protected or have other security devices in place to prevent program tampering.

Power Supply

- The generator/battery and other electronic controls must be completely inaccessible to unauthorized personnel and protected by a sturdy lockable metal enclosure.
- The unit must be alternatively powered by two or more (primary power and back-up) of the following methods:
 - generator;
 - solar power;
 - electrical power; and/or
 - battery.
- The battery capacity must be sufficient enough to operate the system without recharging for a minimum of 14 days.

Green Clearance Interval Requirements

- The maximum and minimum green time must be user selectable.
- All timing intervals are capable of being set in increments of one second.
- For actuated time operations:
 - Vehicle extension time can be set in the signal controller.
 - If the detectors fail, the system places a constant call to the controller to ensure that it reaches the maximum green time for every cycle.

Yellow Clearance Interval Requirements

- Yellow clearance interval must be user selectable and consistent with OTM Books 7 and 12.

Red Clearance Interval Requirements

- Red clearance interval must be user selectable and consistent with OTM Books 7 and 12.
- The controller must be capable of providing a variable all red clearance interval between 0 - 600 seconds.

5.3.4 Temporary Traffic Signals

Temporary traffic signal installations require the approval of the responsible road authority prior to installation. Adjustments to the signal timing may not be made unless pre approved by the road authority. A legal drawing must be prepared prior to installation and turned on as per HTA 144(31). These installations must comply with all regulations that pertain to traffic signals identified in HTA Regulation 626.

Operational and timing requirements for temporary traffic signals are the same as those for permanent signals. A standard conflict monitor must be used to verify the operation of the Master and Local trailers. The conflict monitor must be capable of monitoring the following: Master and local absence of signal display; Master and local conflicting display on the same signal head; and Master and local conflicting displays on opposing heads. Temporary illumination through the use of a standard design is required for all temporary traffic signal installations. The design standards/specifications for temporary traffic signals are those that apply to permanent traffic signals as identified in OTM Book 12.

Signal Timing Calculations for PTS or Temporary Traffic Signals

[Table 4 Service Volume at Signalized Single Lane Construction Sites \(Vehicles per Hour – One Way\)](#) shows the service volumes at signalized single lane construction sites for a range of single lane lengths. [Table 4 Service Volume at Signalized Single Lane Construction Sites \(Vehicles per Hour – One Way\)](#) can be used to determine the cycle lengths and all-red times required for a PTTS or temporary traffic signal when used to alternate the right of way through a one-lane section of roadway. Refer to OTM Book 12 - Traffic Signals for more detailed information.

NOTE

Temporary traffic signal installations require the approval of the responsible road authority prior to installation.

NOTE

Figure 12 Signal Timing Calculations Example

Given: Heaviest approach volume (one way) = 520 veh/h, Length of single lane section = 150 m

Find: Length of green interval (one direction), Length of all-red interval

Solution: By applying the given figures to Table 4, we find that:

(a) Cycle length = 90 s

(b) All-red interval = 14 s.

The amber clearance from the OTM Book 12 (Traffic Signals) formula calculated using a 1.8 second perception-reaction time is 3.6 seconds at 40 km/h. Round this value up to 4 seconds if the PTTS is unable to provide tenths of a second for the amber interval.

Since the green time for each approach is equal to the cycle length, minus two all-red intervals (28 s), minus two amber intervals (8 s if minimum) divided by two, then the:

$$\text{Green Time (for each approach)} = (90 - (2 \times 14) - (2 \times 4)) / 2 = 27 \text{ s}$$

Not all single lane construction zones will have a speed of 40 km/h. The following describes how the timing of portable traffic signals at signalized single lane construction zones may be calculated for speeds other than 40 km/h.

Given: heaviest approach volume (one-way) = SV, Length of single lane = L

(1) Calculate the all-red interval, AR seconds

$$\begin{aligned} \text{AR(s)} &= \text{Length of Single Lane (m)} / \text{Operating Speed (m/s)} \\ &= 3.6 \times \text{Length of Single Lane (m)} / \text{Operating Speed (km/h)} \end{aligned}$$

(2) Choose a desired cycle length, C seconds (ranging from 40 to 150 seconds)

Figure 12 Signal Timing Calculations Example Continued

- (3) Calculate the average vehicle arrival rate, VAR

$$\text{VAR} = \text{SV} \times \text{C} / 3,600$$

where VAR = average vehicle arrival rate obtained from [Table 5 Vehicle Arrival Rates and Green plus Amber Times \(Level of Service "E"\)](#) which shows the vehicle arrival rates for rural and urban conditions, for LOS "E"

- (4) Calculate green + amber time for each approach, (G + A) seconds, from [Table 5 Vehicle Arrival Rates and Green plus Amber Times \(Level of Service "E"\)](#) for rural or urban conditions.

$$(G + A) \text{ (both approaches)} = \text{C} - \text{AR} - \text{AR}$$

$$(G + A) \text{ (one approach)} = (\text{C} - \text{AR} - \text{AR}) / 2$$

- (5) Green Time (G) = (G + A) – A (seconds)

Example

Heaviest approach volume = 365 veh/h

Length of single lane section = 150 m

Operating speed = 25 km/h

Amber = 3 s

$$(1) \text{AR} = (3.6 \times 150) / 25 = 21.6 \text{ s}$$

- (2) Choose cycle length of 90 seconds

$$(3) \text{VAR} = (365 \times 90) / 3,600 = 9.1 \text{ passenger cars per cycle per lane}$$

- (4) (G + A) from [Table 5 Vehicle Arrival Rates and Green plus Amber Times \(Level of Service "E"\)](#) for rural conditions = 23 seconds

$$(5) \text{Green time (G)} = 23 - 3 = 20 \text{ seconds}$$

Table 4 Service Volume at Signalized Single Lane Construction Sites (Vehicles per Hour – One Way)

| Length of Single Lane (m) | 15 | 30 | 45 | 60 | 75 | 90 | 105 | 120 | 135 | 150 | 165 | 180 | 195 | 210 | 225 | 240 | 255 | 270 | 285 | 300 | 315 | 330 | 345 | 360 | |
|----------------------------------|-----|-----|-----|-----|-----|-----|-----|-----|-----|-----|-----|-----|-----|-----|-----|-----|-----|-----|-----|-----|-----|-----|-----|-----|-----|
| “All Red” Interval One Way (sec) | 2 | 3 | 4 | 6 | 7 | 8 | 10 | 11 | 12 | 14 | 15 | 16 | 18 | 19 | 20 | 22 | 23 | 25 | 26 | 27 | 29 | 30 | 31 | 33 | |
| Cycle Lengths (seconds) | 150 | 810 | 805 | 780 | 755 | 745 | 730 | 710 | 700 | 685 | 660 | 650 | 640 | 615 | 600 | 590 | 565 | 550 | 530 | 520 | 505 | 480 | 470 | 460 | 435 |
| | 140 | 800 | 785 | 770 | 745 | 735 | 720 | 695 | 685 | 670 | 645 | 630 | 620 | 595 | 580 | 565 | 540 | 530 | 505 | 490 | 475 | 450 | 440 | 425 | 405 |
| | 130 | 795 | 775 | 760 | 735 | 720 | 705 | 680 | 665 | 650 | 625 | 610 | 595 | 570 | 555 | 540 | 515 | 500 | 470 | 460 | 445 | 425 | 410 | | |
| | 120 | 785 | 765 | 750 | 720 | 705 | 690 | 660 | 645 | 630 | 600 | 585 | 570 | 540 | 525 | 510 | 490 | 475 | 450 | 430 | | | | | |
| | 110 | 775 | 755 | 735 | 705 | 690 | 670 | 640 | 625 | 610 | 575 | 560 | 550 | 515 | 500 | 485 | 450 | | | | | | | | |
| | 100 | 760 | 740 | 720 | 685 | 665 | 650 | 615 | 605 | 580 | 550 | 530 | 515 | 480 | 460 | | | | | | | | | | |
| | 90 | 745 | 720 | 700 | 680 | 650 | 640 | 600 | 570 | 570 | 520 | 490 | 480 | | | | | | | | | | | | |
| | 85 | 740 | 720 | 700 | 660 | 635 | 615 | 575 | 550 | 530 | 490 | 465 | | | | | | | | | | | | | |
| | 80 | 730 | 700 | 695 | 640 | 630 | 600 | 555 | 540 | 510 | 475 | | | | | | | | | | | | | | |
| | 75 | 725 | 695 | 675 | 625 | 600 | 575 | 530 | 505 | 495 | | | | | | | | | | | | | | | |
| | 70 | 715 | 695 | 670 | 615 | 590 | 565 | 515 | 490 | | | | | | | | | | | | | | | | |
| | 65 | 705 | 665 | 640 | 580 | 570 | 530 | 485 | | | | | | | | | | | | | | | | | |
| | 60 | 695 | 660 | 630 | 570 | 540 | | | | | | | | | | | | | | | | | | | |
| | 55 | 675 | 620 | 620 | 555 | | | | | | | | | | | | | | | | | | | | |
| | 50 | 660 | 615 | 580 | | | | | | | | | | | | | | | | | | | | | |
| | 45 | 640 | 600 | | | | | | | | | | | | | | | | | | | | | | |
| | 40 | 625 | | | | | | | | | | | | | | | | | | | | | | | |

Notes

1. Operating speed of 40 km/h through a work area.
2. Minimum green approximately 15 seconds.
3. Minimum amber of 3 seconds.
4. Based on 50% probability.

Note: Table 4 gives the green and all-red time requirements for a specific speed through a construction zone of 40 km/h. When a PTTS or temporary signal is set up and turned on, a field review is required. The timing should be reviewed and modified, if necessary, as the speed of traffic through a construction zone may vary from that used to calculate the timing.

Table 5 Vehicle Arrival Rates and Green plus Amber Times
(Level of Service "E")

| Vehicle Arrival Rate (VAR) (vehicles/cycle) | Green + Amber (sec) Rural Intersections | Green + Amber (sec) Urban/Commuter Intersections |
|---|---|--|
| 1 | 3.8 | 2.6 |
| 2 | 7.0 | 4.9 |
| 3 | 9.7 | 7.0 |
| 4 | 12.0 | 8.9 |
| 5 | 14.2 | 10.8 |
| 6 | 16.4 | 12.7 |
| 7 | 18.6 | 14.6 |
| 8 | 20.8 | 16.5 |
| 9 | 23.0 | 18.4 |
| 10 | 25.1 | 20.2 |
| 11 | 27.2 | 22.0 |
| 12 | 29.3 | 23.8 |
| 13 | 31.4 | 25.6 |
| 14 | 33.5 | 27.4 |
| 15 | 35.6 | 29.2 |
| 16 | 37.7 | 31.0 |
| 17 | 39.8 | 32.8 |
| 18 | 41.9 | 34.6 |
| 19 | 44.0 | 36.4 |
| 20 | 46.0 | 38.2 |
| 21 | 48.0 | 40.0 |
| 22 | 50.0 | 41.8 |
| 23 | 52.0 | 43.7 |
| 24 | 54.0 | 45.6 |
| 25 | 56.0 | 47.5 |
| 26 | 58.0 | 49.4 |
| 27 | 60.0 | 51.3 |
| 28 | 62.0 | 53.2 |
| 29 | 64.0 | 55.1 |
| 30 | 66.0 | 57.0 |
| 31 | 68.0 | 58.9 |
| 32 | 70.0 | 60.8 |
| 33 | 72.0 | 62.7 |
| 34 | 74.0 | 64.6 |
| 35 | 76.0 | 66.5 |

Note: Each truck or bus is equivalent to 2 passenger cars

NOTE

NOTE

Before work begins, paid duty officers should be provided with information on their roles and responsibilities as well as those of the road authority and workers in the work zone.

5.4 Use of Paid Duty Police Officers

Early and ongoing communication between the road authority, workers, and paid duty police officers is important for the effective planning and coordination of traffic control procedures. Before work begins, paid duty officers should be provided with information on their roles and responsibilities as well as those of the road authority and workers in the work zone. This exchange can be carried out during a pre-construction meeting between the paid duty officer and the road authority. The paid duty officer should be provided with a point of contact in the field and notify the point of contact of any deficiencies, potential problems, or hazardous conditions that s/he had observed.

When deployed in a temporary work zone, paid duty officers should:

- Look over the traffic control plan to identify possible issues that may impede their operation.
- Drive through the work zone from both directions and note all entrance-ways. This will help the officer become familiar with the work zone.
- Maintain visibility by turning on the emergency lights in place of headlights on their vehicles and wearing a retroreflective safety vest while outside of the vehicle.
- Observe traffic conditions at all times while in the work zone.

Paid duty officers will typically perform the following tasks:

Enforcement – the layout of a temporary configuration often presents challenges to effective enforcement. The pre-construction meeting should identify the best approach. A safe location to carry out enforcement should be identified. In a stationary work zone, where practicable, paid duty officers should be located on the shoulder, before the taper begins.

Authority – where enforcement is not practicable, the presence alone of paid duty officers and an enforcement vehicle in the work zone have proven to be an effective measure to help manage speed and increase compliance. The location and schedule should be determined in advance. The effectiveness should be monitored and modified if issues are identified.

Traffic control with moving vehicles – the road authority may specify the use of paid duty officers and police vehicles to be used for pace vehicles, pilot vehicles or to conduct rolling closures. Refer to [Section 5](#) for best practice procedures.

Traffic direction at intersections -TCPs are not to be positioned, or operate, within 30 m of an intersection with active signals. Paid duty police officers must be used to control traffic within an intersection with active signals.

Training of paid duty police officers in the application of OTM Book 7 is recommended to improve their knowledge of traffic control in temporary work zones. Paid duty officers must comply with MOLs requirements to wear appropriate personal protective equipment (PPE).

5.5 Implementation of Buffer Vehicles

A Buffer Vehicle (BV) without a Truck or Trailer Mounted Attenuator (TMA) is defined as a blocker truck. A BV with a TMA is defined as a Crash Truck (CT). A CT is preferred over a blocker truck as the TMA reduces the risk of injury to the occupants of an incoming vehicle and the CT driver.

5.5.1 Buffer Vehicle Required/Recommended Usage

Freeways

The construction regulations prescribed under the OHSA (O. Regulation 213/91) and amended by O. Regulation 145/00, require the use of CTs, to enhance worker safety in many work operations on freeways.

All BVs used on freeways must be CTs. For all SD and LD projects on a freeway that require five days or less to complete, or on freeway projects expected to require more than five days to complete where barriers are not feasible, CTs and an LBA are required for stationary operations, and one or more CTs are required for mobile operations.

CTs are not required on freeways where a lateral offset of 3.0 m or more exists between the work area and live traffic.

CTs are not required for VSD work on freeway shoulders.

NOTE

On multi-lane roads for normal regulatory posted speeds of 70 km/h or higher, a CT is recommended over a blocker truck.

For stationary work areas and mobile work operations, no passengers are allowed in the BV when it is used in traffic control situations.

Non Freeways

BVs are not specifically required on non-freeways under the regulations. If a BV is used on a non-freeway, the appropriate LBA should be used for stationary operations. A CT is always preferred over a BT and multi-lane roads where NPRS is 70 km/h or higher a CT is recommended.

5.5.2 Vehicle/Attenuator Requirements

TMA's, whether truck or trailer mounted, must meet the requirements of NCHRP 350 Level TL-2 (70 km/h) or higher. TMA's should be selected for the appropriate posted speed. TMA's used on freeways must meet the requirements of NCHRP 350 Level 3 (100 km/h).

CTs used on Ministry contracts must have a minimum mass of 6800 kg excluding attachments or ballast (15,000 pounds) and a maximum mass of 12,000 kg (26,400 pounds), including any ballast, flashing arrow boards, or TMA's. Trucks heavier than 12,000 kg may be used if the road authority considers acceleration/deceleration characteristics to be adequate or not an issue. If loose material, such as sand, is used as ballast, it must be kept below the level of the sides of the BV box. If solid objects, such as concrete blocks, are used, they must be attached to the truck body in such a manner as to withstand a major impact without breaking free of its attachments.

BV brakes must be mechanically fit and properly adjusted. A BV with tandem rear axles must have both axles braked when parked in a stationary operation or must be able to raise the unbraked rear axle. Air brakes are preferred over hydraulic brakes on a BV. Users should ensure that at least two-thirds of the BV mass is over the rear axle(s).

BVs used on Ministry contracts must have:

- a mounted 1.2 m x 2.1 m flashing arrow board (TC-12) with in-cab remote controls;
- a high back seat and head rest for the operator;
- a competent, trained operator; and
- an audio alert which automatically activates when backing up.

For both stationary work areas and mobile work operations, no passengers are allowed in the BV when it is used in traffic control situations, except for special reasons.

Where BVs are used to protect stationary work operations, the driver of the BV must ensure that the BV is positioned in accordance with the typical layout figures in this book. The driver ensures that the flashing arrow board is operating, locks the brakes, and angles the wheels slightly away from the work area and live traffic. The driver/operator then leaves the BV for the duration of the work operation.

5.5.3 Placement of Buffer Vehicles

To mitigate risk of injury to road users and workers, two types of out of control vehicular behaviour need to be considered in the placement of BVs: longitudinal and lateral intrusions into a work area.

5.5.3.1 Longitudinal Intrusions

A longitudinal intrusion is when a vehicle enters into a closed lane upstream of a stationary work area through the taper. The length of the lane closure taper plus the LBA upstream of the BV should provide the driver with sufficient braking distance, as illustrated in the diagram in [Figure 13 Buffer Vehicles and LBA Scenarios](#).

Stationary Work Areas

The driver of a vehicle who is entering the lane closure taper longitudinally upstream of the work area will likely begin braking in the taper, after running over the barrels or cones at the start of the taper, and come to a stop within the taper itself. If the driver does not begin braking until the end of the taper, the LBA should provide sufficient additional braking distance for vehicles to come to a halt before the end of the LBA. If the driver has still not come to a complete stop by the end of the LBA, the BV provides a third line of defence for workers.

A BV should not be placed at the end of the taper. If an out of control vehicle does not have sufficient distance to slow down prior to impact, a long BV roll-ahead distance may occur resulting in vehicle damage and personal injury. Provided the LBA is installed upstream of the BV, the expected BV roll-ahead distance is accommodated within the LIDG (see lateral intrusions below). LBA

NOTE

The length of the lane closure taper plus the LBA upstream of the BV should provide the driver with sufficient braking distance.

A BV should not be placed at the end of the taper.

NOTE

and LIDG for various speeds are given in [Table D Application of Longitudinal Buffer Area and Lateral Intrusion Deterrence Gap.](#)

Mobile Work Operations

A stationary LBA cannot be used for mobile work operations. See Section 5.5.3.2 for measures for mobile operations.

5.5.3.2 Lateral Intrusions

The second type of out of control vehicle behaviour occurs when a vehicle, in a live lane adjacent to the work area, laterally intrudes into the gap in the closed lane between the BV and the work area. The appropriate distance to use in front (downstream) of the BV for stationary work operations is called the LIDG. Its use on freeways in combination with the taper, LBA, and BV, is illustrated in the diagram in [Figure 13 Buffer Vehicles and LBA Scenarios.](#)

Stationary Work Areas

To mitigate the risk of lateral intrusions, the BV is positioned about 2.5 seconds in travel time upstream of the workers. It takes the driver of a vehicle about 2.5 seconds to perceive and react to the gap in front of a BV. For example, a vehicle that is travelling at 100 km/h covers 70 m in 2.5 seconds. If a BV is positioned 70 m upstream of the work area, the driver of the vehicle will likely pass by the work area in front of the BV before a decision can be made to turn into the gap. LIDGs for various normal posted regulatory speeds are chosen from [Table D Application of Longitudinal Buffer Area and Lateral Intrusion Deterrence Gap.](#), Stationary Work Operations.

Mobile Work Operations

To mitigate the risk of lateral intrusions into mobile work operations, the BV shadows the work vehicle as it moves along the highway at a distance upstream that is equivalent to about 2.5 seconds in relative travel time between the road user speed and the moving work vehicle.

For example, it takes the driver of an errant vehicle about 2.5 seconds to perceive and react to the gap in front of a moving BV. A vehicle that is travelling at 100 km/h covers 70 m in 2.5 seconds. A BV that is shadowing a moving work operation typically travels at 20 km/h. In 2.5 seconds, the BV would cover 14 m at 20 km/h. If a BV is positioned about 56 m (i.e., 70 m minus 14 m) upstream of the

work area, the driver of the vehicle will likely pass by the moving work vehicle in front of the BV before a decision can be made to turn into the gap.

The appropriate distance to use in front of BVs that are shadowing moving work vehicles is the LIDG. LIDGs for various normal posted regulatory speeds are chosen from [Table D Application of Longitudinal Buffer Area and Lateral Intrusion Determinance Gap](#), Mobile Work Operations.

NOTE

The appropriate distance to use in front of BVs that are shadowing moving work vehicles is the LIDG.

Figure 13 Buffer Vehicles and LBA Scenarios

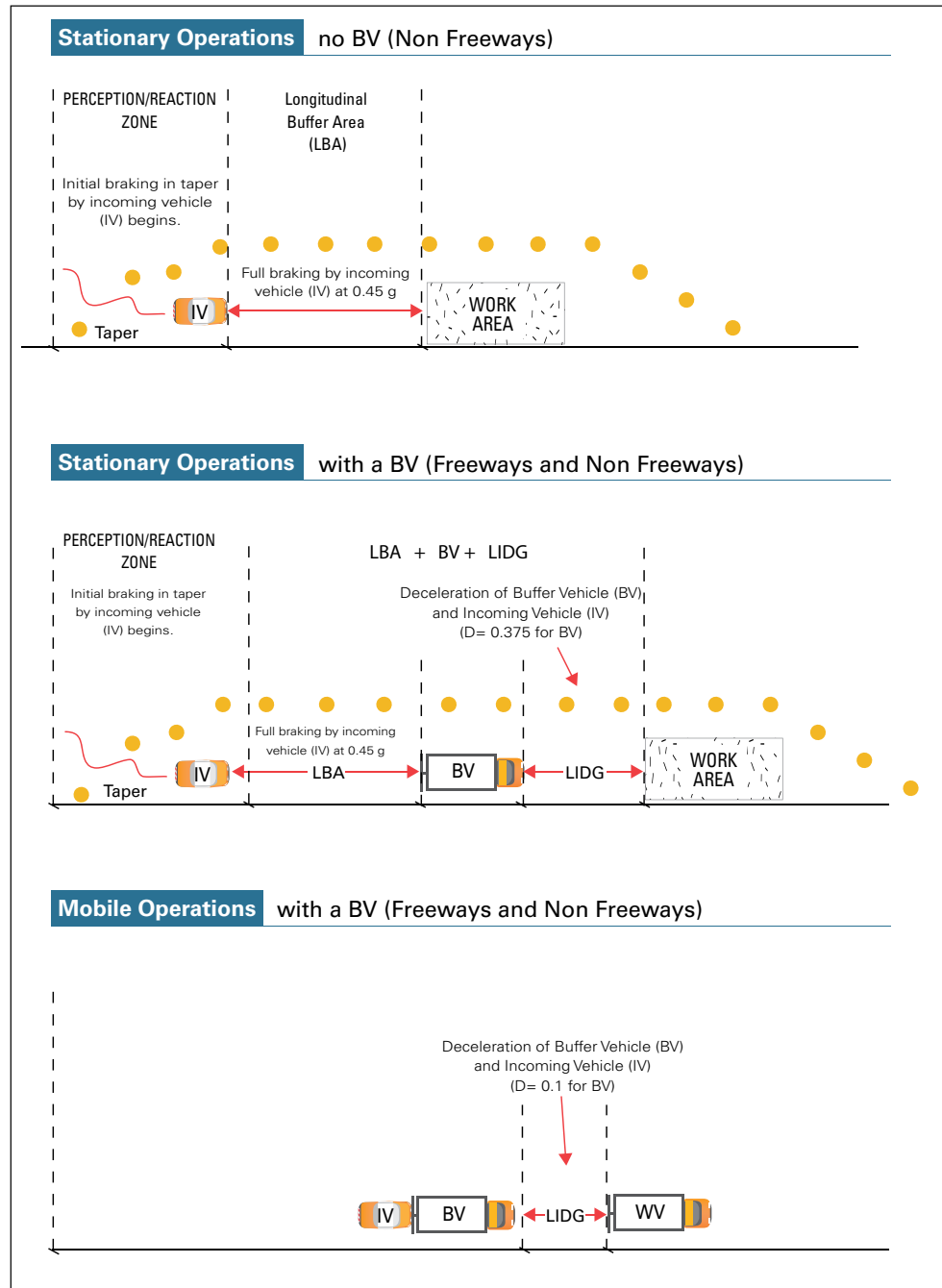

NOTE

It is recognized that zone striping operations on municipal roads do not require the same degree of protection required on multi-lane high speed, provincial freeways.

5.5.4 Requirements for Freeway Zone Painting

A stationary LBA cannot be used for mobile work operations, which increases the risk of an out of control vehicle striking the back of the CT in the longitudinal direction.

To mitigate this risk, contractors and staff who are working for the MTO in zone striping operations on high speed, multi-lane provincial highways must use one CT that is shadowing the zone striper at an LIDG distance (i.e., CT#3 (see [TL-68](#))). Two additional CTs are added upstream of CT#3 (i.e., CT#1 and CT#2). CT#2 shadows CT#3 at a distance of 100 to 300 m. CT#1 shadows CT#2 at a distance of 300 to 600 m. The additional CTs are spaced out depending on roadway geometrics and the time that it takes for the paint to dry. In addition, where shoulder conditions and geometrics will permit, a pre-warning ST with an overhead beacon shadows CT#1 at a distance of 500 to 800 m on the right shoulder with a sign that reads: “Road Painting – Left (or Right) Lane – 2 km”. A pre-warning ST is not required on high traffic volume, urban freeways with physical space limitations (e.g., within the city limits of Toronto or Ottawa).

It is recognized that zone striping operations on municipal roads do not require the same degree of protection required on multi-lane high speed, provincial freeways.

5.5.5 Freeway Paving Operations

The construction regulations under the OHS Act include paving as a mobile operation and require the use of BVs for freeway paving operations. While paving operations progressively move along the road, they do so very slowly, at only a few kilometres each day. In terms of traffic control required, paving operations are more similar to SD or LD stationary operations and treated as such in the typical layouts in OTM Book 7 which fully complies with the traffic control requirements for mobile operations as prescribed in Section 67 (12) of the construction regulations.

Typical layouts that are labelled “Mobile Operations” do not apply to paving operations.

For paving operations on freeways, a reduced regulatory speed limit of 80 km/h (black/white) must be used, enforced by police or pace vehicles, at times when

work is being performed. The reduced speed limit signs must be covered when no work is being performed. PVMS may be placed on one or both sides of the roadway, 500 m in advance of the work zone to warn motorists of the reduced speed (supplementing TL-4). PVMS that advise of a lane closure should be positioned upstream of the expected ends of queues.

To enhance visibility for motorists, the machinery used in paving operations should have conspicuity tape appropriately applied.

5.6 Temporary Concrete Barriers

On long-term freeway construction projects, vehicle penetration into the work areas must be prevented by TCB walls or equivalent (requirement of Regulation 213/91, Section 67, under the OHSA).

They may also be used to positively separate two-way, high-speed/high-volume traffic flows.

The standards described in the U.S. NCHRP Report 350 have been generally accepted as the standards for barriers and TMAs. For temporary barriers, the following standards apply:

- NCHRP TL-2: 70 km/h impact speed;
- NCHRP TL-3: 100 km/h impact speed.

Note: TL-2 and TL-3 referenced by NCHRP are related to TMAs and unrelated to the TL numbers in the typical layout figures in Section 8.

Any sharp change in the alignment of temporary barriers should be delineated by the use of flexible drums (TC-54s).

TCBs used in Ontario must meet the requirements of the OPSS and be placed in accordance with the Ontario Roadside Safety Manual. They are commonly used in section lengths of 2.5 to 4.0 m, connected together to form a continuous barrier. Factors to consider include:

- TCBs can be laterally displaced when struck. Vertical excavation behind a barrier should only occur when the barrier is anchored against lateral displacement, the probability of a high-energy hit is low, or the excavation starts at least 1.0 m from the barrier.

NOTE

Typical layouts that are labelled "Mobile Operations" do not apply to paving operations.

TCBs may also be used to positively separate two-way, high-speed/high-volume traffic flows.

NOTE

- Lane closures are required to place a barrier. It should be constructed in the downstream direction. Barriers that are not placed in accordance with the Ontario Roadside Safety Manual could constitute a hazard.
- An offset distance of at least 0.5 m from the edge of a lane to the barrier is desirable. At a barrier offset of 1.0 m, traffic flow is likely to be unaffected.
- The barrier should be offset in accordance with the OPSS. The leading end of the barrier can then be tapered towards the edge of the lane. This practice should be undertaken regardless of whether energy absorbing end treatments are used. Placement of energy absorbing terminals without an offset will often result in expensive hits to the system that might have been avoided with a greater offset.
- TCBs can impact roadway drainage. Winter sand and other debris can block drainage channels. Construction of 1.0 m gaps spanned by steel beams and channelled to key drainage locations (sumps, catch basins, etc.) should be considered.
- Approved reflective devices are required on TCBs at spacings to be determined by the road authority

Where minimum taper lengths are not practicable within the proper design of the barrier, the required taper must be delineated with flexible drums.

Although barrier walls may serve the additional function of channelizing traffic, their use should be determined by the protective requirements of the location rather than the channelizing needs. The angle of barrier installation is to deflect an errant vehicle, and not to be confused with the taper length and angle specified in Tables A, B, and C in [Section 8](#) that are used for channelization. If a protective barrier also functions as the means for channelization, the devices must be used with temporary pavement edge lines as well as reflective delineation. Taper lengths must comply with the minimum desirable taper length for various approach speeds as provided in Table A, B, or C in [Section 8](#). Where minimum taper lengths are not practicable within the proper design of the barrier, the required taper must be delineated with flexible drums.

6

Specifications for Channelizing, Information, and Guidance Devices

Section 6 provides the specifications for channelizing, information, and guidance traffic control devices and are as required for work on provincial highways and other roadways where MTO is the road authority. This section is to be used once devices have been identified based on the fundamental and guiding principles described in Sections 1 through 4, and/or through a typical layout. See [Section 3](#) for a general description of the devices and typical applications. Refer to [Section 5](#) for best practice procedures and specifications for flow control and positive protection devices. This section is particularly relevant to designers, contractors, and road authorities in preparing or ordering a schedule of devices, any person who is deploying the devices in reference to typical layouts, and supervisors or enforcement officers in evaluating the compliance of devices on site.

NOTE

Section 6 provides the specifications for channelizing, information, and guidance traffic control devices and are required for work on provincial highways and other roadways where MTO is the road authority.

6.1 Cones, Markers, Flexible Drums and Barricades

[Table F Usage of Channelizing Devices, Barricades, and Barriers](#) in [Section 8](#) provides general guidelines for the use of cones, markers, barricades, and barriers.

Traffic Cones

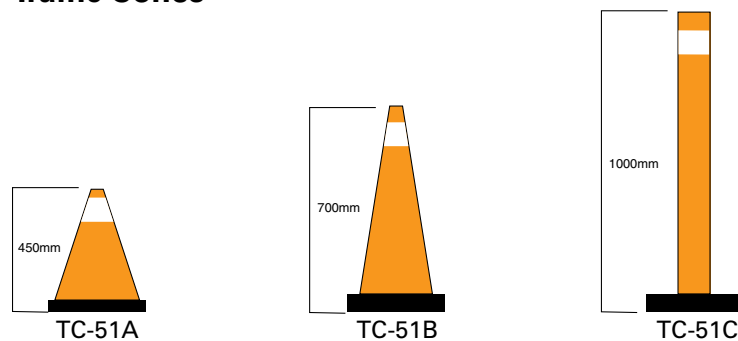

Purpose:

TC-51 traffic cones may be used to delineate diversions and closed lanes, channelize traffic through a construction area, mark channelizing tapers in advance of closed lanes, and generally provide separation between a construction work site and the flow of traffic.

Conditions:

The required spacing of traffic cones is provided in the appropriate table (Table A, B or C: 3*).

All traffic cones must have a reflective white collar.

NOTE

All traffic cones must have a reflective white collar. The white reflective cone collar must be 100 to 150 mm wide, mounted on the upper one-third of the cone taper, 100 mm below the top of the cone or marker (Type III or IV, high intensity reflective sheeting).

Consideration should be given to other channelizing devices for high speed, high volume areas. Reflectorized TC-52s or TC-54s may be used, and in some cases, they must be used as alternatives to cones. See the sections below on these devices.

Cones affected by high winds should be used with ballast or arranged in a configuration using a barricade/cone system. The ballast must not present a hazard if the cone is struck. Suggested means of ballasting include doubling the cones, or the use of heavier weighted cones, special weighted bases, or masses such as sandbag rings or ballast rings made out of recycled tires.

Size: TC-51A (450 mm) may be used for zone painting only.

TC-51B (700 mm) standard

TC-51C (1000 mm) standard

Construction Marker

Purpose:

The TC-52 marker may be used to delineate diversions and closed lanes, channelize traffic through a construction area, mark channelizing tapers in advance of closed lanes, and generally provide separation between a construction work site and the flow of traffic.

Conditions:

The required spacing of construction markers is provided in ^{1200mm} the appropriate table (Table A, B or C: 3*).

Minimum sheeting of reflective horizontal bands is Type III, High Intensity.

Consideration should be given to other channelizing devices (e.g., TC-54) for high speed, high volume areas.

Appropriate bases and uprights (as approved by the road authority) are necessary to ensure the stability of the marker and driver safety in both rural and urban areas.

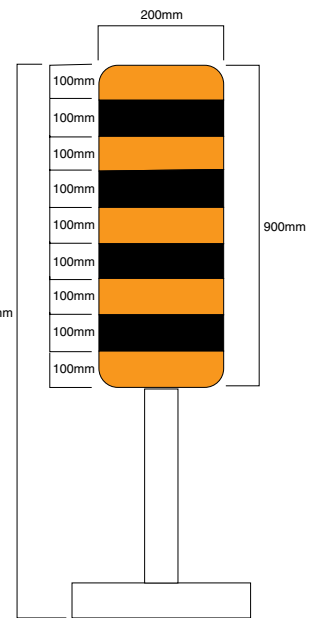

TC-52

TC-52s are typically used with ballast.

Size: 200 mm x 900 mm, top mounted sign
1200 mm above ground level

Flexible Drum (Barrel)

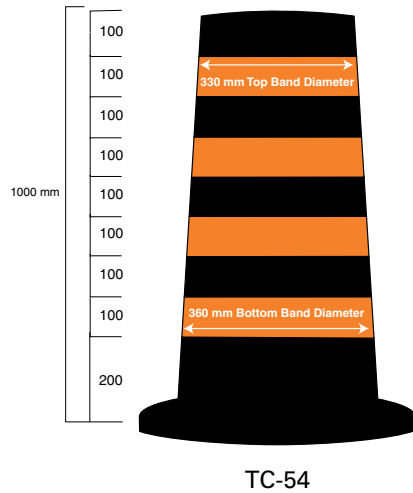

Purpose:

The TC-54 flexible drum (barrel) may be used to delineate diversions and closed lanes, channelize traffic through a construction area, mark channelizing tapers in advance of closed lanes, and generally provide separation between a construction work site and the flow of traffic.

Conditions:

When located near traffic lanes, drums may reduce capacity. Drums should be placed with care to reduce the likelihood of impact. An

offset of 0.3 to 0.6 m between flexible drums (barrels) and the edge of the travelled lane should be maintained.

Where space permits, TC-54s should be used on freeways and other high speed, high volume roads, rather than TC-52s.

The drum must be manufactured to include an anti-roll device in case of impact and should not be constructed in a way that creates a hazard to vehicles. The drum must be ballasted in a manner that does not constitute a hazard to motorists or workers. Suggested means of ballasting include ballast rings of recycled tires or loose sand placed at the bottom (not more than 25 kg). Drums should not be ballasted with rocks, chunks of concrete, or similar objects. Ballast should not be placed on the top of the drums.

Size: 1000 mm height.

Top Reflective Band diameter 330 mm minimum

Bottom Reflective Band diameter 360 mm minimum

The markings of the flexible drums must be horizontal and circumferential, with alternating black and reflectorized orange stripes (four orange bands of High Intensity Type III or higher reflectivity that are approximately 100 mm each).

NOTE

The drum must be manufactured to include an anti-roll device in case of impact and should not be constructed in a way that creates a hazard to vehicles.

NOTE

The TC-53A or TC-53B must not be used as a channelizing device.

Deviations from the standard for pavement markings in OTM Books 7 and 11 are subject to approval from the road authority.

Barricades

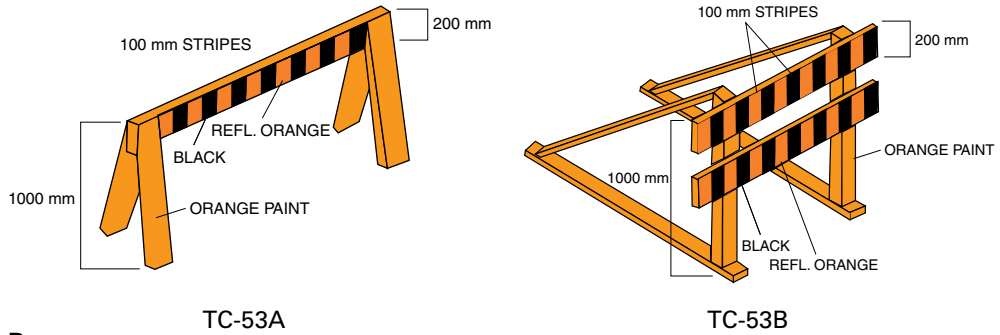

Purpose:

TC-53A or TC-53B barricades must be primarily used to block off road excavation sites or other work site hazards, and prevent vehicular traffic from penetrating into work areas. They may also be used for short-term road closures.

Conditions:

The use of light or heavier barricades depends on the approach speed of traffic and the nature and severity of hazards for which these devices provide protection.

The TC-53A or TC-53B must not be used as a channelizing device.

Size: One or two horizontal cross bars 200 mm x variable length, top edge mounted 1000 mm above ground level.

6.2 Temporary Pavement Markings

Details about the colour, pattern, and retroreflectivity of pavement markings are provided in OTM Book 11 (Markings and Delineation). Temporary pavement markings must comply with the standards prescribed in OTM Books 7 and 11. For more detailed information on temporary roadway marking and delineation techniques, refer to the U.S. Federal Highway Administration (FHWA) Roadway Delineation Practices Handbook. Any deviations from the standard, for economical or other reasons, are subject to approval by the road authority.

Markings must meet the markings in place at both ends of a work zone. Markings should be placed on hard-surfaced detours or temporary roadways before they are opened to traffic. Directional dividing lines should be placed, replaced, or delineated where appropriate before the roadway is opened to traffic.

Colour

Pavement markings are generally white or yellow unless otherwise stated. Where there is little colour contrast between the pavement and the white pavement markings, the contrast may be improved by using black in the gaps of a broken pavement line, using marking tape with white stripes bordered by black on both sides, applying white paint over a double-application black painted line, or using orange temporary pavement markings. Orange pavement markings should only be used for temporary alignment changes on divided multi-lane roadways.

NOTE

Orange pavement markings should only be used for temporary alignment changes on divided multi-lane roadways.

Temporary pavement markers

Where temporary markings are placed in accordance with the principles of colour and pattern described in OTM Book 11, temporary roadway pavement markers may be used as an enhancement. These markers provide reflectivity at night. They may also be used to provide short-term delineation in construction zones prior to the placement of permanent markings. In such short-term uses, temporary roadway pavement markers take the place of short-term markings that are normally applied. Where a line of temporary roadway markers is used as an alternative to temporary markings, the result must be comparable to temporary pavement markings and conform to the principles of colour and pattern that are described in OTM Book 11.

Removal of existing markings

Pavement markings that are no longer applicable or do not define the safe path of travel must be removed, masked, or obliterated as soon as practical, to prevent motorist confusion. Markings are commonly removed by sandblasting, grinding, or chipping. Less commonly, markings can be removed by chemical means, high-pressure water jet, hot compressed-air burning, or excess-oxygen burning. Removal should minimize damage to the road surface or texture. Thermoplastics and permanent tapes are generally more difficult than paints to remove effectively. Temporary tapes are fabricated to be easily removed by hand, and are the preferred solution.

Painting over invalid markings with black paint or bituminous solutions is not a proper removal technique (although it can be a satisfactory solution for the short-term). The covering material wears, so that the invalid markings eventually reappear. Also, markings covered in this way remain visible under some low-light conditions.

NOTE

Raised markers may not be suitable for construction during the winter as they may be affected by snow plows.

Temporary bypasses

When a temporary roadway is constructed to bypass a closed portion of highway, appropriate reflectorized pavement markings must be placed on the approach to, and throughout the length of, the hard surface temporary roadway. At locations where the temporary roadway is relatively short, temporary traffic paint or pressure sensitive marking tape, which can be supplemented by raised pavement markers, may be used to provide short-term expendable pavement markings. It is recognized that raised markers may not be suitable for construction during the winter as they may be affected by snow plows.

Short term pavement markings

Permanent pavement markings must be installed on six-lane freeways before opening to traffic. On other roads, if permanent pavement markings cannot be installed immediately, interim temporary pavement markings must be installed, and the permanent markings must be installed within the following time frame, depending on the road type:

- four-lane freeways – within 15 working days;
- multi-lane non-freeways – within 15 working days; and
- two-lane roads – within 20 working days.

Short term pavement markings in these situations should be a 0.3 m marking with a 15 m gap. If no-passing zones cannot be marked with pavement markings during the interim period, they should be established through the use of signs (Rb-31 and Rb-35).

6.2.1 Orange Temporary Pavement Markings

On MTO highways, the orange pavement markings are to be only used when recommended by the Ministry's Regional Traffic Sections. Fluorescent orange temporary pavement markings can be used on divided multi-lane highways (90 km/h and above prior to construction) where there are changes in alignment to accommodate construction staging. The markings should be applied at the start of the transition, leading up to the new alignment, and continue through the entire length of the construction zone up to where traffic returns to the original alignment.

Fluorescent orange markings can also be used at the discretion of the road authority when there are operational concerns as a result of multiple sets of pavement markings. This may include areas where the speeds are less than 90 km/h or areas where operational problems may be confusing to the driver.

When orange pavement markings are used, all longitudinal lines within a construction zone, including left edge, skip, right edge interchange, and high occupancy vehicle (HOV) markings, shall be orange in colour and markings shall be applied to roadway surfaces and not over existing pavement markings. All existing pavement markings within a construction zone shall be removed by using the methods described in the pavement marking removal guidelines.

Orange temporary pavement markings may be considered for use during winter shut down operations should the existing construction staging and temporary construction signing remain in effect over the winter months.

The type of material used as orange temporary pavement markings must consider the pavement surface, ambient temperature at the time of application, annual average daily traffic, and expected service life duration. Consideration should also be given to the length of the stage(s) and if it is to be placed on asphalt that will not be resurfaced upon the completion of construction.

The actual service life of any marking material will vary, depending on turning movements, traffic volume, and level/type of winter maintenance activities at the specific site.

All orange temporary pavement markings shall be applied in accordance with the manufacturer's recommendations and within the temperature limits recommended by the material manufacturer.

6.2.2 Delineators

All in-service delineators must, as a minimum, employ materials that conform to ASTM D4956-11a or its subsequent revisions for Type III (high intensity) and Type IV (prismatic) materials.

Off-roadway delineators should be installed so that they are within the driver's cone of vision, and positioned at 1.25 to 4.0 m from the edge of roadway and are usually placed 0.6 to 2.4 m beyond the outside edge of a shoulder, or if appropri-

NOTE

The type of material used as orange temporary pavement markings must consider the pavement surface, ambient temperature at the time of application, annual average daily traffic, and expected service life duration.

Delineator conditions must be regularly inspected, and maintenance or replacement of damaged delineators should be implemented as soon as practical.

NOTE

All French translations must be approved by the road authority.

The oversized dimensions are required on roads with a normal regulatory posted speed limit of 90 km/h or higher.

ate, in line with a roadside barrier that is 2.4 m or less beyond the outer edge of a shoulder. Delineators should be placed at a constant distance from the edge of the roadway. Post-mounted delineators (PMDs) or saddle-mounted delineators (SMDs) should be placed on or as close as possible to a temporary barrier, at spacings from 20 to 40 m. Delineator conditions must be regularly inspected, and maintenance or replacement of damaged delineators should be implemented as soon as practical.

6.3 Traffic Control Signs

This section provides a detailed description of the purpose and proper use of each sign typically used in temporary traffic control.

Dimensions, including supports, positioning, and pertinent installation details, are shown in OTM Book 2 (Sign Design, Fabrication and Patterns) and OTM Book 3 (Ground Mounted Sign Support and Installation) for all signs, including all temporary condition signs. General guidelines for size, retroreflectivity, material, and installation are provided below. Where specifications are prescribed in the descriptions for individual signs (in [Section 6.3.5](#) or Typical Layouts), they must be used.

All French translations must be approved by the road authority.

Full scale patterns for the signs indicated herein are available in the OTM Book 2 CD.

6.3.1 Sign Size

The **Standard** dimensions for the signs shown in OTM Book 7 are the sizes recommended for typical work zones in two-lane and multi-lane (up to 4 lanes) roadways with posted speed limits of 80 km/h or lower. Where more than one size is shown for a sign, the largest dimensions (referenced as **Oversized**) are preferred on multi-lane (more than 4 lanes) roadways with a normal regulatory posted speed limit greater than 60 km/h but less than 90 km/h, and required on roads with posted speed limits of 90 km/h or higher. Where dimensions are not prescribed in the descriptions for individual signs (in [Section 6.3.5](#) or Typical Layouts), [Table 6 Minimum Dimensions of Work Zone Warning Signs](#) provides a general guideline of sign sizes to be used for a range of work zone situations.

Table 6 Minimum Dimensions of Work Zone Warning Signs

| Road Type | Normal Posted Regulatory Speed Limit (km/h) | Sign Size | |
|---|---|-----------|---------------------------------------|
| | | Standard | Oversized |
| Two-lane Roads and Multi-lane (up to 4 lanes) | 80 or lower | X | |
| | 90 or higher | | X (preferred where space permits)* |
| Multi-lane Roads ** (more than 4 lanes) | 60 or lower | X | |
| | 70 to 80 | | X (preferred where space permits)* |
| | 90 or higher | | X |
| Freeways ** | All | | X |

* If space does not permit oversize signs, signing is to be repeated on the right side.

**On divided highways, signing is to be repeated on the left if there are more than two lanes in one direction. Supplementary signs may be located on the left side of the roadway where the median is wide enough to safely accommodate the signs, or repeated on the right side if the median is too narrow.

6.3.2 Sign Reflectivity Standards

Regulatory, warning, or guidance (directional) signs need to be legible and conspicuous at night as well as during the day. The colour of the sign must appear to be the same at night as by day. The reflectivity of a sign is important for maintaining a satisfactory level of sign legibility and conspicuity at night. Standard levels for reflectivity are identified as Type I through Type XI and are defined in detail in ASTM D4956-11a, or its subsequent revisions, and in OTM Book 2.

Signs that are the most important to ensure road user and worker safety must have the highest levels of reflectivity. Temporary Conditions signs are grouped into three levels of importance with a corresponding minimum background reflectivity:

- Lowest level signs must have a minimum background reflectivity of Type I (engineering grade).
- Intermediate level signs must have a minimum background reflectivity of Type III (high-intensity).
- The highest level signs must have a minimum background reflectivity of Type VII (high reflectivity micro-prismatic fluorescent).

The reflectivity requirements stated in this book are the minimums. Except for TC-12, higher reflectivity may be used where the road authority considers it nec-

NOTE

Regulatory, warning, or guidance (directional) signs need to be legible and conspicuous at night as well as during the day.

Signs that are the most important to ensure road user and worker safety must have the highest levels of reflectivity.

NOTE

essary; however, the relative importance of the signs in the three-level hierarchy should not be lost in doing so.

The minimum reflectivity requirements for various signs are shown in [Table 7 Minimum Reflectivity Requirements](#). Refer to OTM Book 2 for all reflectivity requirements for Temporary Conditions Signs.

Table 7 Minimum Reflectivity Requirements

| Minimum Reflectivity | Signs/Devices | Importance Hierarchy |
|---|---|--|
| Type VII or greater (min. High reflectivity micro-prismatic fluorescent, Type VII) | TC-1, TC-1A, TC-1B, TC-2A, TC-2B, TC-3, TC-4, TC-9, TC-16, TC-18, TC-21, TC-22 ("Slow" side) double-sided Slow Paddle | Highest (highest reflectivity level) |
| Type III to Type VII (min. High intensity, Type III) | TC-7, TC-12, TC-22 ("Stop" side), Rb-91, Rb-92, TC-51(A, B, C), TC-52, TC-53, TC-54 | Intermediate (intermediate reflectivity level) |
| Type I to Type III (min. Engineering grade, Type I) | All other temporary condition signs | Lowest (lowest reflectivity level) |

6.3.3 Sign Material and Thickness

Typical materials and thicknesses for signs are:

- aluminum with a thickness of 2.0 mm;
- galvanized steel with a thickness of 1.6 mm; and
- plywood with a thickness of:
 - 19 mm is standard for use on MTO highways
 - 12.5 mm, may be used for sign sizes of 1200 mm x 1200 mm, or smaller.

Signs larger than 900 mm x 900 mm should be made of plywood rather than aluminum or steel. Plywood may also be used for smaller signs.

Fibreglass reinforced plastic or other material may be substituted for some aluminum or galvanized steel sign blanks. The use of plastic or other material as sign blank material is subject to approval by a road engineer or superintendent from the road authority. Roll up signs are often made of flexible material to allow ease of transportation while still meeting minimum reflectivity requirements.

The use of plastic or other material as sign blank material is subject to approval by a road engineer or superintendent from the road authority.

[Table 8 Standard Sign Blank Descriptions \(MTO\)](#) lists the blank numbers as assigned by the MTO and the corresponding sign dimensions of more common signs.

NOTE

Table 8 Standard Sign Blank Descriptions (MTO)

| MTO Blank Number | Size (mm) | MTO Blank Number | Size (mm) |
|------------------|--------------------------|------------------|-------------|
| B-8 | 300 x 900 | B-25b | 300 x 600 |
| B-9 | 200 x 900 | B-27 | 900 x 900 |
| B-10 | 450 x 450 trapezoidal | B-29 | 900 x 1200 |
| B-11 | 450 x 450 | B-30 | 1200 x 1200 |
| B-12 | 450 x 750 | B-38a | 900 x 1800 |
| B-13 | 450 x 900 | B-43 | 1200 x 1800 |
| B-15 | 450 x 600 | B-44 | 1200 x 2100 |
| B-17 | 610 x 610 | B-45 | 1200 x 2400 |
| B-18 | 600 x 600 | B-52 | 600 x 750 |
| B-20 | 600 x 900 | B-54 | 900 x 2400 |
| B-23a | 750 x 750 | B-55 | 1500 x 2400 |
| B-25a | 200 x 600 | | |

6.3.4 Positioning and Installation of Signs

A comprehensive treatment of sign installation is found in OTM Books 1b (Sign Design Principles) and 3 (Ground Mounted Sign Support and Installation). The following details the aspects of sign installation in work zones. Typical sign placement is shown in [Figure 14 Typical Sign Placement](#)

Signs should be located where drivers expect to see them, typically on the right side of the roadway and must be in a position where they can be readily seen by road users at all times.

Supplementary (i.e. repeated signs) should also be used on freeways or on multi-lane, one-way roadways, where experience has shown that drivers fail to see the primary signs. See [Table 6 Minimum Dimensions of Work Zone Warning Signs](#). Supplementary signs may be located on the left side of the roadway where the median is wide enough to safely accommodate the signs, or repeated on the right side if the median is too narrow.

Signs must be placed in positions where they will most effectively convey the required message without restricting lateral clearance or sight distance, and at advance distances that allow sufficient response time.

NOTE

Intersections must be identified with standard intersection signs. Route markers must be located along the roadway to ensure route continuity.

Figure 14 Typical Sign Placement

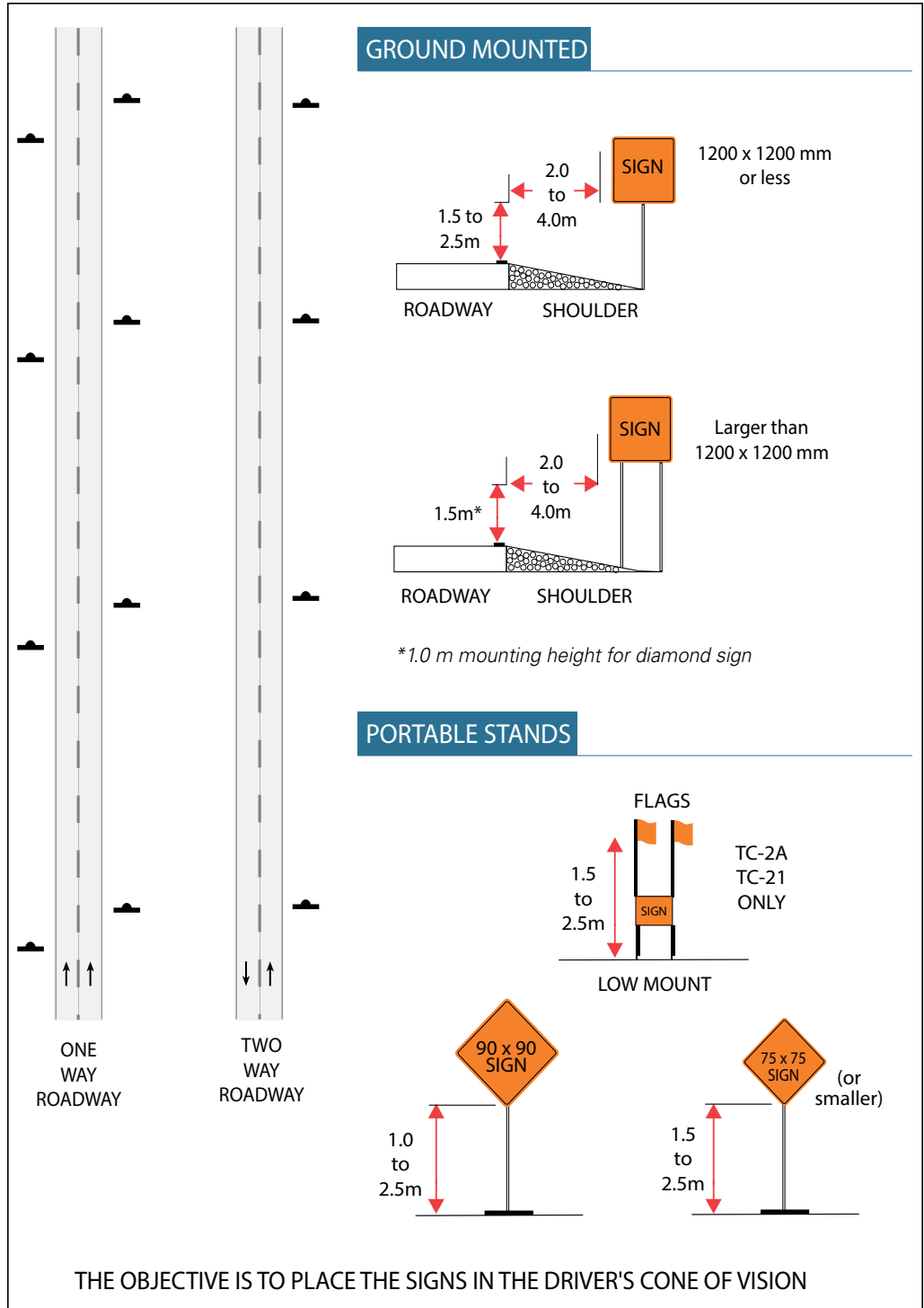

All work zone signs are important. The location and maintenance of all regulatory signs need to be given high priority. **STOP signs in particular must be maintained and visible at all times, and properly located and relocated as necessary through the various stages of construction or maintenance, to ensure that the desired, intended right of way control is in effect at all times.**

All temporary signs must be removed or covered immediately after they are no longer applicable. Permanent standard signs must be in place at the completion of each work project. Signs that pertain to a moving operation (e.g., hot mix paving) must be shifted along the roadway as the operation proceeds.

Signs must be mounted at almost right angles to the direction of travel that they are to serve angled three to five degrees away from the roadway. Adjustments to the height and distance requirements may have to be made to allow placement of signs in constricted urban areas.

Sign supports placed in the clear zone adjacent to a roadway should yield or break away upon impact to minimize hazards to motorists and not present an undue hazard to workers. Signs must not be mounted in or on weighted barrels (e.g., 45 gallon steel drums).

Signs for construction projects on both freeways and non-freeways must either be installed on direct buried posts or mounted on bases with sufficient ballast that they will remain in position for the duration of the project. Fixed supports are preferable for long-term projects. Sign supports or bases should be designed to be safe when impacted. The ballast should not comprise a material and/or size, such as a piece of steel or block of concrete that could be hazardous if struck by a vehicle.

Ground mounted signs

- Signs that are 1200 mm or less in width must be installed on single or double posts with the bottom edge of the sign at a height of 1.5 to 2.5 m above the travelled portion of a roadway.
- Signs that exceed 1200 mm in width must be installed on two posts at a general height of 1.5 m above the travelled portion of a roadway to the bottom edge of the sign, with the exception of the diamond shaped two-post sign which shall have a minimum height of 1.0 m.
- The lateral distance from the edge of a roadway to the nearer edge of the sign must be from 2.0 to 4.0 m on freeways (rural and urban) and roads in rural areas, and 0.3 to 2.0 m on non-freeways in urban areas.

NOTE

All temporary signs must be removed or covered immediately after they are no longer applicable.

NOTE

Low-mounted portable sign stands (e.g., A-frame type) may only be used for TC-2A or TC-21.

Portable stands

- Signs installed are usually positioned on the usable portion of a shoulder. The portable supports for these signs should be constructed in such a manner that they will not be a hazard to errant vehicles, yet sufficient to remain upright.
- Signs that are less than 900 mm in width must be installed at a height of 1.5 to 2.5 m above a roadway.
- Signs that are 900 mm or greater in width must be installed at a height of 1.0 to 2.5 m above a roadway.

Low-mounted portable sign stands (e.g., A-frame type) may only be used for TC-2A or TC-21. Signs mounted on these stands must have flags attached to them to bring the attention of drivers to the message on the sign. The bottom of the flags should be approximately 1.5 to 2.5 m from the ground. The sign bases must be made of a sound material to adequately support the sign; however, the base should not be appreciably wider than the sign. Ballast, if required, will help to prevent the sign from blowing over by the wind. The ballast must not comprise a material and/or size, such as a piece of steel or block of concrete, that could be hazardous if struck by a vehicle.



Roll-up signs may be used, however, the specifications must conform to the sign specifications outlined in the OTM book series (i.e., OTM Book 2 (Sign Design, Fabrication and Patterns) and this section of OTM Book 7) and they must be able to withstand the push/pull from vehicles in the environment they are to be used in (i.e. freeway, non-freeway, high volume of heavy vehicles). Signs may require ballast. Ballast is recommended to be made of water resistant bags filled with small stone weighing no more than 12 kg for ergonomic considerations.

6.3.5 Individual Sign Specifications – Static Message Signs

Where standard or oversize sign sizes are not specifically prescribed for a roadway cross section or type, refer to [Table 6 Minimum Dimensions of Work Zone Warning Signs](#).

Where only one size is given, it may be used for all roadway cross sections or types.

Construction Ahead Signs

| TC-1 | TC-1A | TC-1B |
|--|---|--|
| CONSTRUCTION AHEAD | CONSTRUCTION AHEAD 1 KM | CONSTRUCTION AHEAD 2 km |
|  |  |  |
| Minimum Background Reflectivity: High reflectivity micro-prismatic fluorescent (Type VII) | | |

Purpose:

TC-1, TC-1A and TC-1B signs must be used to provide advance warning of a work zone for long duration operations and may be used for a short duration work zone.

Conditions:

The TC-1 sign must be installed in advance of a work zone at the distance specified in the appropriate table (Table A, B, or C: 5*) or as shown on the TLs.

In urban areas with NPRS of 60 km/h or lower, the TC-1 sign is sufficient. In rural areas, a TC-1A sign must be added at a distance of 1 km in advance of the work zone. For freeways, TC-1A and TC-1B signs must be installed at distances of 1 km and 2 km from the work zone, respectively.

On a divided highway, two TC-1 signs must be installed, one on each side of the approaching lanes.

Additional TC-1 signs must be installed on intersecting roads in advance of the construction site at the distance specified in the appropriate table (Table A, B, or C: 5*). On major intersecting roads, the TC-1 sign must be preceded by a TC-1A sign 1 km in advance of the work zone on the crossing road.

An additional TC-1 sign should be installed on an on-ramp where the acceleration lane ends within 400 m of the beginning of the lane closure taper.



Size:

900 x 900 mm (standard)

1200 mm x 1200 mm (oversized) - must be used on roadways with more than two lanes, and NPRS of 70 km/h or higher. In urban areas, the standard size sign may be used if space does not permit.

1200 mm x 1200 mm (oversized) - must be used on a divided highway, one on each side of the approaching lanes. On a narrow median, the standard size sign may be used if space does not permit the over-sized sign.

Road Work Signs

| TC-2A | TC-2B |
|---|---|
| ROAD WORK (short duration) | ROAD WORK (short & long duration) |
|  |  |
| <p>Minimum Background Reflectivity: High reflectivity micro-prismatic fluorescent (Type VII)</p> | |

Purpose:

The TC-2A or TC-2B sign must be used to inform road users that workers may be present.

Conditions:

The TC-2A or TC-2B sign must be installed as indicated in the typical layouts.

The TC-2A must be mounted on a portable stand with flagpoles and opaque fluorescent orange flags, 450 mm x 450 mm in size, at a height of 1.5 to 2.5 m above the ground.

The TC-2B sign must be installed on single or double posts when maintenance or minor construction activity extends over longer periods of time, and is of a more stationary nature.



ATC-2A or TC-2B sign must also be used at multiple locations within long construction zones whenever and wherever workers are present.

The signs must be located on the shoulder or the curb in full view of approaching traffic. The signs must be installed at a distance from the work area at the distance specified in the appropriate table (Table A, B, or C: 5*). When the TC-21 TRAFFIC CONTROL PERSON AHEAD sign is used, ROAD WORK signs must be located at the same distance as defined above, in advance of the TC-21 sign.

Size:

900 mm x 900 mm

Lane Closed Ahead Signs

| TC-3R | TC-3L |
|--|---|
| RIGHT LANE CLOSED AHEAD | LEFT LANE CLOSED AHEAD |
|  |  |
| <p>Minimum Background Reflectivity: High intensity (Type III), after January 1, 2016 becomes High reflectivity micro-prismatic fluorescent (Type VII)</p> | |

Purpose:

The TC-3R or TC-3L sign must be used to provide advance warning of a closed lane.

Conditions:

The signs must be installed in advance of the TC-4 LANE CLOSURE ARROW sign at the distance specified in the appropriate table (Table A, B, or C: 5*) and as shown in the typical layouts.





Where lane closures involve more than one lane, a TC-3 must be installed in advance of each lane closure. On a divided highway, two TC-3 signs

must be installed, one on each side of the approaching lanes.

Size:

900 mm x 900 mm (standard)

Lane Closed Tab Signs

| TC-3Ct | TC-3Rt | TC-3Lt | TC-3tA |
|---|---|--|---|
| CENTRE LANE CLOSED TAB | RIGHT LANE CLOSED TAB | LEFT LANE CLOSED TAB | 300 m TAB |
|  |  |  |  |
| <p>Minimum Background Reflectivity: High intensity (Type III)</p> | | | |

The TC-3Rt RIGHT LANE CLOSED, TC-3Lt LEFT LANE CLOSED and TC-3Ct CENTRE LANE CLOSED tab signs may be used for “right”, “left”, and “centre” lane closures, respectively, with the appropriate reversal of the sign symbol layout. A supplementary tab sign (TC-3tA) may be used where, due to vertical curvature or other reasons, the start of the lane reduction is not visible in advance for a sufficient distance. The TC-3tA tab sign may be used with other signs and distances where appropriate.



Size:

TC-3_t 600 mm x 600 mm

TC-3tA 300 mm x 600 mm (standard)

450 mm x 900 mm (oversized)

Lane Closure Arrow Signs

| TC-4L | TC-4R |
|--|---|
| LANE CLOSURE ARROW | LANE CLOSURE ARROW |
|  |  |
| Minimum Background Reflectivity: High reflectivity micro-prismatic fluorescent (Type VII) | |

Purpose:

The TC-4L or TC-4R sign must be used to inform road users to merge into an adjacent open lane or on a partial lane shift.

Conditions:

The TC-4 sign must be installed at or just beyond the beginning of a lane closure taper.

The TC-4 sign must not be placed where it will direct vehicles into a lane with opposing traffic flow.

On freeways, the TC-4 sign must be used together with the TC-3 LANE CLOSED AHEAD sign.

May be enhanced with a amber beacon where shown in the typical layouts.

Size:



900 mm x 900 mm (standard)

750 mm x 750 mm - truck-mounted TC-4 may be used for SD work operations where the normal posted speed is 60 km/h or lower.

1200 mm x 1200 mm (oversized) - must be used on roadways with more than two lanes for long duration operations and posted speeds of 70 km/h or higher. In urban areas, the standard size sign may be used if space does not permit the oversized sign.

1200 mm x 1200 mm (oversized) - must be used on freeways.

Detour Ahead Signs

| TC-5 | TC-5A | TC-5B |
|---|---|--|
| DETOUR AHEAD | DETOUR AHEAD 1 km | DETOUR AHEAD 2 km |
|  |  |  |
| Minimum Background Reflectivity: Engineering Grade (Type I) | | |

Purpose:

The TC-5, TC-5A or TC-5B sign must be used to provide advance warning of a detour.

Conditions:

The TC-5, TC-5A and TC-5B signs must be installed where a TC-7 is used to indicate a route detour.

The TC-5, TC-5A and TC-5B signs must also be used where one direction of a divided highway detours across the median and travels in a lane of the opposing direction (where space permits).

Two TC-5, two TC-5A and two TC-5B signs must be installed if the highway is divided, one of each on either side of the approaching lanes.

The TC-5 sign must be installed in advance of the detour information signs (TC-64 to TC-67 and TC-10) at the distance specified in the appropriate table (Table A, B, or C: 5*) and as shown in the typical layouts.

The TC-5A sign is to be positioned 1 km in advance of the detour, and TC-5B is positioned 2 km in advance of the detour.

Size:

900 mm x 900 mm (standard)



1200 mm x 1200 mm (oversized) - must be used on roadways with more than two lanes. In urban areas, the standard size sign may be used if space does not permit the over-sized sign for SD operations in urban work zones where posted speeds are 60 km/h or lower.

1200 mm x 1200 mm (oversized) - must be used on a divided non-freeway, one on each side of the approaching lanes. On a narrow median, the standard size sign may be used if space does not permit the over-sized sign.

1800 mm x 1800 mm (oversized) - must be used on a freeway, one on each side of the approaching lanes.

On a narrow median, the 1200 mm x 1200 mm size sign may be used if space does not permit the over-sized sign.

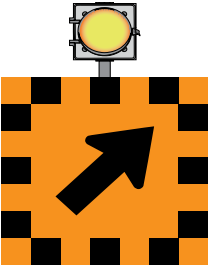
Detour-Turn Off/Diversion Signs

| TC-7 | TC-7tA | TC-7tB |
|---|---|--|
| DETOUR-TURN OFF/DIVERSION | ROAD CLOSED TAB | LOCAL TRAFFIC ONLY TAB |
|  |  |  |
| Minimum Background Reflectivity: High intensity (Type III) | | |

Purpose:

The TC-7 sign must be used to indicate a road closure or route detour, as illustrated on the typical sign layouts.

Conditions:

Due to its large size, the TC-7 sign must be mounted on stands at a height of 1.2 m from the pavement level to the bottom edge of the sign (rather than the normal minimum of 1.5 m).

A amber beacon visible for a minimum distance of 150 m must be used in conjunction with this sign, exposed and continuously kept in flashing operation from sunset until sunrise, except where the flashing light would cause confusion if the sign is used near a signalized intersection.



ATC-7tA tab sign should be used as a separate tab when a roadway is physically closed and an alternative route must be taken. Note: See Sections 28(3) and 102(3) of the Public Transportation and Highway Improvement Act R.S.O.1990, R.R.O. May 1986.

ATC-7tB tab sign should be used as a separate tab when access is permitted to an area beyond the TC-7 DETOURTURN OFF/DIVERSION sign or TC-7tA ROAD CLOSED tab.

Size:

- TC-7 **1200 mm x 1200 mm (standard)** – for urban non-freeways only
- 2100 mm x 2100 mm (oversized)** – must be used on rural non-freeways and freeways
- TC-7tA **250 mm x 1200 mm (standard)** – for urban non-freeways only
- 250 mm x 2100 mm (oversized)** – must be used on rural non-freeways and freeways
- TC-7tB **250 mm x 1200 mm (standard)** – for urban non-freeways only
- 250 mm x 2100 mm (oversized)** – must be used on rural non-freeways and freeways

Roadside Diversion Warning Signs

| TC-9 | TC-9R(2) | TC-9R(3) |
|--|---|--|
| ROADSIDE DIVERSION WARNING | ROADSIDE DIVERSION WARNING | ROADSIDE DIVERSION WARNING |
|  |  |  |
| Minimum Background Reflectivity: High reflectivity micro-prismatic fluorescent (Type VII) | | |

Note: TC-9L(#) mirror image, not shown

Purpose:

The TC-9 must be installed at locations where traffic is diverted around work areas, largely or entirely within the highway right of way. The sign indicates the vehicle path to be followed. For diversions over 1km, use TC-16E (curve sign) at the beginning and end of the diversion to indicate vehicle path.

Conditions:

Where the diversion has more than one lane, a sign with the appropriate number of arrows (one arrow per lane) may be used to indicate to drivers that the roadway lanes are continuous through the diversion. If a sign with more than one arrow is used, the number of arrows on the sign must match the number of lanes on the road.

The sign must be installed in advance of the road diversion at the distance specified in the appropriate table (Table A, B, or C: 5*) and as shown in the typical layouts.

If the highway is divided, two signs must be installed, one on each side of the approaching lanes.

Size:

750 mm x 750 mm one lane (standard)

900 mm x 900 mm two lane (standard)

900 mm x 900 mm one lane (oversized) – must be used on freeways

1200 mm x 1200 mm two lane (oversized) – must be used on freeways

1200 mm x 1200 mm three lane (standard and oversized) – must be used on freeways

Detour Designation Signs

| TC-10 | TC-10t | TC-10FR | TC-10AR |
|--------|---------|---------|---------|
| | | | |
| TC-10C | TC-10ER | TC-10BR | TC-10D |
| | | | |

Minimum Background Reflectivity: Engineering Grade (Type I)

Note: for roundabout detour arrows see TL-42(i)

Purpose:

The TC-10 DETOUR DESIGNATION sign, TC-10 marker, and TC-10 A, B, C, D, E, and F markers must be used to indicate an alternate route for traffic to follow where construction activities require total or partial closure of roads or streets, and signed detour routes are required to handle traffic.

Conditions:

The TC-10 DETOUR DESIGNATION sign must be used as a tab with a TC-66 or TC-67 sign in order to provide motorists with advance warning of the detour and inform them of the signs that they are required to follow. The detour route will be given a “Detour Route Number” to clearly indicate the route that motorists are required to follow. This will also minimize confusion for other motorists who are not following the detour route.

Size:

TC-10 600 mm x 1200 mm - urban minimum, non-freeways

1200 mm x 2100 mm freeways

TC-10 (t,A,B,C,D,E,F) 450 mm x 450 mm trapezoid (standard)

600 mm x 600 mm trapezoid (oversized) – must be used on freeways

(900 mm x 900 mm option on freeways)

300 mm x 450 mm arrow (standard)

450 mm x 600 mm arrow (oversized) – must be used on freeways

(600 mm x 900 mm option on freeways)

Narrow Lanes Sign

| |
|---|
| TC-11 |
| NARROW LANES |
|  |
| Minimum Background Reflectivity: Engineering Grade (Type I) |

Purpose:

The TC-11 NARROW LANES sign should be used to warn drivers on multi-lane roads that they are approaching a work area where lane widths have been reduced due to work operations.



Conditions:

In addition to the sign, old pavement markings should be removed or covered, and temporary solid edge lines and lane lines should be provided.

Size:

900 mm x 900 mm

Trucks Use Centre Lane Tab Signs

| | |
|---|---|
| TC-11t | TC-11tA |
| TRUCKS USE CENTRE LANE TAB | FOR XX KM TAB |
|  |  |
| Minimum Background Reflectivity: Engineering Grade (Type I) | |

Purpose:

The TC-11t TRUCKS USE CENTRE LANE tab sign should be used to advise truck drivers on which lane they should use (e.g., centre, right, or left), where lanes have been narrowed and the designated lane is the widest or preferred lane for trucks to use.

Conditions:

The supplementary TC-11tA FOR XX KM tab sign may be used to advise drivers of the length of road for which the narrow lane condition exists.

The TC-11tA tab sign may be used with other signs where it is considered desirable to advise drivers of the length of a given work zone or condition.

Size:

TC-11t 450 mm x 750 mm

TC-11tA 300 mm x 600 mm (standard)

450 mm x 900 mm (oversized) – must be used on freeways

Pavement Ends Sign

| |
|--|
| TC-13 |
| PAVEMENT ENDS |
| |
| Minimum Background Reflectivity: Engineering Grade (Type I) |

Purpose:

The TC-13 sign must be installed in advance of the point where the pavement ends and changes to a gravel surface due to roadwork.

Conditions:

The sign must be installed in advance of the pavement end point at the distance specified in the appropriate table (Table A, B, or C: 5*) and as shown in the typical layouts.

The TC-13 sign is to be used only if the gravel surface extends for more than 10 m. For distances less than 10 m, a TC-15 BUMP sign should be used.

Size:

900 mm x 900 mm

Bump Ahead Signs

| | |
|--|--------------|
| TC-14 | TC-15 |
| BUMP AHEAD | BUMP |
| | |
| Minimum Background Reflectivity: Engineering Grade (Type I) | |

Purpose:

The TC-15 sign must be used to give warning of a sharp change in the profile of the road that is sufficiently abrupt to create a hazardous discomfort to passengers, cause a shifting of cargo, or deflect a vehicle from its intended course when the bump is crossed at the posted speed limit. The TC-14 sign must be used as an advance warning sign that precedes the TC-15 BUMP sign.







Conditions:

The TC-15 sign must be installed adjacent to the bump and removed as soon as the roadway deficiency no longer exists. The TC-14 sign must be located in advance of the TC-15 sign, at a distance taken from the appropriate table (Table A, B, or C: 5*). It must be removed as soon as the roadway deficiency no longer exists. The TC-14 sign may not be required in low speed urban areas.

Size:

600 mm x 600 mm

Turn and Curve Signs

| TC-16AL | TC-16BL | TC-16CL | TC-16DL |
|--|---|---|---|
| TURN | SHARP CURVE | CURVE | SHARP REVERSE CURVE |
|  |  |  |  |
| TC-16E | TC-16EL(2) | TC-16EL(3) | |
| REVERSE CURVE (one arrow) | REVERSE CURVE (two arrows) | REVERSE CURVE (three arrows) | |
|  |  |  | |
| <p>Minimum Background Reflectivity: Engineering grade (Type I) except TC-16E series High reflectivity micro-prismatic fluorescent (Type VII), after January 1, 2016 all become High reflectivity micro-prismatic fluorescent (Type VII)</p> | | | |

Purpose:

Note: TC-16_R(#) mirror image, not shown

The TC-16 turn and curve warning signs are required in construction areas to indicate a sharp curve or turn in the vehicle path to be followed due to physical curvature of the roadway.

Conditions:

Any existing warning signs (yellow background) do not need to be replaced by the orange signs. The TC-16E REVERSE CURVE sign must be used where two curves in opposite directions are separated by a tangent of less than 120 m. ATC-16ER RIGHT REVERSE CURVE sign must be used if the first curve is to the right. ATC-16EL LEFT REVERSE CURVE sign must be used if the first curve is to the left.

Size:

- One Lane** 600 mm x 600 mm (standard)
 750 mm x 750 mm (oversized) - see Note
- Two Lanes** 750 mm x 750 mm (standard)
 900 mm x 900 mm (oversized) - see Note
- Three Lanes** 900 mm x 900 mm (standard)
 1200 mm x 1200 mm (oversized) - see Note

NOTE: In general the oversized curve warning signs must be used in rural areas, and on all road sections where higher operating speeds (70 km/h) can be safely maintained. Where there are severe space restrictions in urban areas, and low observed vehicle speed conditions prevail, the smaller curve warning signs may be used. The oversized sign must be used on Freeways.

Advisory Speed Tab Sign

| |
|---|
| TC-17t |
| ADVISORY SPEED TAB |
|  |
| Minimum Background Reflectivity: Engineering Grade (Type I) |

Purpose:

The TC-17t sign should be used to indicate an advised speed limit reduction.

Conditions:

The TC-17t sign should only be displayed where the safe speed has been determined by the use of a ball bank indicator (or equivalent method) in accordance with the procedure outlined in Section 2, OTM Book 6 (Warning Signs). If necessary, the TC-17t sign can be mounted below the primary signs TC-9 and TC-16A to 16E.

Size:

450 mm x 450 mm

Chevron Alignment Sign

| |
|--|
| TC-18 |
| CHEVRON ALIGNMENT |
|  |
| Minimum Background Reflectivity: High reflectivity micro-prismatic fluorescent (Type VII) |

Purpose:

CHEVRON ALIGNMENT signs may be used to provide additional guidance where there are changes in the horizontal alignment in the roadway. See also OTM Books 6 (Warning Signs) and 11 (Markings and Delineation).

Conditions:

The CHEVRON ALIGNMENT signs may only be installed on the outside of a curve or sharp turn. The sign should only be installed where such a warning is essential.

TC-18s must normally be located at right angles to oncoming traffic, but not in a way that it is misread by opposing traffic. As sight conditions will vary, the spacing of the CHEVRON ALIGNMENT signs should be determined by a field investigation.

All signs used at a location must be the same size, and spacing of the signs should be such that the motorist always has two signs in view until the change in alignment eliminates the need for the signs. Where used, there must be a minimum of four CHEVRON ALIGNMENT signs.



The signs should be installed at a height of 1.2 to 1.5 m above the edge of the nearest traffic lane to the bottom of the sign. Otherwise, they are to be installed in accordance with the general spacing requirement of Table 7 in OTM Book 6, or Table 5 in OTM Book 11.

Size:

450 mm x 600 mm (standard)

600 mm x 750 mm (oversized) - must be used on freeways

Grooved Pavement Signs

| TC-19 | TC-19t |
|---|---|
| GROOVED PAVEMENT | GROOVED PAVEMENT TAB |
|  |  |
| Minimum Background Reflectivity: Engineering Grade (Type I) | |

Purpose:

The TC-19 GROOVED PAVEMENT sign may be used to provide warning to road users, including motorcyclists, where the pavement has been milled or grooved.

Conditions:

The TC-19 sign must be installed in advance of the point where the grooved or milled pavement begins.

The sign must be installed in advance of the smooth pavement endpoint at the distance specified in the appropriate table (Table A, B, or C: 5*).



The supplementary TC-19t GROOVED PAVEMENT tab sign may be used with the TC-19 sign for an educational period.

Size:

TC-19 900 mm x 900 mm

TC-19t 450 mm x 750 mm

Prepare to Stop Signs

| TC-20 | TC-20A | TC-20At |
|---|---|--|
| PREPARE TO STOP | PREPARE TO STOP (with amber flashers) | WHEN FLASHING TAB |
|  |  |  |
| Minimum Background Reflectivity: Engineering Grade (Type I) | | |

Purpose:

The TC-20 (or TC-20A sign with TC-20At) PREPARE TO STOP sign may be used where there is a high probability or certainty that motorists will have to stop for work operations or recurring congestion which results in stop and go traffic.

Conditions:

The PREPARE TO STOP sign should be placed in advance of the expected stopping location at a distance specified in the appropriate table (Table A, B, or C: 5*).

This sign must be covered or removed in periods when there is not a high expectation or certainty of having to stop. The TC-20A PREPARE TO STOP sign with two amber flashers, one on each side of the sign, alternating in a “side to side” manner, must be used together with the TC-20At tab sign. TC-20A with TC-20At may be used instead of the TC-20 sign:

- at work operations necessitating periodic traffic stops that can be signalled to motorists, and where the visibility of the operation and/or the need to stop is otherwise poor, and
- at work operations where motorist visibility of congested end-of-queue conditions is poor, and the sign can be activated by a presence detector at such locations.
- The amber flashers used with the TC-20A sign must not continuously flash, and only when triggered by an event or situation that will require a stop.

Size:

TC-20, TC-20A 750 mm x 750 mm (standard)
 900 mm x 900 mm (oversized) - must be used on freeways

TC-20At 450 mm x 750 mm (standard)
 600 mm x 900 mm (oversized) - must be used on freeways

Traffic Control Person (TCP) Ahead Sign

| |
|---|
| TC-21 |
| TRAFFIC CONTROL PERSON (TCP) AHEAD |
|  |
| <p>Minimum Background Reflectivity: High reflectivity micro-prismatic fluorescent (Type VII)</p> |

Purpose:

The TC-21 sign must be used to alert road users to the presence of TCPs

Conditions:

The TC-21 sign must be used at all times when a TCP is on duty and must be taken down when the TCP is not on duty. The sign must be placed in advance of the TCP at a distance specified in the appropriate table (Table A, B, or C: 5*)

The sign must be mounted on a portable stand with flagpoles and opaque fluorescent orange flags, 450 mm x 450 mm in size, mounted at a height of 1.5 to 2.5 m above the ground.

Size:

900 mm x 900 mm

Traffic Control Sign (Stop/Slow Paddle)

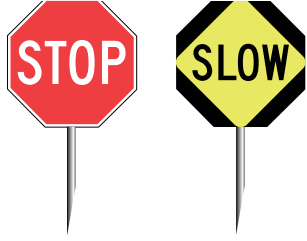
| |
|--|
| TC-22 |
| TRAFFIC CONTROL (STOP/SLOW Paddle) |
|  |
| Minimum Background Reflectivity: Slow: high reflectivity micro-prismatic fluorescent, (Type VII) Stop: High Intensity (Type III) |

Purpose:

The double-sided hand-held traffic TC-22 sign must be used by TCPs to direct traffic.

Conditions:

The TCP will signal the desired warning towards oncoming vehicles in accordance with the instructions detailed in [Section 4](#), and the training given by the road authority or the contractor.

If only one TCP is being used, the side of the sign that is not facing the intended direction of control must be covered in order not to confuse drivers in the opposing direction. The stop side of

the paddle may be enhanced with either one or two red lights that are vertically installed and centred above and/or below the STOP legend as an option to the standard TC-22. The alternating flashing red light(s) are to be briefly activated by the TCP as vehicles approach to enhance conspicuity.

The TC-22 sign and its pole must meet the requirements of Ontario Regulation 213/01, Section 68 under the OHSA.

Size:

450 mm x 450 mm Octagonal shape

Signals Ahead Sign

| |
|---|
| TC-23 |
| SIGNALS AHEAD |
|  |
| Minimum Background Reflectivity: Engineering Grade (Type I) |

Purpose:

The TC-23 sign must be used to provide advance warning of temporary signal systems.

Conditions:



The TC-23 sign must be used whenever lane control signals, portable temporary traffic signals, or temporary traffic signals are in use. This sign is to be installed in advance of the signal system at a distance specified in the appropriate table (Table A or B: 5*). The sign must be removed or covered when the signal system is not in operation.

Size:

600 mm x 600 mm (standard)

750 mm x 750 mm (oversized)

Remote Control Device Ahead Signs

| TC-23A | Tc-23At |
|---|---|
| REMOTE CONTROL DEVICE AHEAD | PREPARE TO STOP TAB |
|  |  |
| Minimum Background Reflectivity: Engineering Grade (Type I) | |

Purpose:

The TC-23A sign must be used to provide advance warning of an automated flagger assistance device (AFAD).

Conditions:

The TC-23A sign must be used as an advance warning sign when an AFAD is being used.

The sign is to be installed in advance of the AFAD at a distance specified in the appropriate table (Table A or B: 5*).

The sign must be removed or covered when the AFAD is not in operation.

The TC-23At PREPARE TO STOP tab sign must be used with the TC-23A sign.

Size:

TC23A 600 mm x 600 mm (standard)
750 mm x 750 mm (oversized)

TC23At 450 mm x 750 mm

Uneven Lanes Sign

| TC-24 |
|---|
| UNEVEN LANES |
|  |
| Minimum Background Reflectivity: Engineering Grade (Type I) |

Purpose:

The TC-24 UNEVEN LANES sign should be used during work operations which create a difference in elevation between adjacent lanes that is large enough to create a hazard for motorists.

Conditions:

The TC-24 sign must be installed in advance of the point where the uneven pavement begins at the distance specified in the appropriate table (Table A, B, or C: 5*).

Size:

750 mm x 750 mm (standard)
900 mm x 900 mm (oversized) - must be used on freeways

Do Not Pass When Flashing Sign

| |
|---|
| TC-27 |
| DO NOT PASS WHEN FLASHING |
|  |
| Minimum Background Reflectivity: Engineering Grade (Type I) |

Purpose:

The DO NOT PASS WHEN FLASHING sign must be used where a pilot vehicle is used to guide traffic through a single lane work zone on a two-lane highway, or where one or more pace vehicles is used to control the speed of traffic through a work zone or implement a rolling closure.

Conditions:

The sign must be mounted on the rear of the pilot vehicle or pace vehicle(s), in plain view of the following vehicles.



See [Section 5](#) on the use of pilot vehicles, pace vehicles, and rolling closures.

This sign is not required on police vehicles that are acting as pilot or pace vehicles.

Size:

750 mm x 1500 mm

Truck Entrance Signs

| TC-31L | TC-31A | TC-20At |
|---|---|--|
| TRUCK ENTRANCE | TRUCK ENTRANCE (with amber flashers) | WHEN FLASHING TAB |
|  |  |  |
| Minimum Background Reflectivity: Engineering Grade (Type I) | | |

Purpose:

The TRUCK ENTRANCE signs must be used when trucks are using an entrance from a work zone into a live lane (turn or crossing movement). The signs may also be used when the temporary condition limits the vision of an existing crossing that is heavily used by trucks (see OTM Book 6 – Warning Signs for sight distance criteria).

The TC-31 sign must be installed in advance of the crossing at the distance specified in the appropriate table (Table A, B, or C: 5*).

The truck entrance sign illustrates the truck entering the roadway, not the work area. If the truck entrance is on the left, the TC-31L sign that is shown above must be used. The TC-31R sign which has the reverse symbol must be used when the truck entrance is on the right.



Where the presence of a truck that is about to enter the road is automatically detected, the TC-31A sign may be used, with two amber flashers, one on each side of the sign, alternating in a “side to side” manner, activated by the detector, so that the amber flashers provide a positive signal to motorists that a truck is about to enter the road. When the TC-31A sign is used, the TC-20At WHEN FLASHING tab sign must also be used. The flashers should not be continuously flashing; otherwise, they will lose their effectiveness. Care must be also taken to ensure that the detector system that is activating the flashers is intact and properly functioning.

Size:

TC-31, TC-31A 900 mm x 900 mm

TC-20At 600 mm x 900 mm

Temporary Bridge Signs

| TC-32 | TC-32t |
|---|---|
| TEMPORARY BRIDGE | TEMPORARY BRIDGE XXX KM/H TAB |
|  |  |
| Minimum Background Reflectivity: Engineering Grade (Type I) | |

Purpose:

The TC-32 sign must be used to warn of a temporary (usually a bailey) bridge ahead, on which the traffic speed is severely reduced, normally to approximately 30 km/h.

Conditions:

The TC-32 sign should be installed approximately 150 m in advance of the bridge.

The TC-32t TEMPORARY BRIDGE XX KM/H tab sign is not mandatory, but may be used



for optional messages about the bridge, advisory speed rates, or both, if deemed necessary for the safety of motorists.

Size:

TC-32 900 mm x 900 mm

TC-32t 600 mm x 900 mm

Low Bridge Ahead Signs

| TC-33 | TC-33A | TC-33B |
|--|---|--|
| LOW BRIDGE AHEAD | LOW CLEARANCE AHEAD XX m | LOW CLEARANCE XX m |
| <div style="border: 1px solid black; padding: 5px; width: fit-content;"> LOW BRIDGE AHEAD TRUCKS OVER XX m USE NEXT EXIT </div> |  |  |
| Minimum Background Reflectivity: Engineering Grade (Type I) | | |

Purpose:

The TC-33 sign is used to warn of a low bridge ahead to provide trucks with the opportunity to exit the highway.

Conditions:

The TC-33 sign must be installed approximately 400 m in advance of the last exit that trucks can use to avoid low clearance in a construction area. This sign must only be used where the clearance of the structure is less than 4.5 m. As work progresses, clearance may change frequently and trucks may not be confined to the normal travelled portion. Immediately after any action which modifies the clearance of the structure, the revised clearance should be accurately measured and the clearance figures reported without any delay to the road authority to determine the need for clearance signing.

As an alternative to the TC-33 sign, where space is limited and frequent opportunities exist to bypass a low bridge (e.g., urban areas), the TC-33A and TC-33B LOW CLEARANCE signs may be used. The black and orange TC-33A and TC-33B signs should only be used where low clearance is a result of work zone activities. If the low clearance is a permanent or semi-permanent condition, the black and yellow Wa-26 and Wa-27 signs should be used instead.

The advance sign, TC-33A, is located in advance of a low clearance. The TC-33B sign is installed, if possible, on the structure just above the opening and over the centre of a roadway, unless the clearance varies over the width of the structure; in which case, a second sign is installed to indicate the lesser clearance. Whenever possible, advance warning of the low clearance condition should be located to permit overheight vehicles to select an alternate route. Additional advance signing with a TC-3tA distance tab sign may be used for this purpose.

Size:

TC-33 900 mm x 2400 mm

TC-33A 600 mm x 600 mm standard

900 mm x 900 mm oversized - must be used on freeways

TC-33B 600 mm x 900 mm

Two-Way Traffic Sign

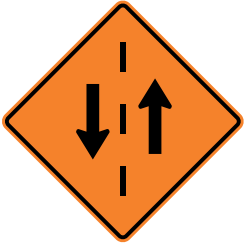
| |
|---|
| TC-34 |
| TWO-WAY TRAFFIC |
|  |
| Minimum Background Reflectivity: Engineering Grade (Type I) |

Purpose:

The TC-34 sign must be used to warn motorists who are driving on a one-way street or highway that they are approaching a road section where a two-way traffic flow is temporarily in operation because of construction. This situation will mainly occur where opposing traffic has been directed across the median of a multi-lane highway due to construction on the other side.

Conditions:

The TC-34 sign must be installed in advance of the two-way traffic area at a distance specified in the appropriate table (Table A, B, or C: 5*) . The beginning of the two-way traffic flow, and additional reminder signs as appropriate, must be marked by regulatory Rb-24 signs.

Size:

900 mm x 900 mm

Ramp Closed Ahead Sign

| |
|---|
| TC-35 |
| RAMP CLOSED AHEAD |
|  |
| Minimum Background Reflectivity: Engineering Grade (Type I) |

Purpose:

The TC-35 sign is used to warn motorists who are driving on a multi-lane street or highway that they are approaching an exit ramp which is temporarily closed because of construction, maintenance, or other activity.

Conditions:

The TC-35 sign must be used for SD operations, and may be used to supplement Long Duration signs, such as the TC-64A or TC-64B.

The TC-35 sign must be installed in advance of the exit taper/deceleration lane (if present), or channelization, at a distance specified in the appropriate table (Table A, B, or C :5*).

Size:

900 mm x 900 mm

Maximum Speed Advisory Sign

| |
|---|
| TC-36 |
| MAXIMUM SPEED ADVISORY |
|  |
| Minimum Background Reflectivity: Engineering Grade (Type I) |

Purpose:

The TC-36 sign is to be used in place of the Rb-1 and Rb-7t MAXIMUM SPEED signs where it is not practical to impose a regulatory speed limit, but a reduced speed limit is deemed necessary.

Conditions:

The TC-36 sign should be used where the geometrics of the roadway are not reduced due to construction, but public traffic is required to mingle with heavy grading or similar operations and it is considered that a combination of advisory speed signing and proper procedures by TCPs should be adequate provisions for the safe passage of traffic.

The signs should be installed approximately 600 m apart for advisory speed zones up to 2 km long, and approximately 1.5 km apart for advisory speed zones of longer distances (the placement of regulatory speed limit signs must comply with longitudinal spacing requirements as stipulated by the HTA).

Size:

600 mm x 900 mm

Soft Shoulders Sign

| |
|---|
| TC-37 |
| SOFT SHOULDERS |
|  |
| Minimum Background Reflectivity: Engineering Grade (Type I) |

Purpose:

The TC-37 sign must be used in work zones where soft shoulders present a hazard to vehicles that may get off the pavement.

Conditions:

The signs must be installed at regular intervals that are approximately 300 m apart over a 1 km stretch and 900 m apart on longer sections.

The signs must be removed after the shoulders have become thoroughly compacted, or are safe for low-speed traversal.

Size:

600 mm x 600 mm

No Exit Sign

| |
|---|
| TC-39 |
| NO EXIT |
|  |
| Minimum Background Reflectivity: Engineering Grade (Type I) |

Purpose:

The TC-39 sign must be used to warn motorists at the entrance to a side road or side street that, due to maintenance, construction, or other work activity, the highway or the street temporarily has no outlet.



Conditions:

The TC-39 sign must be conspicuously posted on both sides of the entrance to the side road, either individually on separate posts or mounted on the barricade that is blocking the entrance.

Size:

450 mm x 450 mm

Pedestrian Direction Sign

| | |
|---|---|
| TC-40 | TC-41t |
| PEDESTRIAN DIRECTION SIGN | SIDEWALK CLOSED TAB |
|  |  |
| Minimum Background Reflectivity: Engineering Grade (Type I) | |

Purpose:

The TC-40 sign is used to indicate to pedestrians the intended pathway through or around a construction, maintenance, or other work area. The sign should be used where the pedestrian is likely to be uncertain as to the intended pathway.

Conditions:

The TC-40 sign must be placed at locations that clearly mark the alternate pathway at all pedestrian decision points.

Size:

TC-40 450 mm x 450 mm

TC-40t 300 mm x 450 mm

Lane Designation Direction Sign

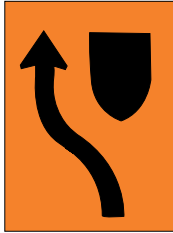
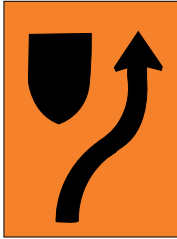
| TC-25L | TC-25R |
|---|---|
| LANE DESIGNATION DIRECTION | LANE DESIGNATION DIRECTION |
|  |  |
| <p>Minimum Background Reflectivity: High reflectivity micro-prismatic fluorescent (Type VII)</p> | |

Purpose:

The TC-25L or TC-25R LANE DESIGNATION DIRECTION Sign should be used to indicate an alternate route for traffic to follow in a Roundabout. The sign indicates the vehicle path to be followed for a specified lane designation.

Conditions:

The TC-25L or TC-25R sign must be used with the corresponding Lane Designation Sign (RB-41 thru RB-47), as shown in the Typical Layouts.

The TC-25L or TC-25R must only be used at Roundabouts. For diversions around an obstruction for all other cases use RB-25 Keep Right (see OTM Book 5 – Regulatory Signs).

Size:

600 mm x 900 mm

Speed Fines Doubled Sign

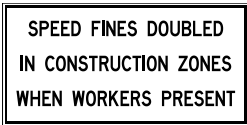
| TC-90 |
|---|
| SPEED FINES DOUBLED |
|  |
| <p>Minimum Background Reflectivity: Engineering Grade (Type I)</p> |

Purpose:

The TC-90 sign may be used to inform drivers of doubled fines for speeding in a designated construction zone.

Conditions:



The Road Authority must establish and sign a designated construction zone in order for the doubled fines to be in effect. The RB-90 signs may be installed at regular intervals throughout a designated construction zone to encourage compliance with the posted regulatory speed limit, however, the RB-90 signs are not required for the doubled speed fines to be in effect.

Size:

900 mm x 900 mm

1200 mm x 2400 mm (when used on MTO highways)

Construction Zone Signs

| Rb-90A | Rb-90B |
|---|---|
| CONSTRUCTION ZONE BEGINS | CONSTRUCTION ZONE ENDS |
|  |  |
| Minimum Background Reflectivity: Engineering Grade (Type I) | |

Purpose:

The Rb-90A and Rb-90B signs are used to indicate the limits of a designated construction zone.

Conditions:

The Rb-90A CONSTRUCTION ZONE BEGINS sign must be installed at the beginning of the construction zone.

The Rb-90B CONSTRUCTION ZONE ENDS sign must be installed at the end of the construction zone.

The Rb-90A and Rb-90B signs are required on projects where the road authority has established a reduced regulatory speed zone. Refer to [Section 2](#) for designating a construction zone.

Size:

600 mm x 900 mm

Yield Sign

| Ra-2 |
|---|
| YIELD |
|  |
| Minimum Background Reflectivity: High Intensity (Type III) |

Purpose:

The YIELD Sign (Ra-2) may be used where it is considered necessary to advise drivers of construction vehicles who are exiting from work areas into travelled traffic lanes that they must yield to traffic in those lanes. The YIELD TO ONCOMING TRAFFIC sign (Rb-91) must not be used for this purpose.

Conditions:



The use of the Ra-2 YIELD sign for control of normal road traffic is described in OTM Book 5 (Regulatory Signs).

Size:

750 mm x 750 mm

900mm x 900mm (oversized)

Yield To Oncoming Traffic Sign

| Rb-91 | Wb-1A |
|---|---|
| YIELD TO ONCOMING TRAFFIC | YIELD AHEAD |
|  |  |
| Minimum Background Reflectivity: High Intensity (Type III) | Minimum Background Reflectivity: Engineering Grade (Type I) |

Purpose:

The Rb-91 YIELD TO ONCOMING TRAFFIC sign is used to advise road users that they are required to give the right of way to oncoming traffic in a shared lane.

Conditions:

The Rb-91 YIELD TO ONCOMING TRAFFIC sign must only be used:

- on two-lane, two-way roadways, where only one lane is available for traffic, and
- the traffic volume is too low (less than 3000 veh/day) to warrant the installation of a signal system or use of TCP's on duty for 24 hours a day, and
- where the work zone is shorter than 150m, and
- where there is unobstructed visibility of on coming traffic in both directions.

The sign must only be installed in the direction of the closed lane and located at a distance in advance of the lane closure specified in the appropriate table (Table A or B: 5*).

The sign must be covered or removed when a TCP is on duty. A Wb-1A sign should be used in conjunction with the Rb-91 sign where traffic is approaching at high speed and an advance warning for the one lane traffic control is considered essential. The use of the YIELD AHEAD sign for the control of traffic is described in OTM Book 6 (Warning Signs).



Size:

RB-91 900mm x 1200mm

Wb-1a 750mm x 750mm

900mm x 900mm (oversized)

Do Not Use Radio Transmitter Signs

| TC-44 | TC-45 |
|---|---|
| DO NOT USE RADIO TRANSMITTER | RESUME USE OF RADIO TRANSMITTER |
|  |  |
| Minimum Background Reflectivity: Engineering Grade (Type I) | |

Purpose:

The TC-44 sign must be installed where blasting is being done, whenever an electrical detonating system is in use adjacent to a highway.

Conditions:

The TC-44 sign must be installed 1 km in advance of the blasting area.

The TC-45 sign must be installed in conjunction with the TC-44 DO NOT USE RADIO TRANSMITTER sign where blasting is being done, whenever an electrical detonating system is in use adjacent to a highway. The sign must be installed 1 km past the end of the blasting area.

Size:

600 mm x 900 mm

Road Closed Sign

| Rb-92 |
|--|
| ROAD CLOSED |
|  |
| Minimum Background Reflectivity: High reflectivity micro-prismatic fluorescent (Type III) |

Purpose:

The Rb-92 ROAD CLOSED sign must be used where, due to construction or other activities, a roadway must be temporarily closed.

Conditions:

Requirements are detailed in OTM Book 5 (Regulatory Signs). Use of the Rb-92 must comply with Subsections 28(3) and 102(3) of the Public Transportation and Highway Improvement Act R.S.O. 1990. The regulations on road closings by the Ontario Municipal Board must be precisely followed and where these exist, full information should be obtained from the appropriate traffic authority.

Size:

900 mm x 1200 mm

Typical Information Signs

The following specifications, TC-61 through TC-81, provide examples of typical information signs. Additional details regarding the use and specifications for information signs should be obtained from the road authority. On MTO highways, the regional Traffic Office should be contacted for signing requirements and further guidance can be found in *Temporary Conditions Traffic Management: Advance Notification, Advance Warning and Alternative Route Signing (2001)*, and any subsequent revisions.

New Roadway Open Sign

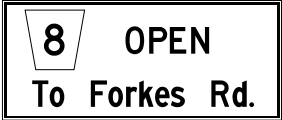
| |
|---|
| TC-61 |
| NEW ROADWAY OPEN |
|  |
| Minimum Background Reflectivity: Engineering Grade (Type I) |

Purpose:

The TC-61 sign is to be used to inform potential users that a new road is open.

Conditions:

The TC-61 sign, when used, must be installed approximately 1 km in advance of the best alternative route and 1 km in advance of the beginning of the new highway section.

The sign is to be removed one year after it is installed.

Size:

1200 mm x 2100 mm

Alternate Highway Route Sign

| |
|---|
| TC-62 |
| ALTERNATE HIGHWAY ROUTE |
|  |
| Minimum Background Reflectivity: Engineering Grade (Type I) |

Purpose:

The TC-62 sign is to be used to indicate an alternate route around the closed area of a through highway. The alternative route can either be designated by road name or detour route.

Conditions:

The TC-62 sign, when used, must be installed 100 m beyond the TC-66 HIGHWAY SECTION CLOSED sign.

Size:

1200 mm x 2400 mm

Road Closing/Restriction Notice Sign (Full-Time)

| | | | |
|--|-------------|--------------|----------------------|
| TC-64 | | | |
| ROAD CLOSING/RESTRICTION NOTICE (Full-Time) | | | |
| <table border="1"> <tr> <td style="text-align: center;">This Access</td> </tr> <tr> <td style="text-align: center; background-color: #FFA500;">To Be Closed</td> </tr> <tr> <td style="text-align: center;">JUNE 18 11 PM - 9 AM</td> </tr> </table> | This Access | To Be Closed | JUNE 18 11 PM - 9 AM |
| This Access | | | |
| To Be Closed | | | |
| JUNE 18 11 PM - 9 AM | | | |
| Minimum Background Reflectivity: Engineering Grade (Type I) | | | |

Purpose:

The TC-64 sign must be installed to provide advance notice of a road or exit ramp which is to be closed or restricted.

Conditions:

The TC-64 sign must be installed at least one week prior to the actual closing date. For a Freeway ramp closure, the TC-64 sign is to be located in advance of the first guide sign that pertains to the interchange so that there is no interference with

existing guide signs and removed immediately after the closing of the ramp. For other locations, the TC-64 sign should be located approximately 1 km in advance of the best alternative route. The regulations on road closings by the Ontario Municipal Board must be precisely followed and where these exist, full information should be obtained from the appropriate traffic authority.

Size: 1200 mm x 2400 mm

Road Closing Notice Sign

| | |
|--|--|
| TC-65 | |
| ROAD CLOSING NOTICE | |
| <table border="1"> <tr> <td style="text-align: center;"> THIS STREET WILL BE CLOSED JAN 10 FOR 2 WEEKS </td> </tr> </table> | THIS STREET WILL BE CLOSED JAN 10 FOR 2 WEEKS |
| THIS STREET WILL BE CLOSED JAN 10 FOR 2 WEEKS | |
| Minimum Background Reflectivity: Engineering Grade (Type I) | |

Purpose:



The TC-65 sign is to be installed to provide advance notice of a street which is to be closed or restricted on a temporary basis.

Conditions:

The TC-65 sign must be installed at strategically selected locations of the street at least one week prior to the actual closing date of the street. It must be removed immediately after the street has been closed.

Size: 1200 mm x 1200 mm

Highway Section Closed Sign (Advance)

| | |
|---|---|
| TC-66 | |
| HIGHWAY SECTION CLOSED | |
| <table border="1"> <tr> <td style="text-align: center;">  CLOSED AT KING ST. </td> </tr> </table> |  CLOSED AT KING ST. |
|  CLOSED AT KING ST. | |
| Minimum Background Reflectivity: Engineering Grade (Type I) | |

Purpose:

The TC-66 sign must be installed to inform motorists of a section of through highway that is closed.

Conditions:

This sign must be installed 1 km in advance of the best detour route. In urban areas, a reduced size sign may be used.

Size: 1200 mm x 2100 mm

Street Section Closed Sign (Advance)

| |
|---|
| TC-67 |
| STREET SECTION CLOSED |
|  |
| Minimum Background Reflectivity: Engineering Grade (Type I) |

Purpose:

The TC-67 sign must be installed to inform motorists that a street on which they are driving will be closed at its junction with a designated side road.

Conditions:

This sign must be installed 1 km in advance of the signed detour turn off. In urban areas, a reduced size sign may be used.

Size:

1200 mm x 2100 mm

Contract Identification Signs (Road Authority) (not shown)

Purpose:

The TC-71 is a generic sign number reserved for contract identification signs installed by the road authority to identify a road construction project, its length, and the road authority responsible. This sign is not shown as its design may vary from road authority to road authority.

Contract Identification Sign (Joint project)

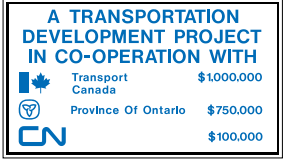
| TC-72A | TC-72B |
|---|---|
| CONTRACT IDENTIFICATION (Joint Project) | CONTRACT IDENTIFICATION (Joint Project) |
|  |  |
| Minimum Background Reflectivity: Engineering Grade (Type I) | |

Purpose:

The TC-72A and TC-72B signs must be installed on projects for road-rail grade separations when a successful application has been made under Part 11 of Bill C-27 of the Railway Relocation and Crossing Act.

Conditions:

These signs must specifically show the extent of financial involvement for each of the participants.

On municipal projects where Transport Canada, the Province of Ontario, a municipality, and railway are involved, the TC-72A sign must be installed. On provincial projects where only Transport Canada, the Province of Ontario, and the railway are involved, the TC-72B sign must be installed.

The TC-72A and TC-72B signs must be installed in advance of the CONSTRUCTION AHEAD sign closest to the construction site at the distance specified in the appropriate table (Table A, B, or C: 5*).

Size:

1200 mm x 2100 mm

Contract Identification Sign

| TC-73A | TC-73B |
|--|---|
| CONTRACT IDENTIFICATION (Connecting Link Project) | CONTRACT IDENTIFICATION (Development Road Project) |
| | |
| Minimum Background Reflectivity: Engineering Grade (Type I) | |

Purpose:

The TC-73A CONTRACT IDENTIFICATION (Connecting Link Projects) sign is to be installed to identify construction projects on connecting links for which cost sharing has been provided by the MTO. The TC-73B CONTRACT IDENTIFICATION (Development Road) sign is to be installed to identify construction projects on development roads for which cost sharing has been provided by the MTO.

Conditions:

The signs must be installed only if the municipality or township has no objections to the installation of such signs. On railroad grade separation projects, the standard TC-72A or TC-72B CONTRACT IDENTIFICATION (Joint Project) sign should be used instead of the TC-73A or TC-73B sign. For connecting link projects which are administered by the MTO, the standard TC-71 CONTRACT IDENTIFICATION sign will be used instead of the TC-73A sign.

Two signs will normally be required for each project, one at each end of the section under construction. The TC-73B sign must be installed in advance of the CONSTRUCTION AHEAD sign closest to the construction site at the distance specified in the appropriate table (Table A, B, or C: 5*).

Size: 1200 mm x 2100 mm

Contract Identification Sign (Municipal Project)

| TC-74 |
|--|
| CONTRACT IDENTIFICATION (Municipal Project) |
| |
| Minimum Background Reflectivity: Engineering Grade (Type I) |

Purpose:

The TC-74 sign is to be installed in advance of a construction area to indicate that the following construction is being done by the municipality under the contract number shown as part of the sign.

Conditions:

Two signs will normally be required for each project, one at each end of the section under construction. The TC-74 sign must be installed in advance of the “Construction Ahead” sign closest to the construction site at the distance specified in the appropriate table (Table A, B, or C: 5*).

Size: 1200 mm x 2100 mm

Contractors Identification Sign

| |
|---|
| TC-75 |
| CONTRACTOR'S IDENTIFICATION |
|  |
| Minimum Background Reflectivity: Engineering Grade (Type I) |

Purpose:

The TC-75 sign may be erected by the prime contractor or contract administrator of the prime consultant for identification.

Conditions:

The TC-75 sign may be installed either directly beside the TC-71, TC-73, or TC-74 sign, or in the case of insufficient space, just past the CONTRACT IDENTIFICATION sign.

When used, the sign shall only give the contractor's name and telephone number.

The background colour shall not be red, yellow, or orange, and the sign may be non-reflectORIZED.

Size: 900 mm x 1800 mm maximum

Contract Information Signs

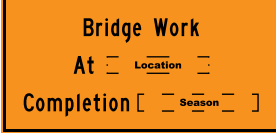
| | |
|---|---|
| TC-81A | TC-81D |
| CONTRACT INFORMATION SIGNS | CONTRACT INFORMATION SIGNS |
|  |  |
| Minimum Background Reflectivity: Engineering Grade (Type I) | |

Purpose:

The TC-81 sign is to be installed to inform motorists of highway improvements (TC-81A), highway widening (TC-81B), highway resurfacing (TC-81C), bridge work (TC-81D), COMPASS installation (TC-81E), new traffic signals (TC-81F), new interchange (TC-81G),

dock work (TC-81J), tunnel work (TC-81K), and new intersection (TC-81L). Signage for highway improvements, widening and resurfacing, as well as COMPASS installation, will be displayed as shown for TC-81A. Signage for bridge work, new traffic signals, new interchange, dock work, tunnel work, and new intersection will be displayed as shown for TC-81D.

Conditions:

The sign must be installed on each approach to the contract area. The sign should not obscure any other regulatory or warning signs.

Size: 1200 mm x 2100 mm

NOTE

The TC-12 sign must not be used in arrow mode on two-lane roads.

6.3.6 TC-12 Flashing Arrow Board Sign

Flashing Arrow Board Sign

TC-12 (in left arrow mode)

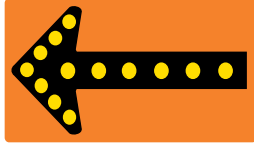

TC-12 (in bar mode)

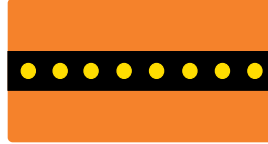

TC-12 (in right arrow mode)

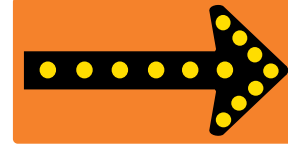

Purpose:

The TC-12 FLASHING ARROW BOARD sign is used to indicate lane closures in stationary or mobile work operations and must be mounted on vehicles or trailers. Placement is as shown in the typical layouts.

Conditions:

Multi-lane Roads

In stationary work operations within the coned area, one TC-12 sign in arrow mode should be used at the end of each taper to indicate that one lane shift is required. Any additional TC-12 signs, in the same lane downstream, should be in bar mode to indicate that the vehicle/trailer on which the TC-12 is mounted is in a closed lane (or on the shoulder), but that no further lane shift is required.

One TC-12 sign in arrow mode may also be used as an advance warning sign on the shoulder.

In mobile work operations a TC-12 in arrow mode is used to indicate the direction in which the traffic is permitted to pass. When a sign truck/buffer vehicle(s) follows a work vehicle, at a distance of LIDG, the TC-12 on the buffer vehicle(s) shall be in arrow mode and the TC-12 on the work vehicle shall be in bar mode. When no sign truck/buffer vehicle is present, the TC-12 on the work vehicle shall be in arrow mode.

TC-12s should be used in bar mode for shoulder work, except during setup/removal of traffic control devices.

Two Lane Roads

In mobile operations, the TC-12 sign should be used in bar mode (where a flashing arrow could suggest to drivers that they can safely overtake the work/BV).

In stationary operations, the TC-12 sign must be used in bar mode only. The TC-12 must not be used in arrow mode.

TC-12s should be used in bar mode for shoulder work, except during setup/removal of traffic control devices.

The TC-12 sign must not be used in arrow mode with:

- a TCP;
- an AFAD (remote control device);
- a portable lane control signal, or a PTTS; or
- A YIELD TO ONCOMING TRAFFIC sign.

The both arrow mode should only be used under low speed (60km/hr or less) traffic conditions.

Required visibility distance by day or night for the TC-12 sign is as follows:

- For speeds of 90 km/h or greater, the distance must be 900 m with the flashing lights on, and 350 m for the recognizable arrow or bar shape.
- For speeds of 70 km/h to 90 km/h, the distance must be 600 m with the flashing lights on, and 250 m for the recognizable arrow or bar shape.
- For speeds of 60 km/h and lower, the distance must be 450 m with the flashing lights on, and 175 m for the recognizable arrow or bar shape.

Sign Panel

- The black arrow silhouette design and orange reflective background (to act as a fail-safe device) must be used on all TC-12 signs.
- The panel shall be one-piece design, equipped with remote-controlled mode activation mechanisms mounted on the panel.
- The actuation time of the mode activation mechanisms from the closed position to the open position or vice versa shall be 10 seconds maximum.
- The arrows and arrow shaft (bar) shall be black in colour.
- The background must be Type III, high intensity, retroreflective orange sheeting, to provide for fail-safe operations in case of power failure.

Sign Panel Lighting

- The sign panel should incorporate four illumination modes: right arrow, left arrow, both arrows, and bar mode. Only one mode shall be visible at a time to the approaching traffic, and only the lights within the operating mode shall be visible.

NOTE

- The amber lights on all TC-12 signs must flash simultaneously or sequentially to increase the conspicuity and attention-getting value of the arrow. For night use, the light intensity must be reduced.
- For use on freeways, the TC-12 sign must have 15 to 19 amber halogen lamps, or LED lamps that meet the required visibility distances as prescribed above, or the equivalent as approved by the road authority. The lights that meet the required visibility distances (as prescribed above) shall be arranged in the form of an arrow. The smaller TC-12 signs (non-freeway, stripers, emergency) must have sufficient lights to provide distinct arrow and bar shapes with a minimum of 12 lamps for non-freeways and 14 lamps for stripers.
- The arrow head and shaft shall flash simultaneously (arrow on/off). Alternatively, the arrow shaft and head may flash sequentially, with the arrow shaft coming on first and then the arrow head, the shaft remaining on so that at the end of the cycle, the complete arrow appears (shaft and head).
- A photo-electric cell with 110 lux (10-foot candelas) sensitivity for the night dimmer shall be supplied to automatically reduce lamp intensity.
- The lights shall flash approximately 40 to 50 times per minute. The “ON” phase must be on for 50% of the cycle time.

Electronic Controller

- The controller shall operate the following functions (from inside the cab, if truck-mounted) (some of these functions may be automatically adjusted):
 - the left flashing arrow;
 - the right flashing arrow;
 - the bar mode;
 - the both arrow mode if present;
 - the specified flashes per minutes;
 - the light intensity; and
 - the remote controlled mode activation mechanisms.

Crashworthiness

Since trailer-mounted TC-12 signs are often located on the roadway, they should be crashworthy. The design should be lightweight with the centre of gravity of the unit near or below that of impacting vehicles. If impacted, detached elements, fragments, or other

debris from the device should not penetrate or show potential for penetrating the passenger compartments of vehicles or present undue hazard to the public or workers.

Only TC-12s which conform to the requirements stated in OTM Book 7 may be used as a replacement for the TC-3 and TC-4 signs in SD operations where shown on various typical layouts. The TC-12 sign must be mounted at a minimum of 1.5 m above the roadway to qualify as a replacement device for other traffic control devices.

Size:

600 mm x 750 mm - non freeways (bar/arrow shaft size 150mm x 750mm, minimum 12 amber halogen or LED lamps)

1200 mm x 2100 mm - freeways (bar/arrow shaft size 300mm x 2100mm, 15 to 19 amber halogen or LED lamps)

600 mm x 1500 mm - striper truck mounted. (bar/arrow shaft size 150mm x 1500mm, minimum 14 amber halogen or LED lamps). May be used for freeway paving operations, freeway patrol, or freeway emergency response only.

6.3.7 Portable Variable Message Signs (PVMSs)

The road authority must approve the use of PVMSs in work zones. PVMSs are always in addition to the sign requirements in OTM Book 7 and never replace any of the OTM Book 7 signs.

PVMSs should not be used if standard traffic control devices adequately provide the information that road users need to travel safely.

On MTO highways a PVMS may be used in the following conditions (with duration not exceeding 9 days):

- Advanced notification of continually changing roadway situation (hour by hour).
- Advanced notification of closures due to construction or maintenance.
- Advanced notification of major special events that will impact traffic.
- Notification of short-term lane closures and detours during construction, maintenance and special events.

6.3.7.1 Physical Specifications

A brief description of the physical aspects that must be considered when PVMSs are to be used on MTO highways is provided here. Technical specifications for

NOTE

NOTE

PVMSs are included in OTM Book 10 (Dynamic Message Signs) and PVMS Best Practices Manual (developed by the MTO, May 2009). The road authority should be contacted to provide details on the technical and operational requirements.

Display Elements

Signs shall have a 30 pixel high by 56 pixel wide full matrix amber display. The colour of all pixels should be uniform across the display. Each PVMS pixel should be capable of achieving a luminance of 40 candelas at the brightest level. The PVMS should incorporate a photocell control system to automatically adjust the brightness as a function of the ambient light level (brighter during the day, dimmer at night). The luminance of a PVMS pixel should not decrease by more than 50% when viewed at a minimum angle of 15 degrees centred about the optical axis and perpendicular to the surface of the display (half angle of 7.5 degrees).

The sheeting which covers the display elements also has an effect on the legibility of the sign. The sheeting material should minimize glare and reflection in all lighting conditions.

Contrast ratios, technology details, and line and character spacing and fonts should be designed as outlined in OTM Book 10 (Dynamic Message Signs). It is important that the display elements conform to the specifications, as this will have an effect on the overall legibility of the sign.

Sign Case

The sign case is the structure that protects the display elements and associated electronics from the elements. The MTO PVMS specification details the identifiers which would go on the PVMS sign case, physical requirements of the sign case, as well as the specification for the retroreflective border to go around the front outside edge of the sign case to improve the target value of the sign.

Solar Panels

Solar panels should be supplied with each sign by default. If signs are subsequently deployed in areas where they can be hardwired with power, the solar panels can be removed to prevent theft and vandalism. Solar panels should be able to tilt and rotate so they can be aimed towards the sun.

Electrical System

The electrical system provided with a PVMS shall be able to operate the sign by using a hardwired power supply or batteries recharged by solar panels or a trickle charger.

Global Positioning System (GPS)

The purpose of having a GPS system as an integral part of the PVMS is to know the position of the sign at any given time. As a fleet of PVMSs can be used anywhere in any given region, an increased effort is required to track them. A simple misunderstanding which leads to the misplacement of a single sign can create operational issues or display of incorrect information, especially if it is not caught quickly. The worst effect of this confusion would be to have messages sent to the wrong signs due to misunderstanding of their true location. A GPS unit that is integrated with the sign controller allows for continuous updating of the PVMS location.

Sign Face Compass

The purpose of the sign face compass is to provide the ability to monitor and record the direction of the PVMS sign face. Due to the large surface area of the sign face, high winds may cause the sign face to rotate even through there is a braking mechanism in place to prevent the sign face from rotating on its own. In extreme cases, winds could cause the entire PVMS to shift. In situations where poor legibility of a PVMS is reported, the operator could check through the software on the current direction of the sign face, thereby confirming whether the poor legibility is due to a rotated sign face. The compass also supports in determining sign location. The GPS will generally not provide an accurate enough location to determine which side of the road that a sign is on for two-lane roads. The compass will show the direction of travel that the sign is facing to allow confirmation of the side of the road that it is on. Compass functionality may be included as part of the GPS by some manufacturers.

Communication Protocol and Control

To ensure all the signs that are available to a given control centre can communicate from the same central software, it is necessary to use a standard communications protocol. The National Transportation Communications for ITS Protocol (NTCIP) that

NOTE

has been developed in the USA through a number of standards agencies (AASHTO, NEMA, etc.) provides an appropriate level of standardization for communication protocols for PVMS and is required for all new PVMSs in the province.

The Regional COMPASS Traffic Operations Centre or Communications Centre controls all PVMSs messages on provincial highways, whether it is a contractor or MTO owned sign, or a sign rented from a third party. This control can range from full messaging responsibility to simply the ability to blank or override a sign message when necessary. To enable this communication, it is imperative that supplied signs comply to MTO communication standards.

6.3.7.2 Site Selection and Installation of PVMS

The location of a PVMS must ensure adequate visibility, roadside safety, and consider the availability of power and communication.

The horizontal and vertical geometries of a highway will have the greatest effect on the visibility of a sign. Whenever possible, the sign should be placed on a tangent section of the highway, while maintaining the intent of the message content.

On freeways, PVMSs should be located 1000 m to 1500 m upstream of interchange decision points. On arterial roads, they should be located 600 m to 1000 m upstream of decision points. If multiple PVMSs are located close together, but show only one language, a minimum longitudinal distance of 150 m should separate the signs to allow drivers to read and process the first sign before they see the second one.

PVMSs should not obstruct, and should not be obstructed by, any existing signs or other objects.

PVMSs should not obstruct, and should not be obstructed by, any existing signs or other objects. PVMSs need to be sufficiently away from nearby ground-mounted static signs. This way, the motorists can focus their attention on the PVMS message without being distracted by other signs.

When placing a sign within the limits of a construction zone, ensure that it does not interfere with construction operations.

A PVMS can become a roadside hazard to the travelling public. Therefore, PVMSs should be placed outside the clear zone for a given section of highway or placed behind a section of guide rail. The PVMS should be far enough behind a guide rail to account for the deflection angle of the given guide rail style. When

locating the PVMS, it is important to remember that the sign head is significantly wider than the trailer when in the display position. On municipal roadways if it cannot be protected by a guardrail or barrier, then it is recommended that orange cones or drums be used.

The signs shall be installed level. The bottom of the sign display shall be at least 1.5 m above the adjacent edge of the pavement elevation. The signs shall be set at the proper angle to traffic to maximize the time that drivers are viewing the sign in the centre of the viewing angle. With such a narrow angle of good luminance, sign positioning (angle) in work zones becomes critical.

A sight tube for aiming the device is required on new PVMSs. The sign should be aimed such that the message is legible from at least 300 m for freeway applications and at least 200 m for arterial road applications.

6.3.8 Message Guidelines

The PVMS must provide road users with a concise message relevant to the situation they will be encountering. The providing of accurate information will enhance the system credibility and effectiveness. PVMSs used on construction projects and maintenance activities should be treated as an integral part of the traffic control plan. Desired messages, locations, and general time periods of display should be listed for all known or anticipated PVMSs use during the project.

The ITS Program sections and the Regional Traffic Office must approve all PVMS messages used on signs located on provincial highways. Pre-approved messages should be stored either a) locally in the PVMS or b) centrally in the server that runs the PVMS application as per the Regional requirements. This prevents spelling errors, missed words, or incoherent/ineffective messages being displayed.

When not in use, the PVMS should be turned parallel to the flow of traffic so that motorists do not see its screen (if possible).

Message Format

The format of the message is an important criterion. Road users must receive the information in a manner consistent across the province. This will help motorists understand the message easily and have sufficient time to react accordingly. The format must be developed so that drivers can quickly determine if a message does

NOTE

The ITS Program sections and the Regional Traffic Office must approve all PVMS messages used on signs located on provincial highways.

When not in use, the PVMS should be turned perpendicular to the flow of traffic so that motorists do not see its screen.

NOTE

not apply to them. For example, placing the name of the connecting roadway first in the message immediately targets only drivers who are interested in using the identified road.

Units of Information/Major Words

A unit of information answers a specific question, such as, ‘What happened?’, ‘Where did it happen?’, and ‘What are its effects?’ For example, each of the following is a unit of information.

- What highway? 417 WEST
- Where? AT MAITLAND
- What is happening? LANE REDUCTION
- When? At 10 PM

A typical weather warning message is shown below:

DRIFTING SNOW POSSIBLE DRIVE WITH CAUTION

In the above example, the first phase contains three major words; “DRIFTING”, “SNOW” and “POSSIBLE”. The second phase has two major words: “DRIVE” and “CAUTION”. The “WITH” is not considered a major word. “DRIVE WITH CAUTION” could also be considered as a unit of information because it expresses a single thought.

Multi-phase Messages

A phase refers to a message segment, which is individually displayed. For example, the first phase of a message could be “Maitland Ave Exit” and the second phase could be “Closed Until 9 am”.

A maximum of two phases per sign is permitted under normal circumstances.

Human factor studies have shown that there is neither sufficient reading time for more than two phases nor have the majority of drivers shown the ability to retain more than two phases of information.

When designing a two-phase message, the wording must make sense regardless of which phase the driver reads first.

A maximum of two phases per sign is permitted under normal circumstances.

Each phase should contain a complete thought. Multi-word units of information shall not be broken across phases.

The following are message guidelines for the number of phases that are required to convey a message:

One-Phase PVMS:

Line 1—Describe effect to the road or access.

Line 2—Identify location or distance ahead.

Line 3—Provide motorist instruction.

Two-Phase PVMS:

Phase 1—Describe effect to the road or access.

Phase 2—Provide motorist instruction.

Use of Alternate Display Techniques

A number of alternate display techniques, usually associated with advertising signs, are technically possible in the control of PVMS for highway use. These include:

- Message flashing, where the message cycles on and off several times a minute to draw the observer's attention to the message. This can occur with all or part of the message. Flashing messages take longer to read than static messages and are not to be used.
- Message alternating, where two physically separate signs, which are close enough to be perceived by drivers as a pair, are used to convey parts of a message. With the exception of bilingual applications, this approach is inconsistent with other types of signing on the roadway. It has been shown to be confusing to drivers, and shall be avoided.
- Message scrolling, where the message appears to scroll from right to left across the screen or top to bottom to accommodate longer messages than otherwise possible. Message scrolling requires significantly more attention from drivers, as they cannot just glance at the message, but must watch it scroll. This constitutes a potentially hazardous distraction and shall not be implemented.

In summary, message flashing, alternating, or scrolling are not allowed for MTO PVMS installation, as these messages require extra time to read. This extra time constitutes a distraction for drivers and is potentially hazardous and therefore undesirable.

NOTE

Flashing messages take longer to read than static messages and are not to be used.

Message alternating has shown to be confusing to drivers, and shall be avoided.

NOTE

All French translations must be approved by the road authority.

Signing in Designated Bilingual Areas

All French translations must be approved by the road authority.

Given the current industry standard, many PVMSs are capable of displaying three lines of text. As a result, two approaches for PVMSs messages are permissible for use in Ontario's designated bilingual areas. From a human factors perspective, the preferred approach is to use two PVMS – one for each language. The other permissible approach, though less effective, is to use a single PVMS to display the two-phase messages where each phase is used for one language.

To determine which approach to use, it is necessary to review all of the messages that are intended for the location. If they can all be fit on one phase for English and one phase for French, then a single sign will suffice. Otherwise, two signs are required.

If multiple PVMSs are located close together but only show one language, a minimum longitudinal distance of 150 m should separate them. This will allow sufficient time for drivers to read and process the message on the first PVMS before seeing the second one. In the case of two signs, each with a different language, they do not need to read both signs and the spacing may be reduced to 75 m. However, when setting up the signs, care must be taken so that the first sign does not block the view of the second sign. If the view is being blocked, the distance between the signs may need to be increased. The sign that displays the English message should always be first so that this setup will be consistent across the province and drivers will become accustomed to it.

7

Quality Replacement Guidelines for Traffic Control Devices

Traffic control devices are an important part of a work zone. Traffic control in work zones depends upon good visibility and legibility of the traffic control devices used. Once a construction site has been correctly equipped with all necessary signs, markings and other devices, they must be maintained in optimum operational condition. Section 25 (1)(b) of the OHSA places responsibility on employers to ensure that equipment, materials, and protective devices are maintained in good condition.

Traffic control devices in work zones are often subjected to hard use, wear, and damage due to the nature of storage, transport, installation, removal, and relocation of devices for temporary conditions. This may result in loss of effectiveness due to soiling, deformation, gashes, breakage, and loss of/damage to reflective sheeting, text, or symbols.

Some degradation of devices can be accommodated without significant loss of effectiveness and it is not practical to require new devices at all times. However, a standard of quality must be maintained. The quality replacement guidelines are to be used to determine when used devices need to be replaced for continued effectiveness.

7.1 Quality Guidelines

All traffic control devices used in MTO work zones must conform to the requirements of OTM Book 7 and contract documents with regard to size, shape, colour, placement, and legend and this compliance must be maintained for the duration of the project.

Device quality should be evaluated at various stages, including storage, preparation for drop off at a work zone, installation, and regularly during the course of the work. Good quality control throughout the various stages of the work will reduce costs and minimize the need for replacement on-site.

Traffic control device placement should be routinely inspected. Signs should be as near vertical as practicable. Any situation where there are more than two adjacent channelizing devices missing or substantially out of alignment will cause an unacceptable situation and should be corrected immediately.

NOTE

Device quality should be evaluated at various stages.

NOTE

Traffic control devices should routinely be inspected at night.

The percentage of acceptable devices on a work project should be at least 50% at any time, or as contained in the contract specifications or road authority requirements.

Traffic control devices should routinely be inspected at night to assure that the level of retroreflectivity is adequate and the devices are clearly visible and legible.

For the purpose of this manual, the quality of work zone devices has been divided into three categories:

- **Acceptable devices**, which meet the quality requirements outlined herein and all design, size, and colour requirements, and may be used on highway construction, maintenance, utility and other projects. The percentage of acceptable devices on a work project should be at least 50% at any time, or as contained in the contract specifications or road authority requirements.
- **Marginally acceptable**, which are devices at or near the lower end of acceptability. Such devices may be used until they become unacceptable. The percentage of marginally acceptable devices on a work project should not exceed 50% at any time, and if used, should be interspersed with acceptable devices so that a sizeable length of a work zone does not have all marginally acceptable devices.
- **Unacceptable devices**, which should not be delivered to the work site, or used on a work project, and should be replaced or repaired within 12 hours of notification, or as contained in the contract specifications or road authority requirements. Where 10% or more of the surface of a traffic control device, or 20% of the retroreflective material on the traffic control device is damaged or missing, the device is unacceptable and should be removed from service.

The 50% acceptability criterion outlined above applies to each traffic control device type taken by itself. (e.g., 50% of Barrels, 50% of TC series signs, 50% of Delineators etc.)

For key communication items in a work zone, if the message or symbol on a traffic control device becomes unclear, the device is unacceptable.

7.2 Evaluation Guide

The selected traffic control devices illustrated in Figures 15 to 18, together with the accompanying descriptions, should be used as a guide to determine whether a device is acceptable, marginally acceptable, or unacceptable. Such assessments are somewhat subjective, and devices can be worn or damaged in a wide variety of ways. All worn or damaged states cannot be practically depicted.

7.2.1 Work Zone Signs

NOTE

Figure 15 Work Zone Signs Quality Illustration

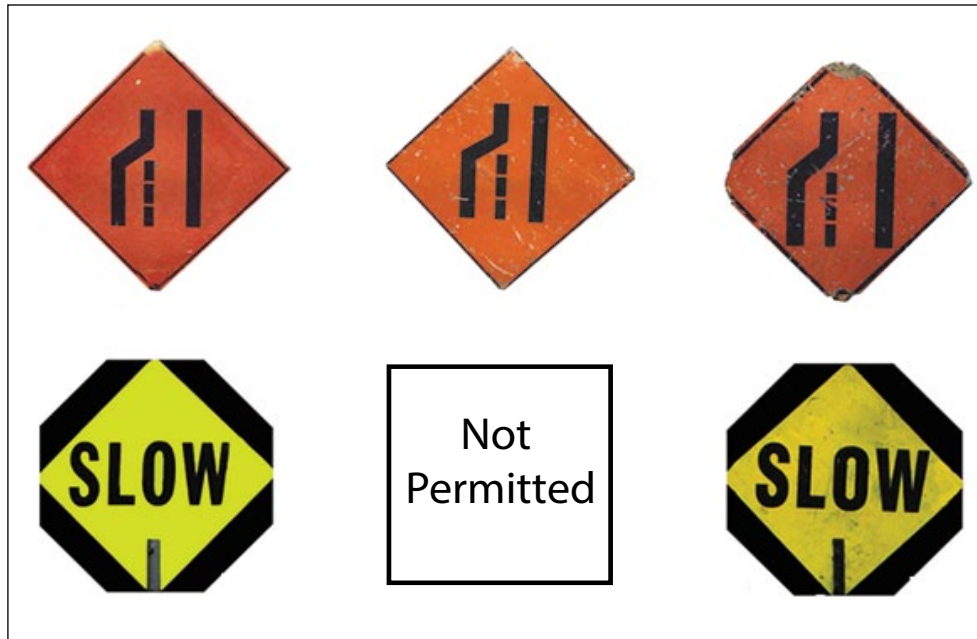

Acceptable

Marginally acceptable

Unacceptable

- **Acceptable:** Minor abrasions, no loss of lettering. The message is legible per design criteria in OTM Book 1b.
- **Marginally acceptable:** Many surface abrasions, including individual letters of message. Sign surface is free of residue. Background colour and reflectivity are still apparent at night. The message is legible per design criteria in OTM Book 1b.
- **Unacceptable:** Many abrasions and/or splatters; significant loss of letters or colour fading. The message is partly missing or illegible per design criteria in OTM Book 1b.

Note: All TC-21 TRAFFIC CONTROL PERSON AHEAD and TC-22 TRAFFIC CONTROL signs (STOP/SLOW paddles) in use must meet the "acceptable" criterion.

NOTE

If 20% of the reflective material is damaged or missing, the device is unacceptable and should be removed from service.

7.2.2 Flexible Drums (TC-54 Barrels)

Figure 16 Flexible Drums (TC-54 Barrels) Quality Illustration



- **Acceptable:** Minor tears and scratches on sheeting. Any dents do not seriously reduce reflectivity. Intended original shape is maintained.
- **Marginally acceptable:** Numerous tears and scratches, but free of large areas of residue or missing or damaged reflective material. Intended original shape and strength are maintained.
- **Unacceptable:** Large areas of missing or damaged reflective material, or significant splatter residue. If 20% of the retroreflective material is damaged or missing, the device is unacceptable and should be removed from service. Substantial deformation alone may render a drum unacceptable.

Note: Barrels (flexible drums) that are dented severely enough to affect their overall dimensions or contain fractures that affect their stability or ability to retain the reflective sheeting are unacceptable.

7.2.3 Cones

NOTE

Figure 17 Cones Quality Illustration



- **Acceptable:** Clearly identifiable conical shape, free standing in its original position. Surface is free of punctures and abrasions, splatter or residue, and is washable. Reflective bands have little or no loss of reflectivity, with only minor tears and scratches.
- **Marginally acceptable:** Some splatters, difficult to clean, minor discolouration. Reflective bands have tears and scratches, but are free of large areas of residue or missing material.
- **Unacceptable:** Punctures, large areas of splatter residue, large areas of missing or stained reflective material.

7.2.4 TC-12 Flashing Arrow Boards

- **Acceptable:** In the flashing arrow mode, not more than one lamp in stem out and none out in arrow head, and properly dimming. In the bar mode, four or more lamps properly operating and dimming.
- **Marginally acceptable:** In the flashing arrow mode, two or fewer lamps in stem out, none out in arrow head, and properly dimming. In the bar mode, minimum of four lamps functioning, and properly dimming.
- **Unacceptable:** In the flashing arrow mode, any lamp out in the arrow head, or three or more lamps in the stem out, or arrow panel not properly dimming.

Note: Any operating lamp which is out of alignment will be considered "not functioning". In the bar mode, if fewer than four lamps are functioning, or not dimming properly, the sign fails to meet the visibility distance criterion outlined in [Section 3](#) (i.e., it will be deemed as a non-recognizable arrow or bar shape).

NOTE

7.2.5 Variable Message Signs (VMS)

- **Acceptable:** 90% or more of the pixels per character module are properly operating.
- **Unacceptable:** Fewer than 90% of the pixels per character module are properly operating, or not performing within the criteria in OTM Book 10 (Dynamic Message Signs), or message clarity is significantly impacted.

7.2.6 Pavement Tape and Paint

- **Acceptable:** All pavement marking tape or paint required (solid lines and skip lines) is in place and meets all material specifications.
- **Marginally acceptable:** No more than 10% of all tape, paint, message, or symbol, or no more than two consecutive skip lines, or no more than 15 continuous metres of solid line are missing.
- **Unacceptable:** More than 10% of all tape, paint, message, or symbol, more than two consecutive skip lines, or more than 15 continuous metres of solid line are missing.

7.2.7 Temporary Raised Pavement Markers (TRPMs)

- **Acceptable:** All TRPMs required are in place and meet all material specifications.
- **Marginally acceptable:** No more than 10% of the total TRPMs or no more than three consecutive TRPMs are missing.
- **Unacceptable:** More than 10% of the total TRPMs or more than three consecutive TRPMs are missing.

The principal responsibility for ensuring that traffic control equipment, materials, and protective devices are maintained in good condition rests with the contractor.

7.3 Monitoring of Contractor Compliance

The principal responsibility for ensuring that traffic control equipment, materials, and protective devices are maintained in good condition rests with the contractor. It is also important that there be periodic monitoring of contractor compliance by the road authority in order for the above quality guidelines to be effective. Quality may decline if monitoring of compliance is not effectively and consistently done.

8

Typical Layouts For Signing Temporary Work Zone Situations

NOTE

The material in this section is organized as follows:

[Table A Work Zone Component Dimensions: Very Short and Short Duration Work \(Non-freeways\)](#)

[Table B Work Zone Component Dimensions: Long Duration Work \(Non-freeways\)](#)

[Table C Work Zone Component Dimensions: Freeways](#)

[Table D Application of Longitudinal Buffer Area and Lateral Intrusion Deterrence Gap](#)

[Table E Typical Usage of Signs through a Temporary Work Zone](#)

[Table F Usage of Channelizing Devices, Barricades, and Barriers](#)

[Table G Decision Matrix: Typical Layouts](#)

[8.1 General Notes to Typical Layouts:](#)

[8.1.1 Legend of Symbols used in the Typical Layouts](#)

[Typical Layouts - Figure TL-1 to TL-93](#)

Table A Work Zone Component Dimensions: Very Short and Short Duration Work (Non-freeways)

| | | Normal Posted Regulatory Speed Limit ** | | | | |
|-----|---|---|--------------------|--------------------|--------------------|--------------------|
| | Dimension | 50 km/h or lower | 60 km/h | 70 km/h | 80 km/h | 90 km/h |
| 1a* | Taper length for full lane closure (m) | 10 – 15 | 20 – 30 | 30 – 40 | 50 – 60 | 70 – 80 |
| 1b* | Taper length for roadside work (m) *** | 3 – 5 | 5 – 7 | 7 – 10 | 10 – 12 | 15 – 20 |
| 2* | Longitudinal buffer area (LBA) (m)**** | (30) | (40) | 50 | 60 | 75 |
| 3* | Maximum distance between markers (m)***** | 4 – 6 | 4 – 6 | 8 – 10 | 8 – 10 | 10 – 12 |
| | Minimum number of markers for taper | at least 4 markers | at least 5 markers | at least 5 markers | at least 7 markers | at least 8 markers |
| 4* | Minimum tangent between tapers (m) | 30 | 30 | 60 | 60 | 80 |
| 5* | Distance between construction signs (m) ***** | 20 – 30 | 20 – 30 | 50 – 60 | 50 – 60 | 70 – 80 |

* Table A distances are based on good visibility, and should be increased if visibility is poor.

** The regulatory maximum speed posted on a highway applies under normal conditions; that is, when no construction zone or work activity is present. Guideline provisions required in OTM Book 7 are based on normal posted regulatory speed, and not on temporarily reduced construction zone regulatory or advisory speeds.

*** Roadside work includes shoulder work and roadway edge work.

**** LBAs are optional at speeds of 60 km/h or lower, but should be used for closed lanes on multi-lane roads if space permits.

***** Markers are channelizing devices. Application guidelines are shown in Table F. Cones with reflective collars may be used for daytime or night-time operations on non-freeways.

***** 5* also refers to the required distance for the placement of a TC Warning Sign ahead of the hazard where referenced in section 6.3.5 for the individual signs.

Table B Work Zone Component Dimensions: Long Duration Work (Non-freeways)

| | Dimension | Normal Posted Regulatory Speed Limit** | | | | |
|-----|---|--|--------------------|--------------------|---------------------|---------------------|
| | | 50 km/h or lower | 60 km/h | 70 km/h | 80 km/h | 90 km/h |
| 1a* | Taper length for full lane closure (m) | LV: 15 – 25 HV: 30 – 50 | 40 – 60 | 60 – 80 | 100 – 120 | 140 – 160 |
| 1b* | Taper length for roadside work (m)*** | LV: 5 – 8 HV: 9 – 15 | 10 – 15 | 15 – 20 | 20 – 25 | 30 – 40 |
| 2* | Longitudinal buffer area (LBA) (m)**** | (30) | (40) | 50 | 60 | 75 |
| 3* | Maximum distance between markers (m)***** | 6 – 8 | 8 – 10 | 8 – 10 | 10 – 12 | 12 – 14 |
| | Minimum number of markers for taper | at least 5 markers | at least 7 markers | at least 9 markers | at least 11 markers | at least 13 markers |
| 4* | Minimum tangent between tapers (m) | 55 | 100 | 120 | 140 | 160 |
| 5* | Distance between construction signs (m) ***** | 40 – 50 | 90 – 100 | 110 – 120 | 130 – 140 | 150 |

* Table B distances are based on good visibility, and should be increased if visibility is poor.

** The regulatory maximum speed posted on a highway applies under normal conditions, that is, when no construction zone or work activity is present. Guideline provisions required in OTM Book 7 are based on normal posted regulatory speed, and not on temporarily reduced construction zone regulatory or advisory speeds.

*** Roadside work includes shoulder work and roadway edge work.

**** LBAs are not a requirement at speeds of 60 km/h or lower, but should be used for closed lanes on multi-lane roads if space permits.

***** Markers are channelizing devices. Application guidelines are shown in Table F. Cones with reflective collars may be used for daytime or night-time operations on non-freeways.

***** 5* also refers to the required distance for the placement of a TC Warning Sign ahead of the hazard where referenced in section 6.3.5 for the individual signs.

LV = Low Volume

HV = High Volume

LV is defined as the average daily traffic volume with less than 3000 vehicles per day (combined traffic for both directions). This figure can be obtained from the local road authority or estimated by counting the number of vehicles that pass the work site in 3 minutes and multiplying this figure by 300. The count may be taken in off-peak or peak traffic periods, corresponding to the period during which the work operations will be carried out.

Example: 20 cars in 3 minutes x 300 = 6000 vehicles per day (this would be an HV road).

Table C Work Zone Component Dimensions: Freeways

| * | Dimension | Normal Posted Regulatory Speed Limit** | | |
|-----|---|--|---------|----------|
| | | 80 km/h | 90 km/h | 100 km/h |
| 1a* | Taper length for full lane closure (m) | 220 | 250 | 300 |
| 1b* | Taper length for roadside work (m)*** | 20 - 25 | 30 – 40 | 40 – 50 |
| 2* | Longitudinal buffer area (LBA) (m)**** | 60 | 75 | 95 |
| 3* | Maximum distance between markers (m)***** | 10 - 14 | 18 – 24 | 18 – 24 |
| 4* | Minimum tangent between tapers (m) | 220 | 250 | 300 |
| 5* | Distance between construction signs (m) ***** | 160 | 180 | 200 |

* Table C distances are based on good visibility, and should be increased if visibility is poor.

** The regulatory maximum speed posted on a highway applies under normal conditions, that is, when no construction zone or work activity is present. Guideline provisions required in OTM Book 7 are based on normal posted regulatory speed, and not on temporarily reduced construction zone regulatory or advisory speeds.

*** Roadside work includes shoulder work and roadway edge work.

**** For application of LBA and LIDG, see Table D and Sections 3 and 4.

***** Markers are channelizing devices. Application guidelines are shown in Table F. Cones with reflective collars may be used for daytime VSD or SD operations only. Construction markers or flexible drums must be used for all other conditions.

***** 5* also refers to the required distance for the placement of a TC Warning Sign ahead of the hazard where referenced in section 6.3.5 for the individual signs.

Table D Application of Longitudinal Buffer Area and Lateral Intrusion Deterrence Gap

| Stationary Work Operations | | |
|---|--|---|
| Required Protection (Freeways): LBA + Buffer Vehicle + LIDG | | |
| Required Protection (Non-freeways): LBA only | | |
| (1) Normal Posted Regulatory Speed Limit (km/h) | (2) Longitudinal Buffer Area (LBA) (m) | (3) Lateral Intrusion Deterrence Gap (LIDG) (m) |
| 50 | (30)* | (35)* |
| 60 | (40)* | (40)* |
| 70 | 50 | 50 |
| 80 | 60 | 60 |
| 90 | 75 | 65 |
| 100 | 95 | 70 |

| Mobile Work Operations | |
|---|---|
| (1) Normal Posted Regulatory Speed Limit (km/h) | (2) Lateral Intrusion Deterrence Gap (LIDG) (m) |
| 70 | 35 |
| 80 | 45 |
| 90 | 50 |
| 100 | 55 |

*LBA and LIDG are optional for normal posted regulatory speed of 50 km/h and 60 km/h.

1. See also [Section 3](#) and [Section 4](#).

Table E Typical Usage of Signs through a Temporary Work Zone

| Sign No. | Sign Name | Advance Warning Area | Approach Area | Transition Area | Longitudinal Buffer Area | Work Area | Termination Area |
|----------|---|----------------------|---------------|-----------------|--------------------------|-----------|------------------|
| TC-1 | Construction Ahead | X | | | | | |
| TC-1A | Construction 1 km Ahead | X | | | | | |
| TC-1B | Construction 2 km Ahead | X | | | | | |
| TC-2A | Road Work (square A frame) | | X | | | X | |
| TC-2B | Road Work (diamond portable sign stand) | | X | | | X | |
| Rb-90A | Construction Zone Begins | X | | | | | |
| Rb-90B | Construction Zone Ends | | | | | | X |
| Rb-1 | Maximum Speed (regulatory) | X | X | | | X | |
| Rb-31 | Do Not Pass | X | X | | | X | |
| TC-3 | Lane Closed Ahead | | X | | | | |
| TC-4 | Lane Closure Arrow | | | X | | | |
| TC-5 | Detour Ahead | X | | | | | |
| TC-5A | Detour 1 km Ahead | X | | | | | |
| TC-5B | Detour 2 km Ahead | X | | | | | |
| TC-7 | Detour-Turn Off/Diversion | | X | X | | X | |
| TC-7tA | Road Closed Tab | | X | X | | X | |
| TC-7tB | Local Traffic Only Tab | | X | X | | X | |
| TC-9 | Roadside Diversion Warning | | X | | | | |
| TC-10 | Detour Markers | X | X | | | | |
| TC-11 | Narrow Lanes | | X | | | X | |
| TC-12 | Flashing Arrow Board | | X | X | | | |
| TC-12 | Flashing Arrow Board (Truck Mounted) | | X | X | | X | |
| TC-13 | Pavement Ends | X | X | D | D | X | X |
| TC-14 | Bump Ahead | X | X | D | D | X | X |
| TC-15 | Bump | X | X | D | D | X | X |
| TC-16 | Turn & Curve | X | X | D | D | X | X |
| TC-17t | Advisory Speed Tab | X | X | | | X | X |
| TC-18 | Chevron Alignment | X | X | X | D | X | X |
| TC-19 | Grooved Pavement | X | X | D | D | X | X |
| TC-20 | Prepare to Stop | X | X | | | X | X |
| TC-21 | Traffic Control Person Ahead | | X | | | | |
| TC-22 | Traffic Control (STOP/SLOW) Paddle | | X | | | | |
| TC-23 | Signals Ahead | | X | | | | |
| TC-23A | Remote Control Device Ahead | | X | | | | |

| Sign No. | Sign Name | Advance Warning Area | Approach Area | Transition Area | Longitudinal Buffer Area | Work Area | Termination Area |
|----------------|------------------------------------|-----------------------------------|---------------|-----------------|--------------------------|-----------|------------------|
| TC-24 | Uneven Lanes | X | X | D | D | X | X |
| TC-27 | Do Not Pass When Flashing (mobile) | X | X | X | X | X | X |
| TC-31 | Truck Entrance | | | D | D | X | X |
| TC-32 | Temporary Bridge | X | X | D | D | X | X |
| TC-33 | Low Bridge Ahead | X | X | D | D | X | X |
| TC-34 | Two Way Traffic | X | X | D | D | X | X |
| TC-35 | Ramp Closed Ahead | X | X | D | D | X | X |
| TC-36 | Maximum Speed (advisory) | X | X | | | X | |
| TC-37 | Soft Shoulders | X | X | D | D | X | X |
| TC-39 | No Exit | Used on side roads where no exit | | | | | |
| TC-40 | Pedestrian Direction | May be used off road in all areas | | | | | |
| TC-44 | Do Not Use Radio Transmitter | X | | | | | |
| TC-45 | Resume Use of Radio Transmitter | | | | | | X |
| TC-61 to TC-81 | Guide and Information Signs | X | | | | | |
| Rb-91 | Yield to Oncoming Traffic | | | X | | | |
| Rb-92 | Road Closed | | | | | X | |
| Wb-1A | Yield Ahead | | X | | | | |
| | Portable Variable Message Signs | X | | | | | |

D = Discouraged

Table F Usage of Channelizing Devices, Barricades, and Barriers

| | Device | | | | |
|--|-------------------------------|---|--|-----------------------------|--|
| | Cones** TC-51A (450 mm) | Cones** TC-51B (700 mm) TC-51C (1000 mm) | Construction Markers Flexible Drums (Barrier) TC-52 TC-54 | Barricades TC-53A TC-53B | Temporary Concrete Barriers (TCBs) |
| Zone Painting | VSD, SD | Option | Not required | Not required | Not required |
| Two-lane Roads | No | VSD, SD | LD* | LD | Not required |
| Multi-lane Roads (Non-freeways) | No | VSD, SD | LD* | LD | Not required |
| Freeways | No | VSD, SD (daytime only) | VSD, SD (night-time), LD less than 5 days.*** | LD | LD more than 5 days |

* may also be used for VSD or SD, in place of TC-51B or TC-51C, if space permits.

** all cones require white reflective cone collars.

*** Where space permits, TC-54s should be used on freeways rather than TC-52s.

VSD = Very Short Duration

SD = Short Duration

LD = Long Duration

TCB = Temporary Concrete Barrier

No = Must not be used

Table G Decision Matrix: Typical Layouts

| Roadway and Temporary Condition Configuration | Duration of Work | | | |
|---|------------------|--------|----------------------|--------|
| | Mobile | VSD | SD | Long |
| Two Lane Road | | | | |
| Shoulder work | TL-5 | | TL-6 | |
| Lane encroachment - remaining lane width 3m or greater | TL-7 | | TL-8 | |
| Partial lane shift - remaining lane width less than 3m | | | TL-9 | |
| Partial lane shift - remaining lane width less than 3m - with Parking lane | | | TL-10 | |
| Lane closed or occupied by mobile operations | TL-18 | | | |
| Lane closed - low volume - yield to oncoming traffic | | TL-19 | | |
| Lane closed - Traffic Control Persons (TCPs) | | TL-20A | TL-20A or 20B | TL-20B |
| Lane closed - Automated Flagger Assistance Device (AFAD) | | | TL-20C | |
| Lane closed - Portable Lane Control Signals (PLCS) | | | TL-21 | |
| Detour - roadway diversion | | | TL-40 | |
| Detour - direct to use alternative roads | | | TL-42(i) & TL-42(ii) | |
| Multi-Lane Road - NON Freeway | | | | |
| Shoulder or median work | TL-5 | | TL-6 | |
| Lane encroachment - remaining lane width 3 m or greater | TL-7 | | TL-14 | |
| Lane encroachment - narrow lanes | | | | TL-17 |
| One Lane Closed: | | | | |
| Parking lane closed | | TL-16 | | |
| Right or left lane closed (divided rd), right lane closed (undivided rd) | TL-22 | | TL-23 | |
| Left lane closed on undivided road or where no shoulder | TL-25 | | TL-26 | |
| Centre 2 way left turn lane closed | | TL-30 | | |
| Three-lane road or Passing/Truck Climbing lane present - single lane direction closed | TL-18 | | TL-31 | |
| Three-lane road or Passing/Truck Climbing lane present - two lane direction, right lane closed | TL-22 | | TL-23 | |
| Three-lane road or Passing/Truck Climbing lane present - two lane direction, centre lane closed | TL-25 | | TL-32 | |
| Three through lanes, centre lane closed | | | TL-37 | |
| Two Lanes Closed: | | | | |
| Four-lane road, two through lanes closed (undivided) | | | TL-33 | |
| Three or Five-lane road with centre 2 way turn lane, two through lanes closed | | | TL-35 | |
| Three or Five-lane road, Centre 2 way left-turn lane & left through lane closed | | | TL-36 | |
| Six-lane road, two lanes closed | | | TL-37 | |
| Lane realignment | | | | TL-41 |
| Detour - direct to use alternative roads | | | TL-42(i) & TL-42(ii) | |

| Roadway and Temporary Condition Configuration | Duration of Work | | | |
|---|------------------|-------|-------------|------------------|
| | Mobile | VSD | SD | Long |
| Multi-Lane Road - Freeway | | | | |
| Shoulder or median work | | TL-11 | | TL-12 |
| Lane encroachment - narrow lanes | | | | TL-17 |
| One lane closed - right or left lane with shoulder | TL-27 | TL-28 | | TL-29 |
| One lane closed - three lane direction, centre lane closed | | | | TL-38 |
| Two lanes closed - six-lane road | | | | TL-38 |
| Lane realignment | | | | TL-41 |
| Ramps | | | | |
| Lane closed at exit ramp | | | | TL-43 |
| Lane closed at entrance ramp | | | | TL-44 |
| Ramp closed | | | | TL-45 |
| Intersections | | | | |
| Two Lane Road: | | | | |
| Near-side lane closed (TCP or detour) | | TL-46 | TL-46 or 47 | TL-47 |
| Far-side lane closed (TCP or detour) | | TL-48 | TL-48 or 49 | TL-49 |
| Work in intersection (TCP) | | TL-50 | TL-47 or 50 | TL-47 |
| Multi-Lane Road: | | | | |
| Near-side through lane closed | | | | TL-51 |
| Near-side right-turn lane closed | | | | TL-52 |
| Near-side left-turn lane closed | | | | TL-53 |
| Near-side right-turn lane open and adjacent through lane closed | | | | TL-54 |
| Near-side left-turn lane open and adjacent through lane closed | | | | TL-55 |
| Near-side right-turn lane and adjacent through lane closed | | | | TL-56 |
| Near-side left-turn lane and adjacent through lane closed | | | | TL-57 |
| Work in intersection - right lane closed | | | | TL-58 |
| Work in intersection - left lane closed | | | | TL-59 |
| Work in intersection - two lanes closed | | | | TL-60A or TL-60B |
| Far-side through lane closed | | | | TL-61 |
| Far-side right lane closed, near-side right-turn lane open | | | | TL-62 |
| Far-side left lane closed, near-side left-turn lane open | | | | TL-63 |

| Roadway and Temporary Condition Configuration | Duration of Work | | | | |
|---|------------------|------------------|-------|------|------|
| | Mobile | VSD | SD | Long | |
| Intersections - Roundabouts | | | | | |
| Single Lane Roundabout: | | | | | |
| Encroachment | | TL-85 | | | |
| Lane closed or occupied mobile | TL-18 | | | | |
| Quadrant closed (Traffic Control Person) | | | TL-86 | | |
| Exit closed - detour | | | TL-87 | | |
| Multi-Lane Roundabout: | | | | | |
| Encroachment | | TL-85 | | | |
| Lane closed or occupied mobile | TL-18 | | | | |
| Inside lane closed | | TL-88 | TL-89 | | |
| Outside lane closed | | TL-90 | TL-91 | | |
| Outside lane closed at island or left exit lane closed | | TL-92 | TL-93 | | |
| Exit closed - detour | | | TL-87 | | |
| Type of Activity | | Duration of Work | | | |
| | | Mobile | VSD | SD | Long |
| Designated Construction Zone Signing | | | | | |
| Two lane road | | | | TL-1 | |
| Multi-lane road | | | | TL-2 | |
| Reduced Speed Zone Signing | | | | | |
| Two lane road | | | TL-3 | | |
| Multi-lane road | | | TL-4 | | |
| Pedestrian Accommodation | | | | | |
| Mid-block location -sidewalk detour onto roadway | | | TL-64 | | |
| Approaching Intersection - sidewalk detour onto roadway | | | TL-65 | | |
| Vehicle encroachment onto road/sidewalk | | | TL-66 | | |
| Zone Painting | | | | | |
| Two lane road - non-coning paint | TL-67 | | | | |
| Multi-lane road - non-coning paint | TL-68 | | | | |
| Intersections: | | | | | |
| Turn arrows | | TL-69 | | | |
| Stop-lines and crosswalks | | TL-70 | | | |
| Left lanes closed | | TL-71 | | | |
| Right lanes closed | | TL-72 | | | |

| Type of Activity | Duration of Work | | | |
|--|-----------------------------|-------------------|----------------|------|
| | Mobile | VSD | SD | Long |
| Intermittent work (including pre-engineering and survey operations) | | | | |
| Within R.O.W. - no work on shoulder or in live lane | No Traffic Control Required | | | |
| Within R.O.W., including on shoulder - duration equals continuous or total of intermittent work on shoulder | | | | |
| Two lane road | | TL-5 | TL-6 | |
| Multi-lane non freeway | | TL-5 | TL-6 | |
| Multi-lane freeway | | TL-11 | TL-12 | |
| Within R.O.W., including intermittent momentary work in live lane*- duration equals continuous or total of intermittent work on shoulder | | | | |
| Two lane road | | TL-73B | | |
| Multi-lane non freeway | | TL-76 | | |
| Multi-lane freeway | | TL-28 | TL-29 | |
| Intersections | | TL-74 | | |
| Within R.O.W., including live lane - duration equals continuous or total of intermittent momentary work in live lane* | | | | |
| Two lane road | | TL-19 or TL-20A | | |
| Multi-lane non freeway | | TL-22 or 25 | TL-23 or 26 | |
| Multi-lane freeway | | TL-28 | TL-29 | |
| Intersections | | see intersections | | |
| Setup and Removal | | | | |
| Set up of Freeway Lane Closures | See section 4.2.1 | | | |
| Removal of Freeway Lane Closures | See section 4.2.2 | | | |

*When a technician is intermittently and MOMENTARLY (NOT CONTINUOUSLY) on the travelled lanes of the roadway the Typical Layouts TL-73B, TL-74, TL-76 can ONLY be used if sight lines in both directions exceed 250m where NPRS is greater than 80km/h, 200m where the NPRS is between 60km/h and 80km/h or 150m where the NPRS is 60km/h or less.

8.1 General Notes to Typical Layouts:

NOTE

1. A note in brackets under/beside a sign name or within a box (ie. (NPRS 70km/h or greater) or (Long Duration)) indicates the sign is only required when that criterion is present.
2. The TC-1 and TC-2 are both required for Long Duration operations. The TC-1 is to be installed and remain in place continuously for the duration of the project. The TC-2 is to be in place to indicate workers may be present and also indicates the start of the approach area. Additional TC-2s should be included in each work area within a long work zone that has multiple work areas. For SD only the TC-2 is required.
3. The TC-1A and TC-1B are not always shown on the typical layouts. The TC-1A is required for Long Duration rural or freeway operations. Long Duration Freeway operations also require the TC-1B.
4. A work area, as shown on the TLs, may or may not contain a work vehicle depending on the work activity. A work vehicle may be used as a traffic control device only as shown on the typical layouts. If used as a traffic control device the work vehicle must have 4WF plus 360 Beacon or TC-12 as indicated. Where a work vehicle is present with four way flashers, 360 beacon and/or TC-12 the work vehicle can replace cones/barrels only where indicated in the typical layouts.

A 360 beacon is a device with an amber light source that continually shows the light source through all 360 degrees of the compass, completing a full rotation every 1.5 seconds. If a 360 Beacon is used, the four way flashers are not required to be operated continuously for longer duration work.
5. NPRS refers to the normal posted regulatory speed which is the speed limit under normal conditions, prior to construction or work activities being present.
6. An end taper on shoulder work is optional.
7. Lane encroachment on freeways is not recommended except where necessary for some mobile maintenance activities. For mobile operations use TL-11 maintaining a 3.5m lane width. For stationary operations use TL-28 or TL-17.

NOTE

8. Lane closed means lane closed or occupied.
9. Signs and devices are oriented on the typical layouts in the direction of travel they are intended to provide guidance to.
10. Signs that are shown on the TLs with a 60m off set indicate the sign is to be repeated on the opposite shoulder.
11. The typical layouts are categorized by the geometrics of the roadway (two lane, multilane non freeway, freeway, roundabout, intersection), number and location of closed/occupied lanes, and the duration of work. They are applicable to all types of work operations, including planning, surveying and other pre-engineering activities. The only exceptions are Paving and Painting operations.

Paving operations, although included as mobile operations by MOL, are considered stationary operations for the purpose of traffic control and the appropriate SD or LD typical should be used (not mobile).

Typical Layouts specific to Painting operations are shown in TL-67 to TL-72.

For additional requirements for Freeway Zone Painting and Freeway Paving operations see section 5.5.4 and 5.5.5 of the office edition.

12. As required by OHSA and its regulations, Temporary Concrete Barriers (TCBs) must be used for stationary operations on freeways, to separate workers from traffic, where the duration of the work is longer than five days. Barrier-mounted delineators should be used with TCBs. Where TCBs are not feasible on freeways and a 3.0m minimum lateral clearance from a live lane of traffic cannot be achieved, an LBA plus BV plus LIDG must be used. TCBs should also be considered for use on non-freeways where the duration is longer than five days, to separate workers from traffic or to separate opposing traffic on multi-lane undivided roads.

13. Use of BVs

NOTE

Freeways:

All Buffer Vehicles (BVs) used on freeways must be crash trucks (CTs)

For operations that require five days or less to complete, or where barriers are not feasible, CTs and both an LBA and LIDG are required for stationary operations and one or more CTs are required for mobile operations.

CTs are not required on freeways where a lateral off set of 3.0 m or more exists between the work area and traffic.

CTs are not required for VSD work on freeway shoulders. CTs are required for Mobile operations on freeway shoulders.













Non-Freeways:

BVs are not specifically required on non-freeways under the MOL regulations. If a BV is used on a non-freeway, the appropriate LBA and LIDG should be used for stationary operations.

On multi-lane roads for normal posted regulatory speeds of 70 km/h or higher, a CT is preferred over a blocker truck.

14. Where a TL for VSD is not presented in Table G for a listed Configuration it is not feasible to set-up, do the work, and take down the required devices within 30 minutes therefore the measures for SD work must be used.
15. Approval of the Road Authority is required for use of traffic control devices not shown in OTM Book 7.
16. Typical Layouts in OTM Book 7 meet most common scenarios. For situations not shown in OTM Book 7 or when TLs require modifications to accommodate site specific conditions follow the fundamental principles in Sections 2 and 3 of OTM Book 7 Office Edition.

8.1.1 Legend of Symbols used in the Typical Layouts

| Legend | |
|--|---|
| Symbol | Description |
|  | Traffic Control Devices TC-51, TC-52 or TC-54 |
|  | Sign |
|  | Traffic Control Person (TCP) |
|  | Work Vehicle, Sign Truck, Blocker Truck, or Crash Truck |
|  | Flashing Amber Light |
|  Beacon plus 4WF | Vehicle Four way Flashers and 360° Beacon |
|  | Work Area |
|  | Portable Traffic Control Signal |
|  | Barricades: TC-53A, TC-53B or temporary concrete barrier |
|  | Automated Flagger Assistance Device |
|  | TC-12 Arrow Mode |
|  | TC-12 Bar Mode |

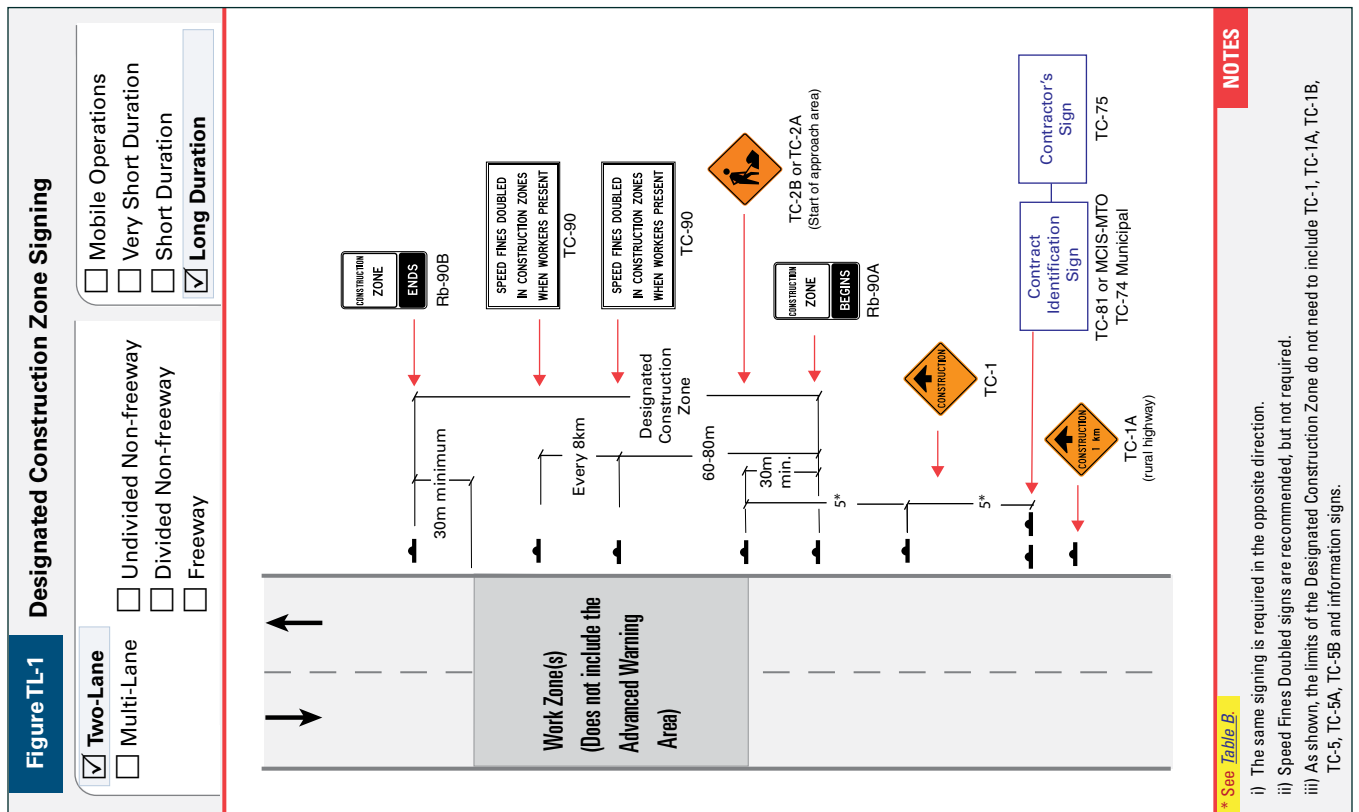

NOTES

* See Table B.

i) The same signing is required in the opposite direction.

ii) Speed Fines Doubled signs are recommended, but not required.

iii) As shown, the limits of the Designated Construction Zone do not need to include TC-1, TC-1A, TC-1B, TC-5, TC-5A, TC-5B and information signs.

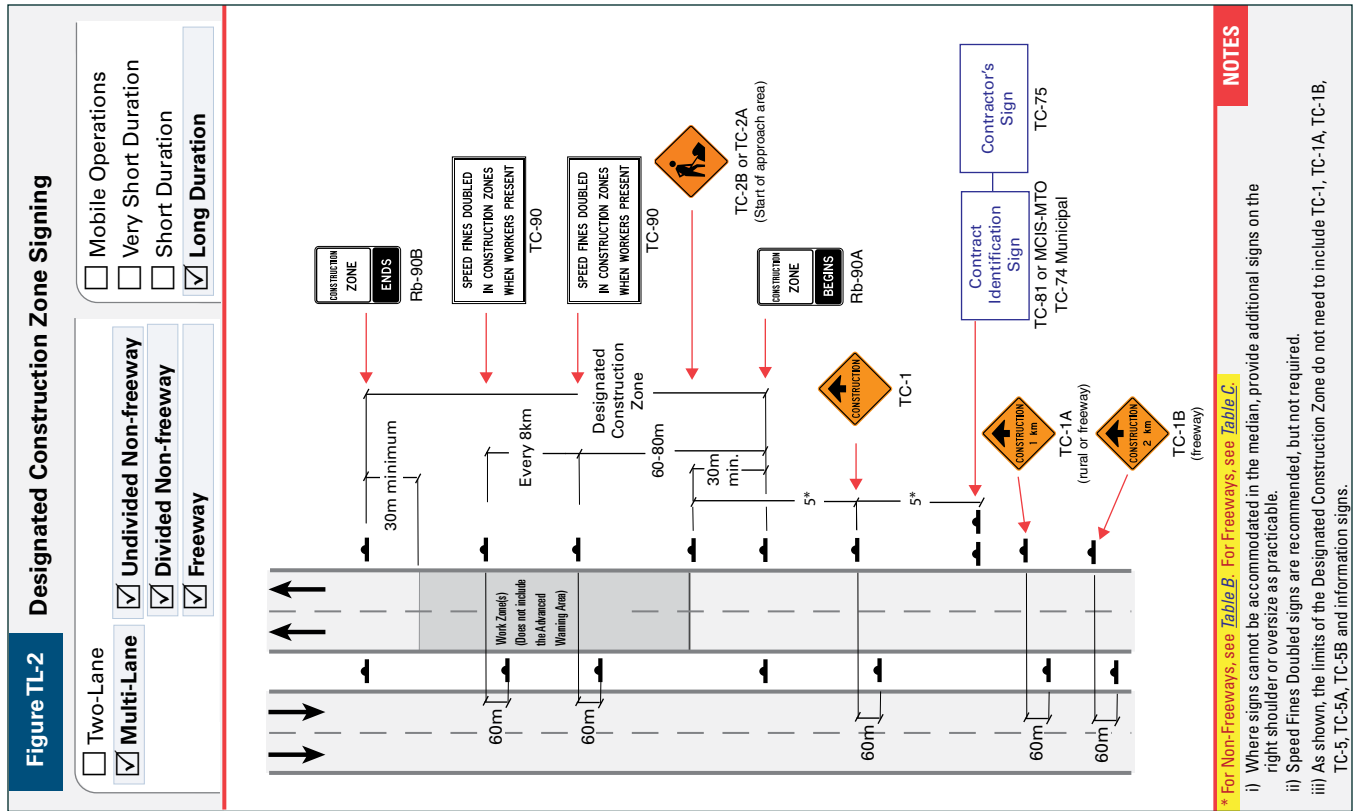

NOTES

* For Non-Freeways, see Table B. For Freeways, see Table C.

i) Where signs cannot be accommodated in the median, provide additional signs on the right shoulder or oversize as practicable.

ii) Speed Fines Doubled signs are recommended, but not required.

iii) As shown, the limits of the Designated Construction Zone do not need to include TC-1, TC-1A, TC-1B, TC-5, TC-5A, TC-5B and information signs.

Figure TL-3 Reduced Speed Zone Signing

Two-Lane
 Multi-Lane
 Undivided Non-freeway
 Divided Non-freeway
 Freeway

Mobile Operations
 Very Short Duration
 Short Duration
 Long Duration

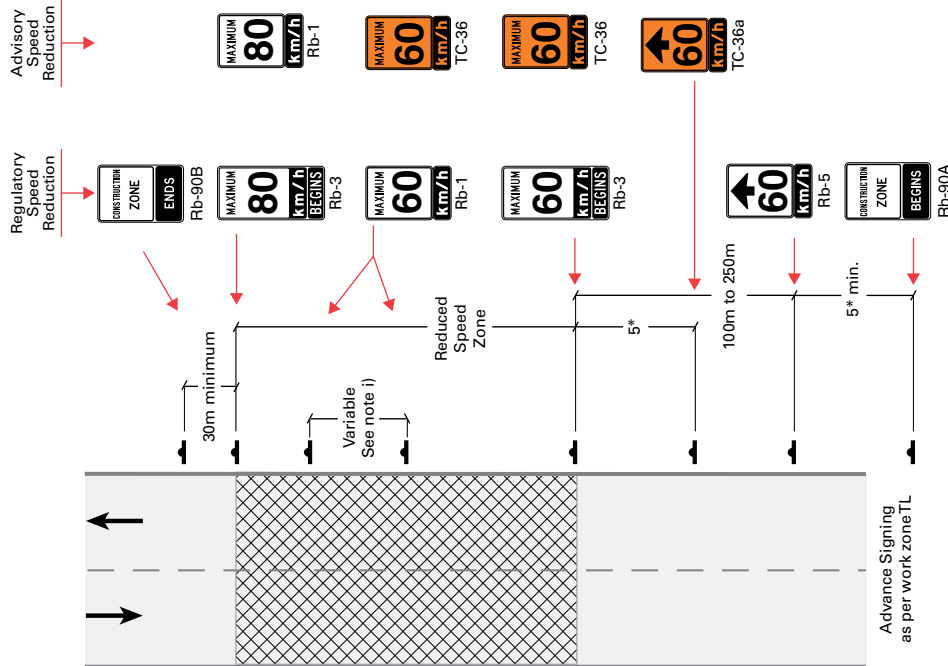

NOTES

* For Short Duration, see [Table A](#). For Long Duration, see [Table B](#).

i) Refer to Regulation 615 of the Highway Traffic Act and OTM Book 5 for distance between regulatory speed limit signs.

ii) For regulatory speed reduction, a Designated Construction Zone must be established and signed as per TL-1.

iii) The same signing is required in the opposite direction.

Figure TL-4 Reduced Speed Zone Signing

Two-Lane
 Multi-Lane
 Undivided Non-freeway
 Divided Non-freeway
 Freeway

Mobile Operations
 Very Short Duration
 Short Duration
 Long Duration

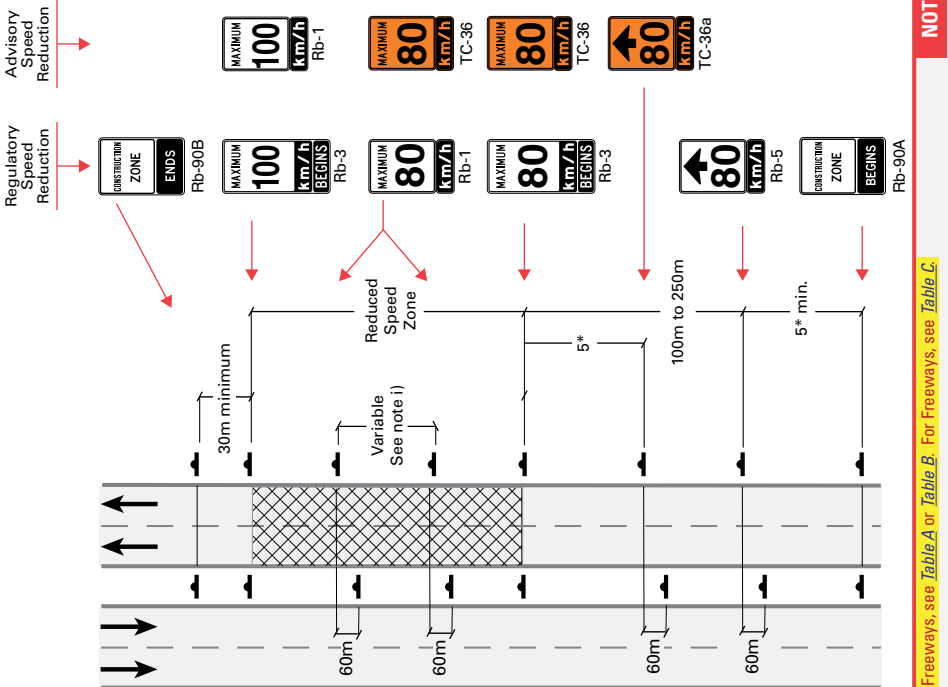

NOTES

* For Non-Freeways, see [Table A](#) or [Table B](#). For Freeways, see [Table C](#).

i) Refer to Regulation 615 of the Highway Traffic Act and OTM Book 5 for distance between regulatory speed limit signs.

ii) For regulatory speed reduction, a Designated Construction Zone must be established and signed as per TL-1.

iii) Where signs cannot be accommodated in the median, provide additional signs on the right shoulder or oversize as practicable.

Figure TL-5 Shoulder Work

Two-Lane
 Multi-Lane

Undivided Non-freeway
 Divided Non-freeway
 Freeway

Mobile Operations
 Very Short Duration
 Short Duration
 Long Duration

With work vehicle - Mobile or VSD

No work vehicle - VSD

NOTES

- i) Work on the left shoulder mirror image for multi-lane divided road.
- ii) Termination taper optional.

* See [Table A](#)

Figure TL-6 Shoulder Work

Two-Lane
 Multi-Lane

Undivided Non-freeway
 Divided Non-freeway
 Freeway

Mobile Operations
 Very Short Duration
 Short Duration
 Long Duration

NOTES

- i) Work on the left shoulder mirror image for multi-lane divided road.
- ii) Termination taper optional.
- iii) Work area may or may not contain a work vehicle. See General Notes to Typical Layouts #4.
- iv) A work vehicle with a TC-12 may replace cones for Short Duration work.

* For Short Duration, see [Table A](#). For Long Duration, see [Table B](#).

Figure TL-7

Lane Encroachment

Two-Lane
 Multi-Lane
 Undivided Non-freeway
 Divided Non-freeway
 Freeway

Mobile Operations
 Very Short Duration
 Short Duration
 Long Duration

With work vehicle - Mobile or VSD

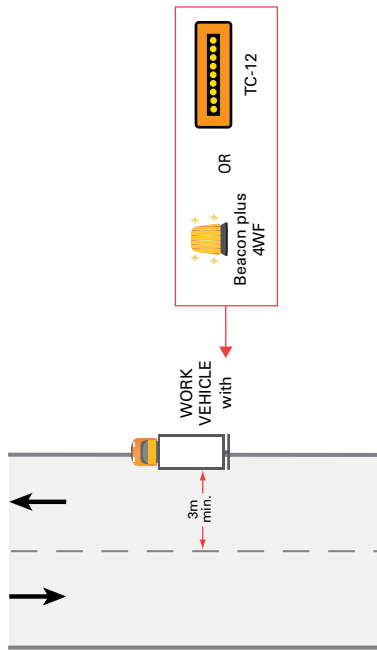

No work vehicle - VSD

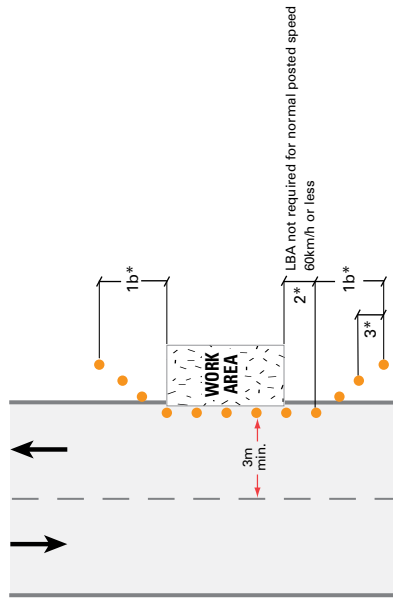

* See Table A

- i) Termination taper optional.
- ii) Encroachment in the left lane, mirror image for multi-lane divided road.

NOTES

Figure TL-8

Lane Encroachment

Two-Lane
 Multi-Lane
 Undivided Non-freeway
 Divided Non-freeway
 Freeway

Mobile Operations
 Very Short Duration
 Short Duration
 Long Duration

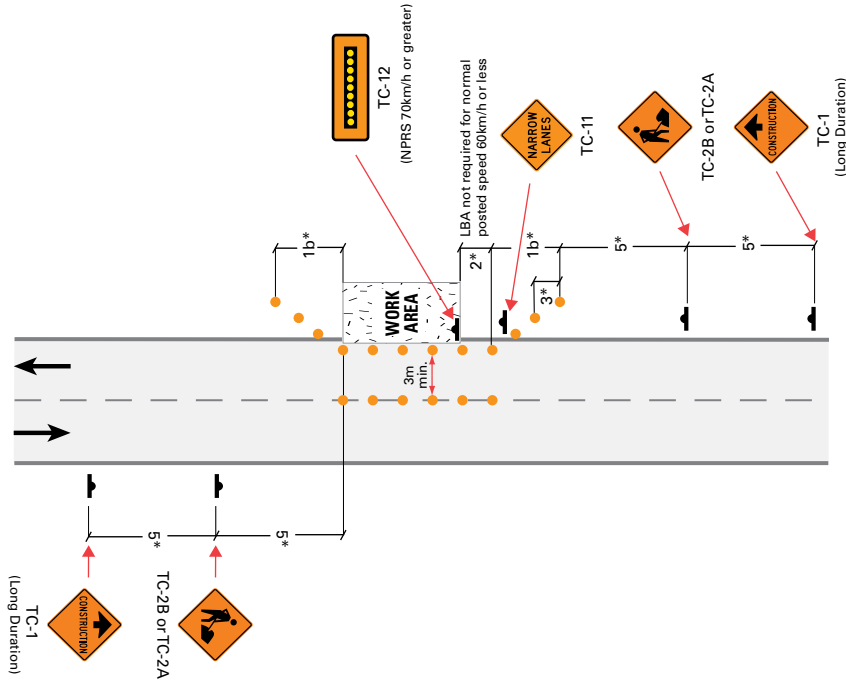

* For Short Duration, see Table A. For Long Duration, see Table B.

- i) If Available Lane Width (ALW) is less than 3m, use partial lane shift (See TL-9, TL-10) or lane closures (TL-20A, TL-20B, TL-21).
- ii) Center line cones are optional and are to be used if lane keeping is an issue.
- iii) On unpaved roads with low volume (<3000 vehicles per day):
 - Where remaining roadway width is at least 6m, and ALW is less than 3m, use Rb-91, a distance 5* upstream of start of taper, and move the TC-1 and TC-2B an additional distance 5* upstream.
- iv) Work area may or may not contain a work vehicle. See General Notes to Typical Layouts #4.
- v) A work vehicle with a TC-12 may replace cones for Short-Duration work where NPRS is under 70km/h.

NOTES

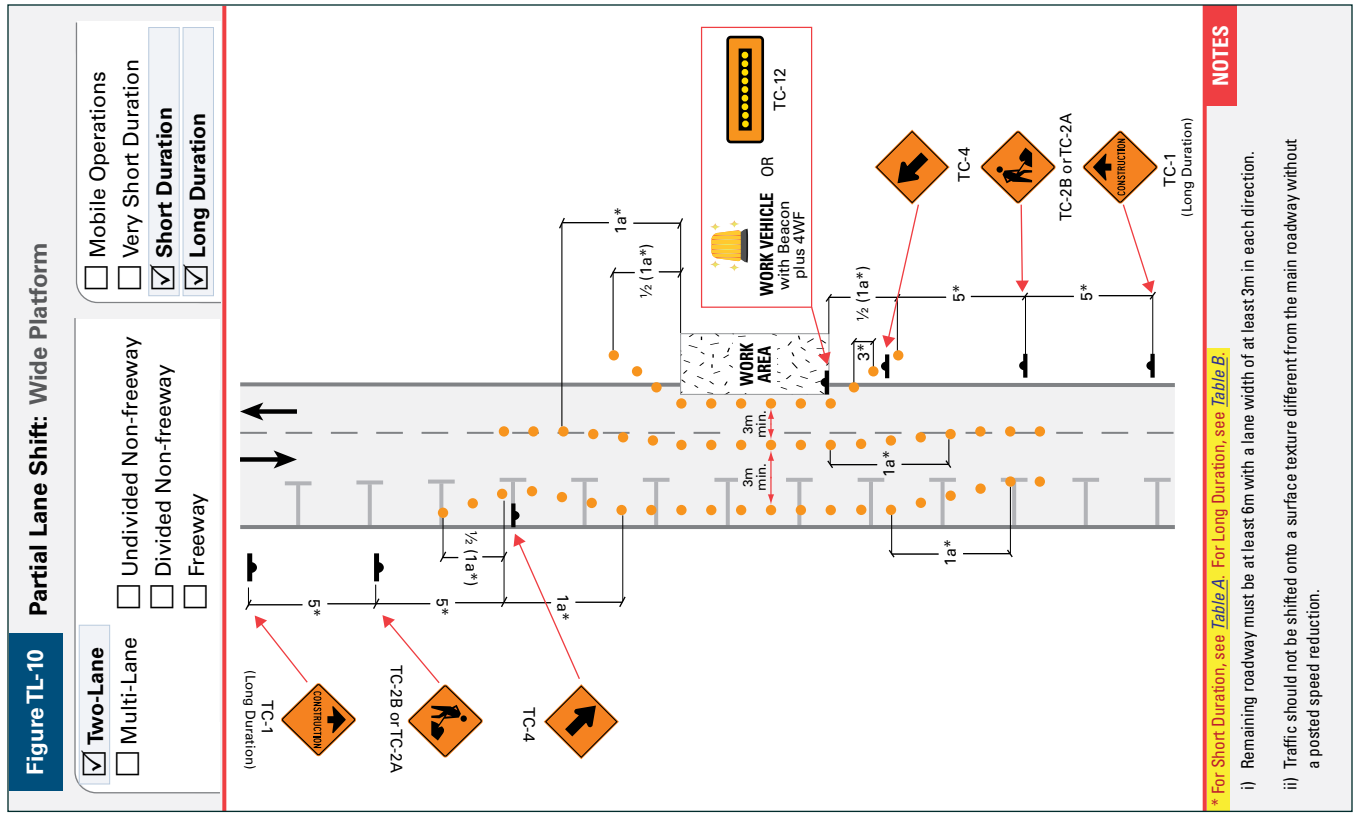
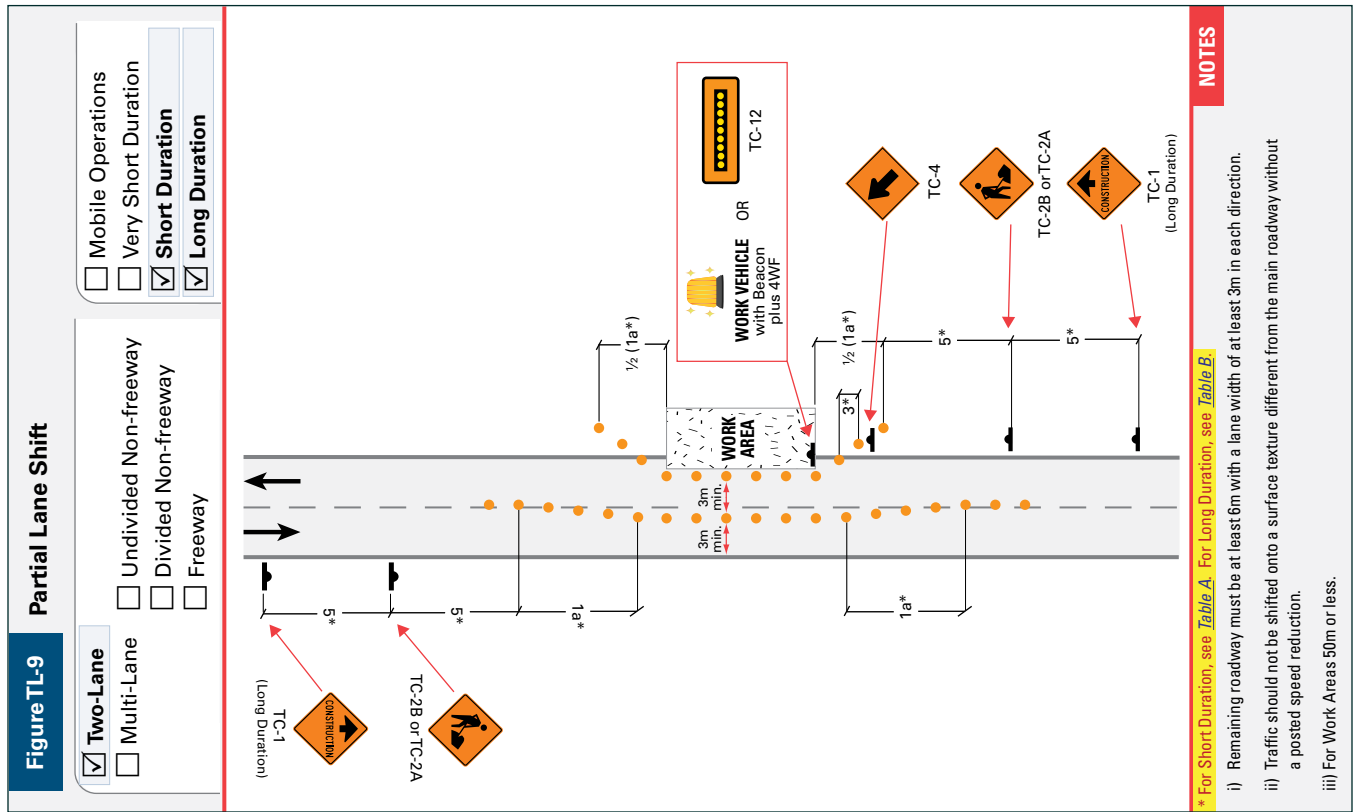
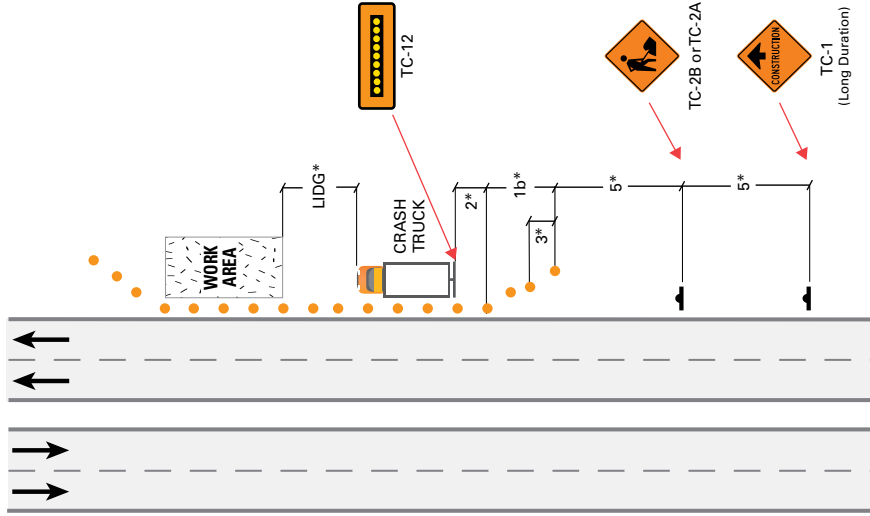

Figure TL-12 Shoulder Work

Two-Lane
 Multi-Lane
 Undivided Non-freeway
 Divided Non-freeway
 Freeway

Mobile Operations
 Very Short Duration
 Short Duration
 Long Duration



* See Table C. For LIDG*, see Table D.

- i) Work on the left shoulder mirror image.

NOTES

Figure TL-11 Shoulder Work

Two-Lane
 Multi-Lane
 Undivided Non-freeway
 Divided Non-freeway
 Freeway

Mobile Operations
 Very Short Duration
 Short Duration
 Long Duration

With work vehicle - Mobile or VSD

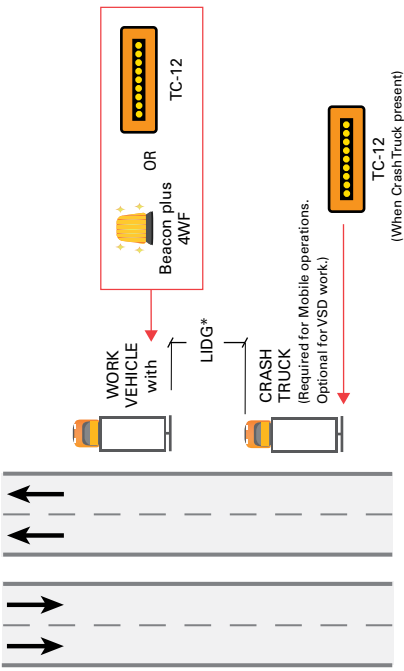

No work vehicle - VSD

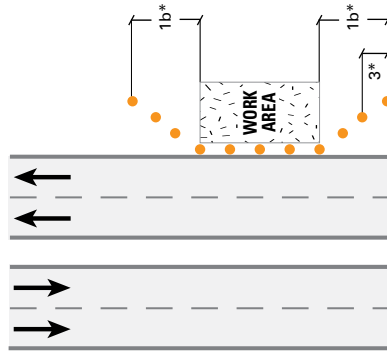

* See Table C. For LIDG*, see Table D.

- i) Work on the left shoulder mirror image.
- ii) Termination taper optional.
- iii) Preferred option for VSD work is to have a work vehicle present..

NOTES

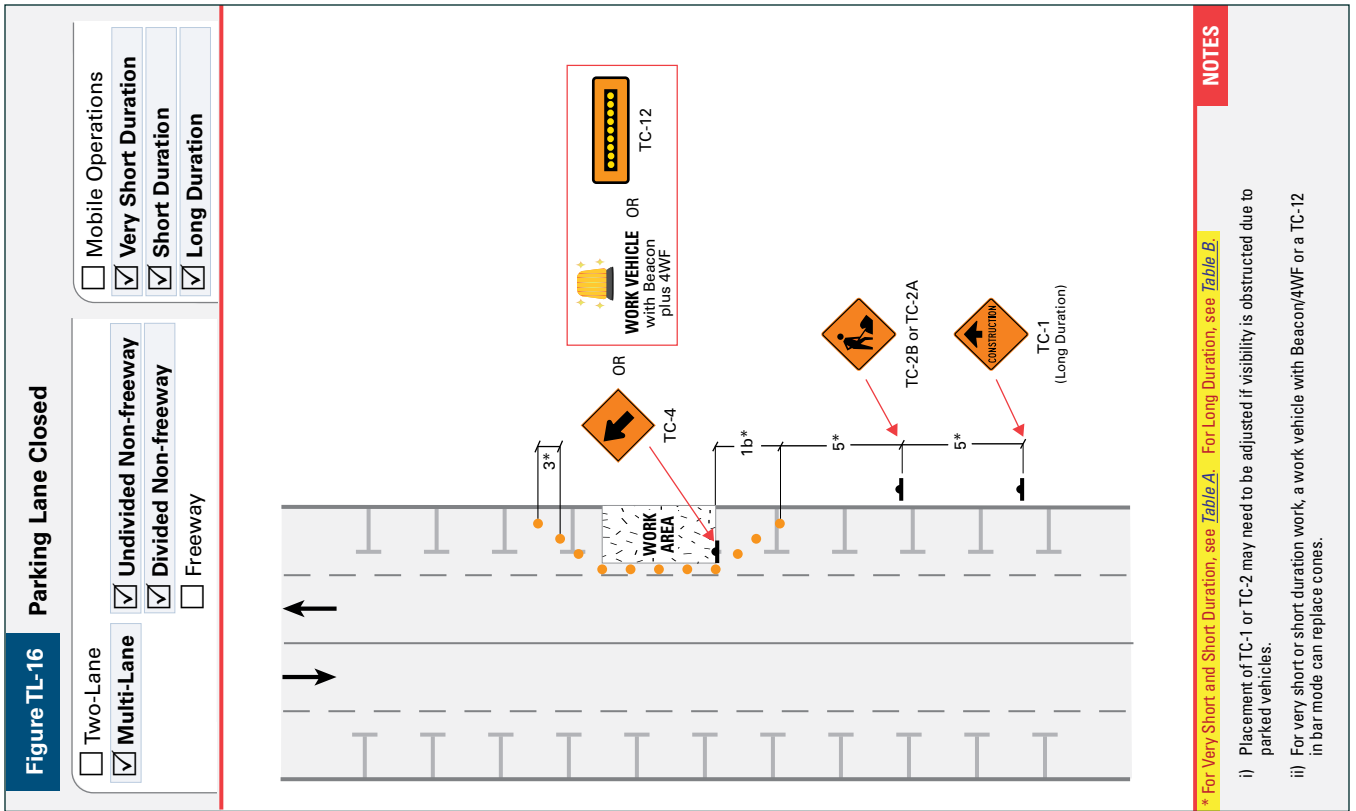
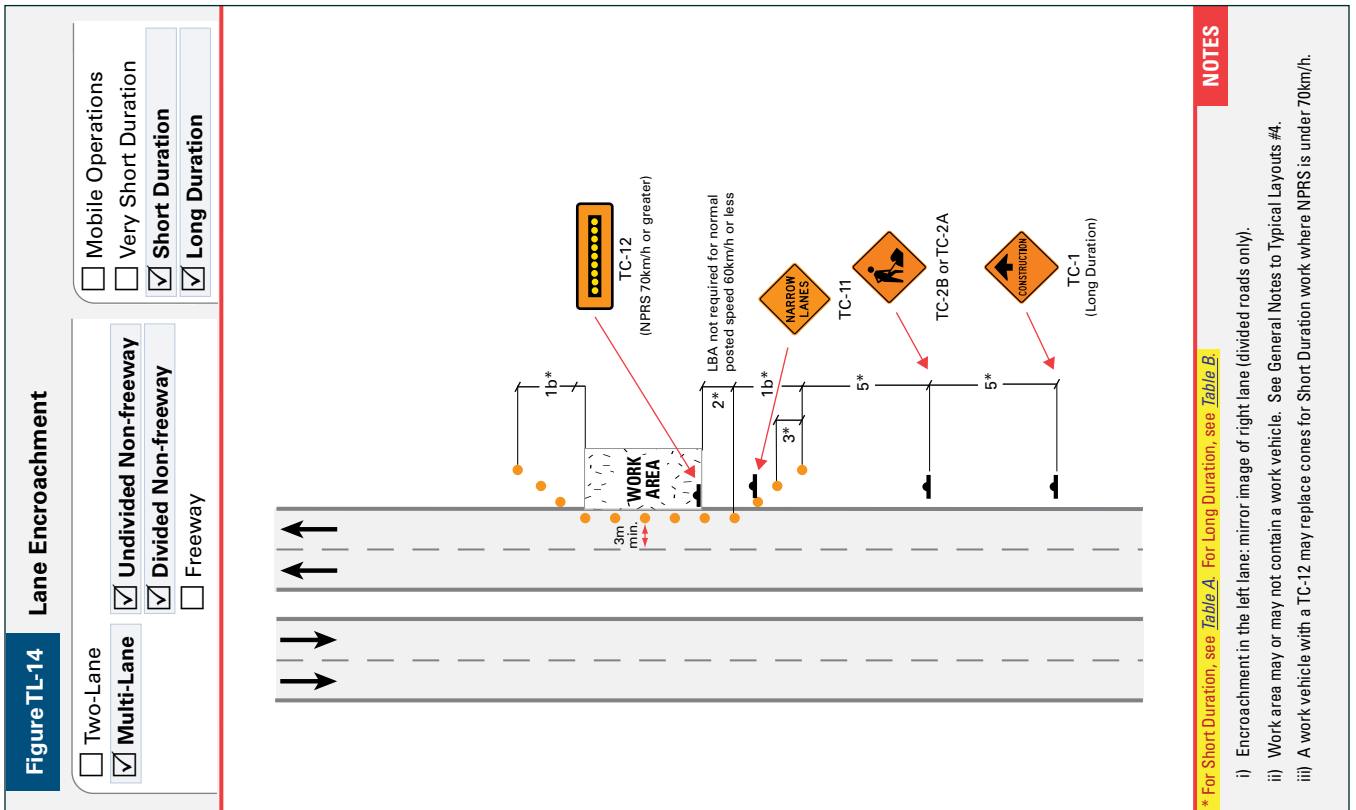

NOTES

* For Short Duration, see Table A. For Long Duration, see Table B.

i) Encroachment in the left lane: mirror image of right lane (divided roads only).

ii) Work area may or may not contain a work vehicle. See General Notes to Typical Layouts #4.

iii) A work vehicle with a TC-12 may replace cones for Short Duration work where NPRS is under 70km/h.

NOTES

* For Very Short and Short Duration, see Table A. For Long Duration, see Table B.

i) Placement of TC-1 or TC-2 may need to be adjusted if visibility is obstructed due to parked vehicles.

ii) For very short or short duration work, a work vehicle with Beacon4WF or a TC-12 in bar mode can replace cones.

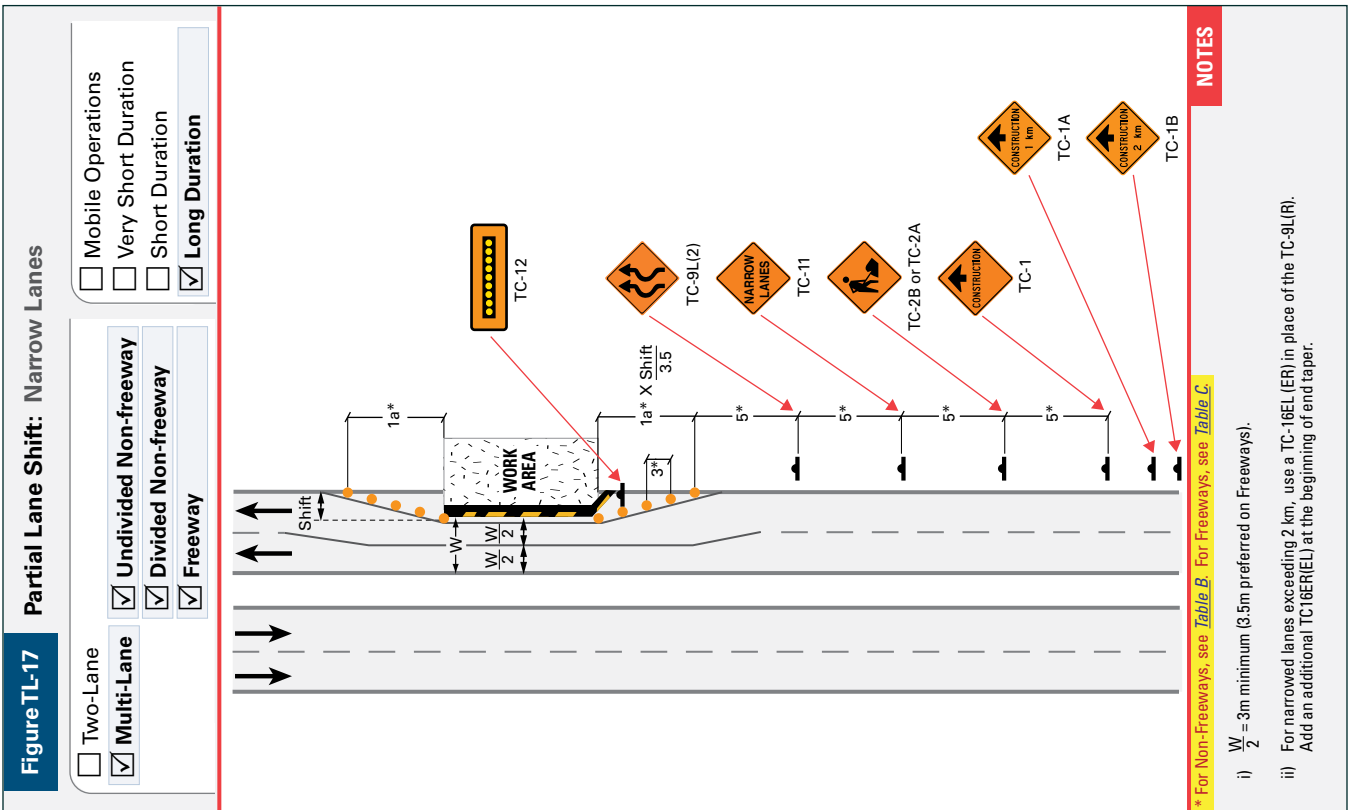
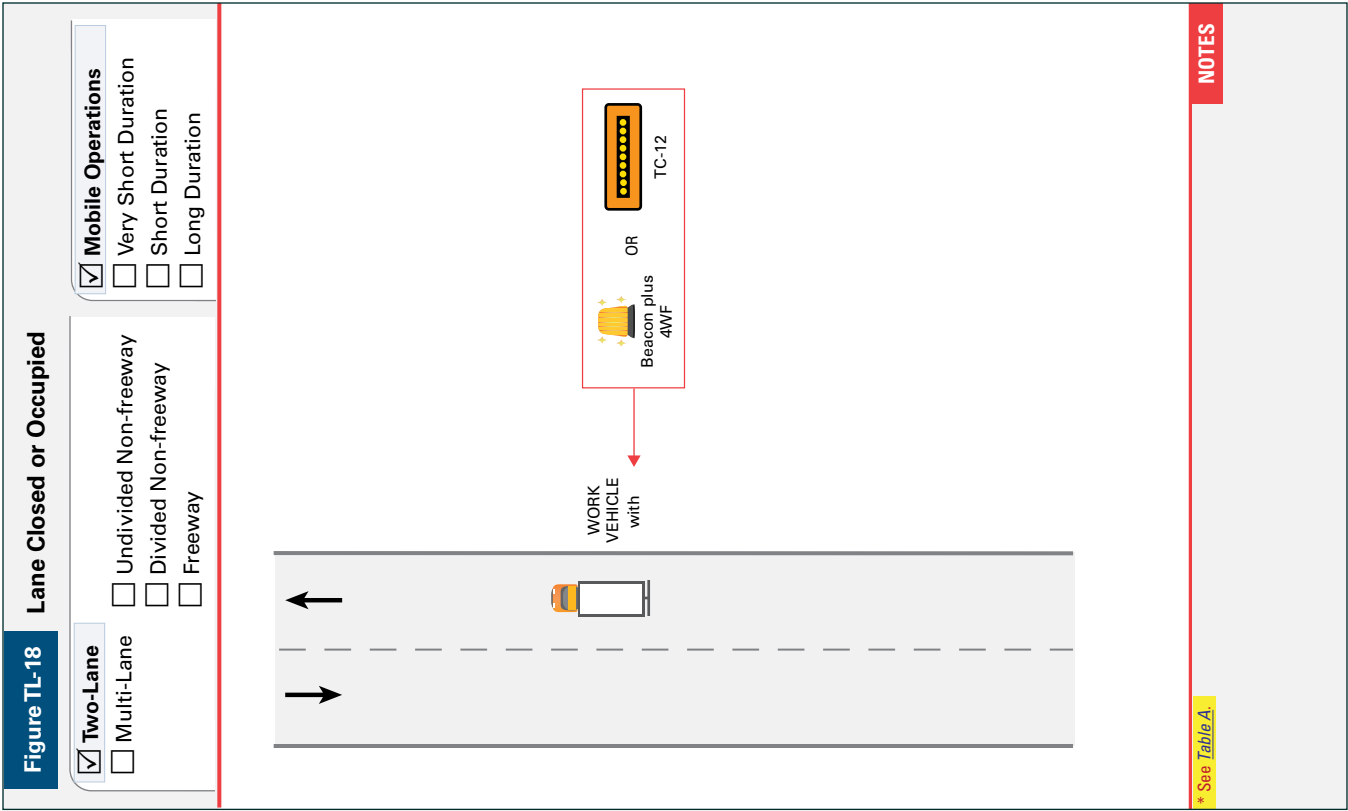
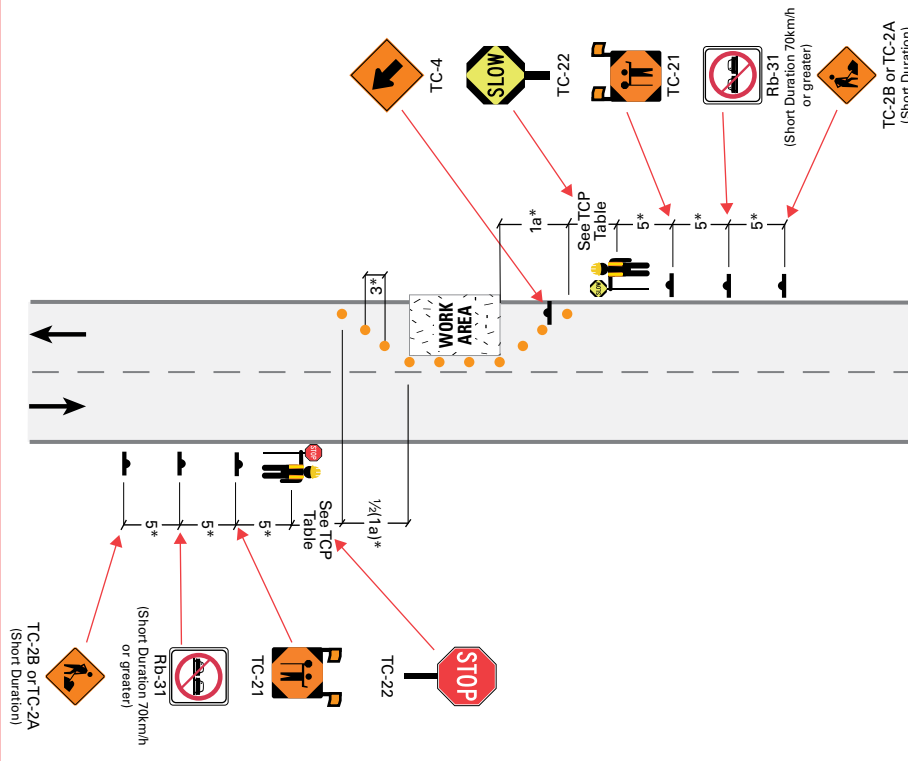

Figure TL-20A Lane Closed (Traffic Control Persons)

Two-Lane **Multi-Lane** **Mobile Operations**

Undivided Non-freeway **Divided Non-freeway** **Freeway**

Very Short Duration **Short Duration** **Long Duration**



NOTES

- i) For low-volume roads (< 3000 vehicles per day) and visibility more than 150m beyond the end taper, the TCP and TC-21 may be eliminated for the direction that is not closed.
- ii) For Very Short duration, work on low-volume roads with a normal posted speed less than 70km/h, the cones are not required.
- iii) On high speed (70 km/h or greater) or where lane keeping/compliance is an issue, consider using TL-20B.

* See Table A.

Figure TL-19 Lane Closed (Yield to Oncoming Traffic)

Low Volume Roads

Two-Lane **Multi-Lane** **Mobile Operations**

Undivided Non-freeway **Divided Non-freeway** **Freeway**

Very Short Duration **Short Duration** **Long Duration**

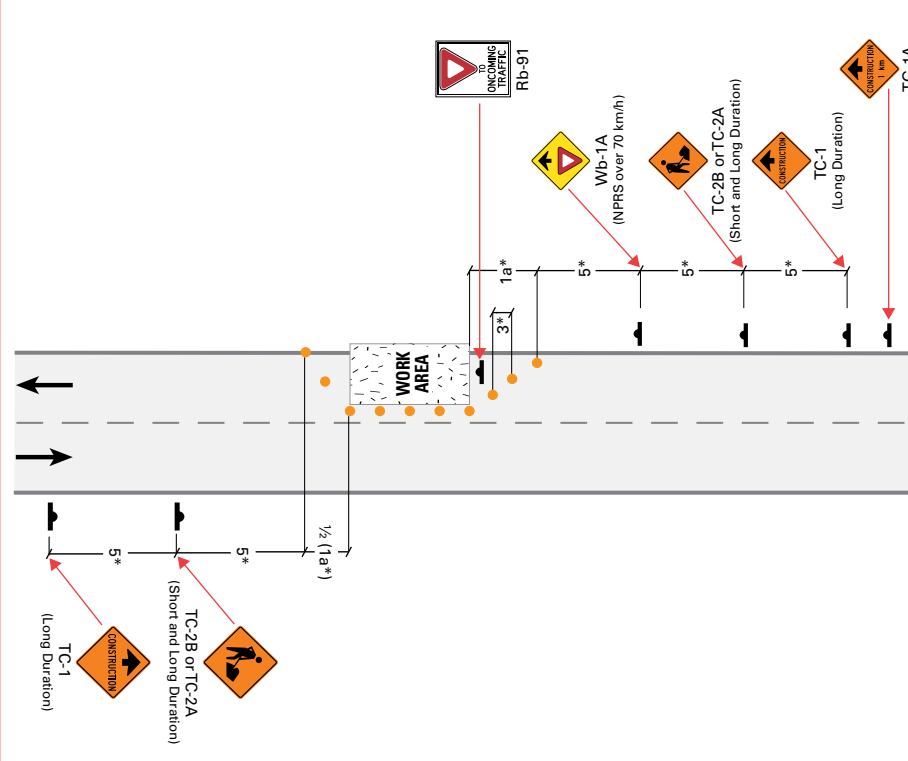

NOTES

- i) Use only on roads with low traffic volume (< 3000 vehicles per day).
- ii) To be used for short length work areas (< 150m).
- iii) May also be used on roads with no centreline.
- iv) Use only where there is unobstructed visibility of oncoming traffic in both directions.
- v) Work area may or may not contain a work vehicle. See General Notes to Typical Layouts #4. If work vehicle has a TC-12, it must be in bar mode.

* For Very Short and Short Duration, see Table A. For Long Duration, see Table B.

Figure TL-208 Lane Closed (Traffic Control Persons)

Two-Lane
 Multi-Lane
 Undivided Non-freeway
 Divided Non-freeway
 Freeway

Mobile Operations
 Very Short Duration
 Short Duration
 Long Duration

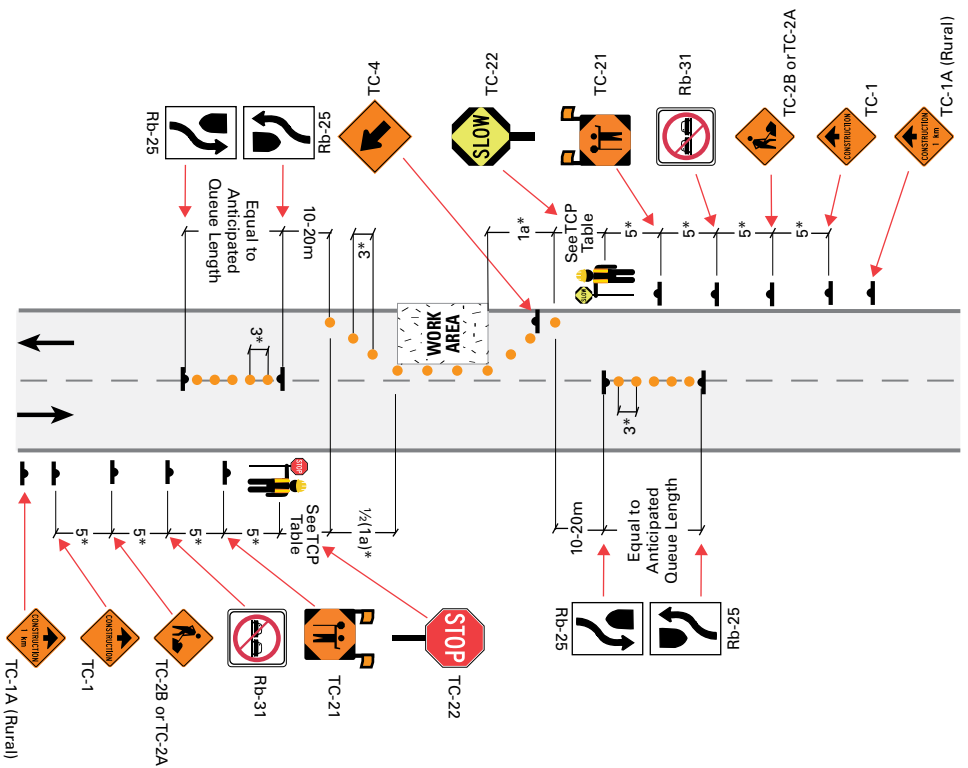

NOTES

* See [Table B](#).

i) For low-volume roads (<3000 vehicles per day) and visibility more than 150m beyond the end taper, the TCP and TC-21 may be eliminated for the direction that is not closed.

ii) Centreline cones between RB-25 signs and RB-25 signs are optional and may be used in one or both directions if lane keeping becomes an issue.

Figure TL-20C Lane Closed (Automated Flagger Assistance Device)

Two-Lane
 Multi-Lane
 Undivided Non-freeway
 Divided Non-freeway
 Freeway

Mobile Operations
 Very Short Duration
 Short Duration
 Long Duration

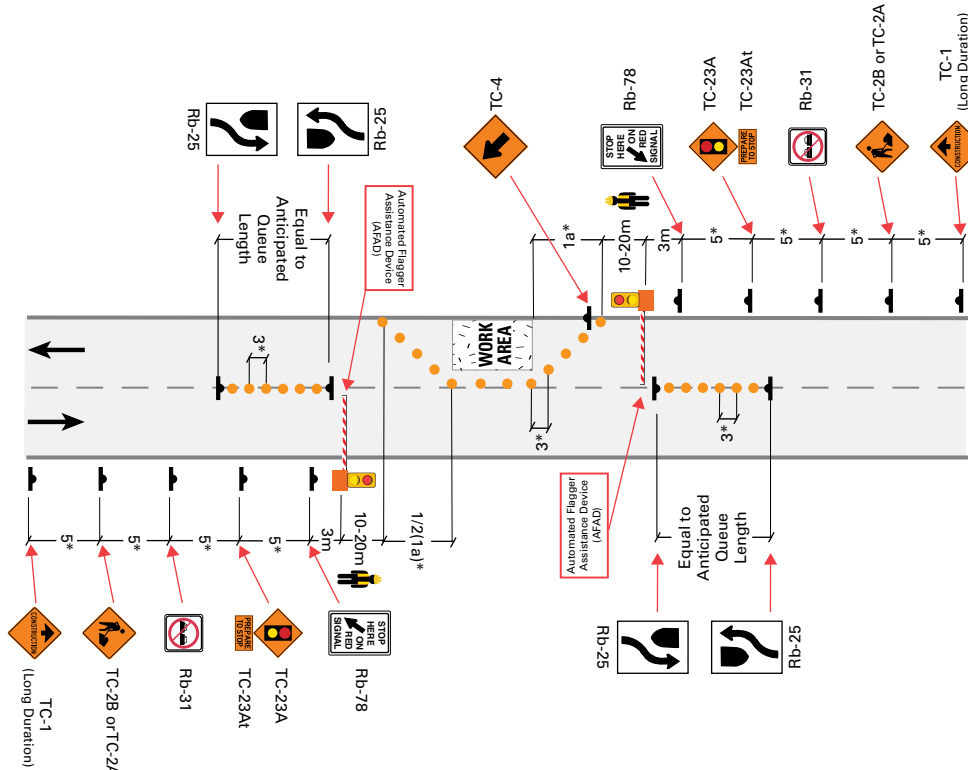

NOTES

* For Short Duration, see [Table A](#). For Long Duration, see [Table B](#).

i) TCP is required to control Automated Flagger Assistance Device and to have a paddle (TC-22) available in the event of failure.

Figure TL-22 Lane Closed or Occupied

Two-Lane

Multi-Lane

Undivided Non-freeway

Divided Non-freeway

Freeway

Mobile Operations

Very Short Duration

Short Duration

Long Duration

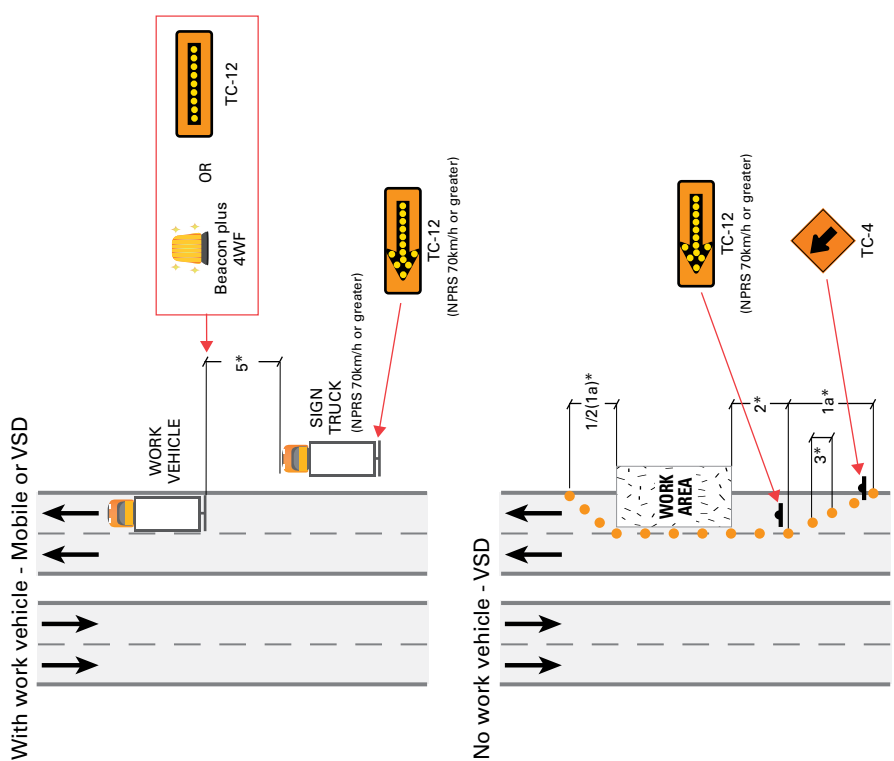

*** See Table A.**

NOTES

- i) Distance between sign truck and work vehicle may be adjusted to accommodate hills, curves, restricted visibility, or other site specific conditions.
- ii) Left lane closed mirror image on divided roads only. Undivided or no shoulder see TL-25.

Figure TL-21 Lane Closed (Portable Lane Control Signals)

Two-Lane

Multi-Lane

Undivided Non-freeway

Divided Non-freeway

Freeway

Mobile Operations

Very Short Duration

Short Duration

Long Duration

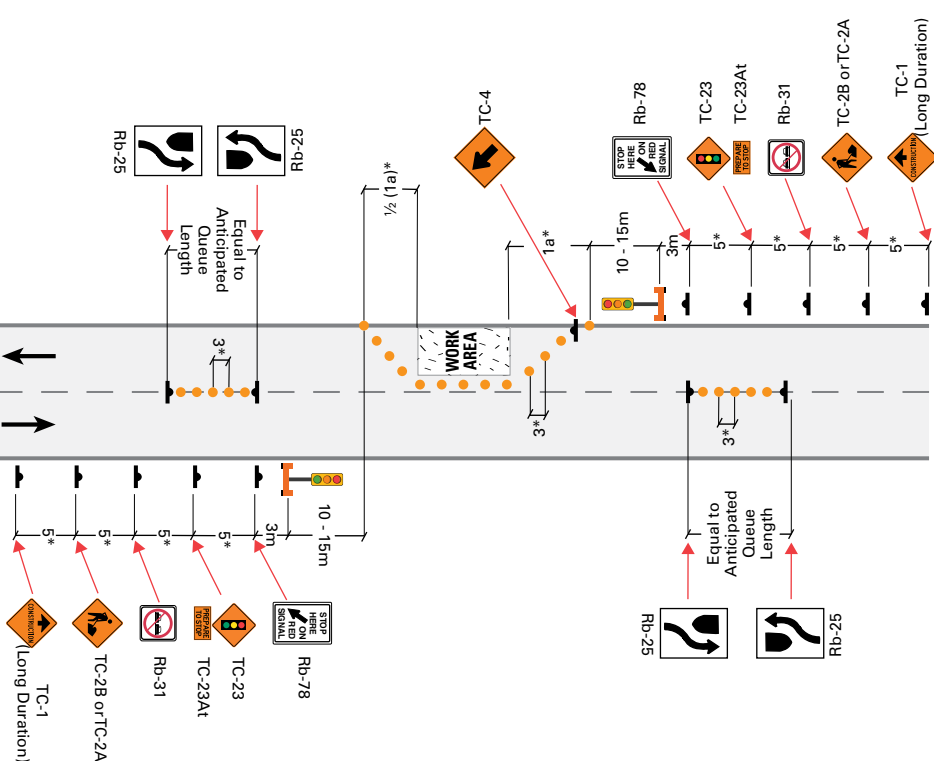

*** See Table A.**

NOTES

- i) To determine the appropriate timing of the lane control signals, see Section 5.3.2 (Office Edition).
- ii) Lane control signals are only to be used while the contractor is on site and on roads with NPRS of 60km/h or less. Portable signals that are to operate when no contractor is present or on roads with a NPRS of 70km/h or greater are Portable Temporary Traffic Control signals (PTTS) and require Road Authority approval of layout and signal timing. MTO applications require the completion of a PHM-125 (see OTM Book 12).

Figure TL-25 Left Lane Closed or Occupied - Undivided or No Shoulder

| | |
|---|---|
| <input type="checkbox"/> Two-Lane | <input checked="" type="checkbox"/> Mobile Operations |
| <input checked="" type="checkbox"/> Multi-Lane | <input checked="" type="checkbox"/> Very Short Duration |
| <input checked="" type="checkbox"/> Undivided Non-freeway | <input type="checkbox"/> Short Duration |
| <input checked="" type="checkbox"/> Divided Non-freeway | <input type="checkbox"/> Long Duration |
| <input type="checkbox"/> Freeway | |

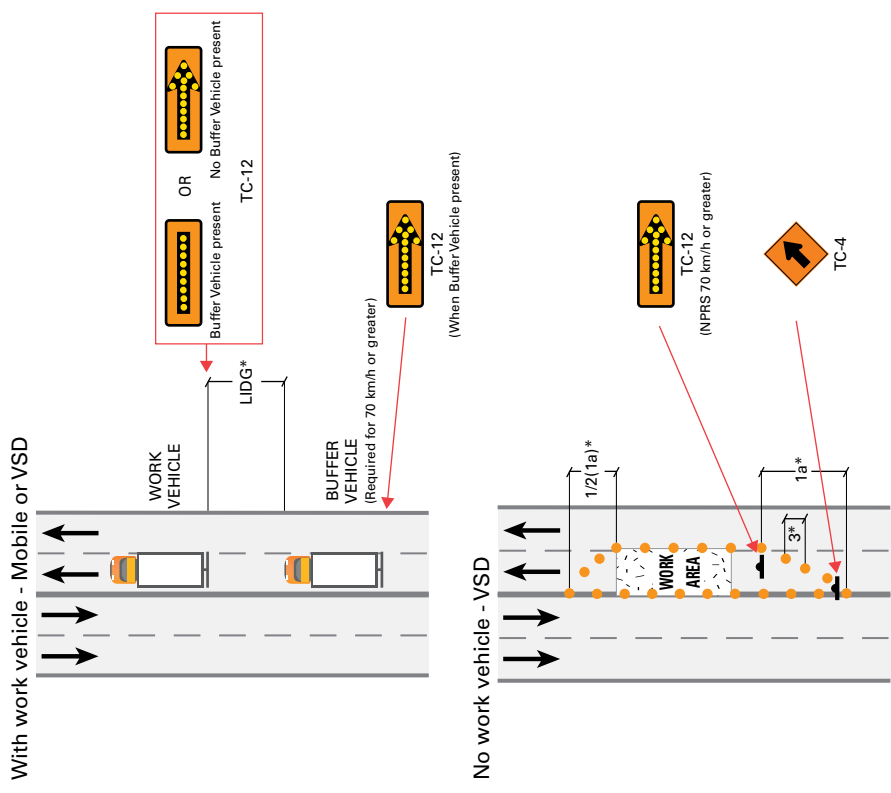

NOTES

* See Table A. For LIDG*, see Table D.

i) Distance between sign truck and work vehicle may be adjusted to accommodate hills, curves, restricted visibility, or other site specific conditions.

ii) Centreline delineation is not required on divided roads.

Figure TL-23 Lane Closed

| | |
|---|--|
| <input type="checkbox"/> Two-Lane | <input type="checkbox"/> Mobile Operations |
| <input checked="" type="checkbox"/> Multi-Lane | <input type="checkbox"/> Very Short Duration |
| <input checked="" type="checkbox"/> Undivided Non-freeway | <input checked="" type="checkbox"/> Short Duration |
| <input checked="" type="checkbox"/> Divided Non-freeway | <input checked="" type="checkbox"/> Long Duration |
| <input type="checkbox"/> Freeway | |

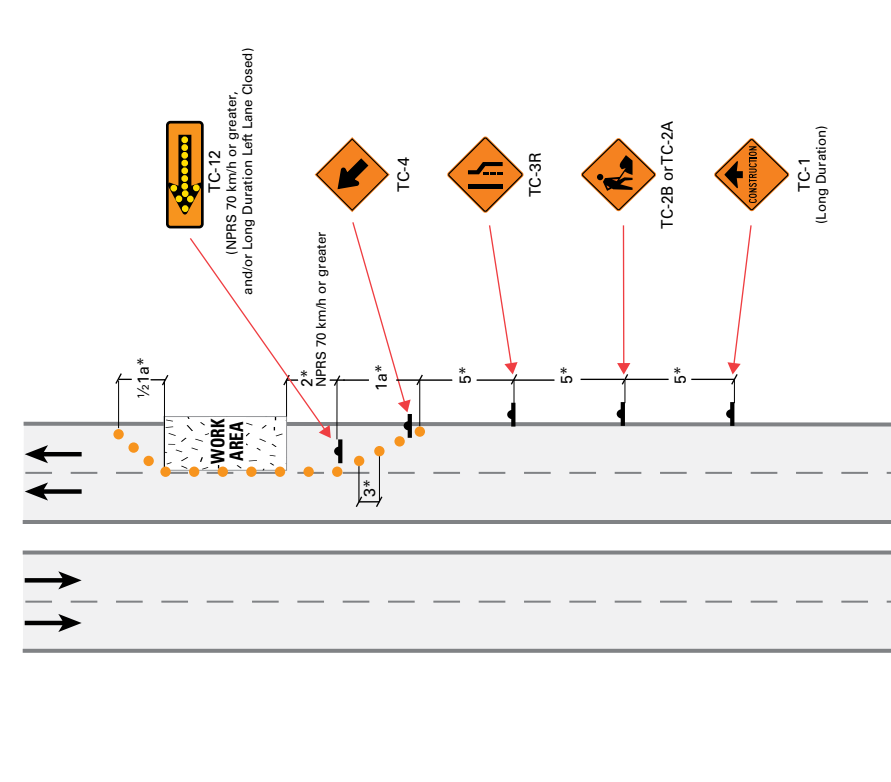

NOTES

* For Short Duration, see Table A. For Long Duration, see Table B.

i) Left Lane Closed: mirror image for divided roads only. For Left lane closed, TC-3R, TC2A or A, TC-1 are to be repeated on opposite shoulder where NPRS is 70km/h or greater.

ii) For Left Lane Closed Undivided or with no shoulder, see TL-26.

Figure TL-27 Right or Left Lane Closed or Occupied

Two-Lane
 Multi-Lane
 Undivided Non-freeway
 Divided Non-freeway
 Freeway

Mobile Operations
 Very Short Duration
 Short Duration
 Long Duration

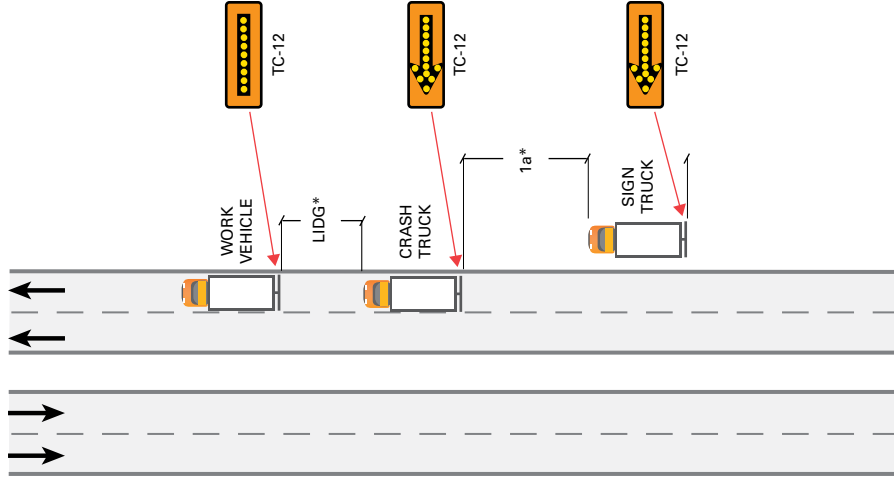

NOTES

- i) For Freeways, see *Table C*. For LIDG*, see *Table D*.
- ii) Distance between Sign Truck and Crash Truck may be adjusted to accommodate hills, curves, restricted visibility, or other site specific conditions.
- iii) Left Lane Closed: mirror image of Right Lane Closed, where shoulder exists. Where no shoulder exists, Sign Truck may be eliminated and the TC-12 on the Work Vehicle should be in arrow mode. Optionally a Crash Truck with TC-12 in a arrow mode can replace the Sign Truck and follow in the occupied lane.

Figure TL-26 Left Lane Closed - Undivided or No Shoulder

Two-Lane
 Multi-Lane
 Undivided Non-freeway
 Divided Non-freeway
 Freeway

Mobile Operations
 Very Short Duration
 Short Duration
 Long Duration

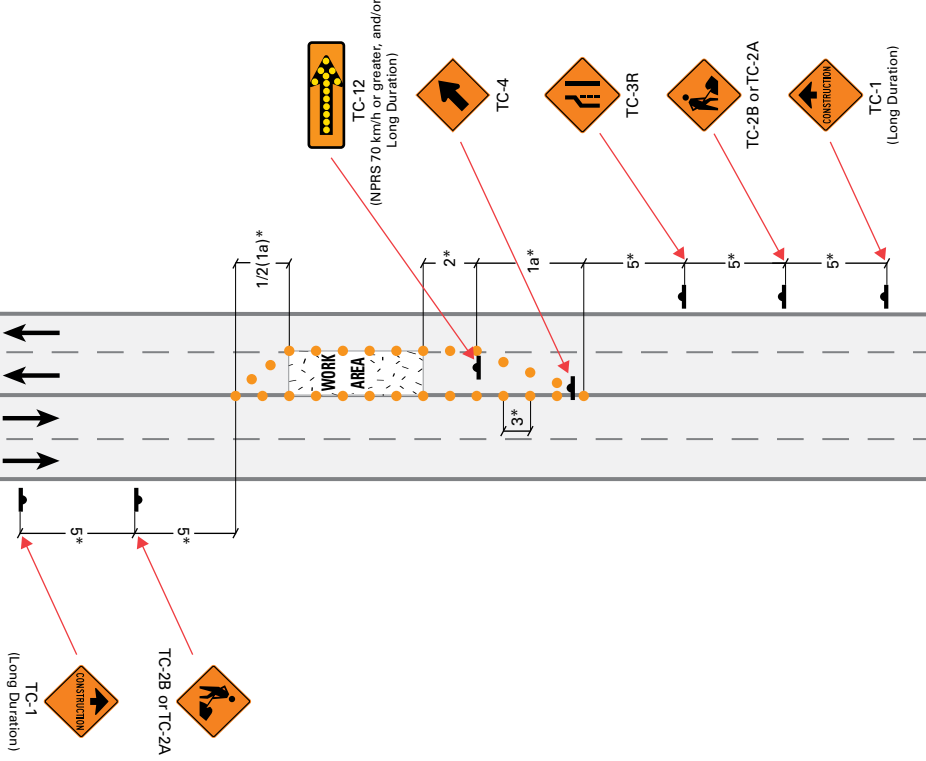

NOTES

- i) For Short Duration, see *Table A*. For Long Duration, see *Table B*.
- ii) Centreline delineation and advance warning signs on opposite direction (TC-1 & TC-2) are not required on divided roads.

Figure TL-28 Right or Left Lane Closed

Two-Lane
 Multi-Lane
 Undivided Non-freeway
 Divided Non-freeway
 Freeway

Mobile Operations
 Very Short Duration
 Short Duration
 Long Duration

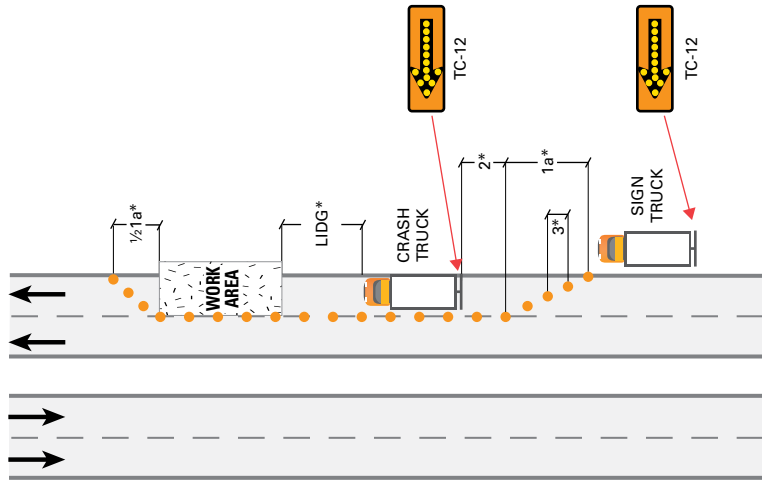

* For Freeways, see [Table C](#). For LIDG*, see [Table D](#).

NOTES

- i) The Work Area may include work vehicles. All work vehicles in the Work Area (downstream of the Crash Truck) with an activated TC-12 must have the TC-12 in bar mode.
- ii) Left Lane Closed: mirror image of Right Lane Closed.
- iii) For HOV lane closure (or other legally limited lane use): lengthen 2* such that the transition taper is within the legal access/egress zone, and lengthen Work Area such that exit taper is within legal access/egress zone. Where not practicable, notify and/or have police present.

Figure TL-29 Right or Left Lane Closed

Two-Lane
 Multi-Lane
 Undivided Non-freeway
 Divided Non-freeway
 Freeway

Mobile Operations
 Very Short Duration
 Short Duration
 Long Duration

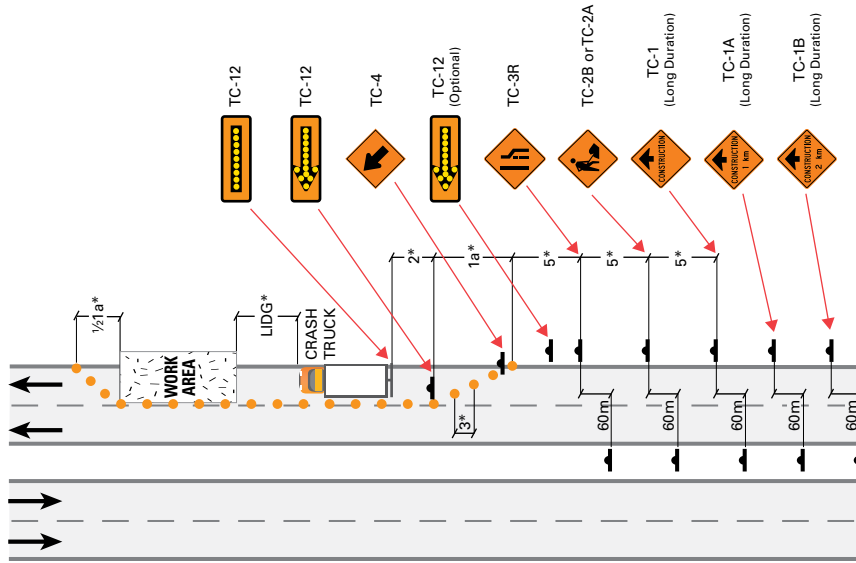

* For Freeways, see [Table C](#). For LIDG*, see [Table D](#).

NOTES

- i) Left Lane Closed: mirror image of Right Lane Closed.
- ii) Where signs cannot be accommodated in the median, provide additional signs on the right shoulder.
- iii) The Work Area may include work vehicles. All work vehicles in the Work Area (downstream of the Crash Truck) with an activated TC-12 must have the TC-12 in bar mode.
- iv) For HOV lane closure (or other legally limited lane use): lengthen 2* such that the transition taper is within the legal access/egress zone, and lengthen Work Area such that exit taper is within legal access/egress zone. Where not practicable, notify and/or have police present.

Figure TL-31 Passing Lanes: Single-Lane Direction Closed

Two-Lane
 Multi-Lane
 Mobile Operations
 Very Short Duration
 Short Duration
 Long Duration

Undivided Non-freeway
 Divided Non-freeway
 Freeway

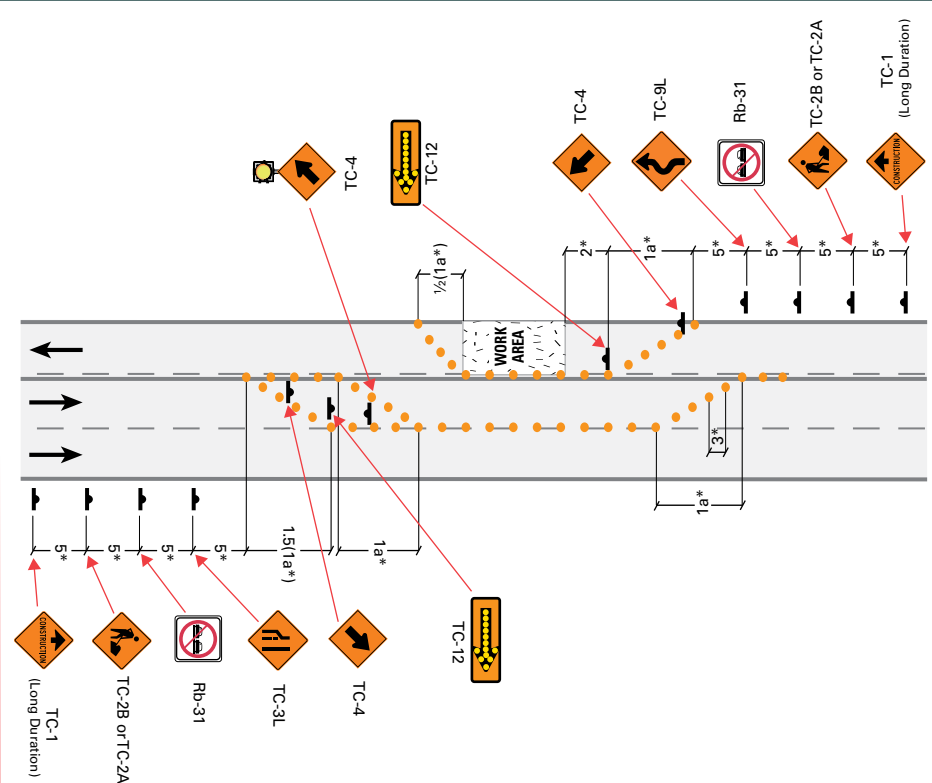

- NOTES**
- * For Short Duration, see [Table A](#). For Long Duration, see [Table B](#).
 - i) The added lane should be allowed to redevelop only if there is sufficient remaining lane length to permit safe passing.
 - ii) For high volume roads or Long Duration work longer than 5 days, the use of Temporary Concrete Barriers should be considered to separate opposing traffic.
 - iii) For Divisions exceeding 1km, use a TC-16(ELER) in place of the TC-9(L), and add an additional TC-16(ER) at the beginning of end taper.

Figure TL-30 Two-Way Left Turn Lane Closed

Two-Lane
 Multi-Lane
 Mobile Operations
 Very Short Duration
 Short Duration
 Long Duration

Undivided Non-freeway
 Divided Non-freeway
 Freeway

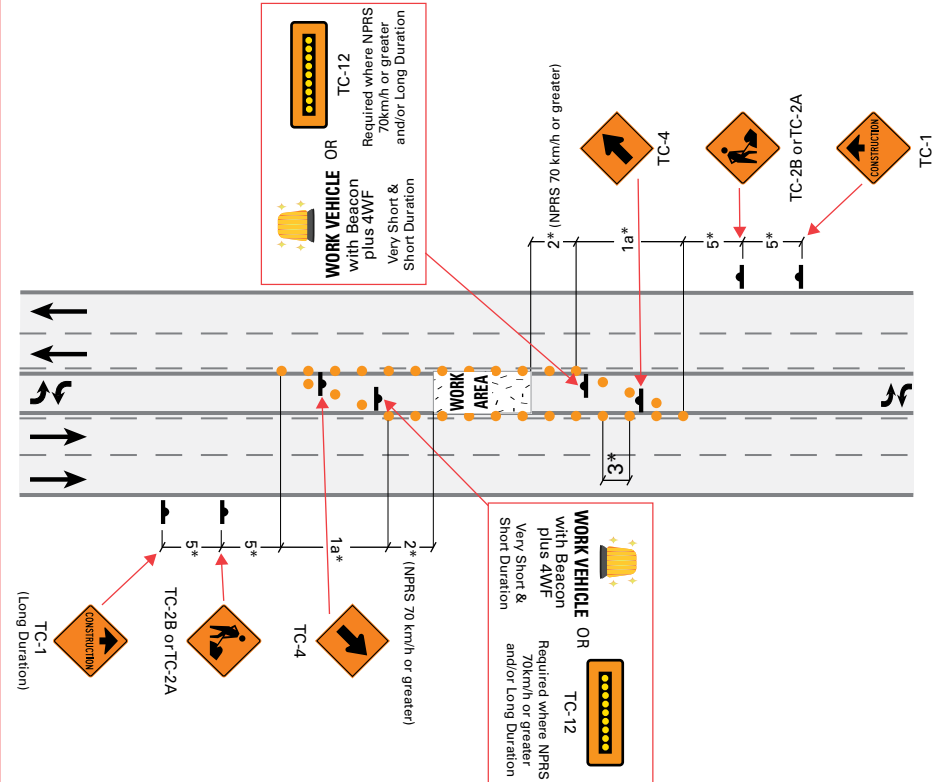

- NOTES**
- * For Short Duration, see [Table A](#). For Long Duration, see [Table B](#).
 - i) Where TC-12s are used for Very Short Duration & Short Duration work, and the NPPS is less than 70km/h, cones are not required.

Figure TL-33 Four Lane Road: Two Lanes Closed

| | |
|--|---|
| <input type="checkbox"/> Two-Lane | <input type="checkbox"/> Mobile Operations |
| <input checked="" type="checkbox"/> Multi-Lane | <input type="checkbox"/> Very Short Duration |
| <input checked="" type="checkbox"/> Undivided Non-freeway | <input checked="" type="checkbox"/> Short Duration |
| <input type="checkbox"/> Divided Non-freeway | <input checked="" type="checkbox"/> Long Duration |
| <input type="checkbox"/> Freeway | |

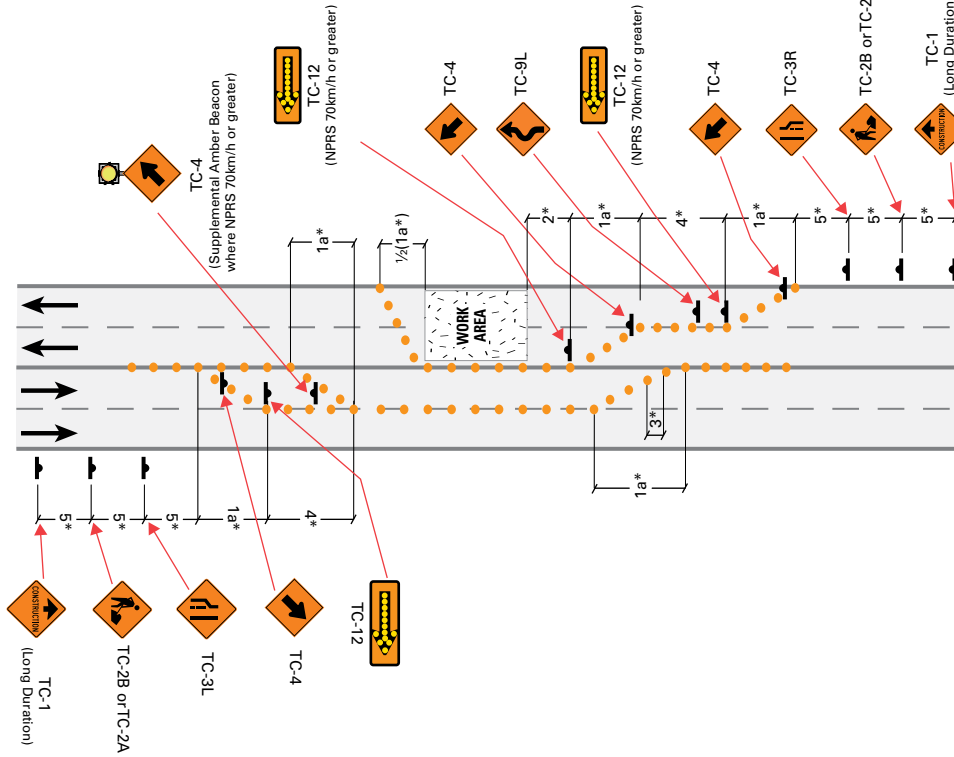

NOTES

- * For Short Duration, see [Table A](#). For Long Duration, see [Table B](#).
- i) For high volume roads or Long Duration work longer than 5 days, the use of Temporary Concrete Barriers should be considered to separate opposing traffic.
- ii) For Divisions exceeding 1km, use a TC-16(ELR) in place of the TC-9(LR), and add an additional TC-16(EREL) at the beginning of end taper.

Figure TL-32 Passing Lanes: Centre Lane Closed

| | |
|--|---|
| <input type="checkbox"/> Two-Lane | <input type="checkbox"/> Mobile Operations |
| <input checked="" type="checkbox"/> Multi-Lane | <input type="checkbox"/> Very Short Duration |
| <input checked="" type="checkbox"/> Undivided Non-freeway | <input checked="" type="checkbox"/> Short Duration |
| <input type="checkbox"/> Divided Non-freeway | <input checked="" type="checkbox"/> Long Duration |
| <input type="checkbox"/> Freeway | |

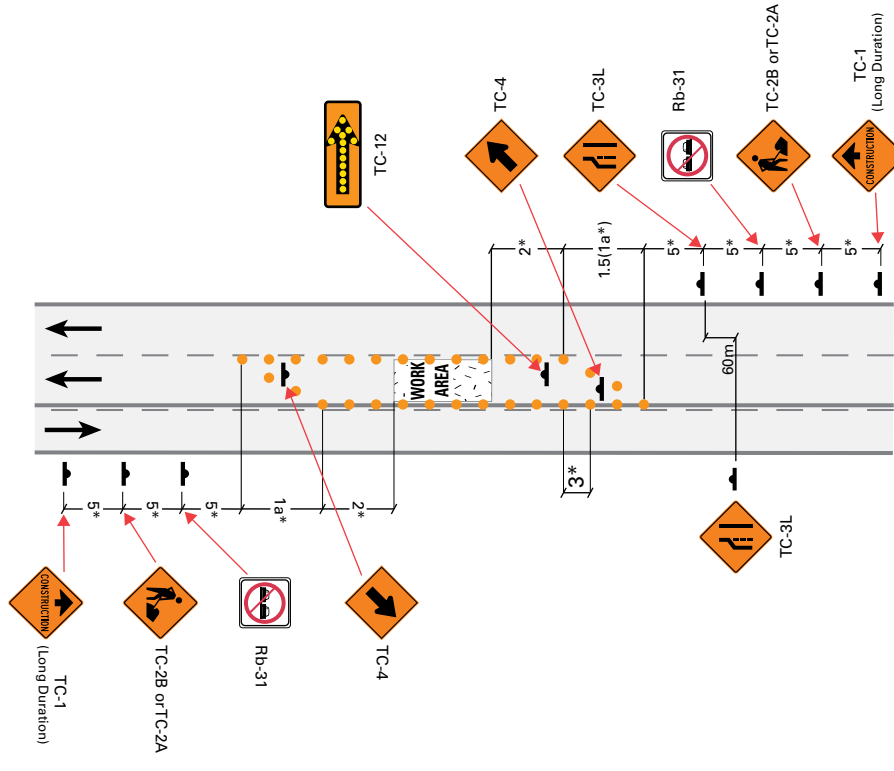

NOTES

- * For Short Duration, see [Table A](#). For Long Duration, see [Table B](#).
- i) The added lane should be allowed to redevelop beyond the Work Zone if there is sufficient remaining lane length to permit safe passing.
- ii) For high volume roads or Long Duration work longer than 5 days, the use of Temporary Concrete Barriers should be considered to separate opposing traffic.

Figure TL-35 Five Lane Road: Two Through Lanes Closed

Two-Lane
 Multi-Lane
 Undivided Non-freeway
 Divided Non-freeway
 Freeway

Mobile Operations
 Very Short Duration
 Short Duration
 Long Duration

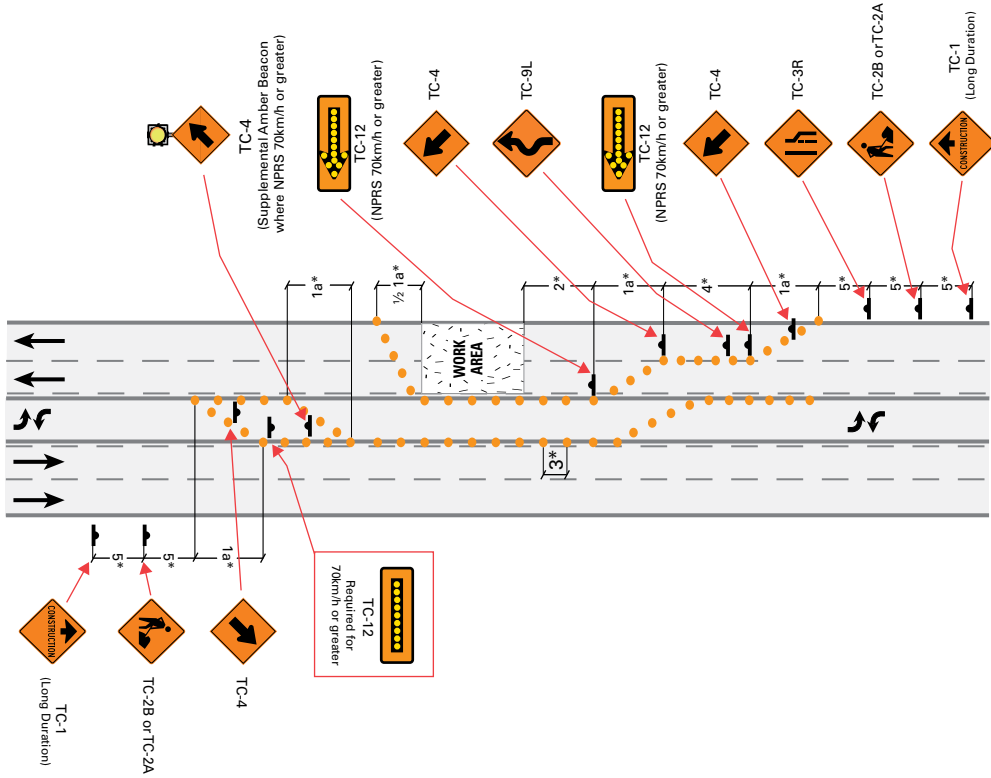

NOTES

i) For diversions, exceeding 1km, use a TC-16EL (ER) in place of the TC-9L (R) and add an additional TC-16ER (EL) at the beginning of end taper.

Figure TL-36 Five Lane Road: Through Lane and Left Turn Lane Closed

Two-Lane
 Multi-Lane
 Undivided Non-freeway
 Divided Non-freeway
 Freeway

Mobile Operations
 Very Short Duration
 Short Duration
 Long Duration

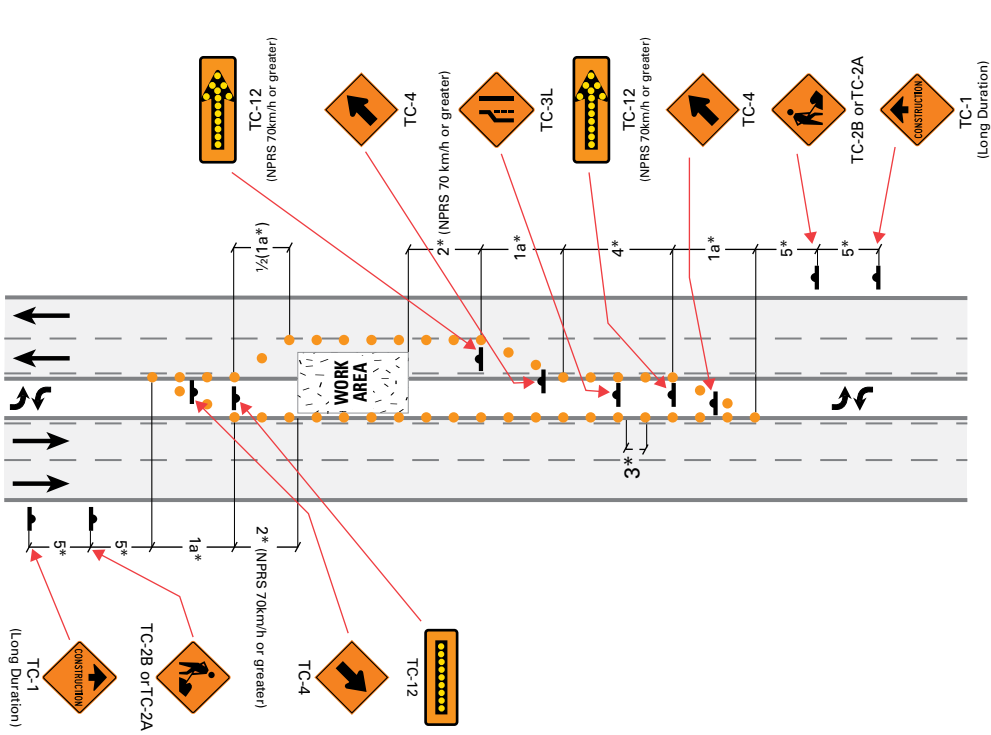

NOTES

* For Short Duration, see Table A. For Long Duration, see Table B.

Figure TL-38 Six Lane Road: Centre Lane or Two Lanes Closed

Two-Lane
 Multi-Lane
 Undivided Non-freeway
 Divided Non-freeway
 Freeway

Mobile Operations
 Very Short Duration
 Short Duration
 Long Duration

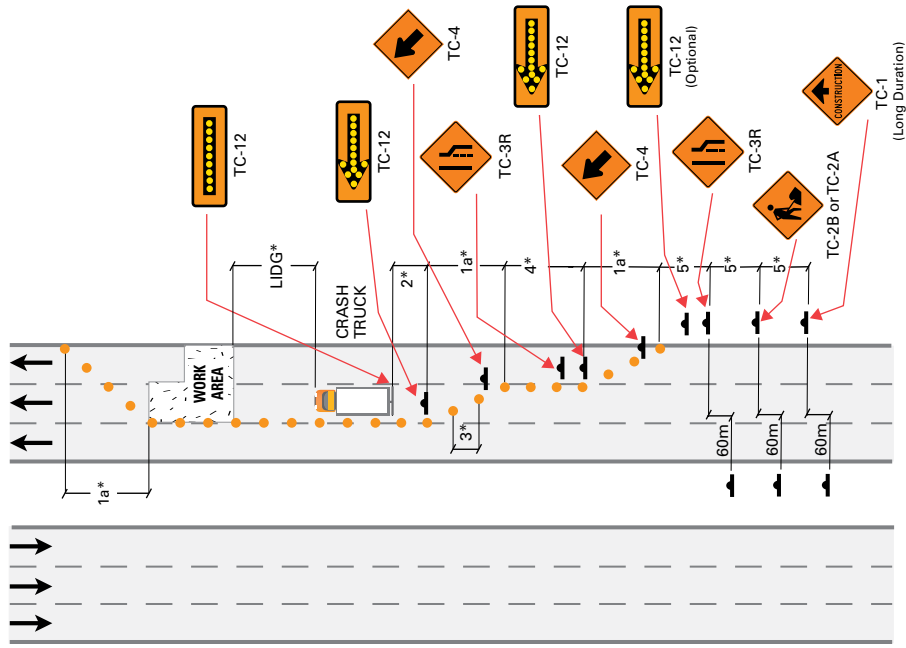

NOTES

* For Freeways, see [Table C](#). For LIDG*, see [Table D](#).

i) For long duration operations (longer than five days), Temporary Concrete Barriers must be used to separate the work area from traffic.

ii) Where signs cannot be accommodated in the median, provide additional signs on the right shoulder or oversize.

iii) Left lane closed: mirror image of right lane closed.

Figure TL-37 Six Lane Road: Centre Lane or Two Lanes closed

Two-Lane
 Multi-Lane
 Undivided Non-freeway
 Divided Non-freeway
 Freeway

Mobile Operations
 Very Short Duration
 Short Duration
 Long Duration

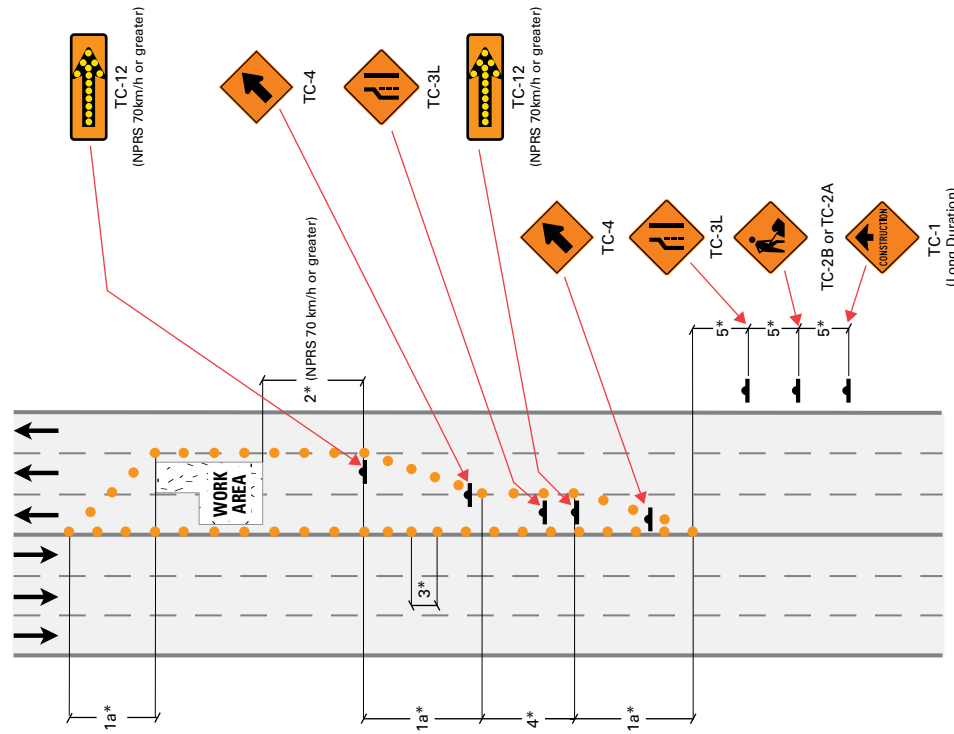

NOTES

* For Short Duration, see [Table A](#). For Long Duration, see [Table B](#).

i) Centreline delineation is not required on divided roads.

ii) Right Lanes closed mirror image, except for TC-3, TC-2 and TC-1.

Figure TL-41 Lane Realignment

| | |
|---|---|
| <input type="checkbox"/> Two-Lane | <input type="checkbox"/> Mobile Operations |
| <input checked="" type="checkbox"/> Multi-Lane | <input type="checkbox"/> Very Short Duration |
| <input checked="" type="checkbox"/> Undivided Non-freeway | <input type="checkbox"/> Short Duration |
| <input checked="" type="checkbox"/> Divided Non-freeway | <input checked="" type="checkbox"/> Long Duration |
| <input checked="" type="checkbox"/> Freeway | |

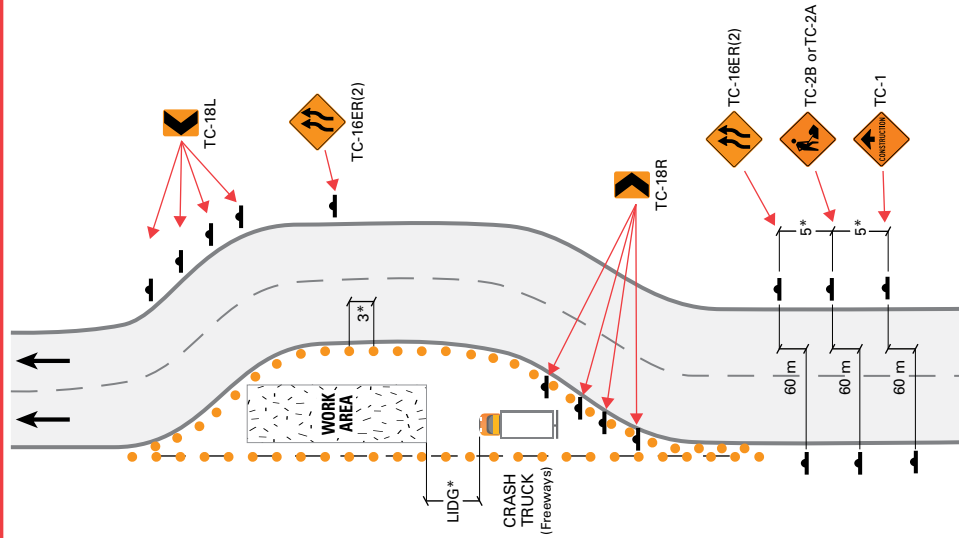

NOTES

- * For Non-Freeways see [Table B](#), for Freeways see [Table C](#).
- i) If Temporary Concrete Barriers are used, the crash truck is not required.
- ii) TC-1A and TC-1B Advance Warning are required for freeways (not shown).

Figure TL-40 Roadside Diversion

| | |
|--|---|
| <input checked="" type="checkbox"/> Two-Lane | <input type="checkbox"/> Mobile Operations |
| <input type="checkbox"/> Multi-Lane | <input type="checkbox"/> Very Short Duration |
| <input type="checkbox"/> Undivided Non-freeway | <input type="checkbox"/> Short Duration |
| <input type="checkbox"/> Divided Non-freeway | <input checked="" type="checkbox"/> Long Duration |
| <input type="checkbox"/> Freeway | |

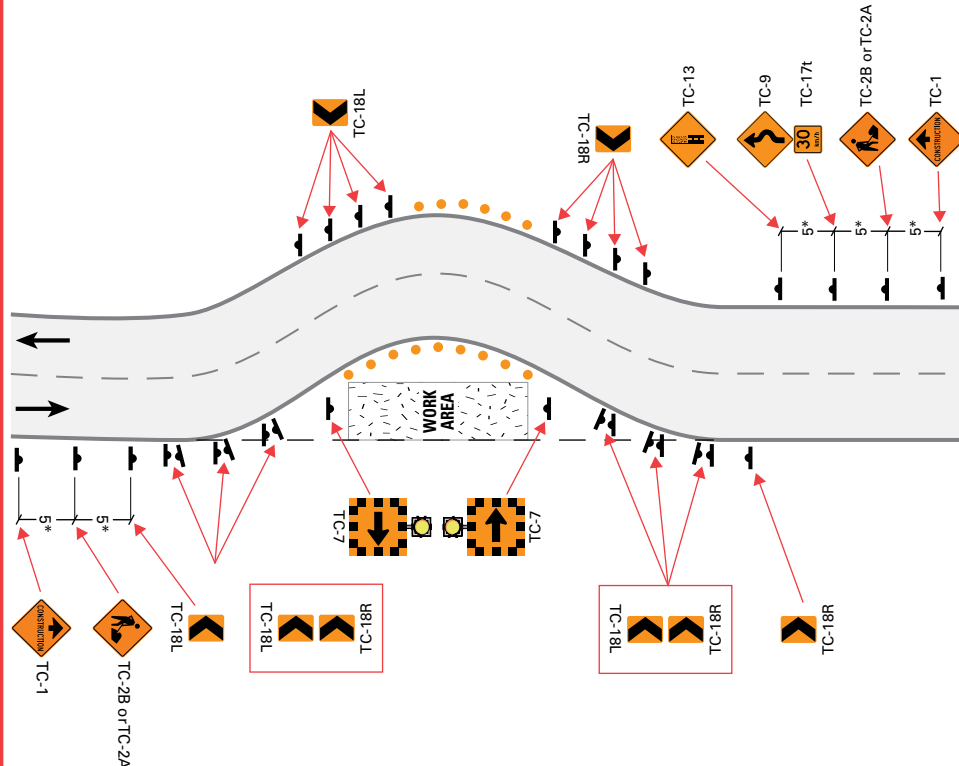

NOTES

- * See [Table B](#).
- i) Traffic should not be shifted onto a surface texture different from the main roadway without a speed reduction.
- ii) If the diversion is paved, temporary pavement markings are required, including edgelines, and the TC-13 should not be used.

Figure TL-42(i)

Detour: Alternative Roads

Two-Lane
 Multi-Lane
 Mobile Operations
 Very Short Duration
 Short Duration
 Long Duration
 Undivided Non-freeway
 Divided Non-freeway
 Freeway

The following signs are to be used in the layout for Route Detours - see TL-42(ii).

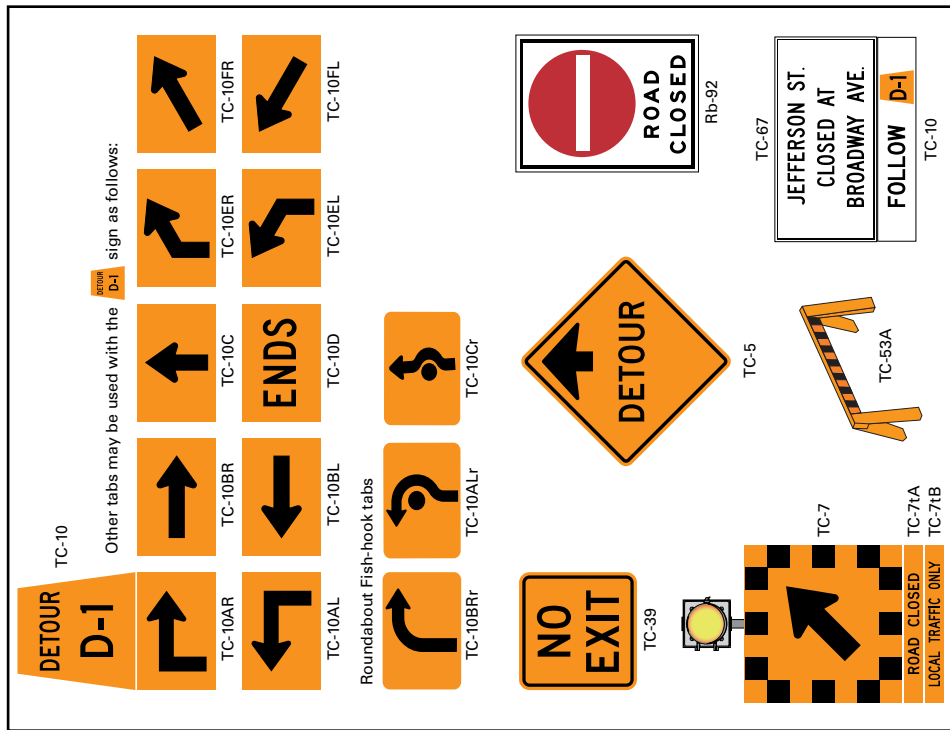

NOTES

- i) See TL-42(i) for Sign Details.
- ii) The same approach to signing is required in the opposite direction.

Figure TL-42(ii)

Route Detour (Alternative Roads)

Two-Lane
 Multi-Lane
 Mobile Operations
 Very Short Duration
 Short Duration
 Long Duration
 Undivided Non-freeway
 Divided Non-freeway
 Freeway

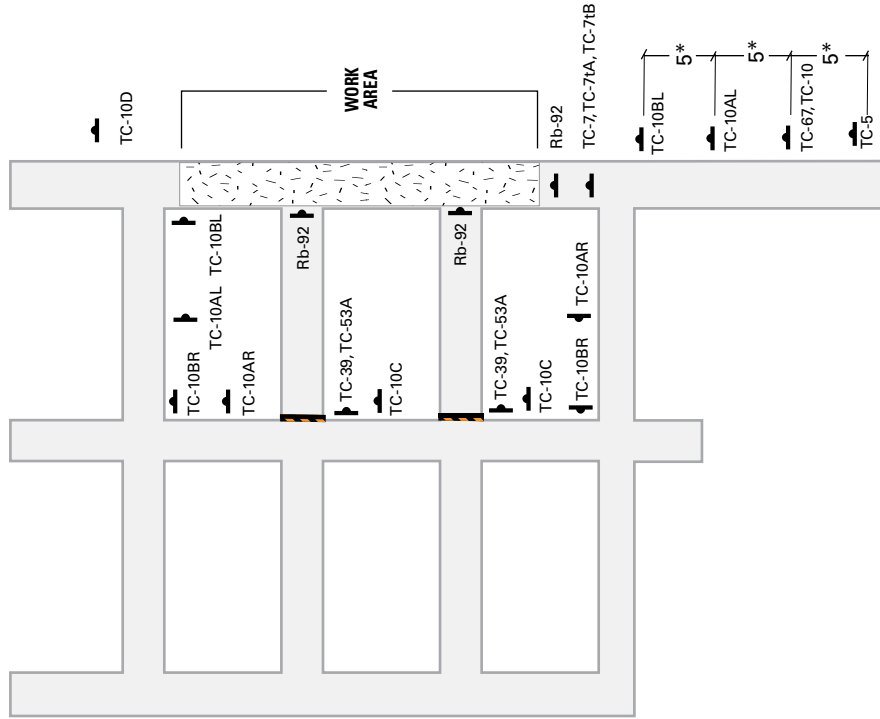

* For Short Duration see Table A, for Long Duration see Table B.

NOTES

- i) See TL-42(i) for Sign Details.
- ii) The same approach to signing is required in the opposite direction.

Figure TL-43

Lane Closed at Exit Ramp

| | |
|---|--|
| <input type="checkbox"/> Two-Lane | <input type="checkbox"/> Mobile Operations |
| <input checked="" type="checkbox"/> Multi-Lane | <input type="checkbox"/> Very Short Duration |
| <input checked="" type="checkbox"/> Undivided Non-freeway | <input checked="" type="checkbox"/> Short Duration |
| <input checked="" type="checkbox"/> Divided Non-freeway | <input checked="" type="checkbox"/> Long Duration |
| <input checked="" type="checkbox"/> Freeway | |

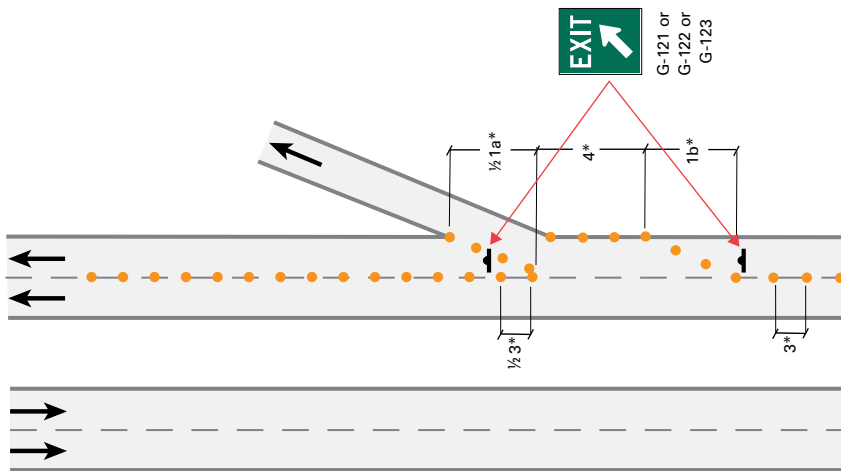

* Non-Freeways: For Short Duration, see Table A; For Long Duration, see Table B. Freeways: See Table C.

- NOTES
- i) For Right Lane Closed, see Figure TL-29.
 - ii) In the immediate area of the Exit, Cone or Barrel spacings of half of those shown on Table A, B or C should be used.
 - iii) If a Deceleration Lane is present, the Normal Deceleration Lane is coned-off and the Closed Lane becomes the Deceleration Lane as shown.

Figure TL-44

Lane Closed at Entrance Ramp

| | |
|---|--|
| <input type="checkbox"/> Two-Lane | <input type="checkbox"/> Mobile Operations |
| <input checked="" type="checkbox"/> Multi-Lane | <input type="checkbox"/> Very Short Duration |
| <input checked="" type="checkbox"/> Undivided Non-freeway | <input checked="" type="checkbox"/> Short Duration |
| <input checked="" type="checkbox"/> Divided Non-freeway | <input checked="" type="checkbox"/> Long Duration |
| <input checked="" type="checkbox"/> Freeway | |

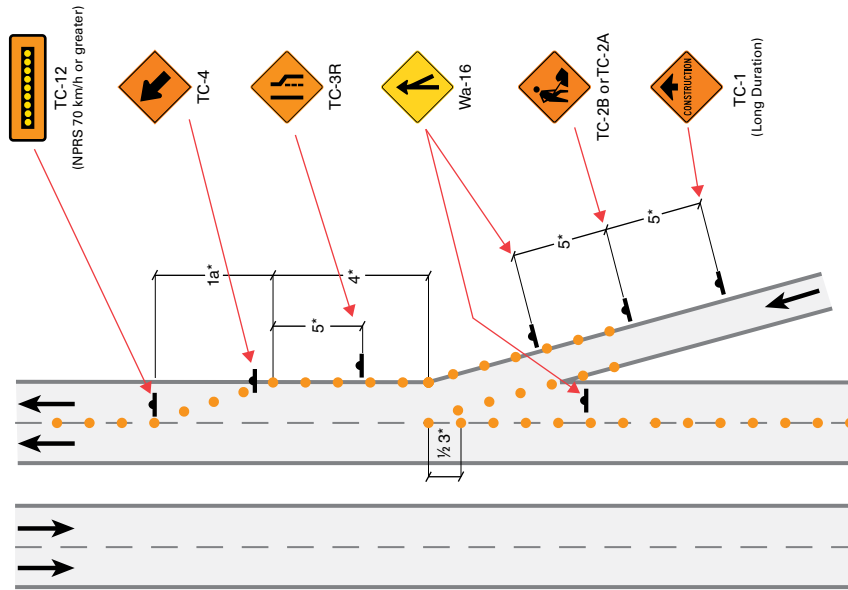

* Non-Freeways: For Short Duration, see Table A; For Long Duration, see Table B. Freeways: See Table C.

- NOTES
- i) For Right Lane Closed, see Figure TL-29.
 - ii) Where space and work activities permit, the acceleration lane should be made as long as possible.
 - iii) In the immediate area of the Entrance, Cone or Barrel spacings of half of those shown on Table A, B or C should be used.

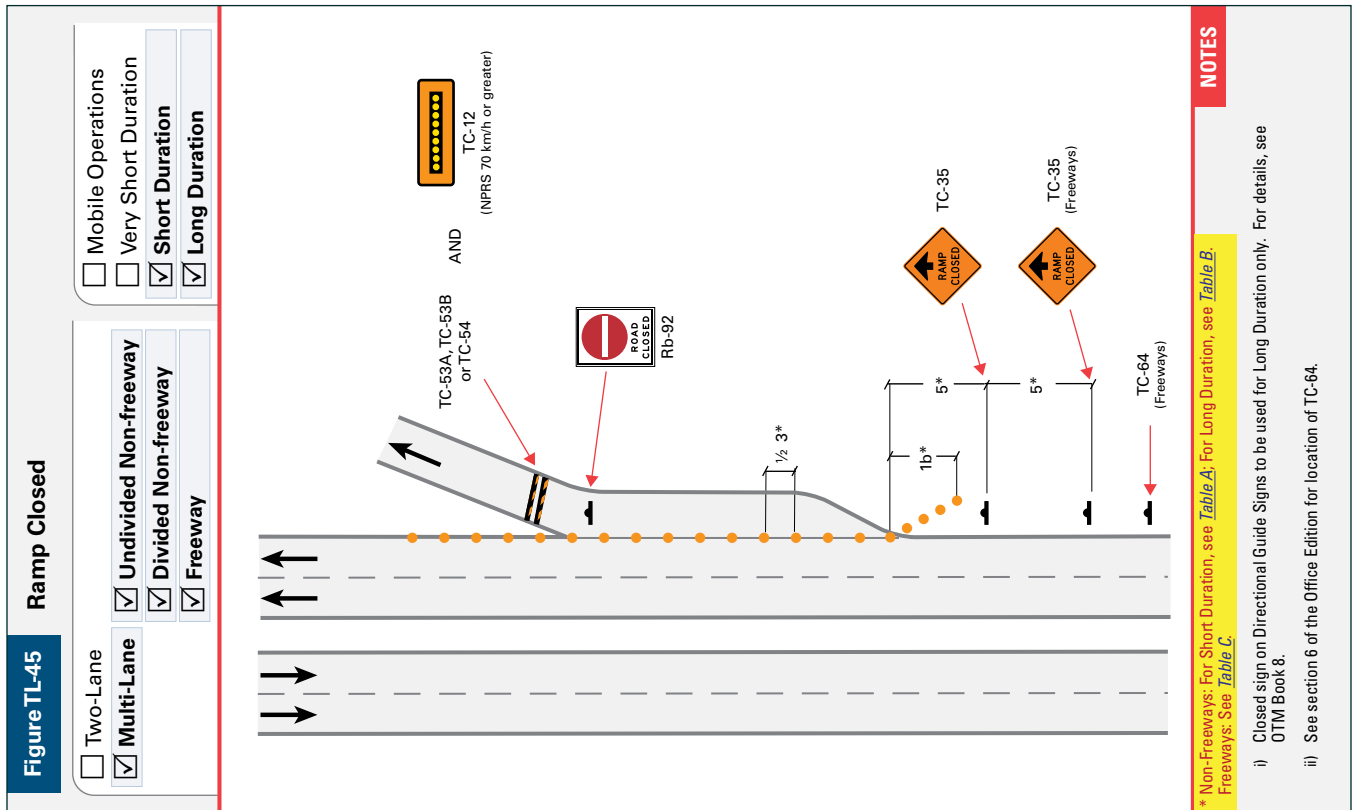
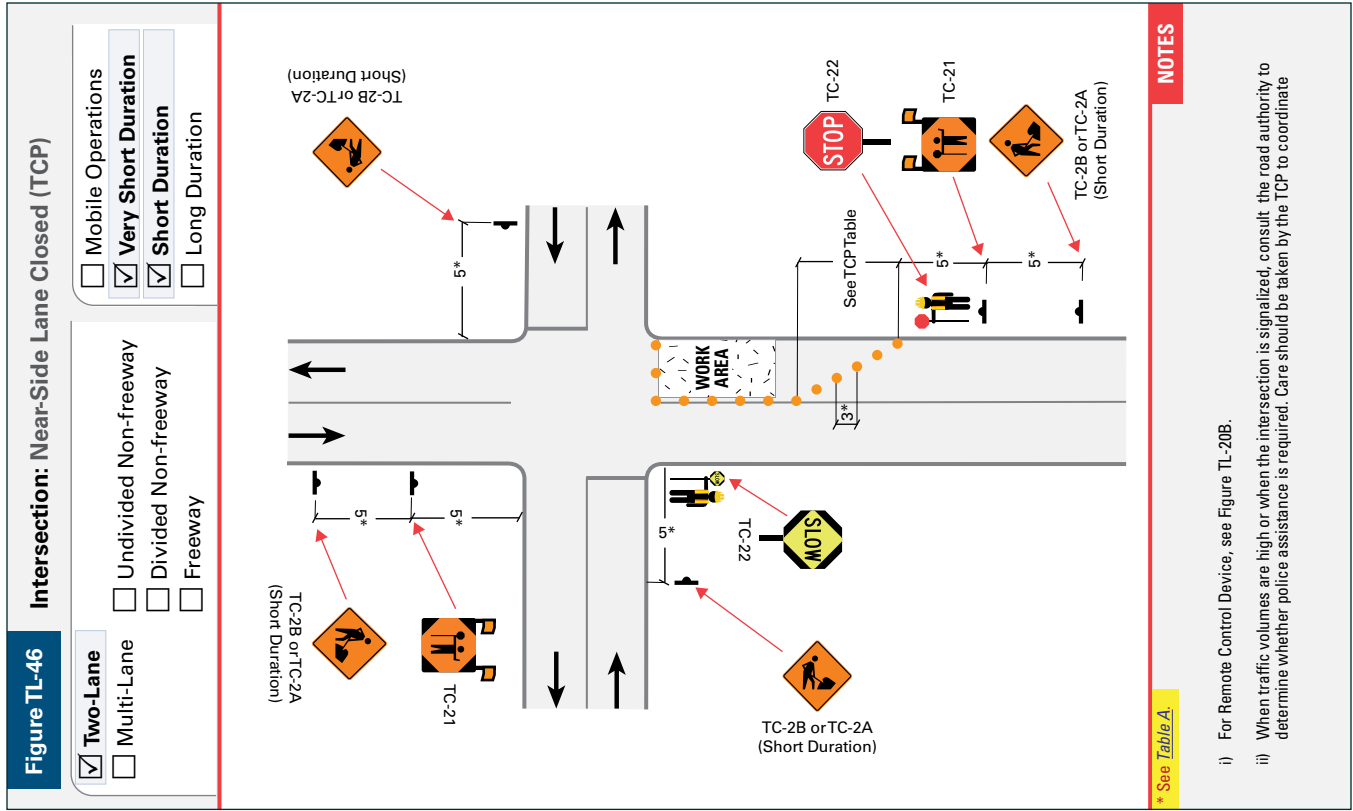

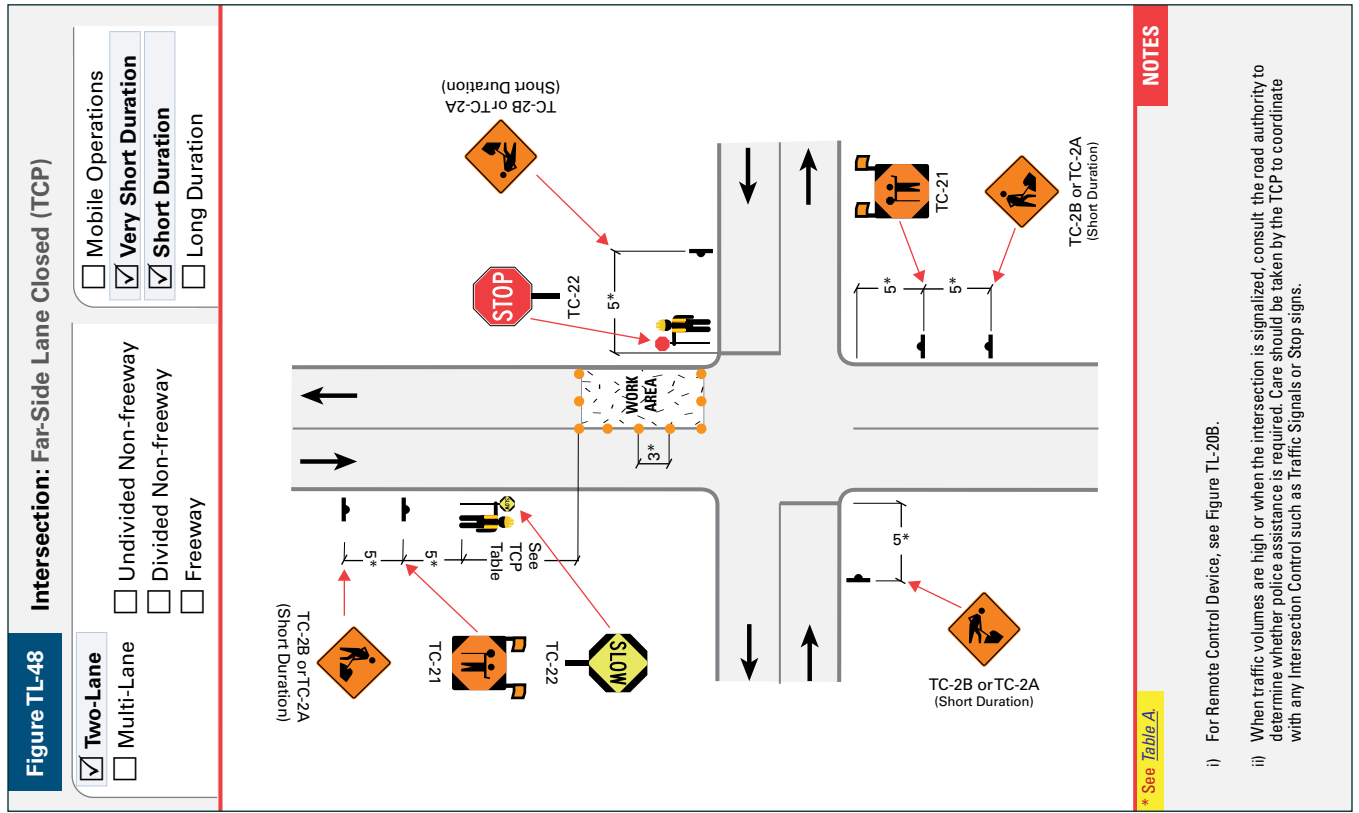
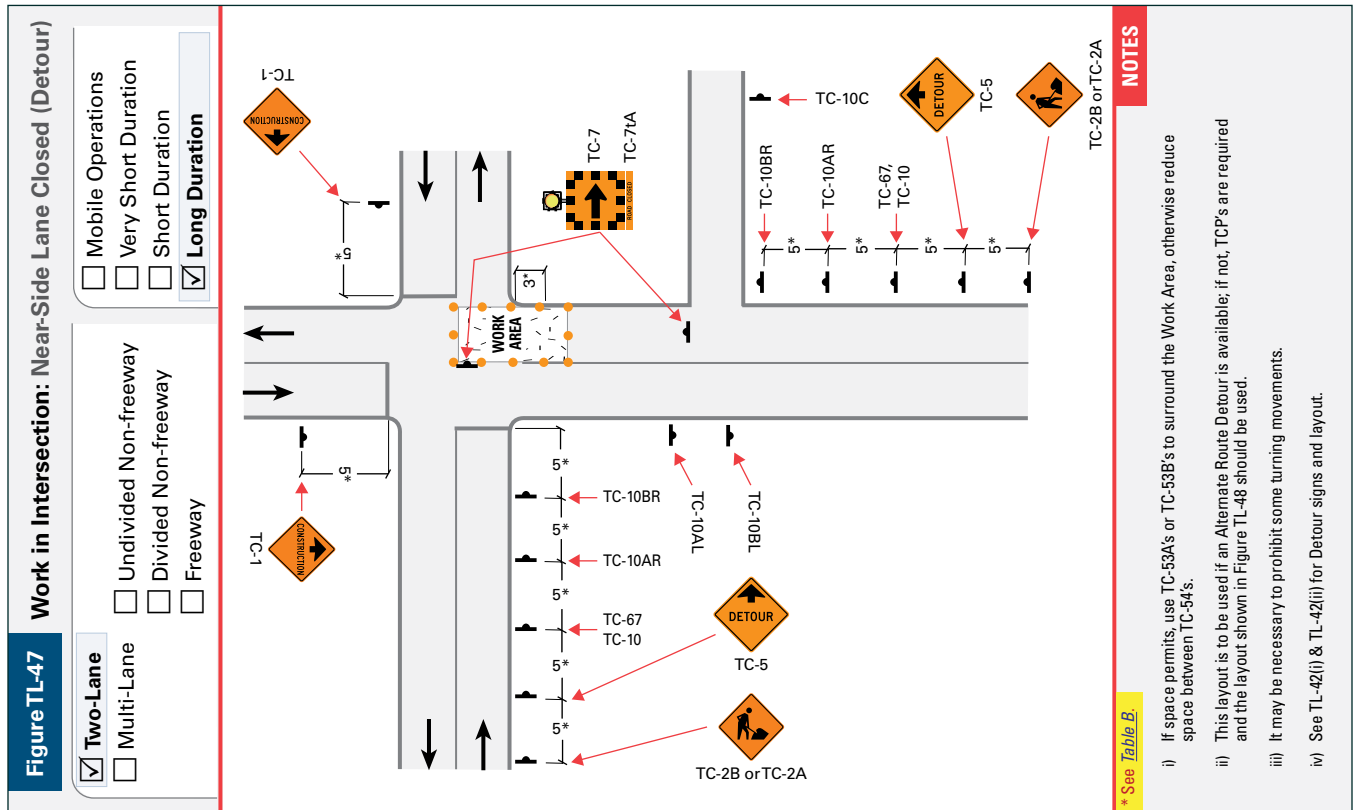

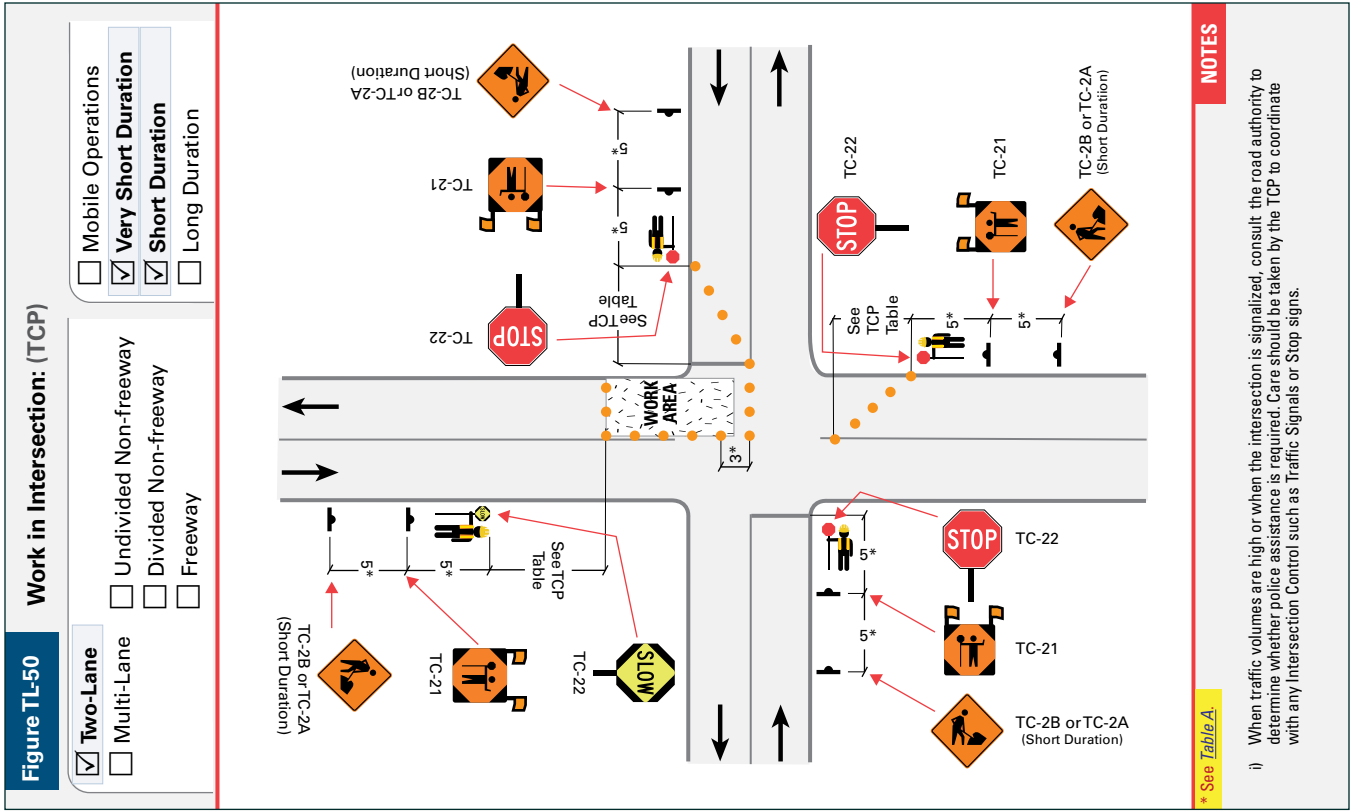
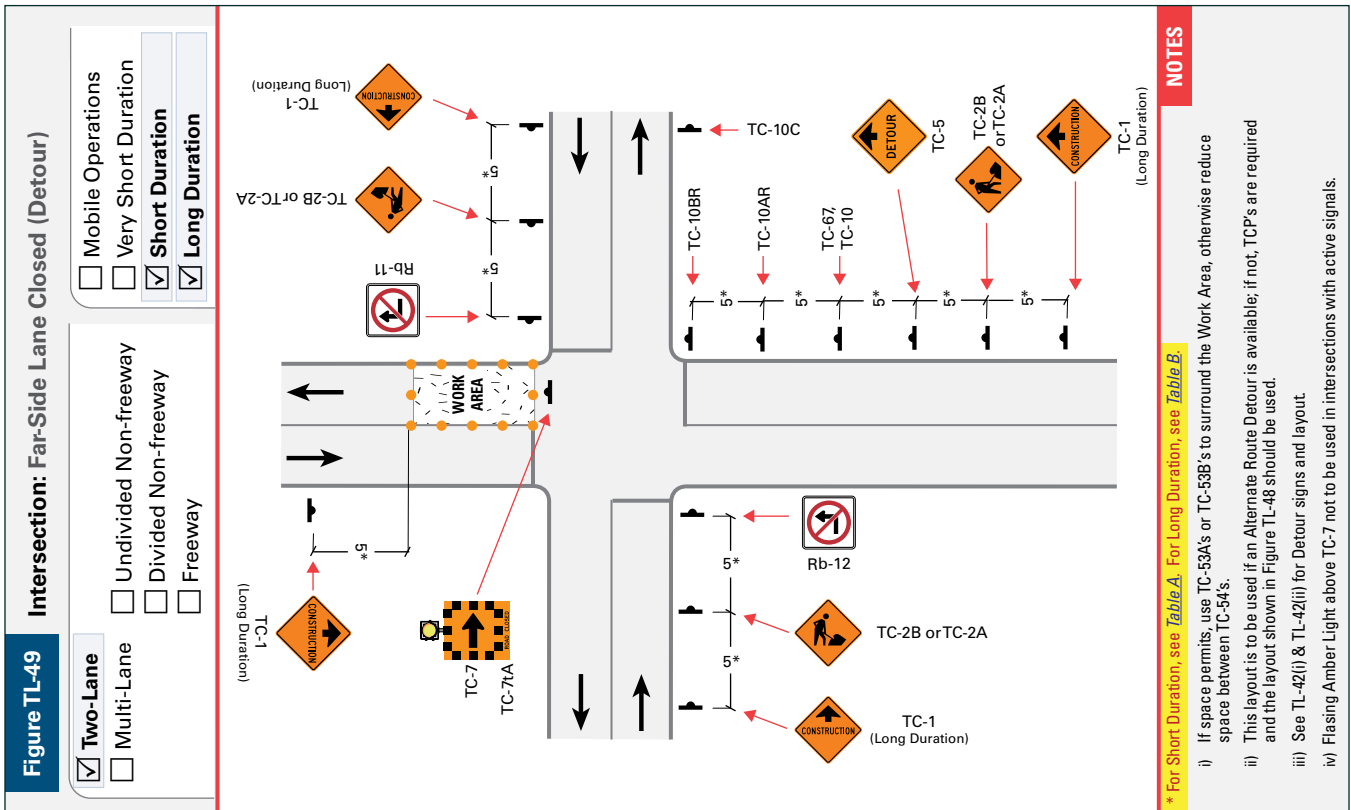

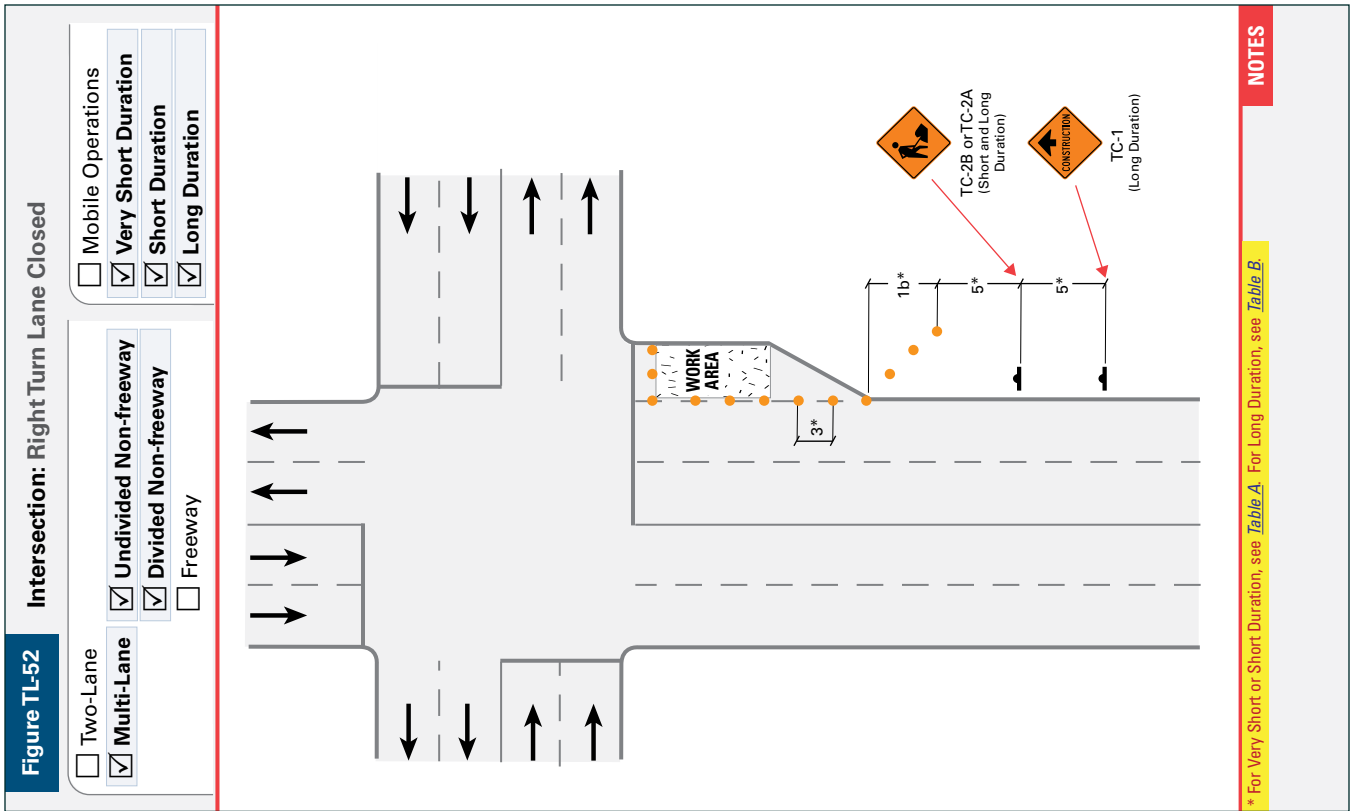
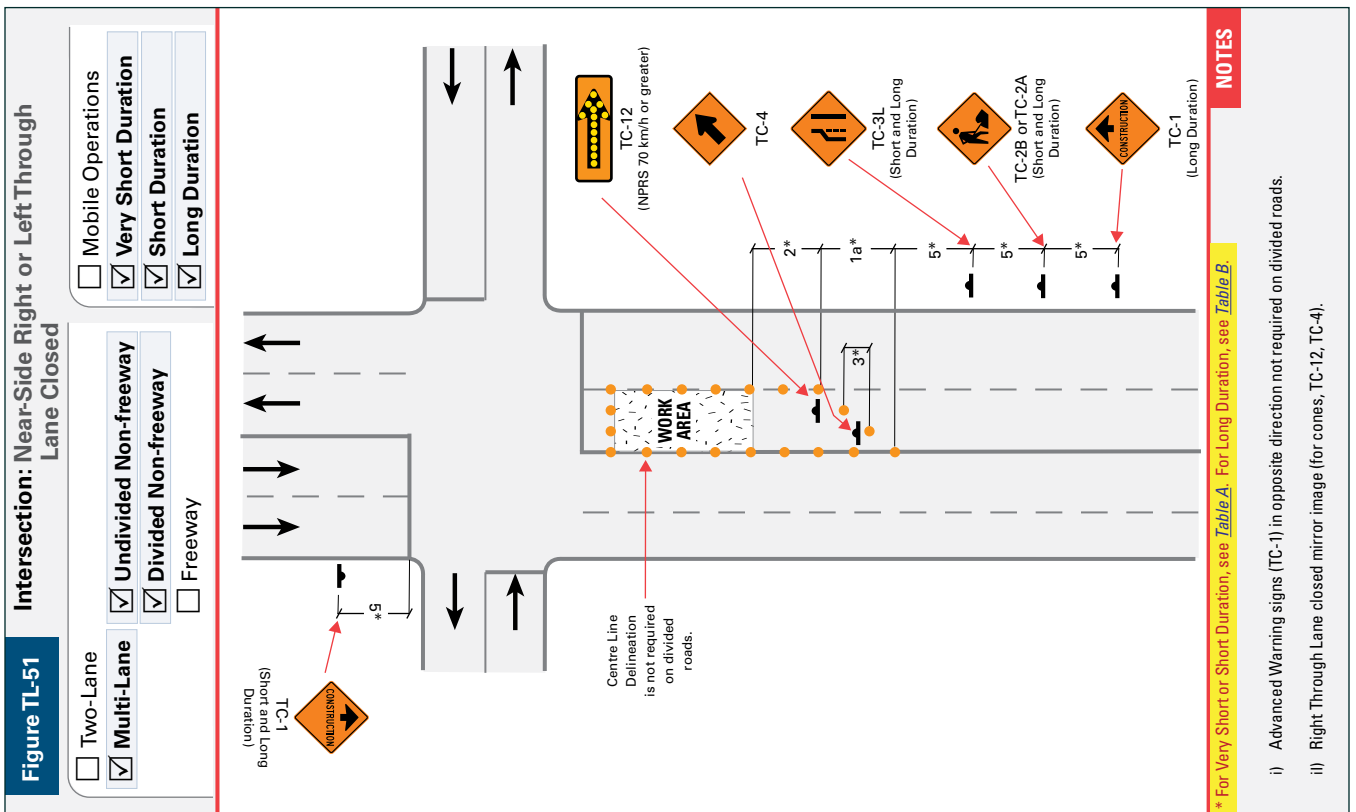

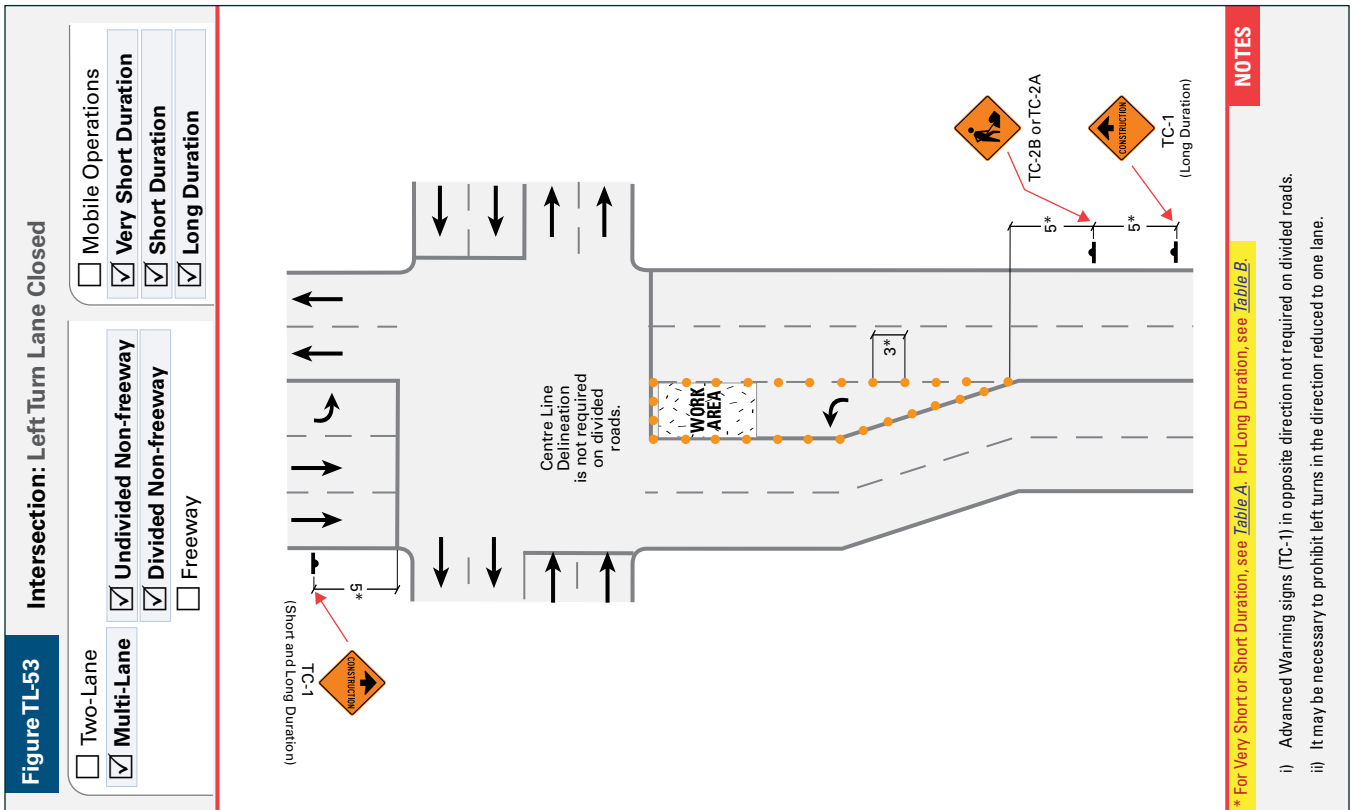
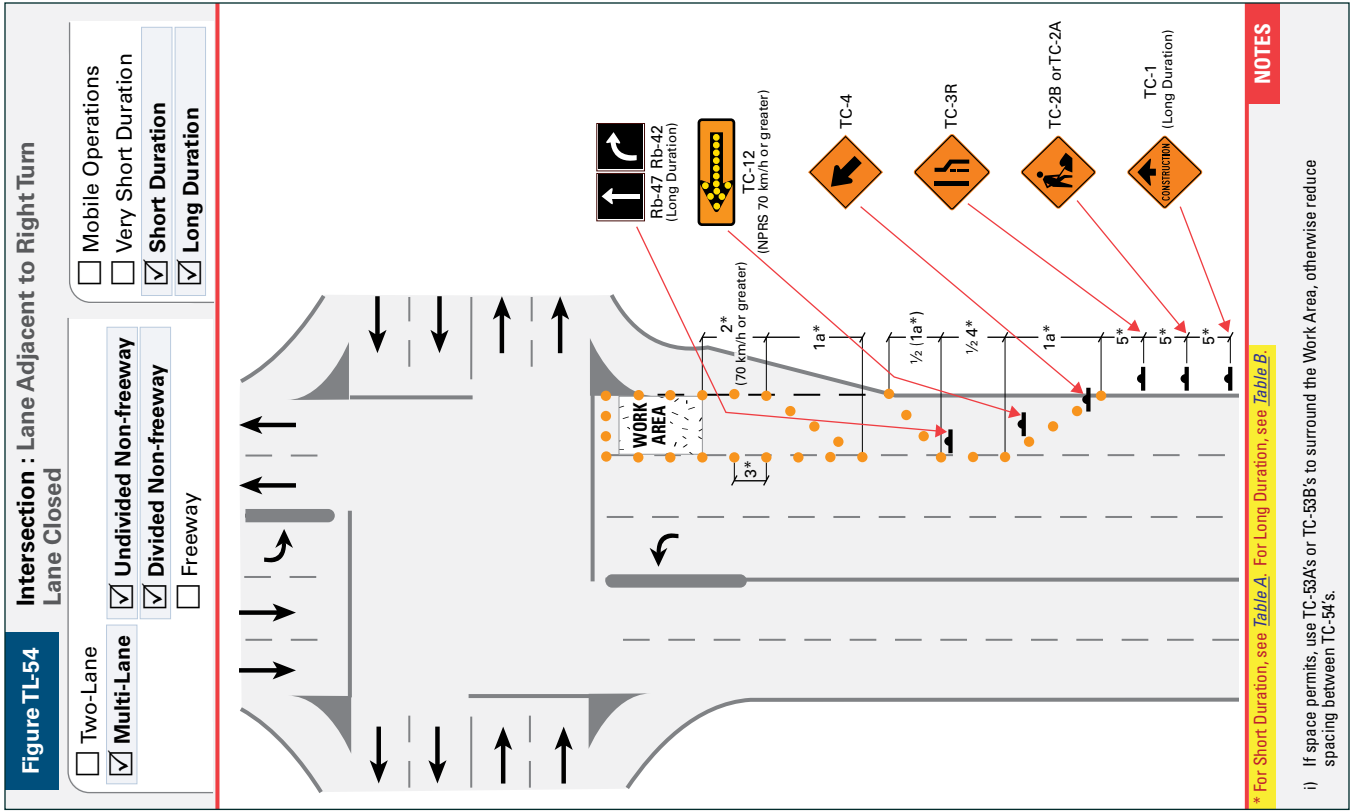

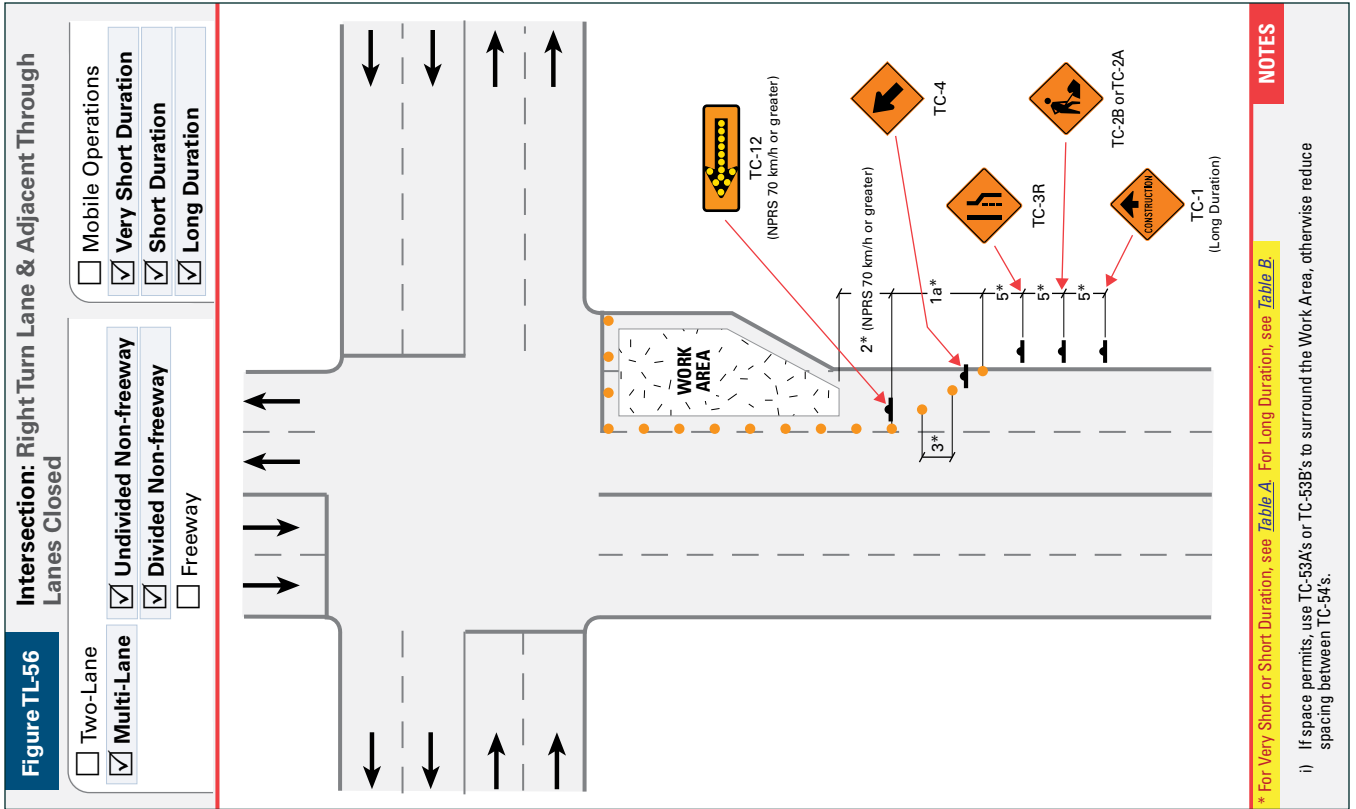
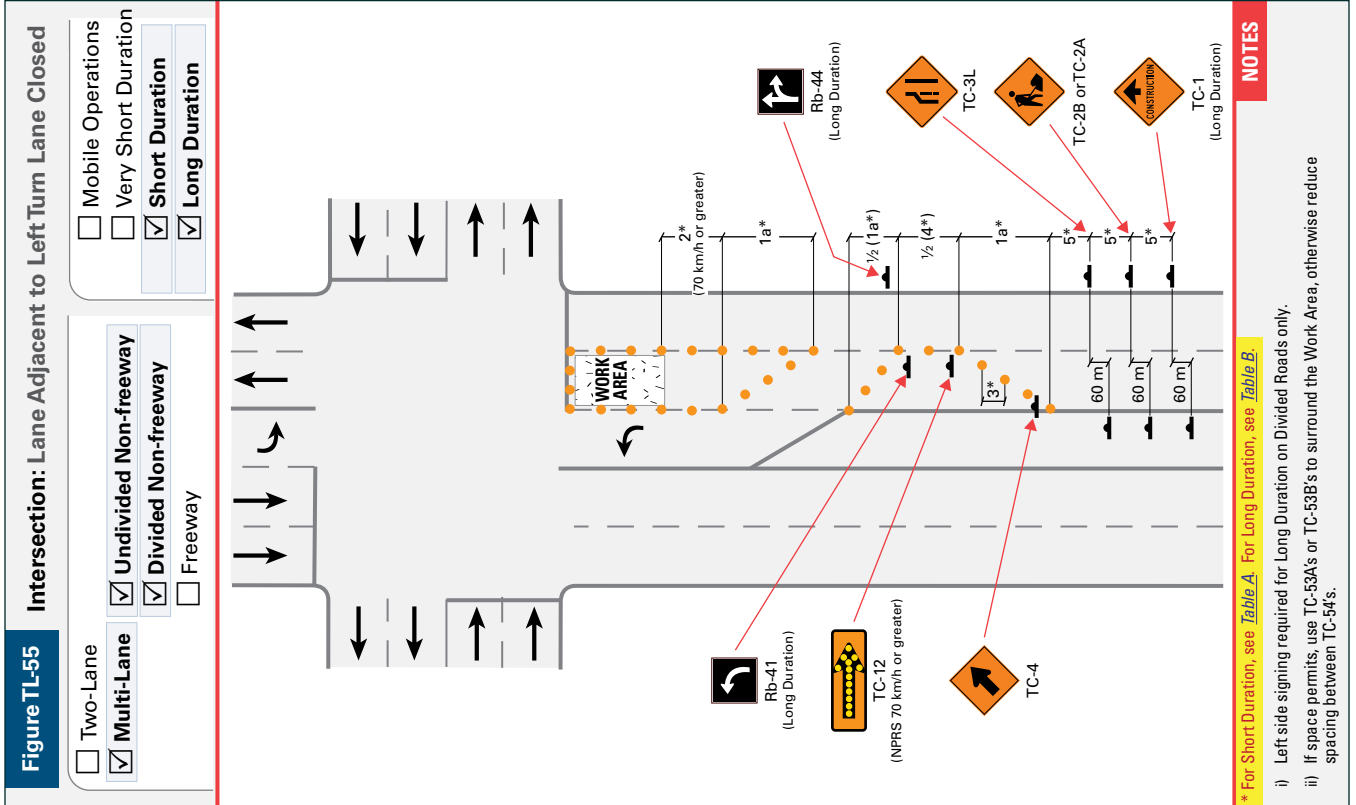

NOTES

* For Very Short or Short Duration, see [Table A](#). For Long Duration, see [Table B](#).

i) If space permits, use TC-53As or TC-53B's to surround the Work Area, otherwise reduce spacing between TC-54's.

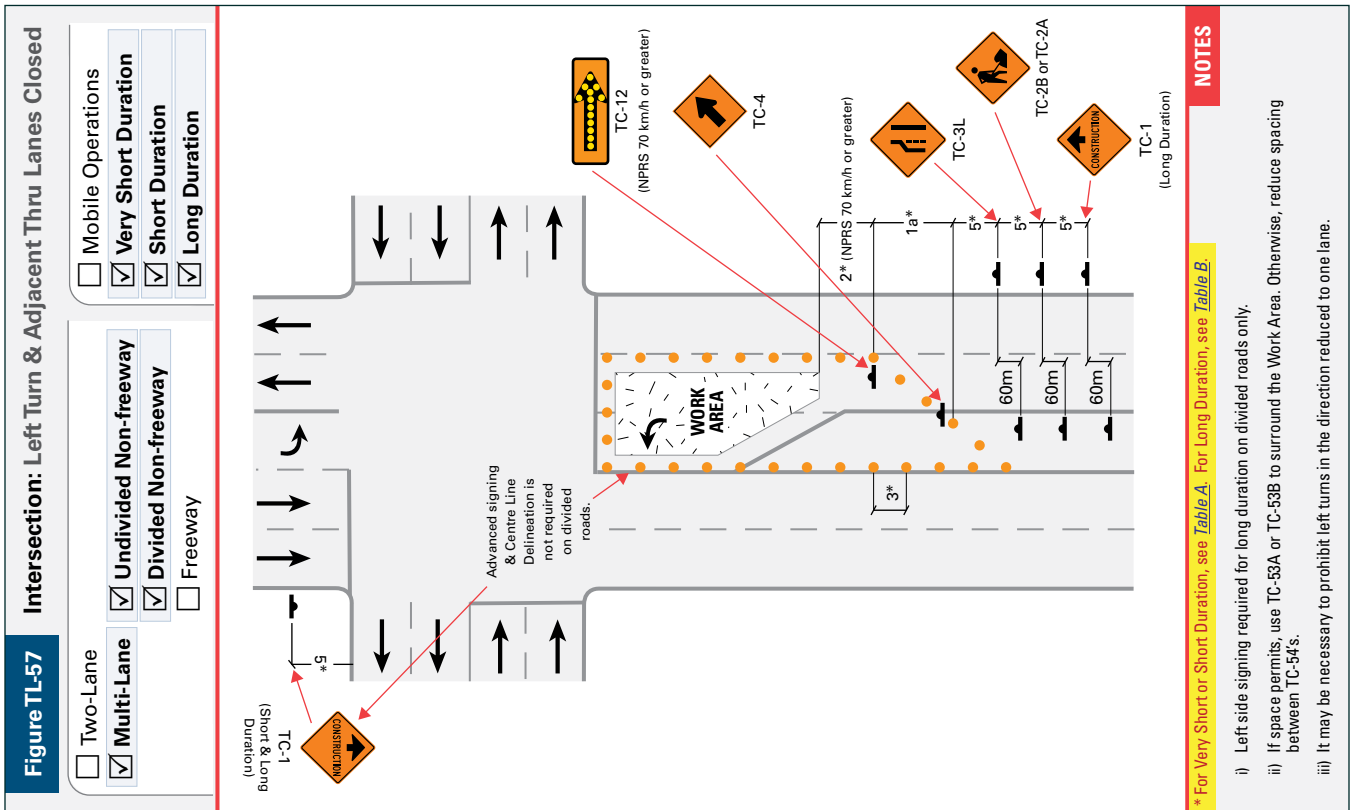
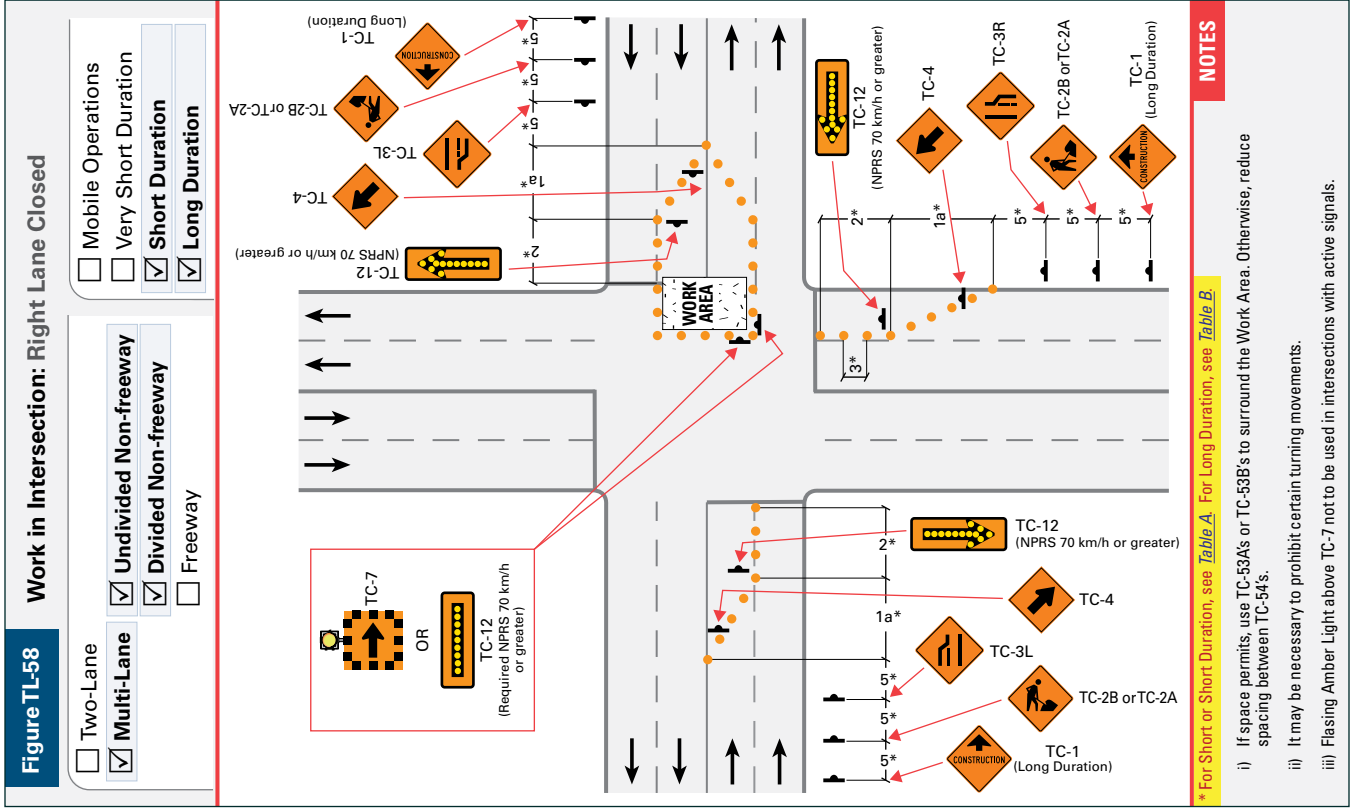
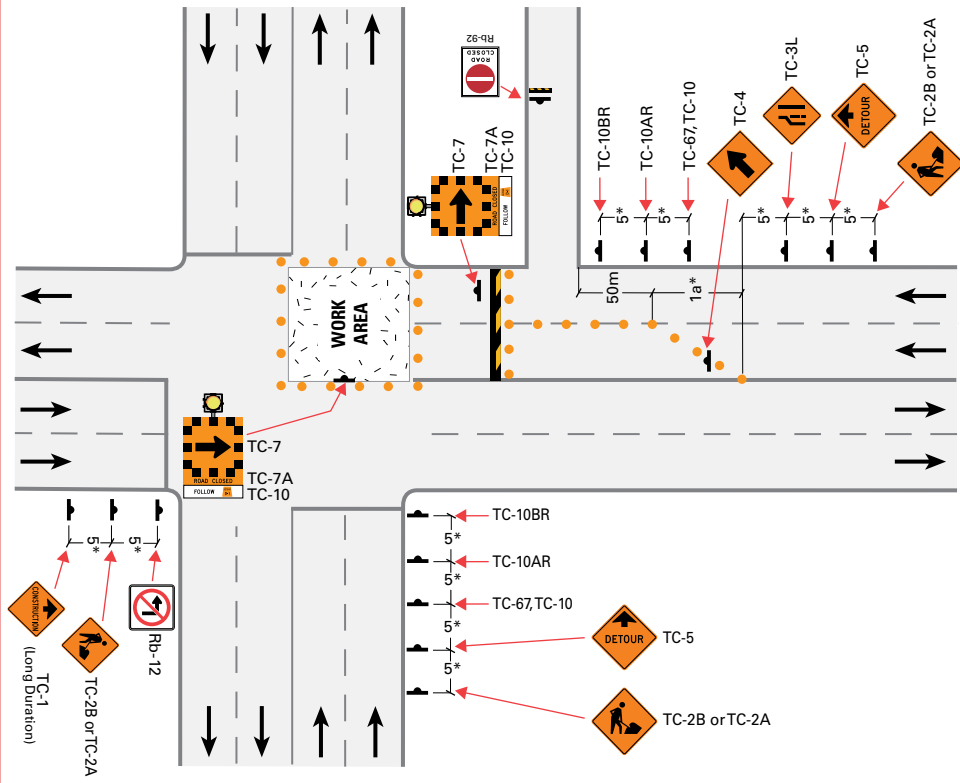

Figure TL-60A Work in Intersection: Road Closed (Detour) - Option 1

| | |
|---|--|
| <input type="checkbox"/> Two-Lane | <input type="checkbox"/> Mobile Operations |
| <input checked="" type="checkbox"/> Multi-Lane | <input type="checkbox"/> Very Short Duration |
| <input checked="" type="checkbox"/> Undivided Non-freeway | <input checked="" type="checkbox"/> Short Duration |
| <input checked="" type="checkbox"/> Divided Non-freeway | <input checked="" type="checkbox"/> Long Duration |
| <input type="checkbox"/> Freeway | |



- NOTES**
- * For Short or Short Duration, see [Table A](#). For Long Duration, see [Table B](#).
 - i) If space permits, use TC-53A's or TC-53B's to surround the Work Area. Otherwise, reduce spacing between TC-54's.
 - ii) See Figure TL-42(ii) "Route Detour", for applicable layout.
 - iii) Flashing Amber Light above TC-7 not to be used in intersections with active signals.

Figure TL-59 Work in Intersection: Left Lane Closed

| | |
|---|--|
| <input type="checkbox"/> Two-Lane | <input type="checkbox"/> Mobile Operations |
| <input checked="" type="checkbox"/> Multi-Lane | <input type="checkbox"/> Very Short Duration |
| <input checked="" type="checkbox"/> Undivided Non-freeway | <input checked="" type="checkbox"/> Short Duration |
| <input checked="" type="checkbox"/> Divided Non-freeway | <input checked="" type="checkbox"/> Long Duration |
| <input type="checkbox"/> Freeway | |

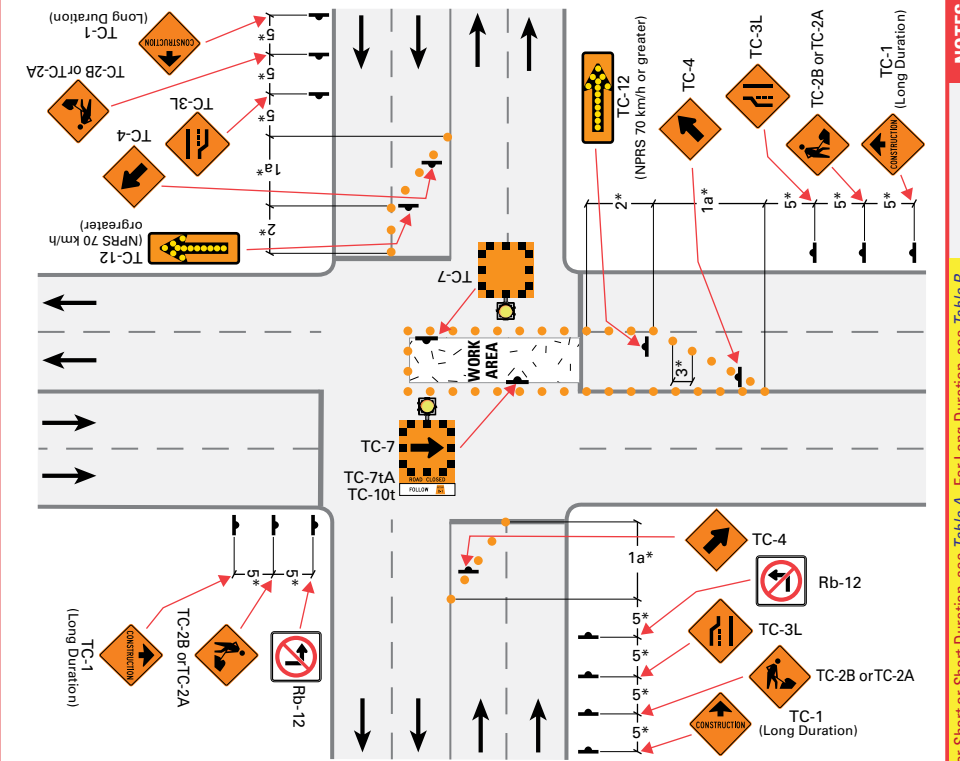

- NOTES**
- * For Short or Short Duration, see [Table A](#). For Long Duration, see [Table B](#).
 - i) If space permits, use TC-53A's or TC-53B's to surround the Work Area. Otherwise, reduce spacing between TC-54's.
 - ii) It may be necessary to prohibit additional turning movements.
 - iii) Flashing Amber Light above TC-7 not to be used in intersections with active signals.
 - iv) See Figure TL-42B "Route Detour", for applicable layout.

Figure TL-61 Intersection: Far-Side Lane Closed

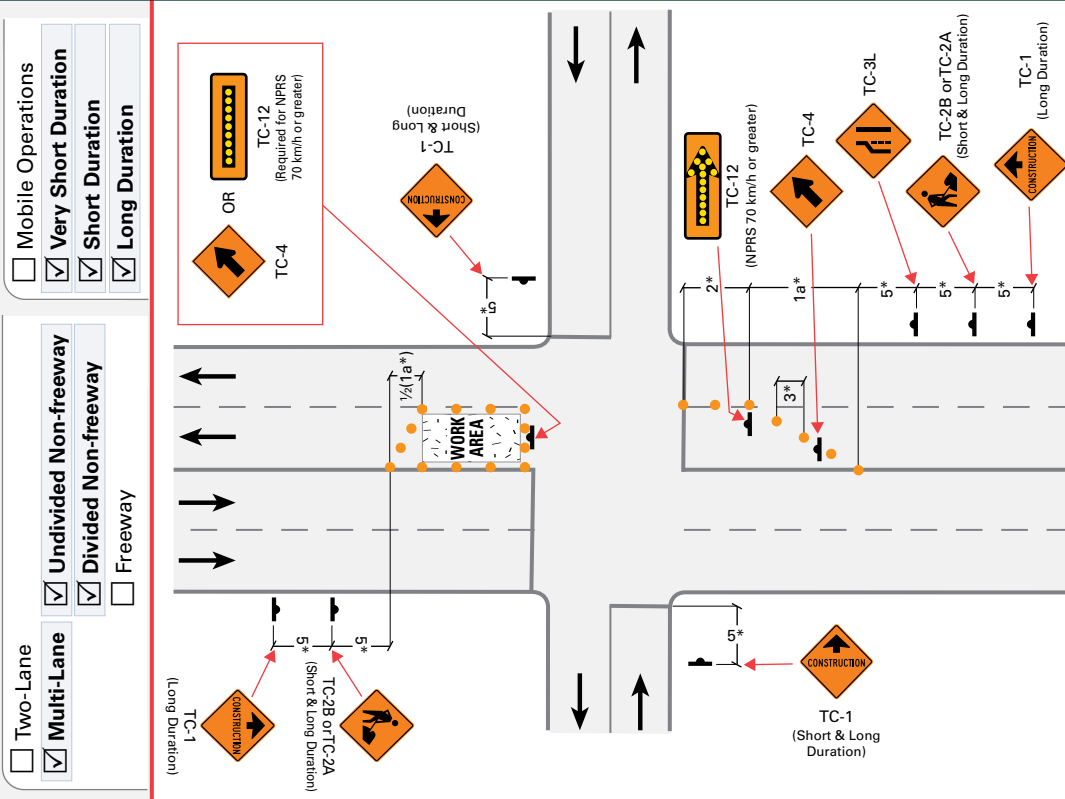

NOTES

- i) Right Lane Closed is mirror image (Advance signs (TC-1 & TC-2) not required in opposing direction).
- ii) Measures should be taken to make sure on-street parking is not allowed next to the Work Area or Taper.
- iii) On Divided Road Advance signs, (TC-1 & TC-2), not required in opposing direction.

* For Short or Short Duration, see [Table A](#). For Long Duration, see [Table B](#).

Figure TL-60B Work in Intersection: Two Lanes Closed - Option 2

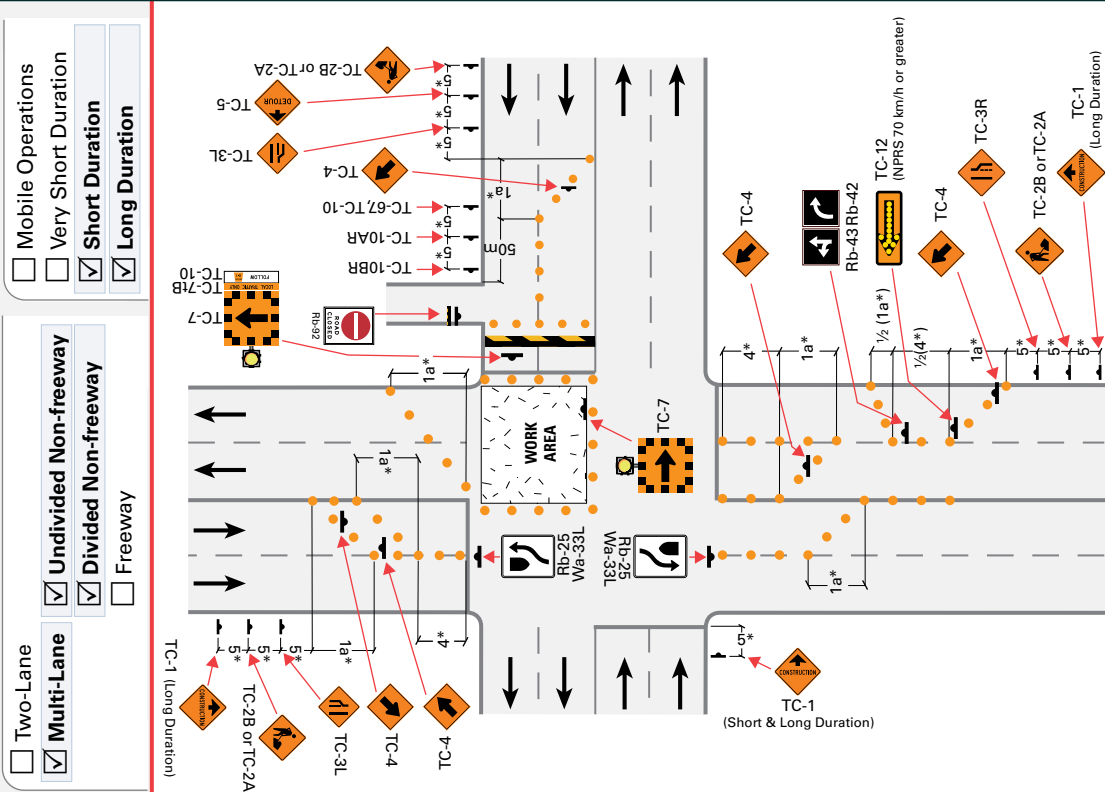

NOTES

- i) If space permits, use TC-53As or TC-53B's to surround the Work Area. Otherwise, reduce spacing between TC-54's.
- ii) See Figure TL-42(iii) "Route Detour", for applicable layout.
- iii) Flashing Amber Light above TC-7 not to be used in intersections with active signals.
- iv) It may be necessary to prohibit certain turning movements.

* For Short or Short Duration, see [Table A](#). For Long Duration, see [Table B](#).

Figure TL-62
Intersection: Right Turn Lane (Far-Side)
Right Lane Closed

Two-Lane
 Multi-Lane
 Undivided Non-freeway
 Divided Non-freeway
 Freeway

Mobile Operations
 Very Short Duration
 Short Duration
 Long Duration

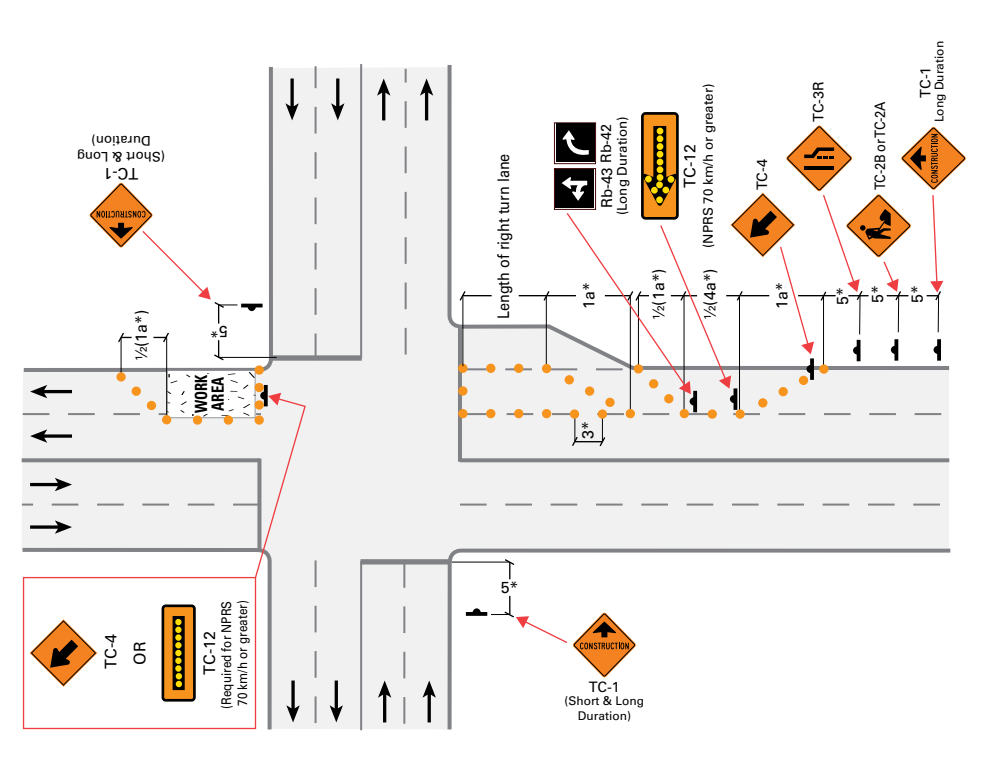

NOTES

* For Short Duration, see [Table A](#). For Long Duration, see [Table B](#).

i) If space permits, use TC-53As or TC-53B's to surround the Work Area otherwise, reduce spacing between TC-54s.

ii) It may be necessary to prohibit certain turning movements.

iii) It may be necessary to prohibit right turn movements.

Figure TL-63
Intersection: (Left Turn Lane Open) Far-Side Left
Lane Closed

Two-Lane
 Multi-Lane
 Undivided Non-freeway
 Divided Non-freeway
 Freeway

Mobile Operations
 Very Short Duration
 Short Duration
 Long Duration

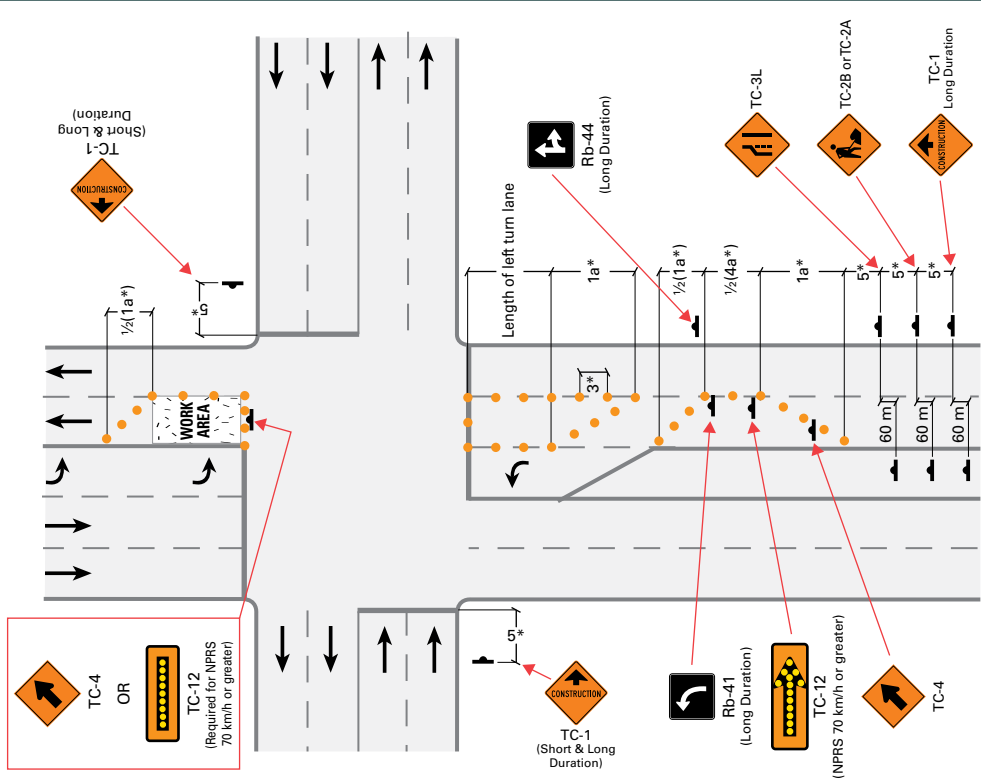

NOTES

* For Short Duration, see [Table A](#). For Long Duration, see [Table B](#).

i) If space permits, use TC-53As or TC-53B's to surround the Work Area otherwise, reduce spacing between TC-54s.

ii) Repeated Left side signing required for Long Duration on Divided Roads only.

iii) It may be necessary to prohibit right turn movements.

Figure TL-65 Pedestrian Accommodation: Intersection Sidewalk Detour onto Roadway

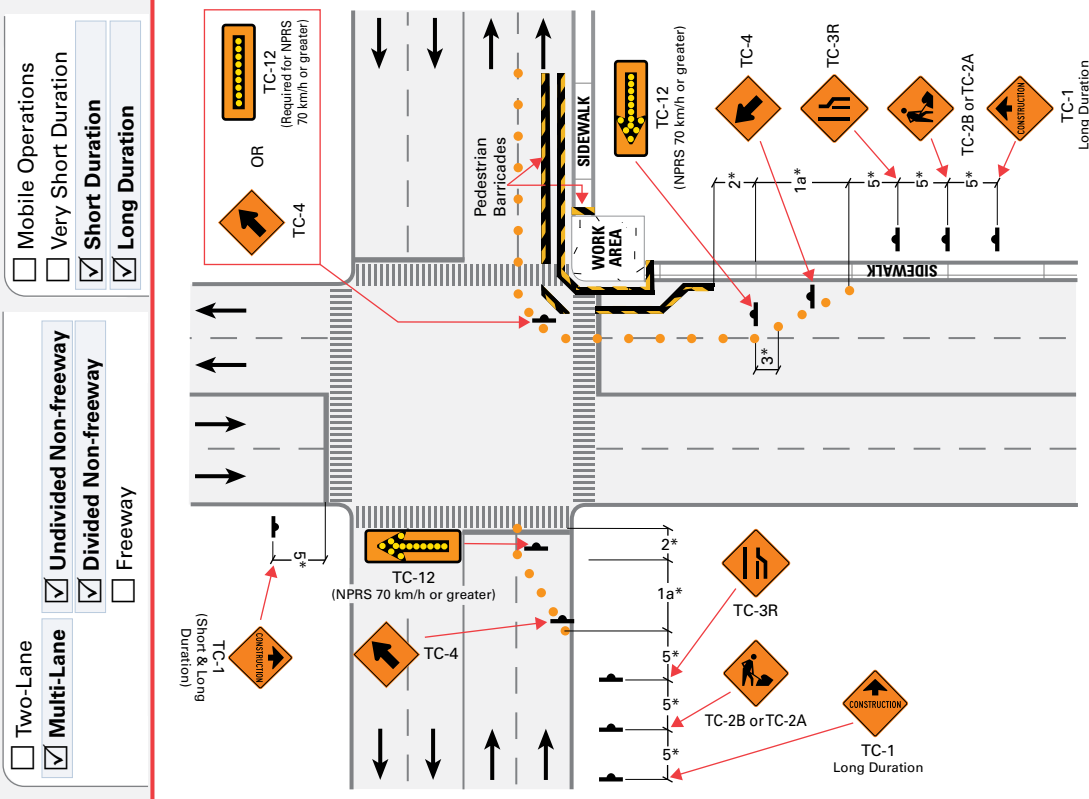

NOTES

- i) For Sidewalk Closures of Long Duration, a Boardwalk & Railing should be provided instead of Pedestrian Barricades.
- ii) Minimum Width of the Temporary Walkway is 1.2 m.

* For Short Duration, see [Table A](#). For Long Duration, see [Table B](#).

Figure TL-64 Pedestrian Accommodation: Mid-Block Sidewalk Detour onto Roadway

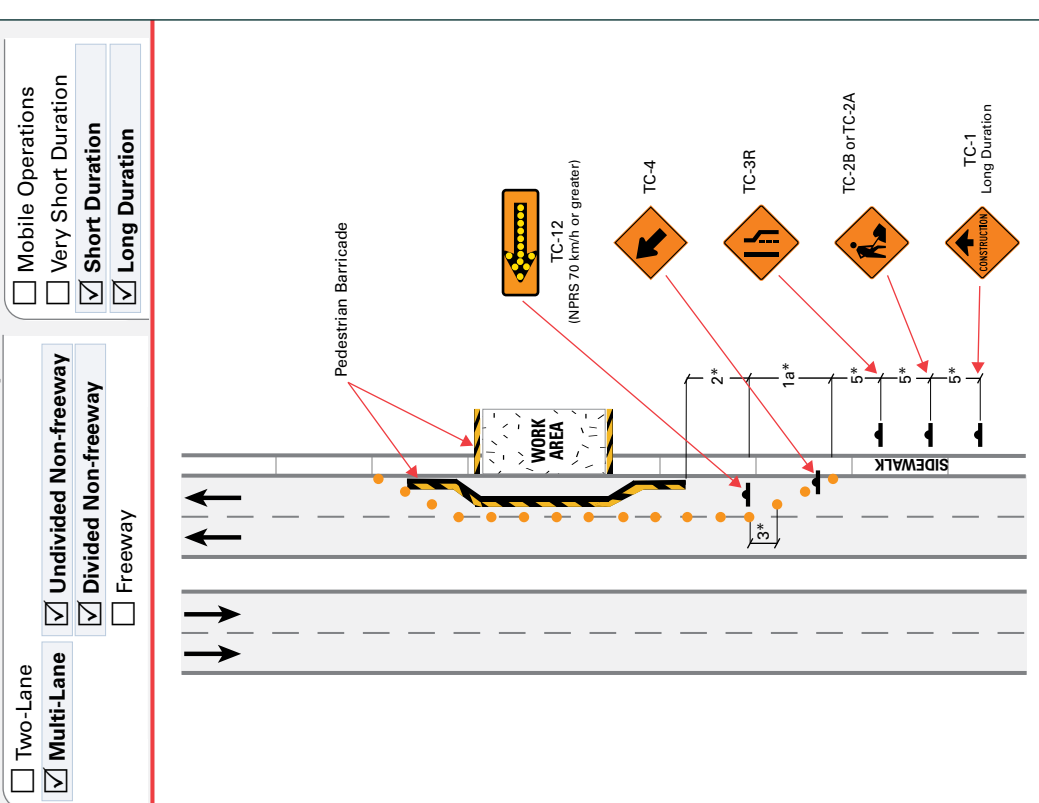

NOTES

- i) For Sidewalk Closures of Long Duration, a Boardwalk & Railing should be provided instead of Pedestrian Barricades.
- ii) If close to a Sidewalk, Pedestrians can be directed to the opposite side of the street with a TC-40 & TC-40t installed at the Crosswalk.
- iii) Minimum Width of the Temporary Walkway is 1.2 m.

* For Short Duration, see [Table A](#). For Long Duration, see [Table B](#).

Figure TL-67 Zone Painting (non-coning paint)

- Two-Lane
- Multi-Lane
- Undivided Non-freeway
- Divided Non-freeway
- Freeway
- Mobile Operations
- Very Short Duration
- Short Duration
- Long Duration

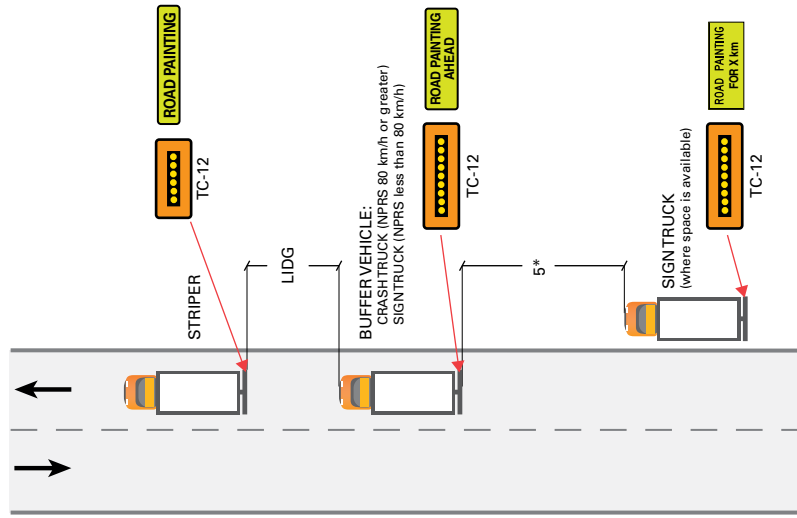

- NOTES**
- i) MTO requirements illustrated. Other Road Authorities may not require a BUFFER VEHICLE on Low Volume roads with NPRS less than 80 km/h. A BUFFER VEHICLE (Crash Truck or Sign Truck) must be used on High Volume roads and/or where the NPRS is 80 km/h or higher.
 - ii) Where shoulder is intermittent, SIGN TRUCK should turn off TC-12 and drive with Traffic Flow until shoulder becomes available.
 - iii) The distance between SIGN TRUCK and BUFFER VEHICLE may be adjusted to accommodate hills, curves, restricted visibility, or other specific conditions.
 - iv) Alternately the SIGN TRUCK on the shoulder may have a programmable VMS displaying approved message warning of line painting operations ahead.

Figure TL-66 Pedestrian Accommodation: Vehicle Encroachment on Road/Sidewalk

- Two-Lane
- Multi-Lane
- Undivided Non-freeway
- Divided Non-freeway
- Freeway
- Mobile Operations
- Very Short Duration
- Short Duration
- Long Duration

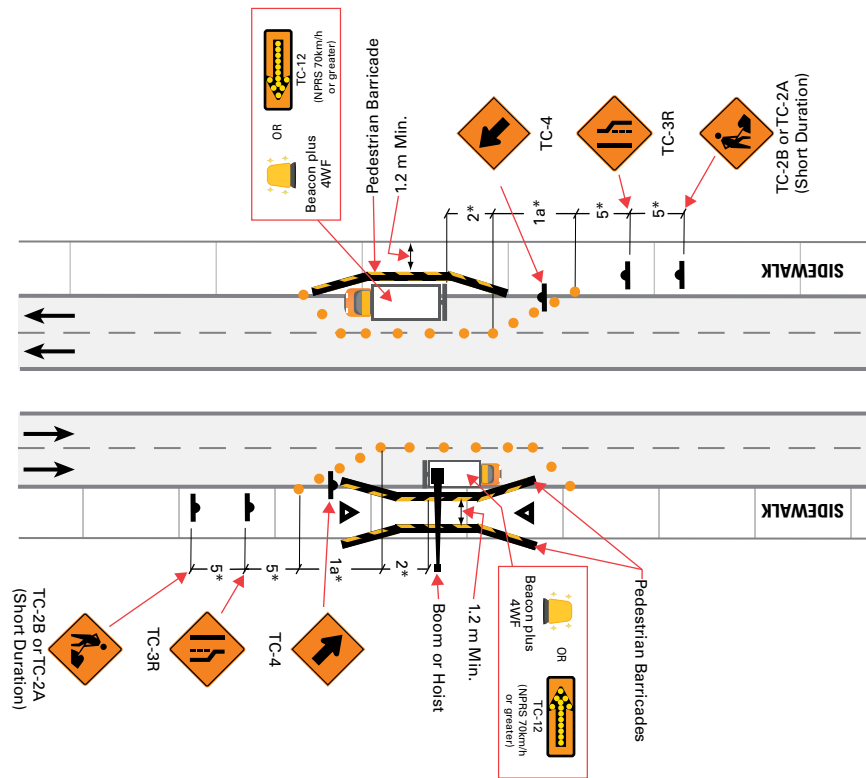

- NOTES**
- i) **▲** Location of Pedestrian Controllers if required (e.g. use of booms or hoists). Pedestrian passage under boom is acceptable when boom is not in motion and when hoisting is not underway. Where activities at a work area could endanger the public (e.g. trenches, excavation), pedestrian barricades must be used.

Figure TL-68 Zone Painting: Right or Left Lane Closed (non-coning paint)

Two-Lane
 Multi-Lane

Undivided Non-freeway
 Divided Non-freeway
 Freeway

Mobile Operations
 Very Short Duration
 Short Duration
 Long Duration

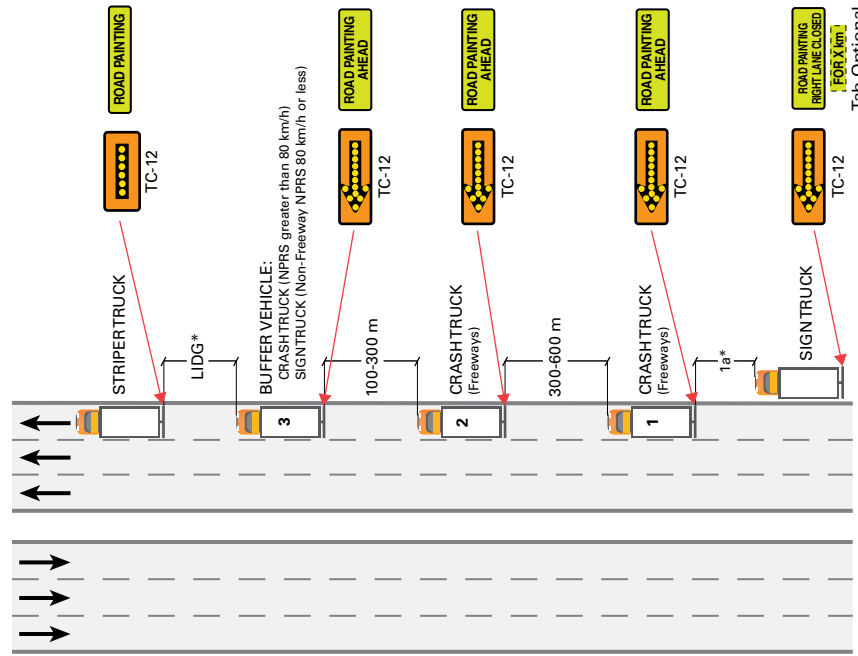

NOTES

* For Non-Freeways, see [Table A](#). For Freeways, see [Table C](#). For LIDG, see [Table D](#).

i) MTO requirements illustrated. Other Road Authorities may not require a "ROAD PAINTING" information signs or additional CRASH TRUCK #1.

ii) SIGN TRUCK may be replaced by an approved equivalent VMS.

iii) Left lane closed mirror image on multi-lane non-freeways where the SIGN TRUCK should follow on the same side shoulder as the closure. On freeways, or where no left shoulder is available the SIGN TRUCK must follow on the right shoulder with TC-12 in bar mode.

iv) The distance between SIGN TRUCK and BUFFER VEHICLE may be adjusted to accommodate hills, curves, restricted visibility, or other specific conditions.

Figure TL-69 Zone Painting: Intersection Turn Arrows

Two-Lane
 Multi-Lane

Undivided Non-freeway
 Divided Non-freeway
 Freeway

Mobile Operations
 Very Short Duration
 Short Duration
 Long Duration

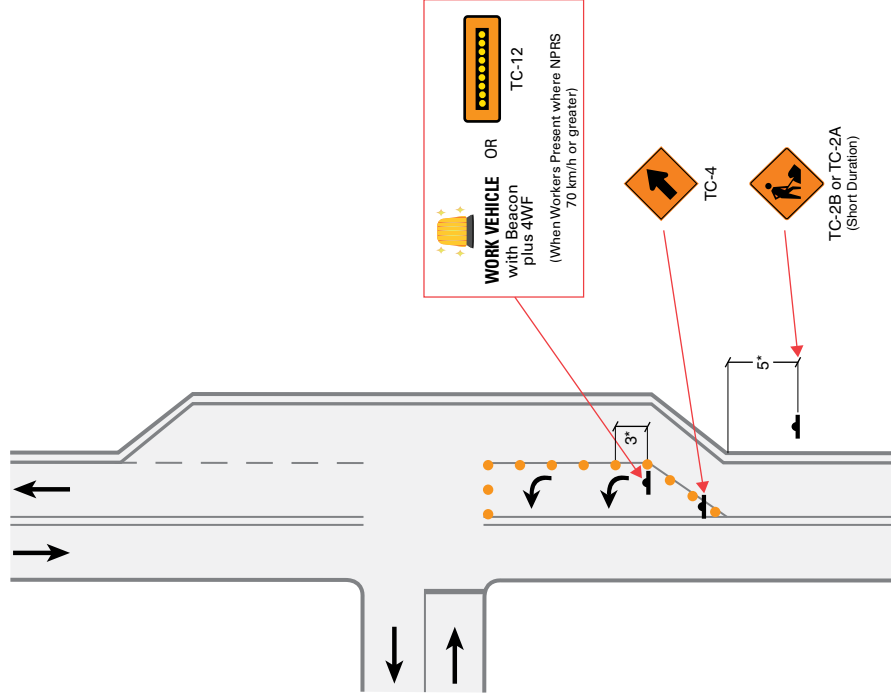

NOTES

* See [Table A](#).

i) Centerline Delineation required if workers present.

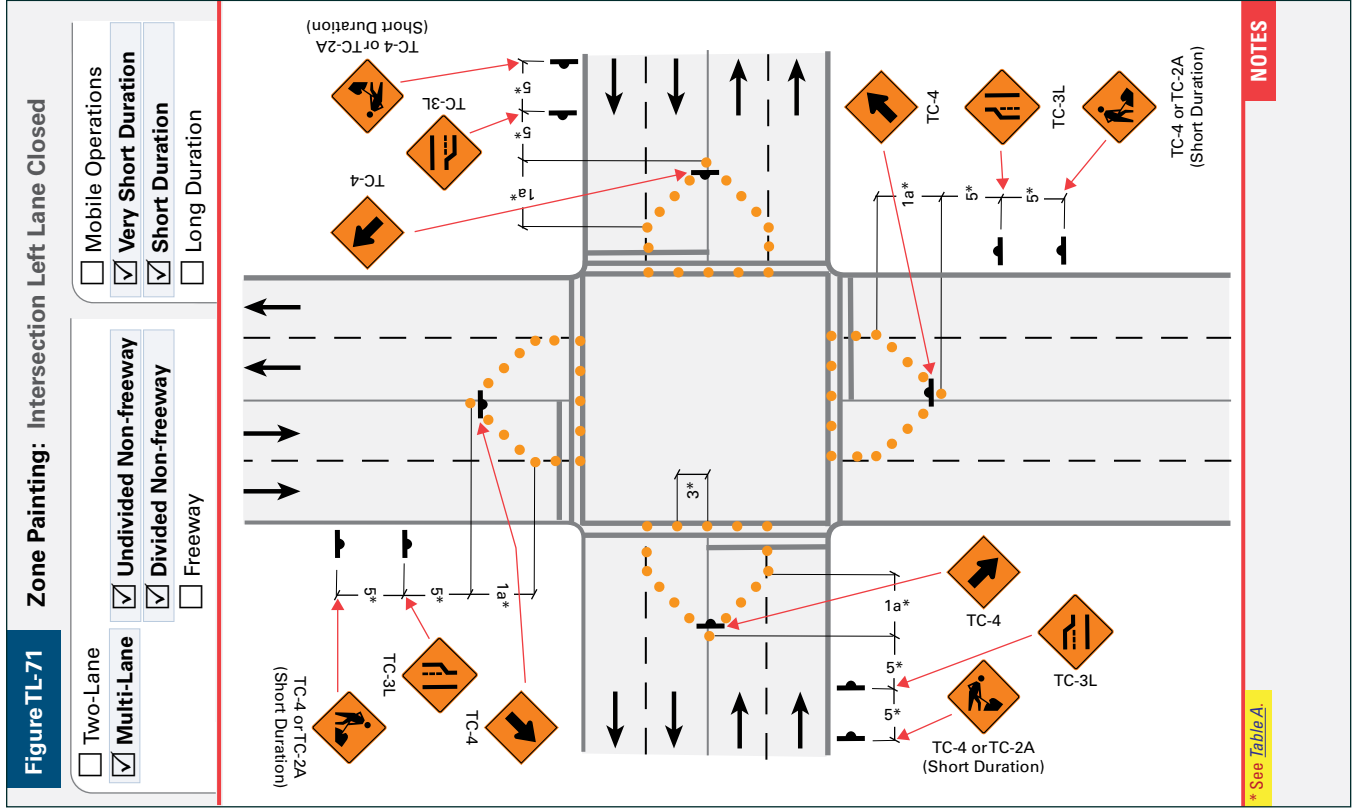
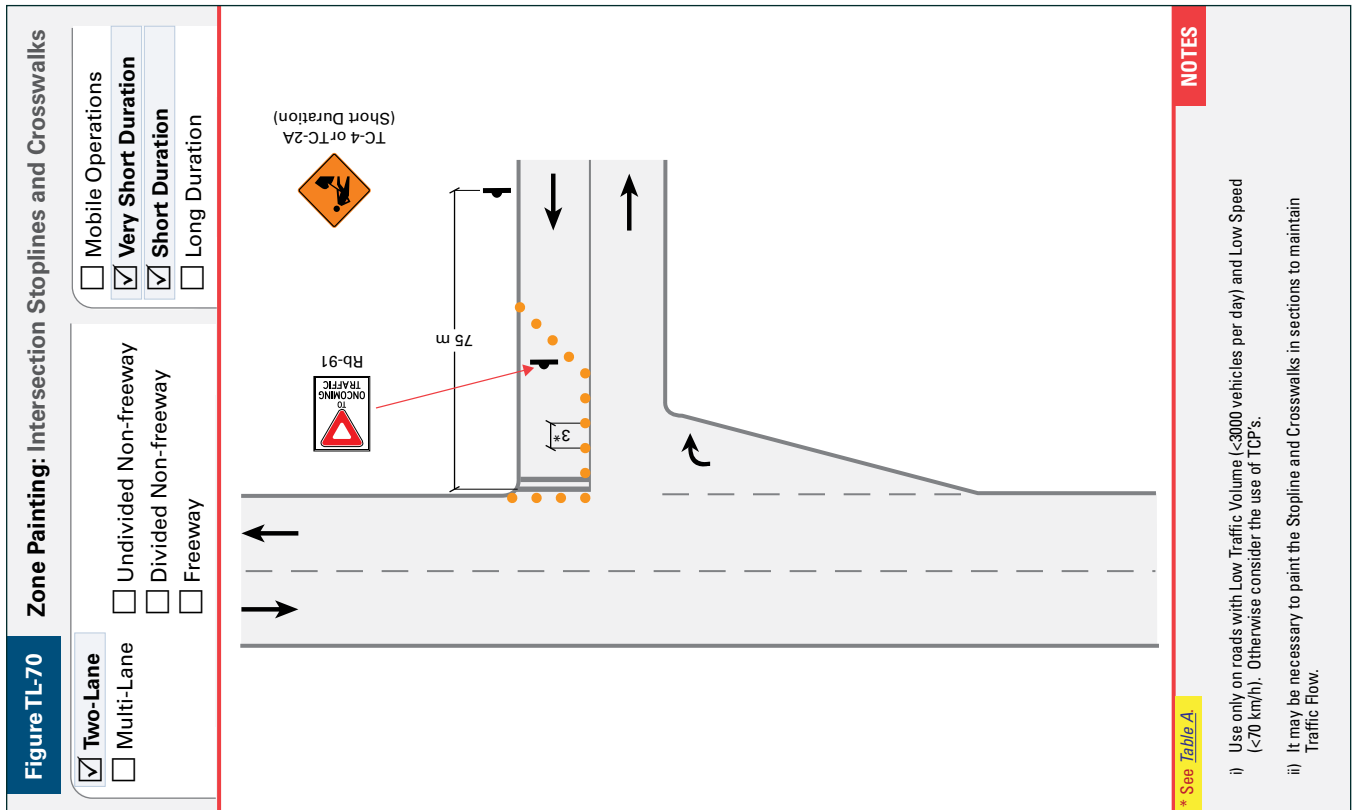
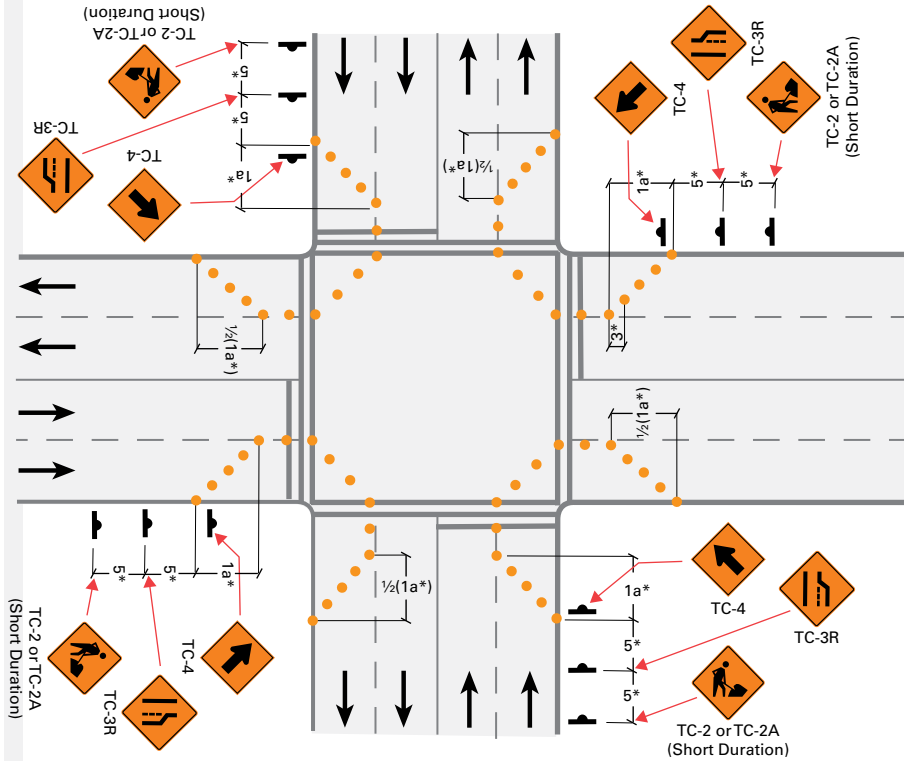

Figure TL-72 Zone Painting: Intersection Right Lane Closed

Two-Lane
 Multi-Lane
 Mobile Operations
 Undivided Non-freeway
 Divided Non-freeway
 Freeway
 Very Short Duration
 Short Duration
 Long Duration



NOTES

* See Table A

Figure TL-73B Intermittent Work

Two-Lane
 Multi-Lane
 Undivided Non-freeway
 Divided Non-freeway
 Freeway
 Mobile Operations
 Very Short Duration
 Short Duration
 Long Duration

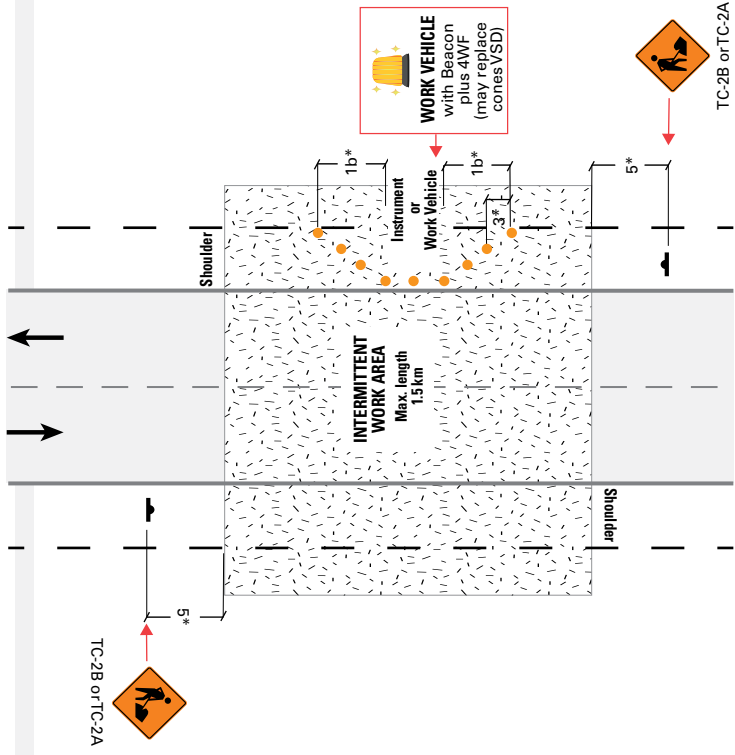

Where a worker/technician is moving throughout the intermittent work area with only brief stationary moments, for example a survey technician. A technician may intermittently and **MOMENTARILY (NOT CONTINUOUSLY)** enter the travelled lanes of the roadway **ONLY** if sight lines in both directions exceed 250m where NPRS is greater than 80km/h, 200m where the NPRS is between 60km/h and 80km/h or 150m where the NPRS is 60km/h or less. Any worker/technician/equipment that occupies the live lane continuously, whether moving or stationary, is considered very short or short duration and the appropriate typical layouts must be used. The duration of work equals continuous or total of intermittent work on shoulders.

NOTES

i) Termination taper optional.

ii) Work area may or may not contain a work vehicle. See General Notes to Typical Layouts #4.

iii) A work vehicle with a TC-12 may replace cones for VSD or SD work.

Figure TL-75

Intermittent Work: Intersection

Two-Lane
 Multi-Lane
 Undivided Non-freeway
 Divided Non-freeway
 Freeway

Mobile Operations
 Very Short Duration
 Short Duration
 Long Duration

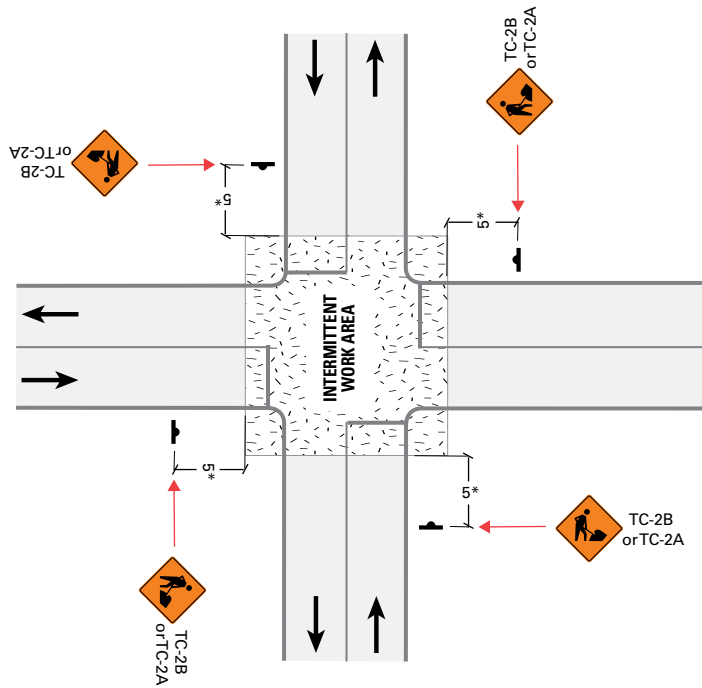

Where a worker/technician is moving throughout the intermittent work area with only brief stationary moments, for example a survey technician. A technician may intermittently and **MOMENTARILY** (NOT CONTINUOUSLY) enter the travelled lanes of the roadway **ONLY** if sight lines in both directions exceed 250m where NPRS is greater than 80km/h, 200m where the NPRS is between 60km/h and 80km/h or 150m where the NPRS is 60km/h or less. Any worker/technician/equipment that occupies the live lane continuously, whether moving or stationary, is considered very short or short duration and the appropriate typical layouts must be used. The duration of work equals continuous or total of intermittent work on shoulders.

- * See Table A. For LIDG*, see Table D.
- NOTES**
- i) Any equipment or work vehicles that continuously occupy the shoulder should comply with TL-5.

Figure TL-76

Intermittent Work

Two-Lane
 Multi-Lane
 Undivided Non-freeway
 Divided Non-freeway
 Freeway

Mobile Operations
 Very Short Duration
 Short Duration
 Long Duration

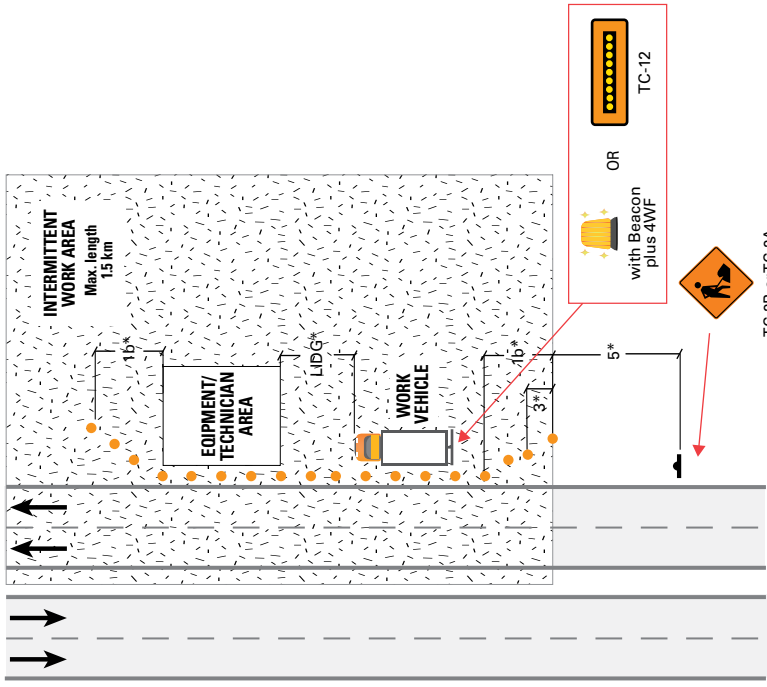

Where a worker/technician is moving throughout the intermittent work area with only brief stationary moments, for example a survey technician. A technician may intermittently and **MOMENTARILY** (NOT CONTINUOUSLY) enter the travelled lanes of the roadway **ONLY** if sight lines in both directions exceed 250m where NPRS is greater than 80km/h, 200m where the NPRS is between 60km/h and 80km/h or 150m where the NPRS is 60km/h or less. Any worker/technician/equipment that occupies the live lane continuously, whether moving or stationary, is considered very short or short duration and the appropriate typical layouts must be used. The duration of work equals continuous or total of intermittent work on shoulders.

- * See Table A. For LIDG*, see Table D.
- NOTES**
- i) Cones not required for Very Short Duration work.
 - ii) A work vehicle with a TC-12 may replace cones for Very Short or Short Duration work.

Figure TL- 86 Roundabout: Quadrant Closed (Traffic Control Persons)

| | |
|---|--|
| <input checked="" type="checkbox"/> Single-Lane | <input type="checkbox"/> Mobile Operations |
| <input type="checkbox"/> Multi-Lane | <input type="checkbox"/> Very Short Duration |
| <input type="checkbox"/> Undivided Non-freeway | <input checked="" type="checkbox"/> Short Duration |
| <input type="checkbox"/> Divided Non-freeway | <input checked="" type="checkbox"/> Long Duration |
| <input type="checkbox"/> Freeway | |

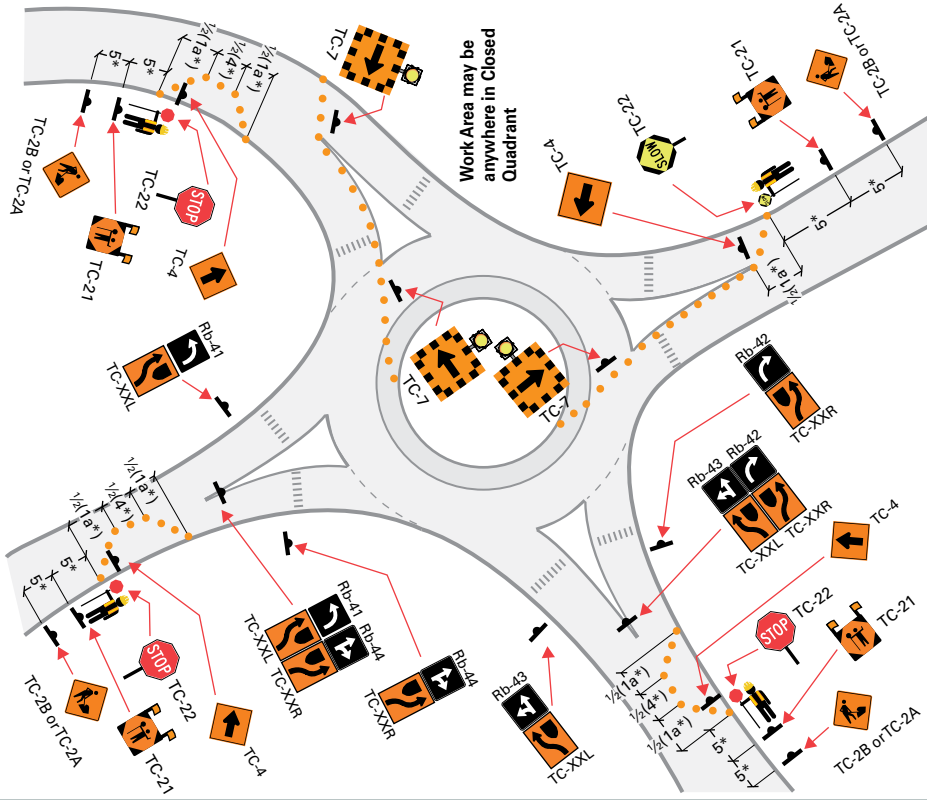

- NOTES**
- i) TCP's must be in communication with each other to ensure only one entrance has a TC-22 showing SLOW at any time.
 - ii) Roundabout must be cleared before next entrance has SLOW indication.
 - iii) For Long Duration a TC-1 is required 5* in advance of the TC-2 on each approach and for Long Duration with a NFRS 70 km/h or greater and/or Rural a TC-1A is also required.
 - iv) Use of AFADs or PLCS NOT permitted.

Figure TL- 85 Roundabout: Encroachment

| | |
|---|---|
| <input checked="" type="checkbox"/> Single-Lane | <input type="checkbox"/> Mobile Operations |
| <input checked="" type="checkbox"/> Multi-Lane | <input checked="" type="checkbox"/> Very Short Duration |
| <input type="checkbox"/> Undivided Non-freeway | <input checked="" type="checkbox"/> Short Duration |
| <input type="checkbox"/> Divided Non-freeway | <input checked="" type="checkbox"/> Long Duration |
| <input type="checkbox"/> Freeway | |

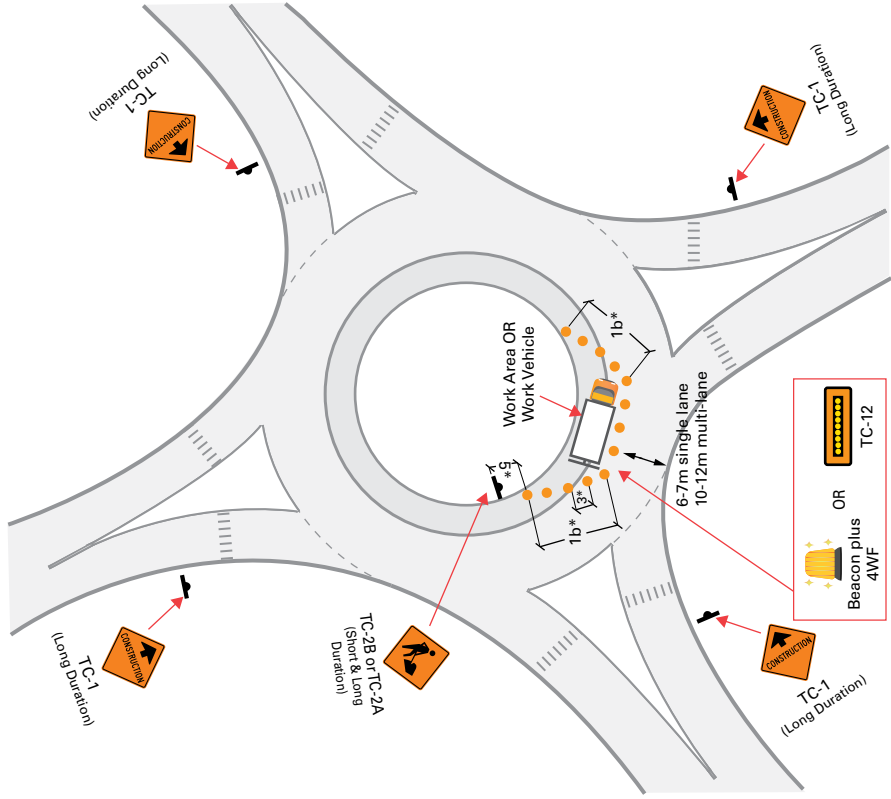

- NOTES**
- i) It may be necessary to leave a wider lane width if there is a high truck percentage.
 - ii) On Single-lane road, total width of 6 m must be maintained. On Multi-lane roads, total lane width of 10 m must be maintained. If minimum lane widths can not be maintained then see lane closure Tls.
 - iii) For Very Short Duration, Cones are not required if a Work Vehicle with Beacon/4WF or TC-12 is present.

Figure TL- 88 Roundabout: Inside Lane Closed

Single-Lane
 Multi-Lane

Undivided Non-freeway
 Divided Non-freeway
 Freeway

Mobile Operations
 Very Short Duration
 Short Duration
 Long Duration

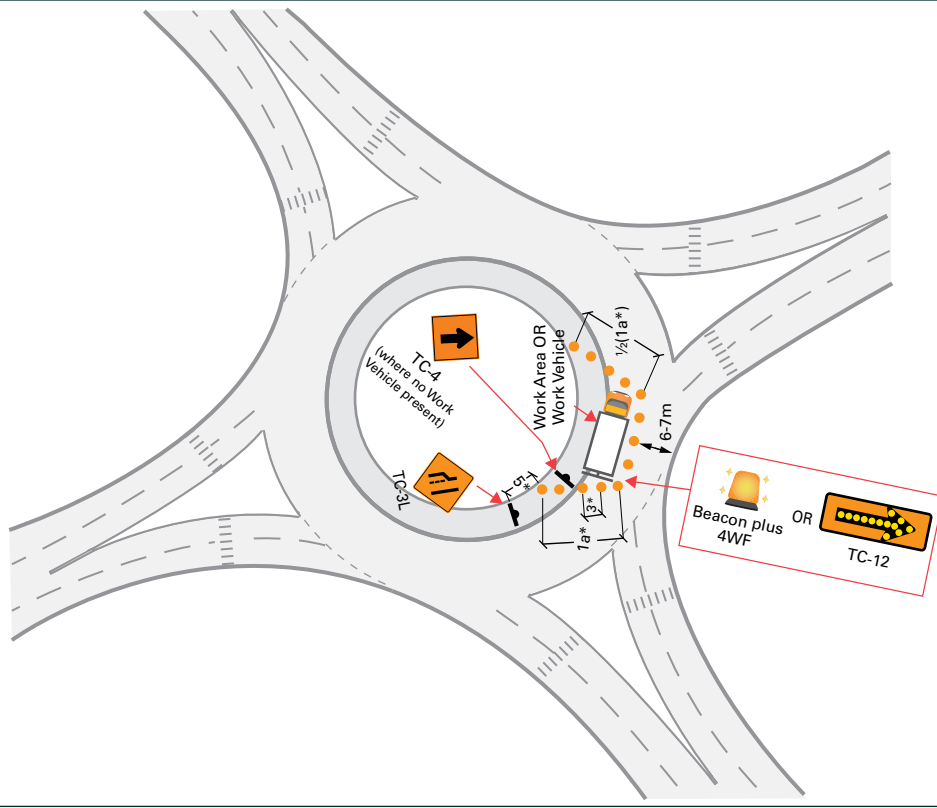

NOTES

* See [Table A](#).

i) It may be necessary to leave a wider lane width if there is a high truck percentage.

Figure TL- 87 Roundabout: One Exit Closed (Detour)

Single-Lane
 Multi-Lane

Undivided Non-freeway
 Divided Non-freeway
 Freeway

Mobile Operations
 Very Short Duration
 Short Duration
 Long Duration

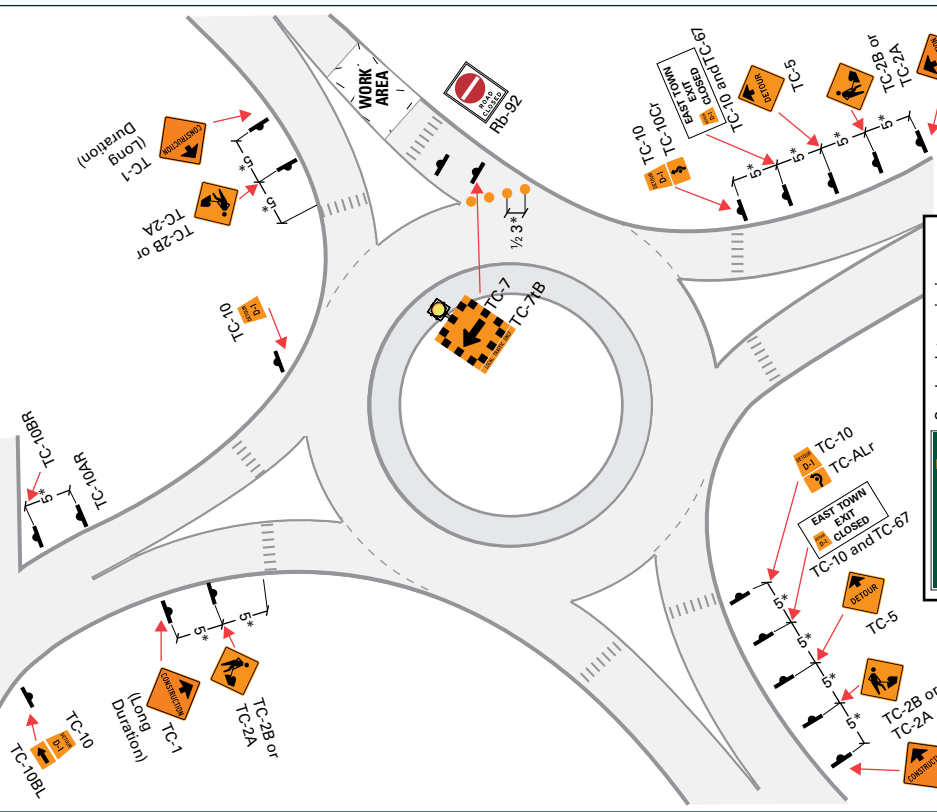

NOTES

* For Short Duration, see [Table A](#). For Long Duration, see [Table B](#).

i) See TL-42 for Detour signing in advance and beyond the Roundabout.

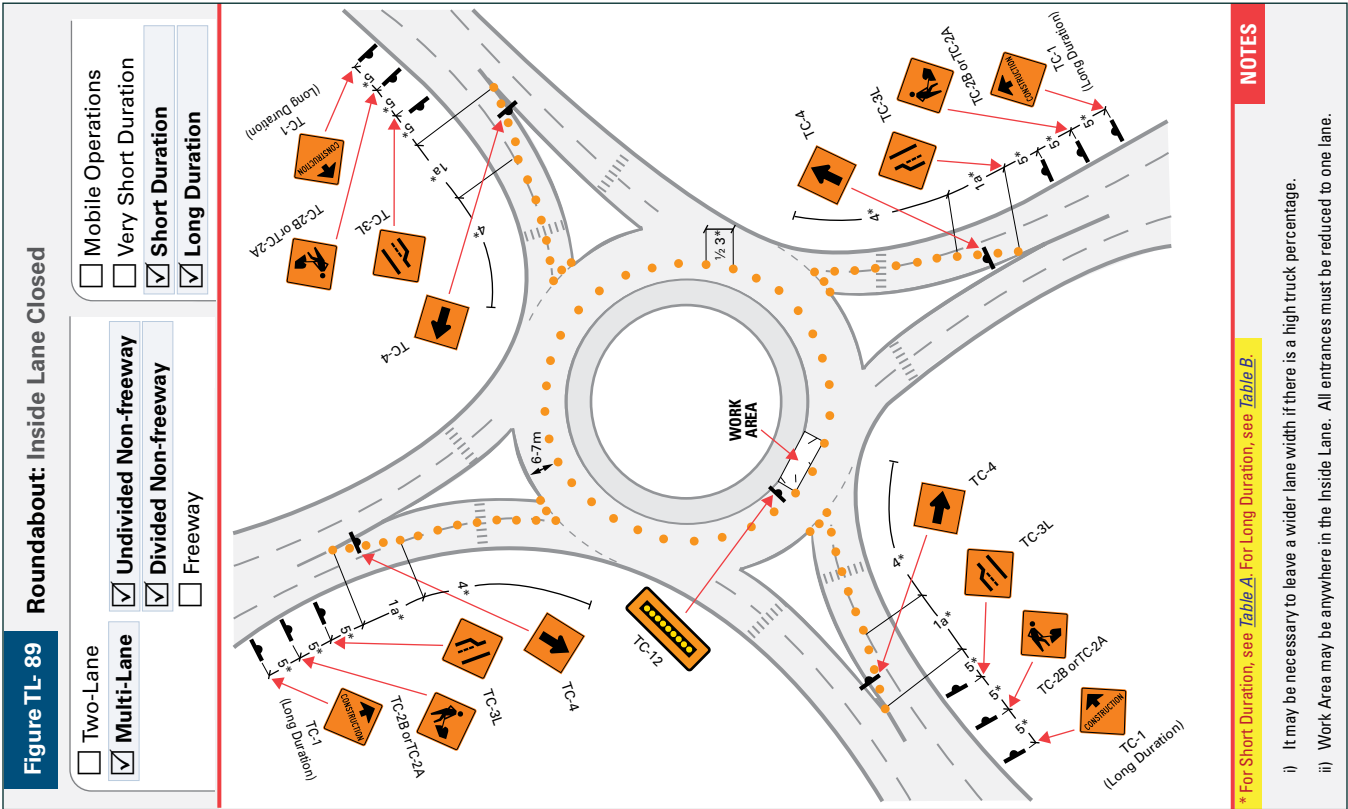
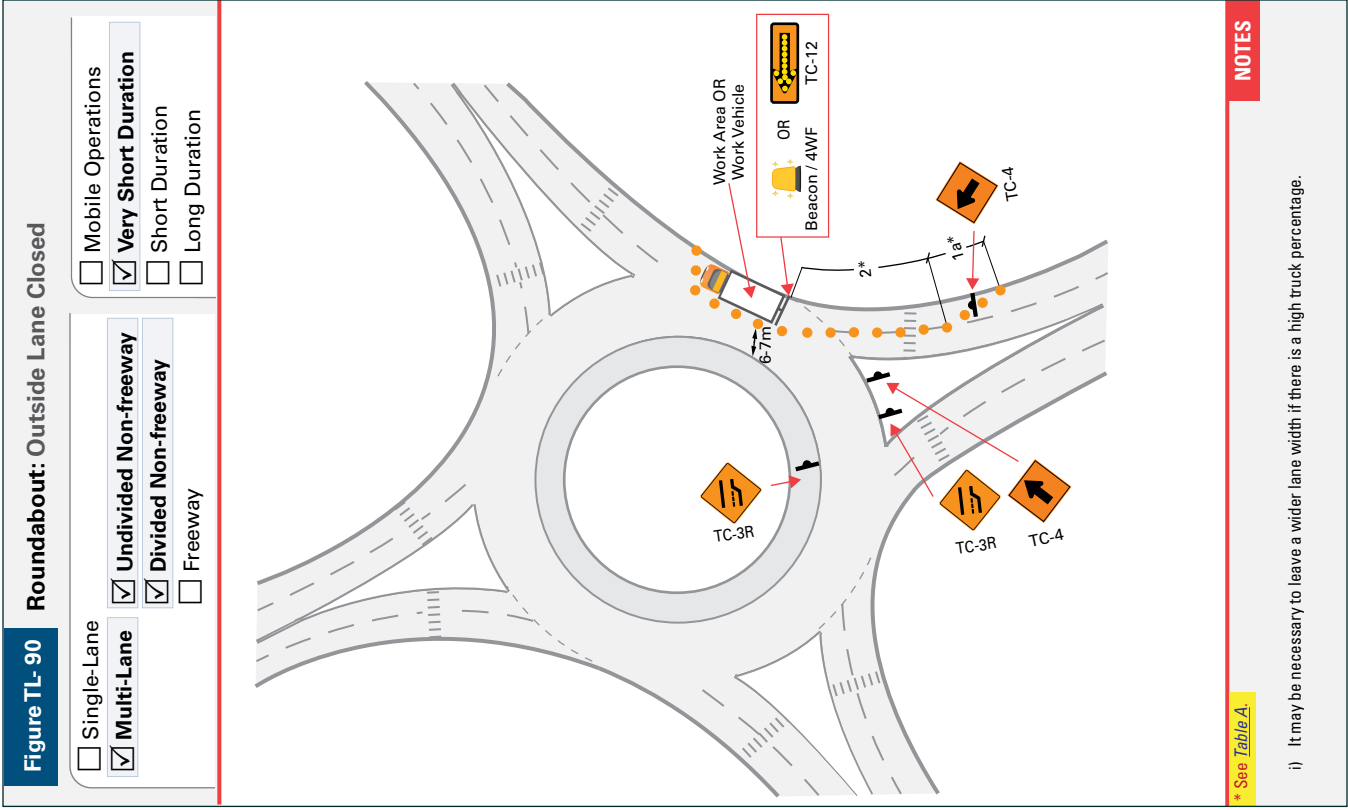
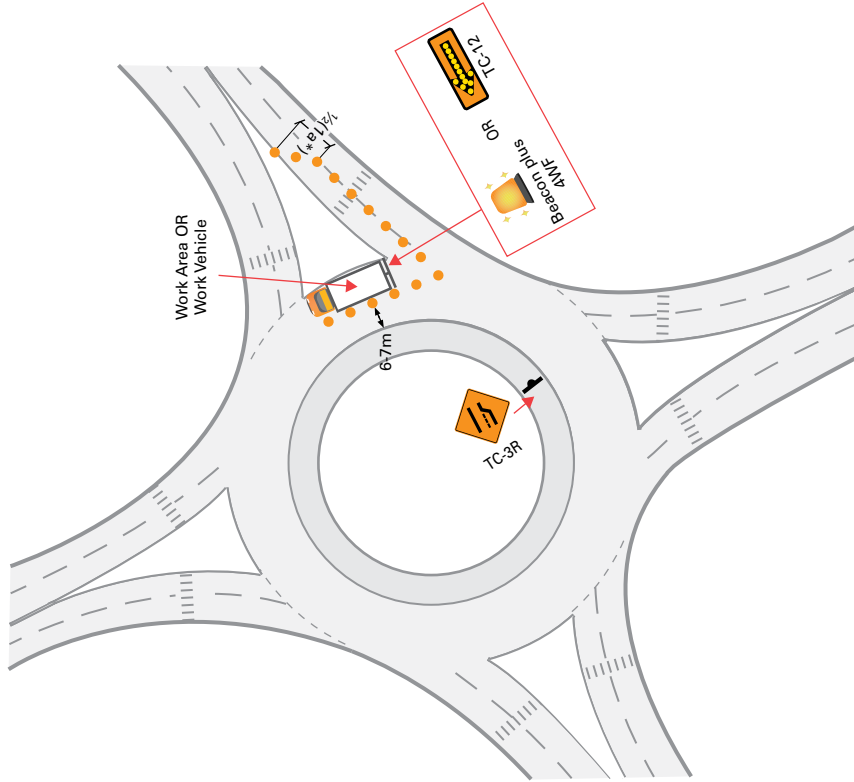

Figure TL-92 Roundabout: Outside Lane or Left Exit Closed at Island

| | |
|---|---|
| <input type="checkbox"/> Single-Lane | <input type="checkbox"/> Mobile Operations |
| <input checked="" type="checkbox"/> Multi-Lane | <input checked="" type="checkbox"/> Very Short Duration |
| <input checked="" type="checkbox"/> Undivided Non-freeway | <input type="checkbox"/> Short Duration |
| <input checked="" type="checkbox"/> Divided Non-freeway | <input type="checkbox"/> Long Duration |
| <input type="checkbox"/> Freeway | |



NOTES

* See Table A

i) It may be necessary to leave a wider lane width if there is a high truck percentage.

Figure TL-91 Roundabout: Outside Lane Closed

| | |
|---|--|
| <input type="checkbox"/> Two-Lane | <input type="checkbox"/> Mobile Operations |
| <input checked="" type="checkbox"/> Multi-Lane | <input type="checkbox"/> Very Short Duration |
| <input checked="" type="checkbox"/> Undivided Non-freeway | <input checked="" type="checkbox"/> Short Duration |
| <input checked="" type="checkbox"/> Divided Non-freeway | <input checked="" type="checkbox"/> Long Duration |
| <input type="checkbox"/> Freeway | |

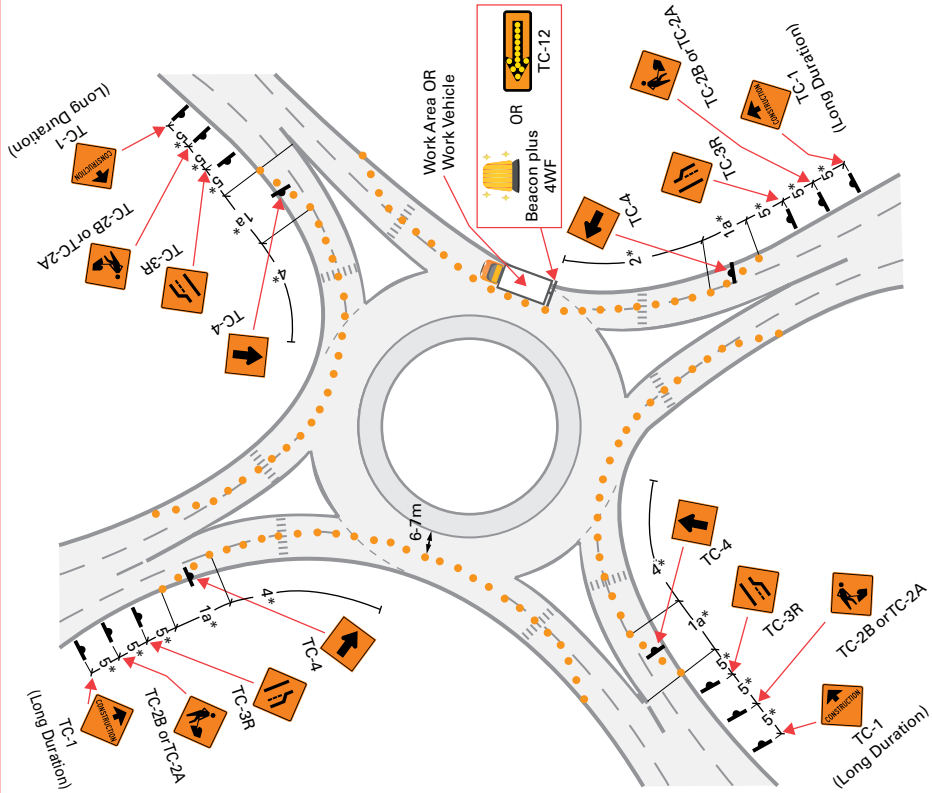

NOTES

* For Short Duration, see Table A. For Long Duration, see Table B.

i) It may be necessary to leave a wider lane width if there is a high truck percentage.

ii) Work Area may be in any of the Closed Quadrants. All entrances and exits must be reduced to one lane.

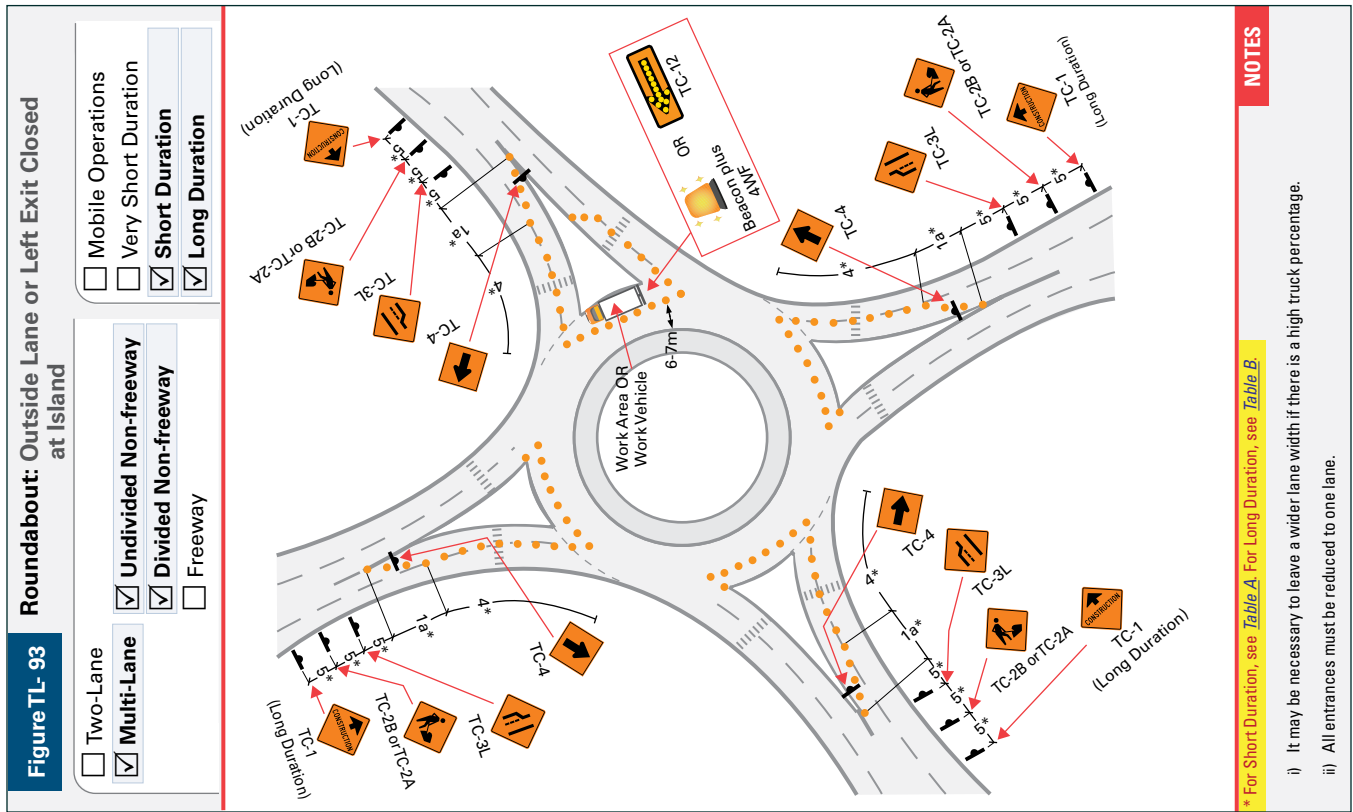

A1**Appendix 1: Temporary Traffic Control for Unplanned Events****A1-1****Introduction****A1-1.1****Scope**

Traffic control is one component of Incident Management at an unplanned event. It is the element that helps to secure the scene, protects other road users, and provides responders with the opportunity to safely deploy necessary actions.

This appendix provides guidelines to responders on recommended personal equipment, traffic control devices and progressive staging of traffic control with typical set up procedures. The information provided is directed toward operations personnel, and first and secondary responders who are responsible for establishing, maintaining, monitoring, modifying, and removing any traffic control at an incident scene or other unplanned event. The guidelines are based on Section 2 (Fundamental Principles of Traffic Control for Temporary Conditions) in this manual, OTM Book 7. Users should be familiar with both Appendix 1 and Section 2 as a reference. Table A1-1 identifies typical responders and their roles and responsibilities for traffic control.

Table A1-1 Typical Responders to Unplanned Events

| Response Agency | Roles and Responsibilities with regards to Traffic Control |
|--|---|
| 911 and Other Dispatchers | <ul style="list-style-type: none"> • Receive 911 calls from land lines, cell phones, and call boxes • Dispatch appropriate response agencies |
| Law Enforcement (Provincial, regional and municipal police departments) | <ul style="list-style-type: none"> • Assist in event detection and verification • Determine severity of incident and relay information to dispatchers • Isolate and secure event scene • Set up initial traffic control devices • Determine additional personnel/equipment needed to be called in • Supervise scene clearance • Direct traffic • Identify requirements for crash investigations |
| Fire Rescue (full-time, composite and volunteer fire departments) | <ul style="list-style-type: none"> • Protect and contain incident scene • Assist in direction of traffic • Provide initial hazardous material response and/or request additional clean-up resources • Assist in incident clearance |

| Response Agency | Roles and Responsibilities with regards to Traffic Control |
|--|---|
| Emergency Medical Services | <ul style="list-style-type: none"> • Protect and contain incident scene when first on scene • Determine destination and transportation requirements for the injured • Coordinate evacuation with firefighters, police, ambulance staff, or airlift personnel • Transport incident victims |
| Ministry of Transportation or Municipal Road Authority Personnel (or agent) – Maintenance | <ul style="list-style-type: none"> • Assist in incident detection and verification • Provide initial and longer-term traffic control • Provide special equipment or resources as requested • Contain minor spills if possible • Coordinate with law enforcement with regards to alternate routes • Coordinate personnel resources • Assess infrastructure damage |
| Ministry of Transportation or Municipal Road Authority Personnel (or agent) –Traffic Operations | <ul style="list-style-type: none"> • Assist in incident detection and verification, communicate with emergency services • Operate intelligent transportation system (ITS) devices per approved response plans • Provide traveler information to public and media • Dispatch service patrols • Notify other agencies of incident as required |
| Ministry of Transportation or Municipal Road Authority Personnel (or agent) – Construction | <ul style="list-style-type: none"> • Similar duties as maintenance personnel, but within a work zone • Coordinate with contractor for traffic control and repairs |
| Towing and Recovery | <ul style="list-style-type: none"> • Assist with incident detection and verification • Secure incident scene if no encroachment into live lane • Assist with and relocate disabled vehicles • Provide containment of minor spills • Clear the scene |

A1-1.2 Definition of Unplanned Events

Temporary traffic control for construction, maintenance or scheduled activities, although unique to each location, allows for planning, documentation and application of the fundamental principles detailed in OTM Book 7. An unplanned event refers to any incident that occurs without advance notice of time and location which disrupts normal traffic flow and/or presents a hazard to road users. An unplanned event requires prompt scene management by all responders.

Unplanned events include the following situations:

- unplanned infrastructure maintenance, such as watermain breaks, fallen poles or signs, bridge/road washout;
- vehicle(s)/road user collision, medical emergencies;
- vehicle breakdown/fires;
- debris on roadway - those from nature, objects, spills (including hazardous materials) ; and
- off roadway incidents that affect traffic.

A1-1.3 Traffic Control Guidelines

It is extremely difficult to establish a clearly defined traffic control zone under emergencies or other unplanned conditions, especially upon arrival. The securing of a scene takes time, and set up should be a progressive activity based on personnel, equipment, and the critical needs of the incident. On-scene traffic control needs can dynamically change as the response efforts progress. See [Table A1-2 Progression of Traffic Control](#).

The first priority upon arrival is to establish initial traffic control that provides a safe work area for responders and minimizes the chance of secondary crashes.

Traffic control device placement is impacted by the expected duration of the incident, location, prevailing traffic conditions (i.e., volume, speed), weather, and visibility. Upon arrival, responders should make an estimate of the magnitude of the incident and then estimate the expected duration for recovery. Traffic control can then be progressively established based on this estimate. A preferred sequence would be to go from:

1. full roadway closure, to
2. directional lane closure, to
3. multiple lanes, to
4. single lane, and to
5. shoulder closure until the incident is fully resolved and traffic flow returns to normal.

The initial closure should only be as required to ensure protection of the scene. For example, if only multiple lanes need to be closed, the progressive set up should start from point 3 above.

Roadway lane closure must be managed so that only the lanes that are absolutely necessary to protect the responders, victims, and investigation are closed. Every effort should be made to minimize the amount of time that these lanes are closed. The number of closed lanes may change several times during clearance efforts, so traffic control needs to be established and then monitored/changed to fit changing conditions.

As resources with traffic control devices/equipment arrive, traffic control should be adjusted to an OTM Book 7 compliant format.

Table A1-2 Progression of Traffic Control

| | |
|--|---|
| <p>Arrival</p> | <ol style="list-style-type: none"> 1. Ensure all emergency lights are operating as you approach the scene. 2. Conduct an initial scene survey to identify hazards and evaluate the situation. 3. At any incident where there is encroachment into a live traffic lane, only person(s) qualified under the Highway Traffic Act (HTA) can provide temporary traffic control. If not already present, the appropriate police agency and/or road authority shall be notified that traffic control is required. All other response vehicles shall park in a safe location until initial traffic control is established. 4. Begin the establishment of an emergency traffic control zone by slowly coming to a stop and positioning the emergency response vehicle to provide initial safety to the scene. 5. All personnel who leave emergency vehicles must wear appropriate safety equipment. |
| <p>Initial Set up</p> | <ol style="list-style-type: none"> 6. When practicable, place cones and/or flares to form an initial taper with devices on hand. 7. Position additional responder vehicles to enhance establishment of traffic control zone or direct to park in an appropriate location. 8. If required, call for additional resources to secure the scene (i.e. road authority, "safety support vehicle", additional traffic control devices, etc.). |
| <p>Enhanced Traffic Control</p> | <ol style="list-style-type: none"> 9. Place appropriate advisory signs in the advance warning area as soon as possible. 10. Expand taper and cone placements for road conditions and estimated on-scene time. 11. If required, utilize appropriate person(s) to direct traffic on non-freeways and other available traffic control devices. |
| <p>Ongoing Traffic Control</p> | <ol style="list-style-type: none"> 12. When an extended duration scene is anticipated, additional traffic control devices shall be provided as shown in OTM Book 7 for a planned event of the expected duration (short duration or long duration). 13. All safety procedures must remain in place until the incident is terminated (all personnel, hazards, emergency and related vehicles, and equipment are removed from the roadway). |

A1-1.4 Unified Command

Command needs to be established from the first arriving responder. The responsibility of the incident commander is to stabilize the environment, scene, and any patients before beginning operations. Depending on the availability of emergency responders, the typical first arriving responder may vary between jurisdictions. As well, the incident commander may change among the first responders as the incident progresses. For example:

1. The incident commander is more appropriately EMS when medical treatment is required for patients where no extrication is required and there is no risk of fire (or other safety hazards, but significant resources are required to transport the injured parties).
2. The incident commander is appropriately the fire department when extrication is required or there is risk of a fire.
3. The incident commander is appropriately the police when the patient has been stabilized or transported from the scene or the fire extinguished. The focus of command will change to expediting traffic flow (perimeter safety of all parties and expediting traffic flow).

It is recommended that the first responder organizations within a jurisdiction develop an incident command protocol.

A1-2 Guidelines for First on Scene

A1-2.1 Identification of Hazards and Scene Evaluation

The first responder to an unplanned event should conduct an initial scene survey to identify site specific hazards and evaluate the situation. Placement of vehicles and traffic control devices will be impacted by the unique conditions of each scene. The purpose of traffic control is to provide protection to the responders and guidance to the road users. Any potential hazards to responders or road users should be identified and traffic control accordingly adjusted. Hazards that affect traffic control may include:

- poor visibility due to weather;
- limited/obstructed sight lines – hills, curves, trees, signs, etc.;
- increased road user reaction time required due to road conditions – wet, icy, snow covered;
- impact of road type – gravel, paved, current surface conditions;
- prevailing traffic characteristics – observed speed, volume, % heavy vehicles;
- impacts from type or level of lighting – artificial illumination (night), sun direction, dusk/dawn; and
- estimated on-scene time.

A1-2.2 Estimated On-scene Time – Extended Duration Scene

The first responder to an unplanned event should make an estimate of the expected on-scene time and determine the adequacy of the resources on hand (vehicles, cones/flares, personnel) to maintain traffic control for the entire duration and various stages of the event. Additional resources should be requested as soon as practicable.

Extended duration scenes are typically traffic incidents that involve hazardous materials, fatal traffic crashes that involve numerous vehicles, and other natural or human-made disasters. These traffic incidents typically involve the closure of all or part of a roadway facility for a period that exceeds two hours.

Examples include:

- chain reaction crashes;
- crashes that require a significant medical response, coroner response, and/or crash reconstruction response (e.g. fatalities);
- incidents that involve advanced, prolonged environmental clean-up (e.g., incidents that involve hazardous materials);
- structural damage; and
- wild fires near the roadway.

If an extended duration scene is anticipated, additional equipment, vehicles, and personnel must be called in to provide temporary traffic control as per OTM Book 7.

A1-2.3 Lane Closure and Traffic Direction

Only the police, firefighters, or road authority are permitted under the HTA to close a live lane(s) and/or direct traffic. If first on scene, EMS responders should block lanes that have been effectively closed by the incident as required, to protect the incident area until additional responders arrive. At any incident where there is encroachment into a live traffic lane, if not already present, the appropriate police agency and/or road authority shall be notified that traffic control is required. All other response vehicles, such as service and/or tow vehicles shall park in a safe location until initial traffic control is established.

A1-3 Equipment and Devices

A1-3.1 High Visibility Safety Apparel

All employers must ensure that workers who are exposed to the hazards of passing traffic are wearing reflective clothing appropriate for the circumstances.

All emergency responders who set up/remove traffic control devices, direct traffic, or work within 3m of a live lane shall wear high visibility safety apparel (HVSA).

Canadian Standards Association (CSA) standard CSA Z96-09 provides recommendations for the selection of appropriate HVSA and sets out performance criteria for high visibility garments. In addition, to the CSA standard, the Regulation for Construction Projects specifies the type of reflective garment and stripes that must be worn by workers who may be exposed to vehicular traffic on a construction project.

Consistent with the general duty under section 25(2)(h) of the OHSA, employers are required to take every precaution reasonable in the circumstances to protect workers. Employers of emergency first responders engaged in various non-construction type activities e.g. police, fire, ambulance, are responsible for conducting an assessment of traffic hazards to determine which type of high visibility garments are appropriate.

The CSA Standard Z96-09, ANSI/ISEA 107-2010, or European National Standard EN-471 may be used in establishing reasonable performance criteria for high visibility garments to protect workers on a case-by-case basis. For emergency responders, it is recommended that Class 2 or 3 HVSA should be used, within the limitations of the equipment necessary to perform their duties.

For workplaces that fall under the definition of a construction project, the Regulation for Construction Projects (O. Reg. 213/91) sets out specific minimum requirements for high-visibility garments to protect workers exposed to traffic hazards in section 69.1:

Section 69.1 – workers who may be endangered by vehicular traffic must wear a garment that covers at least the upper body and has the prescribed features for background material, stripes, and fit, with a tear-away feature if the garment is a nylon vest. Vests must also have an adjustable fit.

This regulation does not specify the performance criteria (i.e., chromaticity/luminance) for the required background material, front and back stripes, or silver night-time stripes for arms, legs, or sides. However, the Canadian Standards Association (CSA) current standard for high visibility safety apparel includes performance criteria for three colours of background material (fluorescent or bright yellow-green, fluorescent, or bright red-orange and fluorescent or bright red) and for three colours of stripes (combined retro-reflective and fluorescent yellow-green, orange-red or red).

Notes:

Most Fire Fighter bunker gear does not meet the reflectivity performance requirements of the Canadian Standards Association (CSA) Standard Z96-09 High-Visibility Safety Apparel. Firefighter(s) who are controlling traffic by the use of traffic control stop or slow signs are required to wear high visibility safety apparel while performing this work.

Personnel working within a safe zone established by blocker apparatus or police do not require vests. Personnel wearing self contained breathing apparatus or other specialized PPE such as Hazmat suits do not require safety vests but must be protected within a safe zone established by blocker apparatus or police.

High Visibility garments that comply with the previous CSA Z96 standard are considered acceptable if in good condition, however, when old high visibility garments are replaced, they should be replaced with high visibility garments that meet the current CSA Z96-09 standard.

The Ontario Safe Workplace Associations; Public Services Health and Safety Association, the Infrastructure Health and Safety Association, Workplace Safety and Prevention Services, and Workplace Safety North may be able to assist workplace parties and raise awareness about the hazards associated with work activities on/near roads.

HSO - Health & Safety Ontario <http://www.healthandsafetyontario.ca/HSO/Home.aspx>

A1-3.2 Vehicle Lights and Flares

Flashing lights (red, white, amber, blue, and/or green) on emergency response vehicles are used to enhance the safety of response personnel and incident victims, and are essential in the initial response stage.

Warning light applications are being advanced with the development of light emitting diode technology and include relatively new features, such as wig-wag, oscillating, and strobe capabilities. Flashing lights, high-intensity rotating, flashing, oscillating, or strobe light systems, mounted outside as well as inside of emergency response vehicles, provide visibility and give immediate information to the travelling public of an emergency situation. Use of flashing lights must comply with the Highway Traffic Act (HTA).

However, too many warning lights can be confusing to drivers. Flashing lights should, therefore, be used with discipline and discretion to minimize the impact on traffic flow. As practicable, it is recommended that once good traffic control is established at the incident scene, their use should be reduced such that:

- only amber, rather than red/blue, warning lights remain on once full OTM Book 7 compliant traffic control is in place. If deemed necessary due to visibility issues, such as fog, red/blue lights may be continued;

- the number of lights be minimized to avoid creating glare for motorists and reduce “rubber necking” behaviour;
- no/minimal forward-facing (into oncoming traffic) emergency lighting is occurring. Emergency response vehicles should be capable of turning off headlights when the responder determines that it is necessary;
- emergency response vehicles should have day and night settings for vehicle lights; and
- tow vehicle beacons need to be deactivated once no longer needed to protect workers or public, i.e., after the vehicle is travelling with the traffic stream.

In addition to the use of emergency vehicle placement as an initial traffic control set up, the responders should carry enough emergency flares which can be used to set up a temporary lane closure taper until other efforts, such as traffic cones, can be placed. Flares, or other illuminated warning devices, are especially useful in night-time incidents to warn motorists of lane changes as the bright red lights of the flares tend to visually merge. They also can be used to supplement the visibility of traffic cone placement under night conditions. When the flares are placed near the cones, they not only warn upstream traffic, but the light also illuminates the cones. E-flares are a recommended alternative to “disposable” flares as they are not left at the scene.

A1-3.3 Emergency Signs

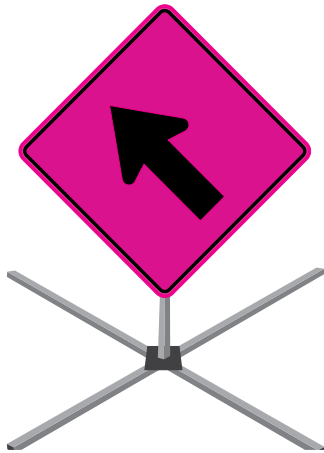

First responders may carry flexible, roll-up signs with the EMERGENCY SCENE AHEAD message or directional arrow that can be set up quickly by using portable lightweight spring stands or other appropriate temporary mounting at an incident site. The purpose of the signs is to alert drivers that the temporary traffic control is a result of an emergency situation, to expect responders on the roadway, and to proceed with caution as full temporary traffic control may not yet be established.

The EMERGENCY SCENE AHEAD sign should be placed on the shoulder of a roadway by a qualified first responder (fire, enforcement, or the road authority or their agent) in advance of the incident scene. At an unplanned event, responders have competing priorities, therefore, the following guidelines should be undertaken as practicable.



EMERGENCY SCENE AHEAD signs should be placed so that they will provide enough warning for vehicles to slow down before reaching the incident scene. The setting up of an advance warning sign for situations near a corner, hill, or other reduced visibility situations, may require the location of advance warning devices to be adjusted.

Incidents on high speed (over 80 km/h) divided roadways (freeways) should have warning signs placed, as practicable, approximately 160 m in advance of the beginning of the taper. Signs should be placed on the shoulder 2.0 m from the edge of the travelled lane.

Warning signs on other roadways should be placed approximately 20 m in advance of the taper for speeds 60 km/h or less and 70 m in advance of the taper for speeds above 60 km/h. Signs should be placed on the shoulder 0.3 to 2.0 m from the edge of the travelled lane.

The directional arrow sign should be placed by a qualified first responder (fire, enforcement, or the road authority or their agent) in advance of the incident scene, at the beginning of the taper where the road user is required to navigate around an incident.

Warning and guide signs used for the incident management of emergency traffic situations should have black lettering and a black border on a fluorescent pink background. The fluorescent pink background should be restricted to emergency warning signs only.

A1-3.4 Traffic Cones

Traffic cones are used as channelizing devices and to alert road users to hazards in or near the travelled way.

Cones should provide a smooth and gradual transition in moving traffic from one lane to another, into a detour, or in reducing the width of the travelled way. Channelizing devices may also be used to separate traffic from the incident area.

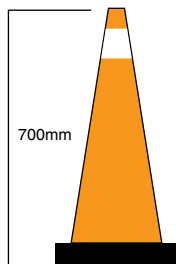

TC-51B

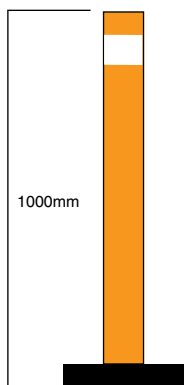

TC-51C

Where possible, they should be set 0.3 m to 0.6 m back from the edge of a live traffic lane. The standard cone is the TC-51B (700 mm) with a white reflective collar (the TC-51C with a white reflective collar is an acceptable alternative).

The white reflective cone collar must be 100 to 150 mm wide, mounted on the upper one-third of the cone taper, 100 mm below the top of the cone or marker (Type III or IV, high intensity reflective sheeting).

The TC-51A (450 mm) may be used when larger cones are not available; however, cones should have sufficient weight to withstand wind gusts in the environment that they are expected to be used in. Flashing beacons (visible 360°) or flares may be used in conjunction with cones to outline traffic set ups, especially the lateral buffer, and are highly recommended during low light and reduced visibility conditions.

On high speed freeways, lane closures should be accomplished with vehicles (that have appropriate lighting and arrow boards) rather than cones.

A1-3.5 Manual Traffic Direction

Manual traffic direction may need to be provided by qualified trained personnel (traffic control person (TCP)) during the initial phase of the response. Normally, the TCP is one of the responding law enforcement personnel, but could also be the fire or road authority (or agent). TCPs may be used to guide traffic when:

- speed limits are 90 km per hour or less,
- travel lanes are partially blocked,
- the shoulder must be used to pass by the incident, or
- only one lane is available for two way traffic.

It is important that the person who is directing traffic always faces the traffic, wears the appropriate HVSA, and directs traffic away from and safely around the incident by using large, extended, and consistent gestures to convey the required actions to drivers. Where available, STOP/SLOW paddles (TC-22) or a flashing light equipped with a small traffic direction cone are preferred for directing traffic. Refer to [Section 3](#) and [Section 4](#) in OTM Book 7 for more details on the procedures for manual traffic direction.

When resources permit, a traffic spotter may be utilized to monitor traffic and activate an emergency signal if the actions of a motorist do not conform to established traffic control measures in place at the incident scene. The use of a portable air horn or similar device is suggested as an emergency signal.

A1-3.6 Other Available Traffic Control Devices

Variable Message Signs

Variable message signs (VMSs), either portable or those permanently placed at critical major decision points of a road system, can be used to provide notice and information, such as lane changes and available alternate routes, as well as alert motorists to detour or expect delays in advance of the

incident. The earlier that the information can be provided means the greater the opportunity to reduce traffic demand at and approaching the scene as well as reduce motorist frustration. While the VMS text capability is limited as to the amount of information provided, this form of communication is very effective. Information relayed can include:

- specific incident location;
- expected incident duration;
- alternate route details; and
- diversion directions, including non-standard motorist actions (such as temporarily driving on the shoulder).

Arrow Panels

Arrow boards (TC-12 or TC-12A) are additional traffic control devices used where a lane(s) is closed and traffic must merge with other traffic in an adjacent lane. These devices will be brought to an incident scene at a later stage as full compliancy with temporary traffic control in OTM Book 7 is established.

Some road authorities and emergency responders are now mounting arrow boards on their work vehicles. These vehicle mounted boards can be used to provide guidance to the road user to support traffic control. Arrow boards should conform to the specifications for TC-12 or TC-12A as provided in [Section 5](#) to ensure visibility and consistent messaging. Arrow boards that do not comply with TC-12 or TC-12A should be considered only supplemental, with sufficient additional traffic control devices provided to guide the road user. Some of the devices have the capacity to not only display the arrows, but also text and other symbol messages. It is important that the responders receive training in the actual operational requirements of the arrow board as well as in the development of appropriate message sets to fully utilize the available board functions at the incident scene.

Crash Trucks

Heavy trucks, or trailers with rear-mounted energy adsorption attenuation equipment, become a traffic control device when parked to protect a work zone or incident area. The crash truck (CT) should be placed upstream from the incident work space with the wheels angled slightly away from the incident area and live traffic. It should not be occupied by anyone as its purpose is to protect the work area by taking any hit before an errant vehicle can enter the zone where people may be otherwise unprotected. The use of a CT must comply with [Section 5](#) in OTM Book 7.

Safety Support Vehicle

Risks increase on roadways with a posted speed of 70 km/h or greater. Therefore, on any roadway with a posted speed of 70 km/h or greater, a “support vehicle” should be dispatched along with the

primary response vehicles. A support vehicle can be any emergency vehicle; however, vehicles equipped with designated traffic control devices should be utilized first.

The support vehicle functions as a warning device to oncoming motorists by blocking a lane or parking on the shoulder. Personnel who operate a support vehicle may be required to:

- assist crews on scene;
- outline the perimeter of the incident scene or secure the site;
- set up any additional required safety equipment;
- establish traffic space and/monitor traffic flow; and
- block additional traffic lanes as required.

A1-4 Placement of Cones/Flares

Figure A1-1 Placement of Cones/Flares

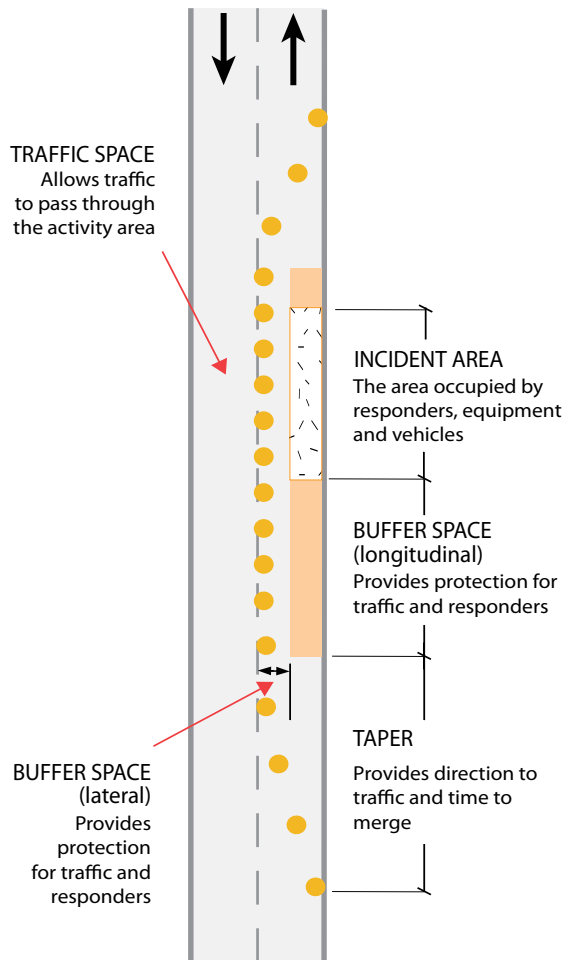

Taper

A taper, through the use of traffic cones/flares, should be set up as soon as practically possible at any time that there is a lane closure and/or traffic is moved from one lane to another. Walking a straight line taper can be both difficult and dangerous. Exposure to traffic flow is almost certain. Whenever resources permit, a spotter should be present to assist in watching for traffic during taper set up. Personnel should place and retrieve cones/flares while facing oncoming traffic.

The speed of the roadway should be considered when determining the length of a taper. Typically, a higher roadway speed means the need for a longer taper. However, initial scene set up is dynamic in nature and it is recognized that a balance must be reached between the roadway speed and the number of available cones/flares. For example, if the first responder on scene only has 6 cones/flares available when responding to an incident on a higher speed roadway, they will be only able

to set up a short taper; however, ***any taper is better than no taper***. A short taper should be extended as soon as resources permit.

It is recommended that emergency responder vehicles be equipped with, at a minimum, six to eight traffic cones/flares that comply with OTM Book 7.

Key points to remember when setting up a taper include:

- A taper should encompass all equipment on the scene.
- Tapers should be set up to accommodate for sight obstacles.
- The taper should end at the upstream end of the longitudinal buffer space.
- Maximize the space covered with the cones/flares available.
- Block as much of the roadway as needed and extend the taper out as far as possible to allow drivers adequate time to merge.

Buffer Space (Longitudinal)

When setting up cones/flares, a longitudinal buffer area that is free of vehicles, equipment, and people, should be provided between the end of the taper and the actual incident area. Cones/flares should be placed along the edge of a buffer area, defining a clear boundary between the traffic and the buffer area.

Incident Area

The incident area is the section of the highway where response activities take place. Cones/flares should be placed along the edge of an incident area, starting at the end of the buffer area. This will help to define a clear boundary between the traffic space and the activity area.

When required, also provide lateral buffer space. This is a clear area between the incident itself and the path of travelling vehicles. Lateral buffer space is beneficial because it allows room for responders to work. The amount of lateral buffer space to be used is dependent on many conditions, including, but not limited to, time of day, weather, and road conditions. Lateral buffer space can encompass partial lanes or an entire lane (i.e., the amount of area necessary to properly perform duties).

Conditions that affect Cone Placement

Cone placement should be adjusted (i.e. tapers lengthened, cones enhanced by flares) to account for the following:

Maximum Posted Speed

Roadway speed affects warning device placement due to:

- the distance travelled while reacting to the perceived hazard. A vehicle that is travelling at 100 km/h is covering about 28 metres (91') per second. Therefore higher speeds require longer advanced warning/visibility and tapers.
- the distance required to stop the vehicle after the brakes have been applied. Therefore higher speeds require a longer buffer space and taper.

View Obstructions

Obstacles can keep a driver from seeing the cones/flares, control devices, or hazards. View obstructions are not the same as reduced visibility. In reduced visibility, the object gradually becomes visible.

- Horizontal view obstructions - embankments, hedges, trees, buildings, vehicles, etc.
- Vertical view obstructions - crests of hills, bridges, and overpasses affect the sight distance or the line of sight of drivers.

Reduced Visibility

Weather and darkness do not obscure a view in the same way as solid objects, but they reduce visibility. They lessen the distance at which you can see things. Some examples are:

- darkness - lack of lighting or over-driving headlights, and
- weather - fog, smoke, rain, snow, or any combination of these. Darkness and weather may combine to further reduce visibility. The motorist frequently drives too fast for conditions present.

Glare

Glare temporarily blinds the field of vision of a motorist.

- Headlight glare - only at night, from oncoming traffic.
- Fixed light glare - back lighting, signs, and stationary vehicles.
- Sun glare - sun glare may make objects invisible to the motorist.

Other factors

- Motorist confusion between existing traffic control devices, signals, or pavement markings and emergency traffic control devices.
- Any change in alignment of a straight and level road (i.e., elevation, curve, embankment, sudden changes in road width, on-ramps, off-ramps, or intersections).

A1-5 Positioning of Emergency Response Vehicles

Emergency vehicles may be parked in such a way that they protect incident responders and secure the scene by directing traffic before additional traffic control devices arrive. Emergency vehicles should not unnecessarily impede traffic. Emergency vehicles should only block lanes as needed to work safely and efficiently, and should return the roadway to normal traffic flow as quickly as possible. Preferably, all emergency vehicles should be parked on the same side of a roadway, in the same direction of the incident.

The fend-off position is the recommended method for positioning the first emergency vehicle at an incident to provide added protection to the scene from traffic. This position gives approaching motorists the best visibility of the emergency vehicle's side while allowing them to recognize the incident. The vehicle is positioned at an angle adequate to protect the incident. This position may also deflect any high speed impact that would otherwise crash into the scene. The vehicle should be positioned to provide both a longitudinal and a lateral buffer space. Subsequent blocker trucks or crash trucks that arrive on scene should park upstream in accordance with Section 5.5 – Implementation of Buffer Vehicles.

Vehicles that do not protect the scene or responders should be staged in a safe area. Their location should not create a traffic hazard or obstruction, or impede other emergency vehicles.

Figure A1-2 Longitudinal and Lateral Buffer Space

It is recommended that a buffer space be established between the incident scene and emergency vehicles. The suggested distance is 4.0 m for every 10 km/h of posted roadway speed. Reasons for this

include:

- If the emergency vehicle is hit from behind, it may not be pushed into the original incident.
- Apparatus remains functional for firefighting operations.
- Scene preservation (crews will not drive inside the collision scene and destroy evidence).

Cones/flares can be used to close off the buffer space to vehicular traffic by placing them along the lane pavement markings

Lateral Buffer Space

Position the front and/or back bumper of the emergency vehicle at least 0.3 m from the pavement markings of an open live lane. This lateral buffer is used to reduce encroachment into the designated traffic lanes. Traffic cones/flares should be also placed on the skip line beside the emergency vehicle.

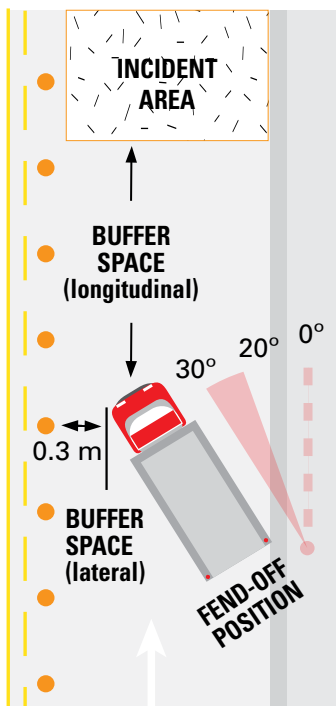

A1-6 Situations that Require Special Attention

Traffic Control at Rail Crossings

Traffic control at any railway crossing is controlled by rail crossing signs/signals. First responders can neither stop the train nor control their signals. If an incident affects rail traffic movement or presents a hazard anywhere along the railway right of way, contact dispatch or the appropriate railway police authority (i.e., CNR police) and have the trains stopped until the hazard has been removed or stabilized.

- Traffic control must be provided to prevent vehicles from stopping on railway tracks.
- Do not stop or park on the railway right of way.
- No traffic control devices are to be used on the railway right of way.

NOTE: Each emergency agency should be familiar with contacting the appropriate railway operator within their jurisdiction.

Traffic Control on High-Speed Highways

High speed highways present special problems for emergency traffic control. Moving vehicles should always be considered a threat to safety. When working on high speed highways, extra care must be taken to ensure visibility and minimize exposure. Personnel should not remain in or position themselves beside vehicles that are closing a traffic lane. All lane closures should start from the nearest shoulder to the incident site and extend across as many lanes as required, separately closing each lane. Where possible lane closures should be accomplished with vehicles instead of cones or flares.

Some incident scenes will be located at the end of a curve or near the top of a crest. In these situations, lane closures must be completed well in advance of the view obstruction to provide oncoming motorists with adequate warning. On high speed highways, additional advance warning devices may also be required on the approach to the lane closures.

Encroachment into Incident Space During Traffic Control Operations

Traffic direction personnel are trained to operate, whenever possible, off the travelled portion of a highway. In case of emergencies, they are to use their planned escape route for oncoming traffic incidents. When safe to do so, they are to return to their assigned position and let other emergency responders handle the new emergency as required.

A1-7 Progression of Traffic Control

The following illustrations present the progression of traffic control for various scenarios as a guideline to first and secondary responders.

Figure A1-3 Incident on Shoulder (Non-freeway)

Figure A1-4 Incident on Shoulder (Freeway)

Figure A1-5 Incident in Live Lane (Two-Lane Road)

Figure A1-6 Incident in Live Lane (Multi-Lane Non-Freeway)

Figure A1-7 Incident in Live Lane (Freeway)









| Legend | |
|---|---|
| Symbol | Description |
|  | Traffic Control Devices TC-51, TC-52, TC-54 or flares |
|  | Traffic Control Person (Fire, Police) |
|  | Work Vehicle, Sign Truck, Blocker Truck, Crash Truck or Service Vehicle |
|  Beacon / 4WF | Vehicle Four way Flashers and 360° Beacon (4WF/360° Beacon) |
|  | Incident Area |
|  | TC-12 Arrow Mode |
|  | TC-12 Bar Mode |
|  | Emergency Scene Ahead Sign |
|  | Emergency Response Vehicle (Fire, Police or EMS) |

Figure A1-3 Incident on Shoulder (Non-freeway)

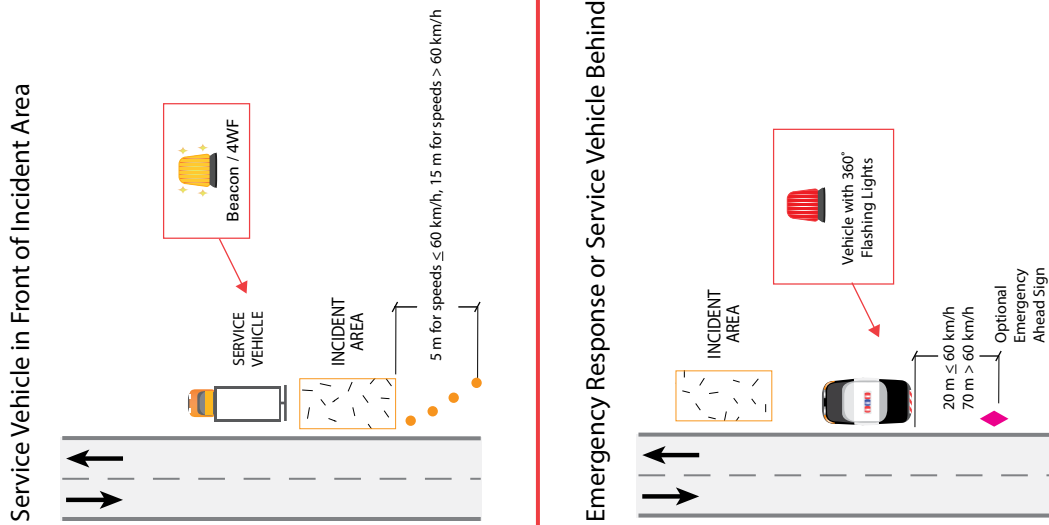

Figure A1-4 Incident on Shoulder (Freeway)

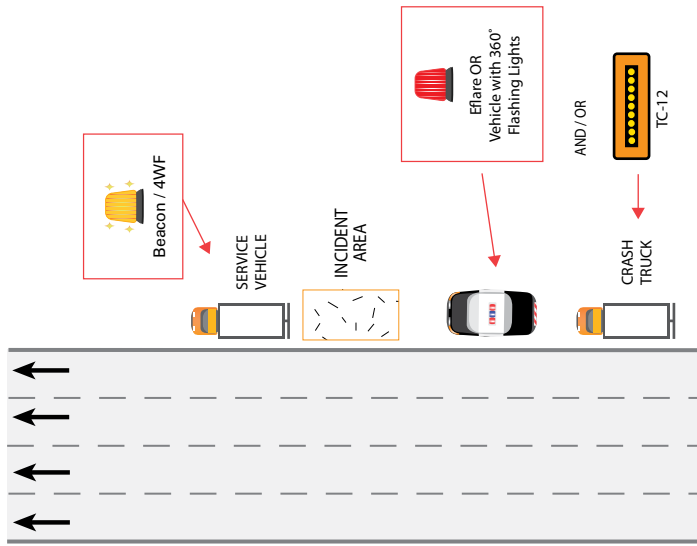

Figure A1-5 Incident in Live Lane (Two-Lane Road)

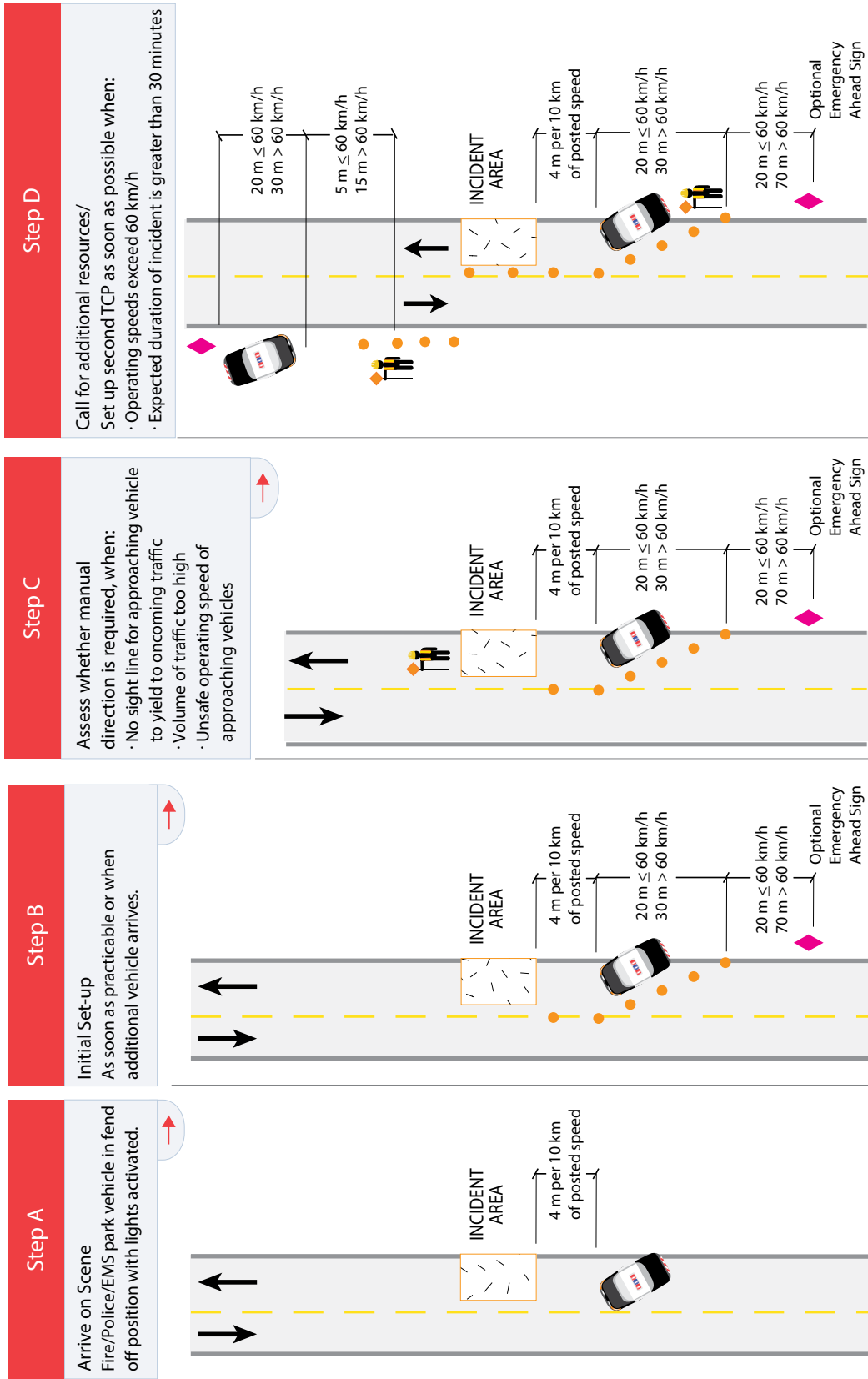
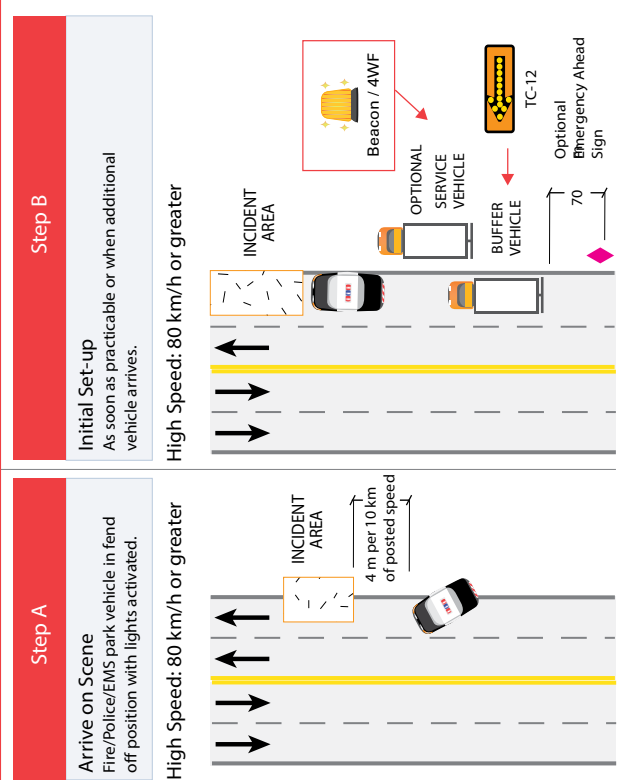
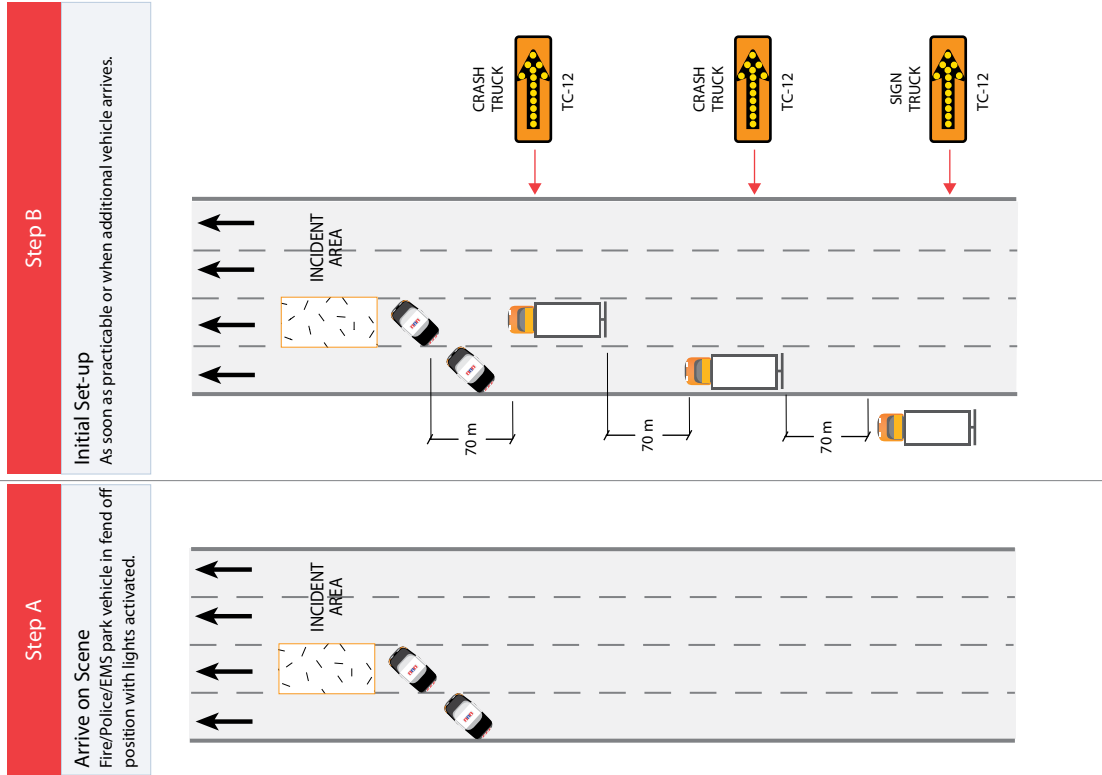
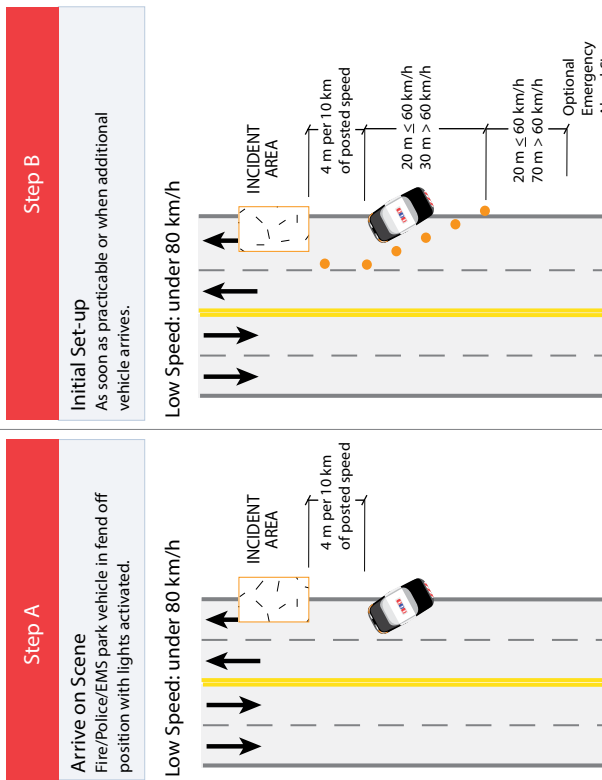

Figure A1-6 Incident in Live Lane (Multi-Lane Non-Freeway) **Figure A1-7 Incident in Live Lane (Freeway)**



A2**Appendix 2: Glossary****360 Degree Beacon**

A 360 degree beacon is a device with an intensely directed light source that continuously shows the light source thru all 360 degrees of the compass. This device must complete a full rotation every 1.5 seconds.

A**AADT**

Annual average daily traffic

Acceleration Lane

A speed change lane for the purpose of:

1. enabling a vehicle that is entering a roadway to increase its speed to a rate at which it can more safely merge with through traffic;
2. providing the necessary merging distance; and
3. giving necessary time to the main road traffic to make appropriate adjustments.

Advance Warning Area

The first component of a work zone, upstream of the approach area, used to alert drivers to road work ahead.

Advisory Speed

The speed, determined to the nearest 5 km/h, at which traffic may safely negotiate a potential hazard under favourable driving conditions.

All-red Interval Signal (Traffic Signal)

The time in seconds of a red indication for all intersection traffic. It is used following an amber clearance interval to permit vehicles or pedestrians to clear the intersection before conflicting traffic receives a green indication. In temporary conditions, the all-red interval is used to clear a one-lane section through a work site before opposing traffic receives a green indication.

Amber Clearance Interval (Traffic Signal)

The clearance interval in which the signal indication for that phase is amber. A clearance interval to warn approaching traffic to clear the intersection before conflicting traffic receives a green indication.

Annual Average Daily Traffic (AADT)

The total yearly traffic volume on a given road divided by the number of days in the year.

Approach Area

The second component of a work zone, downstream of the advance warning area, and upstream of the transition area, in which the driver is informed of lane changes, speed reductions, passing restrictions and the like.

ASTM

American Society for Testing and Materials.

At-grade Intersection

An intersection of two roadways where there is no vertical separation between the two roadways at their point of intersection.

ATSSA

American Traffic Safety Services Association.

Average Daily Traffic (ADT)

The total volume during a given time period in whole days greater than one day and less than one year, divided by the number of days in that time period.

B**Barricade**

A device which provides a visual indicator of a hazardous location or the desired path that a motorist should take, but is not intended to contain or redirect a vehicle. A barricade is intended to provide separation or inform of closure, or provide direction to pedestrians. A barricade is not the primary means of providing direction to motorists, but supplements other traffic control devices that provide delineation.

Barrier

A device which provides a physical limitation, through which a vehicle would not normally pass, and is intended to contain or redirect an errant vehicle of a particular size range, at a given speed and angle of impact.

Blocker Truck (BT)

A buffer vehicle (BV) that is not equipped with a truck-mounted attenuator (TMA).

Brightness

A term that refers to human perception of luminance. Whereas luminance is a photometrically measured quantity, brightness describes how intense a light source or lighted surface appears to the human eye.

Broken Line

A pavement marking that consists of a cycle of marking segments and gaps. Broken lines are permissive and inform drivers that they are permitted to cross a broken line (two-lane, two-way highways or multi-lane roadways) or that there is a change in the use of a particular lane (continuity lines).

Buffer Vehicle (BV)

A truck positioned in a stationary work zone or a mobile work operation to provide buffer protection for workers against errant vehicles that intrude into a work zone or mobile work operation. Buffer vehicle is a generic term which refers to either a Blocker Truck (BT) or a Crash Truck (CT). As required by the OHSA, a BV must have a minimum mass of 6800 kg, and must have a mounted TC-12 flashing arrow board and four-way flashers.

Bull Nose

The area or point of divergence between two diverging roadways, such as freeway mainline lanes and an exit ramp.

BV

Buffer vehicle.

C**Capacity**

The maximum number of vehicles which can pass over a given section of lane or a roadway in one direction, or both directions for a two- or three-lane highway, during a given time period (usually one hour) under prevailing roadway and traffic conditions.

Centreline

See Directional Dividing Line.

CGSB

Canadian General Standards Board.

Changeable Message Sign

A dynamic message sign which may display a limited number of fixed messages, any one of which may be displayed at any given time or with no message at all. It is an electrical, electro-optical, electromechanical, or mechanical sign which permits the sign message to be either locally or remotely changed. See also Dynamic Message Sign and Variable Message Sign.

Channelization

The separation or regulation of traffic movements into definite paths of travel by use of pavement markings, raised islands, channelizing devices, or other suitable means to facilitate the safe and orderly movement of both vehicular and pedestrian traffic.

Channelizing Devices

Cones, construction markers, flexible drums (barrels), pavement markings, and any temporary barriers used to alert drivers to and direct traffic past hazards created by construction or maintenance activities.

Chevron Alignment Sign

A delineation sign used to delineate sharp roadway alignment changes. See also OTM Books 6 and 11.

Closed Lane

A traffic lane on a roadway that has been closed off to traffic by channelizing devices, signs, temporary concrete barriers (TCBs), and/or TC-12 flashing arrow boards.

Collision

An incident that results in property damage, personal injury or death, and involves the loss of control and/or the striking of one or more vehicles with another vehicle, person, animal, or inanimate object.

Comprehension

The ability of drivers to understand the meaning of a sign message, including any symbols or abbreviations.

Cone of Vision

The small three-dimensional angle of vision, measured at about the axis of the eye's pupil, and from the surface of the eye, within which maximum visual acuity is achieved.

Conspicuity

The ability of a traffic control device to attract or command attention, given the visual setting in which it is placed.

Construction

All work zone activities, including pre-engineering activities, related to the building, infrastructure repair, or rehabilitation of highways or utilities that are along or crossing highways.

Construction and Maintenance Signs

A group of regulatory and warning signs used for the protection of public traffic and workers in the vicinity of a work area located on or near a roadway.

Construction Marker

ATC-52 channelizing device.

Construction Zone

One or more highway work zones located on or near a roadway. A construction zone must be designated and signed in order to have enforceable maximum speed limits.

Continuity Line

A lane line of reduced spacing and increased width, designed to alert road users to an impending change in lane function.

Continuous Wide Median

On a divided highway, a median that has a continuous width of 10 m or more. See also Divided Highway.

Contrast

Contrast refers to the differences in colour or brightness which allow a target, such as a sign message or symbol, to be seen against a sign background.

$$\text{Contrast} = (RL - RB)/RB$$

$$\text{Contrast Ratio} = RL/RB$$

where: RL is Reflectance of Legend; and RB is Reflectance of Background.

For light-emitting dynamic message signs, the same relationships apply, except that reflectance is replaced by emitted light intensity for both legend and background.

Controlled Access Rights of Way

Control of access is the condition where the right of access to or from a highway, by owners or occupants of abutting land or other persons, is fully or partially controlled by the road authority.

Crash

See Collision.

Crash Cushion

A traffic barrier used to safely shield fixed objects or other hazards from approximately head-on impacts by errant vehicles, which consists of energy-absorbing elements that are progressively deformed on impact.

Crash Truck (CT)

A Buffer Vehicle (BV) equipped with a truck-mounted attenuator (TMA) that meets the requirements of the National Cooperative Highway Research Program Report (NCHRP) 350.

Curve

A horizontal or vertical deviation in the roadway. A horizontal curve appears as a bend in the roadway, which requires drivers to turn their steering wheel. A vertical curve appears as either a “crest” or “sag” to provide for a change in gradient on the profile of the roadway.

Curve Sign

A warning sign used to inform drivers of an upcoming change in roadway alignment. In some cases, a reduction in speed is recommended.

Cyclist

A person who is riding a bicycle.

D**Deceleration Lane**

A speed change lane for the purpose of enabling a vehicle to make an exit from a roadway and slow to a safe speed on the exit after it has left the main stream of traffic.

Delineation

One or a combination of several types of devices (excluding guide signs) that regulate, warn, or provide tracking information and guidance to drivers.

Delineation Treatment

Refers to the higher-level decision process of designing delineation to be installed. Issues such as use of raised pavement markers and post markers are part of delineation treatment.

Delineators

Small, retroreflective devices erected in a series adjacent to the edge of the travelled portion of a roadway for the purpose of providing positive driver guidance.

Design Incoming Vehicle (DIV)

The selected vehicle or vehicles with the size and mass that correspond to a certain proportion of the vehicle population, or a defined level of protection, used in the determination of BV mass and roll-ahead distances for the design of construction and maintenance work zones.

Design Speed

A speed selected for the purposes of the design and correlation of those features of a highway, such as curvature, superelevation, and sight distance, upon which the safe operation of vehicles is dependent.

Detector

A device that indicates the presence or passage of vehicles, including sensor devices, lead-in cables and detector sensor (amplifier) units.

Detour

A diversion from the usual travelled roadway; either a crossover from one multi-lane roadway to another (within the highway right-of-way), or a route detour.

Detour Marker

A sign used to identify a route detour for detour route continuity to assist driver navigation.

Device

See Traffic Control Device.

Directional Dividing Line

A yellow pavement marking that indicates the division of the roadway between traffic travelling in opposite directions.

Directional Guide Sign

A broad class of signs that provide route-finding or operational guidance to road users, including directions to specific destinations.

Divided Highway

A multi-lane highway that consists of roadways for opposing traffic which are separated by an unpaved area or other physical barriers, including a curbed island. See also Continuous Wide Median.

Downstream

The direction that traffic is going to.

Driver

A person who operates a vehicle on a highway.

Driver Response

The action taken by a driver as a result of reading a traffic sign or encountering another traffic control device.

Duration

1. The length of time for which a given state, condition or phase exists.
2. In temporary conditions, the length of time for specific construction, maintenance or utility work activities to take place, and for which specific requirements and typical layouts apply. See Mobile Operations, Very Short Duration, Short Duration, and Long Duration.

Dynamic Message Sign

A sign that has the capability of displaying different messages to suit changing conditions on a roadway. A dynamic message sign may be a changeable message sign (limited function) or a variable message sign (full function).

E**Edge Line**

A painted line that marks the edge of a roadway.

Eighty-fifth (85th) Percentile Speed

The speed at, or below which, 85% of motorists are travelling.

Emergency

With regard to road works, an emergency is an unforeseen, unplanned combination of circumstances or the resulting situation that calls for immediate action in order to prevent or reduce damage or hazard to road users, workers, or infrastructure. In an emergency, short duration traffic control provisions should be implemented to the greatest extent practicable, including adequate reflectorization if at night, in order to avoid the creation of additional hazard.

Engineering Grade Material

A retroreflective sign sheeting material that meets ASTM Specification D-4956-95 for Type I material or CGSB Specification 62-GP-S11M for Reflectivity Level II material.

Expectancy

Used in traffic engineering to describe a driver's anticipation of upcoming road design and traffic control conditions. Driver expectancy is usually affected by previous experience and the consistency and continuity of traffic control devices encountered. Violation of driver expectancy should be avoided whenever possible.

Expressway

A divided, multi-lane arterial highway for through traffic with full or partial control of access and generally with grade separations at major intersections. Some intersections may be at-grade.

F**f**

Coefficient of friction; sometimes CoF is used.

Field Edition

The portable abbreviated version of Ontario Traffic Manual (OTM) Book 7

Fluorescence

The emission of light produced by certain substances when excited by an ultraviolet (UV) energy source. This emission ceases when the UV source is removed.

Fluorescent Orange and Yellow-Green

Fluorescent sign sheeting colours designed for high conspicuity in daytime. Fluorescent sign sheeting may be non-reflective (daytime use only) or reflective (daytime and night-time use).

Freeway

For the purpose of the guidelines of OTM Book 7 a freeway is defined as a multi-lane divided highway with a continuous dividing median (demarcated by more than pavement markings), full control of access and interchanges in place of at-grade intersections, and a normal posted regulatory speed (NPRS) of 90 km/h or greater. This term includes all 400 series divided highways and toll highways built to a freeway configuration, and all freeway speed transition zones where the speed limit has been reduced approaching the end of the freeway and other areas where speed reductions are in place due to geometrics such as curves or freeway to freeway ramps.

G**Geometry**

In terms of roadway design, geometry refers to the physical characteristics and dimensions of roadway parts.

Gore

The area between and immediately adjacent to two merging or diverging roadways; the area may be painted or unpainted.

Grade Crossing

A railroad that crosses a highway at the same elevation (no vertical separation).

Grade Separation

The vertical separation of two or more intersecting roadways or a roadway and another transportation mode, e.g., railroad, thus permitting traffic on all roads to cross traffic on all other roads without interference.

Gross Vehicle Weight

The total weight in kilograms transmitted to the highway by a vehicle or combination of vehicle and load. This is not the same as the registered gross vehicle weight, which is a licensed measure.

Guide Rail

A fence or barrier to guide and help restrain vehicles from leaving a roadway.

Guide Sign

A traffic sign used to direct traffic along a route towards a destination.

Guideline

A recommended practice, method, or value for a specific design feature or operating practice.

H**Hazard Marker**

See Object Marker.

Headway

The spatial distance or time interval between the front ends of vehicles that are moving along the same lane or track in the same direction.

High Intensity Material

A retroreflective sign sheeting material that meets ASTM Specification D-4956-95 for Type III or IV or CGSB Specification 62-GP-11M for Reflectivity Level I material.

Highway

A general term that denotes a public way for the purposes of vehicular and pedestrian travel, including the area within a right of way. This includes King's Highways, regional and county roads, rural roads, municipal roads, and streets.

Highway Delineator

One of a series of short posts with reflective heads or chevrons, used to indicate horizontal alignment.

Highway Traffic Act (HTA)

The Ontario Highway Traffic Act.

Human Factors

The consideration of human physical, perceptual, and mental limitations in engineering design, so as to optimize the relationship between people and things. The objective is to reduce errors and increase user comfort.

I**Information Load**

The amount of information presented to a driver by a sign or other traffic control device(s), which is a factor in determining the amount of time that drivers require to read, comprehend, and act on a message.

Installation

The process or act of placing, erecting, and/or connecting a traffic control device or system into its functional position and state of operational readiness.

Interchange

A system of interconnecting roadways in conjunction with one or more grade separations, providing for the interchange of traffic between two or more roadways on different levels.

Interdictory Symbol

An annular (circular) red band with a diagonal red stroke at 45 degrees, or as close to 45 degrees as practicable, signifying that whatever is depicted within the symbol is prohibited.

Intermittent

Not continuous. As used for traffic control devices, usually means regularly spaced either in time or space. Otherwise, may mean regularly or irregularly timed or spaced.

Intersection

The area embraced by the prolongation of lateral curb lines, or if none, the rights of way of two or more highways that join one another at an angle, whether or not one highway crosses the other.

Intersection Approach

The part of an intersection leg used by traffic that is approaching an intersection.

Intersection Channelization

Raised or painted islands at an intersection that prevent specific movement(s) from being made or provide better definition of large uncontrolled areas of pavement.

Intersection Leg

The part of any one of the roadways that radiate from the intersection which is close to the intersection but outside the area of the intersection proper.

J**Jurisdiction**

A legal or other authority with responsibility and control for specific actions within a defined area.

K**Kilometre (km)**

A measure of distance equal to 1000 m (0.622 miles).

King's Highway

A highway, including secondary and tertiary roads designated under the Public Transportation and Highway Improvement Act.

km

Abbreviation for kilometre.

L**Lane**

A defined width of road intended to accommodate a single line of moving vehicles.

Lane Line

A pavement marking, other than a directional dividing line, which separates two traffic lanes assigned to traffic which is moving in the same direction.

Large Arrow Sign

A warning sign intended to inform drivers of a sharp change in roadway alignment or the need for a lane change (see Sign Wa-108 in OTM Book 6, and Signs TC-7 and TC-12 in OTM Book 7).

Lateral Intrusion Deterrence Gap (LIDG)

The gap between a BV and the work area to discourage lateral vehicle intrusions into a closed lane upstream of a stationary work area, or the gap between a BV and work vehicle (and between BVs) to discourage lateral vehicle intrusions into a lane where mobile work operations are taking place.

LBA

See Longitudinal Buffer Area.

Left-turn Lane

A lane reserved for left-turning vehicles and designated so by pavement markings and/or lane-use signs.

Legal Authority

The authority provided, by legislation and regulation, to a jurisdiction or enforcement body for the actions that it takes.

Legibility Distance

The distance at which a sign can be read by a given driver under prevailing conditions.

Legibility Distance, Required

The distance at which a sign must be legible, based on the travel speed and the sum of reading, perception-reaction, and manoeuvre times.

Level of Service (LOS)

A term which, broadly interpreted, denotes any one of an infinite number of differing combinations of operating conditions that may occur on a given lane or roadway when it is accommodating various traffic volumes. Level of service (LOS) is a qualitative measure of the effect of a number of factors, which include speed and travel time, traffic interruptions, freedom to manoeuvre, safety, driving comfort and convenience, and operating costs. In practice, selected specific levels are defined in terms of particular limiting values of certain factors, as in Levels A (free-flow) to F (stop and go) in the Highway Capacity Manual.

LIDG

See Lateral Intrusion Deterrence Gap.

Live Lane

A roadway lane open to traffic. It includes a traffic lane where vehicles, although they may be present, are being diverted away from a stationary or mobile work activity by work vehicles or BVs equipped with traffic control devices, such as a TC-12.

Local Road

A street or road primarily for access to residence, business, or other abutting property.

Long Duration Work

Stationary maintenance, construction, or utility activities which require a separate work space for longer than 24 hours. See also Short Duration (SD) and Very Short Duration (VSD) work.

Longitudinal Buffer Area (LBA)

On non-freeways, the LBA is the fourth component of a stationary work zone, downstream from the transition area and upstream of the work area, which provides protection for traffic and workers, by providing errant vehicles the opportunity to brake to a halt between the end of the transition area and the work space. On freeways, the LBA is the space between the end of a lane-closure taper and the crash truck, which provides errant vehicles the opportunity to brake to a halt between the end of the taper and the crash truck.

Low Volume/High Volume Road

For temporary conditions, low volume roads are defined as those with a combined traffic volume in both directions of less than 3000 vehicles per day. Conversely, high volume roads are those with a combined traffic volume of 3000 vehicles per day or more.

Luminance

The luminous flux in a light ray, which emanates from a surface or falling onto a surface, in a given direction, per unit of projected area of the surface as viewed from that direction, per unit of solid angle (reflective light).

M**m**

Abbreviation for metre.

Maintenance

The upkeep of highways, traffic control devices, other transportation facilities, property, and/or equipment.

Major Road

The principal route of two roads at an intersection. Also called main road.

Manoeuvre Time

The time to complete any required manoeuvre before reaching a sign, other traffic control device, or decision point.

Marker

See Construction Marker, Detour Marker, Object Marker.

Marking (Pavement)

See Pavement Marking

Maximum Speed

The maximum speed that drivers are permitted to travel. The maximum speed is imposed by the Highway Traffic Act (HTA), or municipal by-laws. See also Normal Posted Regulatory Speed.

May

Indicates a permissive condition. No requirement for design of application is intended. However, mandatory requirements apply to some specific options if and when they are selected.

Measure

A physical device, traffic control device, regulation, or other action which affects the movement of motor vehicles, bicycles, and/or pedestrians.

Median

The portion of a divided highway that separates the travelled ways for traffic in opposite directions.

Median Barrier

A raised island, wall, or structure located on the centreline of a roadway through an intersection or along a road, which prevents left turns or straight through movements from being made to and from a side street or private/commercial driveway.

Median Island

A zone or physical island constructed in the centre of a roadway to separate opposing directions of traffic.

Median Strip

An expanse of hard surface material that separates opposing lanes on a highway. The hard surface is flush or nearly flush with the adjacent lanes.

Merging

The convergence of separate streams of traffic into a single stream.

Milling

The grinding off and removal of old asphalt for the purposes of recycling and resurfacing. Milling may produce undesirable longitudinal grooves which affect the behaviour of some vehicles.

Minimum Typical Guideline

Where so described, the guideline depicted in the typical layouts for temporary conditions represents the minimum requirements that must be achieved.

Ministry

Unless otherwise specified, the Ministry of Transportation Ontario (MTO). Where so specified, the Ministry means the Ontario Ministry of Labour (MOL).

Minor Road

The lesser of two roads at an intersection.

Mobile Operations

Mobile Operations involve work that is done while continuously moving, usually at low speeds (typically 5 to 30 km/h). Mobile Operations may have periodic brief stops related to the mobile activity which do not exceed a few minutes in duration. During a brief stop, no planned work takes place outside of the work vehicle.

MOL

The Ontario Ministry of Labour

Motor Vehicle

Includes an automobile, motorcycle, motor-assisted bicycle (moped), and any other vehicle propelled or driven other than with muscular power, but does not include a streetcar, or other vehicles designed to operate on rails, or a motorized snow vehicle, traction engine, farm tractor, and implements of husbandry or road-building machine.

Motorist

See Driver.

MTO

The Ministry of Transportation Ontario.

Multi-lane Highway

A roadway with two or more travelled lanes in each direction.

Must

Indicates a mandatory condition. Where certain requirements in the design or application of the device are described with the “must” stipulation, it is mandatory that these requirements be met when an installation is made.

MUTCD

The Manual of Uniform Traffic Control Devices for Ontario, 1995, superseded over time by the Ontario Traffic Manual.

MUTCDC

The Manual of Uniform Traffic Control Devices for Canada, latest edition.

MUTCD-US

The U.S. Manual of Uniform Traffic Control Devices, latest edition.

N

Narrow Lanes

Lanes in a work zone which are narrower than usual, as required by construction, maintenance, utility, or other operations.

NCHRP

National Cooperative Highway Research Program (U.S.)

Night-time

The hours of darkness, taken as the time period from one-half hour before sunset to one-half hour after sunrise.

Night-time Short Duration Provisions

Provisions required for night-time short duration work, even though one or more may be shown as optional for daytime short duration operations illustrated in the typical layouts. See Section 2.6.4. For night-time work of any duration, traffic garments that meet OSHA requirements for night-time work must be used.

Normal Posted Regulatory Speed (NPRS)

The regulatory maximum speed posted on a highway under normal conditions, that is, when no construction zone or work activity is present. Guideline provisions provided in OTM Book 7 are based on normal regulatory posted speed, not temporarily reduced construction zone regulatory or advisory speeds.

O

Object Marker

A traffic sign temporarily or permanently mounted on an obstruction, within or adjacent to a roadway, to make the obstruction as highly visible as possible.

Occupational Health and Safety Act

The Ontario Occupational Health and Safety Act and Regulations for Construction Projects by the Ontario Ministry of Labour.

Off-peak Period

The period of time, usually outside the morning and afternoon peak periods. If there is a midday peak with traffic volumes that equal or approach those in the a.m. or p.m. periods, then this midday peak should be excluded from the off-peak period.

Official Sign

Any sign approved by the MTO.

OHSA

See Occupational Health and Safety Act.

Operating Speed

The speed at which the majority of vehicles are travelling, typically the 85th percentile, regardless of the speed limit.

Oversize Sign

A traffic sign with greater proportional dimensions than the minimum dimensions specified in this manual. Such signs are generally required on higher speed highways, or other highways in special cases.

P**Partial Lane Shift**

The temporary, partial shifting of travel lanes by demarcating them through the use of cones or barrels, so that the lanes are squeezed while still maintaining usable lane widths of at least 3 m in each lane. See also Narrow Lanes and Roadside Diversions.

Pavement

The part of a roadway that has a constructed hard surface for the facilitation of vehicular movement.

Pavement Marking

A coloured marking applied to the pavement to provide drivers with roadway alignment information.

Peak Hour

The one hour each day when traffic volumes are at their highest on a given road.

Peak Period(s)

One or more periods each day, usually consisting of two or three hours, when traffic volumes are at their highest on a given road, usually corresponding to a morning “to work” period and an afternoon “from work” period.

Pedestrian

Any person who is on foot, not in or on a vehicle, motorized or otherwise propelled, or riding on an animal.

Perception-reaction Time

The time required to make a decision, after reading or encountering a traffic control device, and initiate a manoeuvre if required.

Permissive Symbol

An annular (circular) green band used on a sign to signify that whatever is depicted within the symbol is permitted.

Phase (Traffic Signal)

A part of a cycle where one or more traffic movements receive a green indication at the same time. Phase time is the time required from the start to the finish of the phase, including amber and all-red interval times.

Portable Variable Message Sign (PVMS)

A variable message sign that may be moved from place to place to provide drivers with information on conditions, usually work zone conditions, at the time and place where needed.

Positive Guidance

Provision of information to road users that they will need to avoid hazards, when and where they need it, in a form that they can best use it. See OTM Book 1c (Positive Guidance Toolkit).

Posted Advisory Speed

The maximum advisory speed as indicated by appropriate warning or temporary condition signs.

Posted Speed Zone

A section of highway upon which the maximum speed is indicated by appropriate regulatory signs.

Pre-engineering and Engineering Activities

Activities carried out in preparation for, during, or after completion of a construction project (e.g., surveying, geotechnical sampling or testing, pre-construction inspection). For the purposes of traffic control, pre-engineering activities are considered as a part of the construction work activities in OTM Book 7.

Provincial Highway

Any public highway under the jurisdiction of the MTO. See King's Highway.

Public Roadway

Any roadway under the jurisdiction of and maintained by a public authority and open to public travel.

Public Way

A sidewalk, street, highway, square, or other open space to which the public has access, as a right or by invitation, either expressed or implied.

R**Railroad Crossing**

A location where one or more railroad tracks cross a public highway, road, street, or a private roadway, and includes sidewalks and pathways at or associated with the crossing.

Raised Pavement Marker

A ceramic, metal, glass, or plastic marking device placed on or in the roadway to substitute for or act as a supplement to standard pavement markings. Raised pavement markers comprise a variety of configurations, including retroreflective and non-retroreflective markers, and markers that employ prismatic and spherical retroreflectors.

Ramp

An interconnecting roadway of a traffic interchange, or any connection between highways at different levels or between parallel highways, on which vehicles may enter or leave a designated roadway.

Reading Time

The time required to read a sign with a given message.

Reflectivity

A measure of the degree to which a surface reflects incident light. A related term, reflectance, is the amount of light reflected back from a sign, relative to the amount of light that shines on a sign. See Retroreflectivity, Coefficient of (R).

Reflectorization

A method of incorporating light-reflective material on the approach face of a traffic sign so that the face will reflect light during the hours of darkness while retaining the same colours as by day.

Regulation

A prescribed rule, supported by legislation, such as any regulation made under the HTA or OHSA or municipal by-law. Regulations provide the legal basis for enforcement.

Regulatory Sign

A traffic sign that advises drivers of the action that they should or must do (or not do) under a given set of circumstances. Disregard of a regulatory sign usually constitutes as an offence.

Retroreflective Material

A type of material applied in either strips or sheets which reflects illumination back to its source.

Retroreflectivity, Coefficient of (R)

R indicates the proportion of light reflected back to the driver from a retroreflective sign surface, in candelas per lux per square metre. See Section 9.1 in OTM Book 1b (Sign Design Principles).

Right of way

1. Allocation of right of movement to a road user, with preference over other road users.
2. The width of the road allowance from the property line on one side to the property line on the opposite side of a roadway.

Road

See Highway.

Road Authority

The body (municipal, provincial, or private) that has legal jurisdiction over a roadway.

Road Closure

The closing of a highway to road users. Road closures are covered by Regulation 599 of the HTA.

Road Edge Work

Construction, maintenance, or utility work that encroaches onto the edge of a road, with much of the work being done on the shoulder. Road edge work is not fully on the shoulder, nor does it result in a remaining travel lane width that is less than 3.0 m (3.5 m on freeways), which would necessitate a lane closure or a partial lane shift. See also Roadside Work.

Roadside Diversion

A deviation of a normal roadway, essentially within a highway right of way, where traffic is required to make a short diversion to bypass a work area. The diversion must be signed by using a TC-9, TC-16, and/or other appropriate signs.

Roadside Work

Construction, maintenance, or utility work that is done on a shoulder or the edge of a road.

Roadway

The part of the highway that is improved, designed, or ordinarily used for vehicular traffic, but does not include the shoulder, and where a highway includes two or more separate roadways, the term “roadway” refers to any one roadway separately and not to all of the roadways collectively.

Roadway Alignment Sign

A warning sign or temporary condition sign used to inform drivers of an upcoming change in roadway alignment, including turns and curves.

Roadway Edge Line

See Edge Line.

Route Detour

A detour where a driver is required to completely depart from the normal route and directed to use an alternate route. The alternative route must be signed by using a combination of the appropriate TC-10 directional signs. Prior to the closing of the roadway and opening of a detour, a TC-65 “Road Closing Notice” sign must be erected at strategically selected locations of the road at least one week in advance of the actual closing.

Rural Area

An area outside of the limits of any incorporated or unincorporated city, town, village, or any other designated residential or commercial area.

S**Safe Stopping Distance**

The distance required to completely and safely bring a vehicle to rest with normal braking and road conditions.

Shall

Means the same as “must”.

Short Duration (SD) Work

Short Duration work refers to activities that require work areas that are continuously occupied by workers and/or equipment, for more than 30 minutes but less than one 24-hour period in duration.

Should

Indicates an advisory condition. Where the word “should” is used, the action is advised; recommended but not mandatory. This term is meant to suggest good practice in most situations, but also to recognize that in some situations, for good reasons, the recommended action cannot or need not be followed.

Shoulder

The portion of the highway between the outer edge of the roadway and the curb or point of intersection of the slope lines at the outer edge of a roadway and the fill, ditch, or median slope, for the accommodation of stopped vehicles, for emergency use and lateral support.

Sight Distance

The distance visible to the driver of a vehicle, measured along the normal travel path of a roadway, to the roadway surface or a specified height above a roadway, when the view is unobstructed by traffic.

Sign

A traffic control device mounted on a fixed or portable support which conveys a specific message by means of symbols or words, and is officially installed for the purpose of regulating, warning, or guiding traffic.

Sign Assembly

Any traffic sign mounted and installed alone or in conjunction with any combination of associated tab signs.

Sign Blank Number

The number conferred to a given size of a standard size blank (substrate), for the purposes of identification, inventory, and fabrication.

Sign Pattern

The full-size hard copy drawings or electronic images of individual signs, which show sufficient detail and dimensional accuracy for sign fabrication.

Sign Sheeting

The retroreflective material used on the surface of a sign to provide good daytime and night-time visibility.

Sign Support

The physical means of holding a sign in its intended position.

Sign Symbol

A pictogram, depiction, arrow, silhouette or figures, and/or interdictory or permissive symbols, used to simplify or represent a word message on a sign.

Sign Truck

A vehicle that has:

1. four-way flashers and a mounted flashing arrow board sign, or
2. a portable trailer with a mounted flashing arrow board sign.

Signal Indication (Traffic Signal)

The illumination of one or more lenses in a signal head which conveys a message to traffic that is approaching the signal from one direction.

Signalized Control

The use of a traffic signal control device to control traffic on a road section or intersection.

Speed Change Lane

A tapered auxiliary traffic lane used by traffic that is entering or leaving a freeway or expressway for the purpose of acceleration or deceleration, respectively.

Speed Limit

The maximum vehicular speed allowed within any given posted or unposted speed zone.

Speed Zone

A specific section of roadway upon which a maximum speed limit has been imposed. Such zones may be posted or unposted. A construction speed zone must be posted.

Standard

A rule, principle, pattern, or measure, which practice or theory has shown to be appropriate for a given set of conditions, and applicable, as the case may be, to planning, design, traffic control devices, operations, or maintenance.

Statutory Speed Limit

A maximum speed limit automatically in effect on all roads, unless otherwise signed. The statutory speed limit applies even where no maximum speed limits are signed.

Stopping Sight Distance

The distance required by a driver of a vehicle, travelling at a given speed, to bring the vehicle to a stop after an object on the roadway becomes visible. It includes the distance travelled during the perception-reaction time and the vehicle braking distance.

Street

An urban highway.

Striper

A self-contained marking system mounted on a truck chassis and used to apply pavement markings on the road.

Substrate

The surface on which sign sheeting is applied.

T**Tab Sign**

A sign which is smaller than its associated primary sign, and mounted below it. There are two types of tab signs:

1. supplementary tab signs – contain additional, related information, and
2. educational tab signs – convey the meaning of symbols during their introductory period.

Tangent Section

1. A straight section of roadway between curves.
2. In temporary conditions, the distance between the end of one taper and the beginning of the next taper, where more than one lane is being closed.

Taper

The gradual narrowing of a lane which is intended to safely guide drivers into an adjacent lane. The taper length is the length of the section of roadway required to achieve full lane closure (e.g., construction zone) or full lane transition.

TC

Abbreviation for temporary conditions.

Temporary Concrete Barrier (TCB)

The most common barrier system. TCBs used in Ontario must meet the requirements of the Ontario Provincial Standards Specifications and placed in accordance with the Ontario Roadside Safety Manual. They are commonly used in section lengths of 2.5 to 4.0 m, connected together to form a continuous barrier.

Temporary Conditions (TC)

Roadway and traffic control conditions related to non-permanent construction, maintenance, and utility work on any highway open to the public.

Temporary Pavement Marking

A pavement marking intended to be used for temporary conditions.

Temporary Sign

A regulatory, warning, or guide sign, intended to be used for temporary conditions.

Temporary Traffic Signal

A temporary traffic signal installed to control traffic at a crossing, such as a temporary roadway, truck access route, pedestrian crossing, etc. A temporary traffic signal must comply with Section 144(31) of the HTA. The design specifications for temporary signals, which require prior approval by the appropriate road authority, are specifications which apply to permanent traffic control signals at signalized intersections (for details, see Section 3.2.2 in OTM Book 7, and OTM Book 12 (Traffic Signals)).

Termination Area

The sixth and last component of a work zone, downstream of the work area, used for traffic to make the transition back to the normal path of a road. The termination area extends from the downstream end of the work area to the point where traffic is able to resume normal driving.

TMA

See Truck-mounted Attenuator.

Traffic Control Device

Any sign, signal, marking, or device placed upon, over, or adjacent to a roadway by a public authority or official, or private road owner, with jurisdiction, for the purpose of regulating, warning, guiding, or informing road users.

Traffic Control Installer

A person duly trained and authorized to install and remove traffic control devices in a work zone.

Traffic Control Person (TCP)

A person duly trained and authorized to direct traffic at a work zone through the use of a traffic control sign (STOP/SLOW paddle).

Traffic Control Plan

A detailed plan for the control of traffic during construction, maintenance, or utility operations on a highway, taking into account the organized, systematic, safe conduct of a project, including, as applicable, detours, staging sequences, work vehicle access to and departure from work sites, temporary barriers, removal of old pavement markings, and selection and planned implementation of appropriate typical layouts for traffic control.

Traffic Control Signal (Traffic Signal)

Any power-operated traffic control device with at least three signal lenses, whether electrically or mechanically operated, by which traffic is alternately directed to stop and permitted to proceed.

1. When used in general discussions, a traffic signal is a complete installation including signal heads, wiring, controller, poles, and other instruments.
2. When specifically used, the term refers to the signal head which conveys a message to the observer.
3. The part of a traffic control signal system that consists of one set of no less than three coloured lenses; red, amber and green, mounted on a frame and commonly referred to as a signal head.

Traffic Count

A record of the number of vehicles or people aboard vehicles, or both, and pedestrians that pass a given checkpoint during a given time period.

Traffic Protection Plan

A plan required by the OHSA and its regulations for the protection of workers in a work zone. The plan must contain a written description of the traffic hazards to which workers may be exposed and measures used to protect them.

Traffic Sign

A device (other than markings, delineators, and traffic control signals) which may be installed beside or above a roadway for the purpose of regulating, warning, or guiding traffic.

Traffic Signal Control System

An area or corridor signal system under signalized control.

Transition Area

The third component of a work zone, downstream from the approach area, and upstream of the longitudinal buffer area, where traffic is channelled from a normal path to a new path required to move traffic past a work space. The transition area contains the tapers and parallel tangent sections (if more than one lane closed) that are used to close the lanes effectively.

Truck

A commercial vehicle that exceeds a specified weight or length as defined by the HTA, municipal by-law, or toll agency.

Truck-mounted Attenuator (TMA)

An energy-absorbing device mounted on the rear of a truck, which deforms on impact in a controlled manner, thereby reducing:

1. the rate of deceleration (and associated injury) for the occupants of a vehicle that has struck the TMA from the rear; and
2. the rate of acceleration (and associated injury) for the driver of the truck.

TMA's must satisfy the requirements of NCHRP 350 Level TL-2 (70 km/h) or TL-3 (100 km/h), and should be selected for the appropriate posted speed. All TMA's used on freeways must satisfy the TMA TL-3 requirement (100 km/h).

Turn Lane

A lane designated to facilitate vehicular turn movements from a through roadway.

Turn Prohibition

A regulation that prohibits a straight-through movement or a left/right turn at an intersection. Turn prohibitions are sometimes used in association with barriers that physically prevent a turn from being made.

Two-lane Highway

An undivided two-way facility that has one lane for traffic moving in each direction.

Two-way Left-turn Lane

The centre lane on some of the three, five, or seven lane sections of undivided highways which is designed to facilitate left turns from each direction.

U**Undivided Highway**

A multi-lane highway with no continuous median, or a paved flush dividing strip (including a rumble strip), or with a two-way left-turn lane.

Upstream

The direction that traffic is coming from.

V**Vehicle**

Includes a motor vehicle, trailer, traction engine, farm tractor, road-building machine, bicycle, and any vehicle drawn, propelled, or driven by any kind of power, including muscular power, but does not include a motorized snow vehicle or motorcycle sidecar.

Very Short Duration (VSD) Work

Any work activity which occupies a fixed location for up to 30 minutes in duration, including set-up and takedown of the traffic control provisions (e.g., some utility work, minor road maintenance, storm-water catchbasin cleanout, etc.). The work site may be moved along the road and make frequent, short stops.

Volume

The number of vehicles or pedestrians that pass over a given section of a lane or roadway, or make a particular movement during a specific time period (such as one hour or 24 hours).

W**Warning Sign**

A sign which indicates conditions on or adjacent to a highway or street that are actually or potentially hazardous to traffic operations.

Work Area

The fifth component of a work zone, downstream from the LBA and upstream of the termination area, where the work takes place. It is set aside for workers, equipment, and material storage. A work area may or may not contain a work vehicle. The work area may be in a fixed location or move as work progresses. It may be defined by delineation devices. In a confined location, the work space may be shielded by barriers as an additional feature.

Work Site Identification

Visible identification of the work area by passive and/or active traffic control devices to show road users where work is taking place.

Work Zone

A section of a highway or roadway where highway-related construction, maintenance, or utility work is taking place. A work zone is usually made up of six component areas (See Figure 1), including the area where the work takes place. A work zone can be in the travelled portion of the road or on the boulevard or shoulders and may be stationary or mobile. See Mobile Operations, Very Short Duration, Short Duration, and Long Duration Work.

Y**Yield**

To cede the right of way.

A3

Appendix 3: References**Referenced Documents:**

American Road & Transportation Builders Association/Texas Transportation Institute. (1999) Equipment Details. Screen-Safe™ Highway Glare Screen & Work Zone Safety Shield. [Internet], http://www.workzonesafety.org/safety_products/record/10101 (equipment link: TranspoR Industries, Inc. <http://www.transpo.com/>).

American Society of Testing and Materials (ASTM). (1995) Specification D 4956-11a. Standard Specification for Retroreflective Sheeting for Traffic Control. West Conshohocken, PA.

American Traffic Safety Services Association (The). (1993) Quality Standards for Work Zone Traffic Control Devices. [Internet]. Fredericksburg, VA. American Traffic Safety Services Association.

Canadian General Standards Board. (1978) Specification 62-GP-11M (Amendment No. 2, 1987).

Colavincenzo, O. and Harmelink, M. (2001) Protection of Workers in a Work Zone from Errant Vehicles, ON. Dillon Consulting Ltd.

Health and Safety Ontario. (1991) Handbook for Construction Traffic Control Persons. [Internet]. Mississauga, ON. Infrastructure Health & Safety Association.

Ministry of Transportation - Ontario and Municipal Engineering Association. (2010) Ontario Provincial Specification Standards (OPSS). ON.

Ministry of Transportation – Ontario (1993) Roadside Safety Manual. St. Catharines, ON. Ministry of Transportation Ontario.

Ministry of Transportation – Ontario (2000). Temporary Conditions Traffic Management; Advance Notification, Advance Warning and Alternative Route Signing for Provincial Highways in MTO Central Region. For use on Provincial Highways and other roadways in MTO's Central Region. Downsview, ON. Central Region Traffic Office.

Ministry of Transportation – Ontario (MTO). (2007) Ontario Traffic Manual. Book 10. Dynamic Message Signs. [Internet]. St. Catharines, ON. Ministry of Transportation Ontario.

Ministry of Transportation – Ontario (MTO). (2005) Ontario Traffic Manual. Book 2. Sign Design, Fabrication and Patterns. [Internet]. St. Catharines, ON. Ministry of Transportation Ontario.

Ministry of Transportation – Ontario. (1999) Proposed PCMS Message Format for Incident Management / Construction Closures on Standard Provincial Highways;

Ministry of Transportation – Ontario. (2000 and 2001) Ontario Traffic Manual; Books 1,1a,1b,1c,2,3,4,5,6,11,and 12. St. Catharines, ON. Ministry of Transportation Ontario.

Ministry of Transportation Ontario. (1985) Manual of Uniform Traffic Control Devices (no longer published).

Ontario Ministry of Transportation. (1985) Geometric Design Standards for Ontario Highways (GDSOH) manual. Queen's Printer for Ontario.

Province of Ontario (1986). Public Transportation and Highway Improvement Act; Revised Statutes of Ontario, 1990, Revised Regulations of Ontario, 1986.

Province of Ontario (1990). Municipal Act; Revised Statutes of Ontario.

Province of Ontario. (1990) Highway Traffic Act (HTA); Office Consolidation; Revised Statutes of Ontario, 1990, and the Regulations thereunder (as amended), 1996. ON.

Province of Ontario. (1990) Ontario Health & Safety Act and Regulations for Construction Projects; Revised Statutes of Ontario, 1990, Revised Regulations of Ontario 213/91 as amended by 631/94 and 145/00. Ontario Ministry of Labour.

(1994) Regulations for Railway and Roadway Level Crossings. Queen's Printer for Canada,

Ross, H.E. Jr., Sicking, D.L., Zimmer, R.A., and Michie, J.D. (1993) Recommended Procedures for the Safety Performance Evaluation of Highway Features; NCHRP Report 350. Washington D.C. National Academy Press.

Transportation Association of Canada. (1997) Manual of Uniform Traffic Control Devices for Canada; Fourth Edition. Ottawa. Transportation Association of Canada.

U.S. Department of Transportation. (1993) Manual of Uniform Traffic Control Devices; Part VI, Standards and Guides for Traffic Controls for Street and Highway Construction. Maintenance, Utility, and Incident Management Operations, 1988 Edition of MUTCD, Revision 3. Washington, D.C. Federal Highway Administration.

U.S. Department of Transportation. (1997) Manual of Uniform Traffic Control Devices. Washington, D.C. Federal Highway Administration.

U.S. Department of Transportation. (1999) Traffic Control Devices on Federal-Aid and Other Streets and Highways; Color specifications for Retroreflective Sign and Pavement Marking Materials. Washington, D.C. Federal Highway Administration, Federal Register. 64 (244).

Additional References and Literature Reviewed:

Alberta Transportation (2001) Traffic Accommodation in Work Zones. [Internet]. Edmonton, AB.

American Traffic Safety Service Association. (2011) Pedestrian Safety and Accessibility in Work Zones. [Internet]. USA.

American Traffic Safety Services Association (The) (ATSS). (2010) Guidelines on the Use of Positive Protection in Temporary Traffic Control Zones. [Internet]. Fredericksburg, VA. Federal Highway of Administration.

American Traffic Safety Services Association (The) (ATSSA). (2009) Work Zone Positive Protection Toolbox. [Internet] Fredericksburg, VA. Federal Highway Administration.

Antonucci, N.D., Hardy, K.K., Bryden, J.E., Neuman, T.R., Pferer, R. & Slack K. (2005) Guidance for Implementation of the AASHTO Strategic Highway Safety Plan Volume 17: A Guide for Reducing Work Zone Collisions. Washington D.C.

Bligh, R.P, Menges, W.L. & Haug, R.R. (2006) Crashworthy Work-Zone Traffic Control Devices. Washington, D.C.

British Columbia Ministry of Transportation and Highways. (1999) British Columbia: Traffic Control Manual. [Internet]. Victoria, BC.

CAA South Central Ontario. (2009) Emergency Road Service Manual.

Campbell, J.L., Richard, C.M., Brown, J.L., Lichty, M.G., Graham, J. & O'Laughlin, M. (2010) Human Factors Guidelines for Road Systems Collection C: Chapters 16, 17, 18, 19, 20, 22 (Tutorials 4, 5, 6), 23 (Updated), 24, 25, 26 (Updated). Washington, D.C.

Centre for Health and Safety Innovation (2001) Guidelines for a Traffic Protection Plan. Mississauga, ON.

CDED Special Provisions Archive Document. <http://www.raqsa.mto.gov.on.ca/techpubs/cdeda.nsf/CDEDwv?OpenView>.

Construction Safety Association of Ontario. (2010) Handbook for Construction Traffic Persons. [Internet]. Mississauga, ON. Infrastructure Health & Safety Association.

District Department of Transportation. (2004) DC: Temporary Traffic Control Manual. [Internet]. Washington, DC

Dunn, W.M. & Latoski, S.P. (2003) A Synthesis of Highway Practice. Washington, D.C.

- Ellis,R.D., Amos,S. & Kumar,A. (2003) Illumination Guidelines for Nighttime Highway Work. Washington, D.C.
- Elvey, R. and Morall, J. (2003) Emergency Traffic Management. In: Transportation Association of Canada, The Transportation Factor 2003 Annual Conference of the Transportation Association of Canada. St. John's, Newfoundland and Labrador. September 21 to 24, 2003. Transportation Association of Canada: Ottawa, ON.
- Florida Department of Law Enforcement (2006) Traffic Crash Investigations. Tallahassee, FL.
- Infrastructure Health & Safety Association (2011) Guidelines for Training Traffic Control Persons. Mississauga, ON.
- Infrastructure Health & Safety Association. (2010) Construction Health and Safety Manual. Mississauga, ON.
- Institute of Transportation Engineers. (1999) Transportation and Traffic Engineering Handbook. Washington, D.C.
- Iowa State University.(2002) Synthesis of Best Practice for Increasing Protection and Visibility of Highway Maintenance Vehicles. Ames, IA.
- Mahoney,K.M., Porter,R.J., Taylor,D.R. Kulakowski,B.T. & Ullman,G.L. (2006) Final Report For NCHRP Report 581: Design of Construction Work Zones on High-Speed Highways.Washington,D.C.
- Mahoney,K.M., Porter,R.J., Taylor,D.R. Kulakowski,B.T. & Ullman,G.L. (2007) Design of Construction Work Zones on High-Speed Highways.Washington,D.C.
- Manitoba Infrastructure and Transportation. (2008). Manitoba: Work Zone Traffic Control Manual [Internet]. Winnipeg, MB.
- Michigan Department of Transportation. (2007) Michigan: Maintenance Work Zone Traffic Control Guidelines [Internet]. Lansing, MI.
- Ministry of Transportation – Ontario (MTO). (1995) Turning Orange: Construction Zones in Ontario. RoadTalk. [Internet], June 1995, Vol 15 (3).
- Ministry of Transportation – Ontario (MTO). (1995) Reducing Headlight Glare. RoadTalk. [Internet], June 1995, Vol 1 (3), p. 2.
- Ministry of Transportation – Ontario (2001). *Temporary Conditions Traffic Management; Advance Notification, Advance Warning and Alternative Route Signing for Provincial Highways*

in MTO Central Region. For use on Provincial Highways and other roadways in MTO's Central Region. Downsview, ON. Central Region Traffic Office.

Ministry of Transportation - Ontario (MTO). (2009) Quantm Route Selection: No Stone Left Unturned. RoadTalk. [Internet], Spring 2009, Vol 15 (3), p.1.

Ministry of Transportation - Ontario (MTO). (2009a) Portable Variable Message Signs (PVMS). Best Practices Manual. ON. Advanced Traffic Management Section.

Ministry of Transportation - Ontario (MTO). (2009b) MTO's Designated Sources for Materials. General Requirements for Listing of Vendors and Products. [Internet]. St. Catharines, ON. Design and Contract Standards Office, Ministry of Transportation.

Ministry of Transportation - Ontario (MTO). (2011). Fluorescent Orange Temporary Pavement Markings. Policy Number: 2011-01. St. Catharines, ON. Traffic Office, Highway Standards Branch.

Ministry of Transportation - Ontario (MTO). (2008) Portable Temporary Traffic Signals Policy. Policy Number: 2008-03. [Internet]. St. Catharines, ON. Traffic Office, Ministry of Transportation.

Ministry of Transportation - Ontario (MTO). (2011) Innovative Mobile Work Zone Barrier on Highway 115 Project. RoadTalk. [Internet], Winter 2011, Vol 17 (1), p. 1.

Ministry of Transportation – Ontario (MTO). (2001) Ontario Traffic Manual. Book 7. Temporary Conditions. [Internet] St. Catharines, ON. Ministry of Transportation Ontario.

Ministry of Transportation Ontario (MTO) (2009) Guidelines for Accommodating Cyclists in Construction Zones and Road Closures. Ottawa, ON.

Ministry of Transportation- Ontario (MTO). (2001) Temporary Conditions Traffic Management: Advance Notification, Advance Warning, and Alternative Route Signing. Downsview, ON. Central Region Traffic Office.

Minnesota Department of Transportation. (2005) Minnesota: MUTCD – Temporary Traffic Control [Internet]. Roseville, MN.

Mobile Barriers LLC. (2009-2010) Mobile Barriers ® Mobile Barriers & Protected Areas for: Road & Bridge Construction & Maintenance, Airport Maintenance, Security, Defense and Other Applications. [brochure].

Mobile Barriers LLC. (2007-2012) Mobile Barriers ® Mobile Work Zones Mobile Security. [Internet], <http://www.mobilebarriers.com/>.

- Morales, J.M. (2009) Safe and Effective Use of Law Enforcement Personnel in Highway Work Zones: Pocket Guide. [Internet]. Fredericksburg, VA. American Traffic Safety Services Association.
- National Cooperative Highway Research Program (NCHRP). (2009) Improving the Safety of Mobile Lane Closures. Washington, D.C.
- New Brunswick Department of Transportation. (2009) New Brunswick: Work Area Traffic Control Manual [Internet]. Fredericton, NB.
- Nova Scotia Department of Transportation and Infrastructure Renewal. (2009) Nova Scotia: Temporary Workplace Traffic Control Manual [Internet]. Halifax, NS.
- NZ Transport Agency. (2011) Trials of traffic control devices – Guidelines. Wellington, NZ.
- Ontario, Ministry of Labour. (2003) Fire Fighters Guidance Note # 6-10. Toronto, ON.
- Oregon Department of Transportation. (2011) Oregon: Temporary Traffic Control Manual [Internet]. Salem, OR.
- Province of Nova Scotia. (2006) Traffic Management Guidelines for Emergency Scenes. Halifax, NS.
- Quixote Transportation Safety Inc. (2007) Safe-HitR Product Catalog.
- ResponderSafety.com. (2008) SOP SOG For Your Fire Department Safe Positioning While Operating or Near Moving Traffic.doc [Internet]. USA. Office of Justice Programs, U.S. Department of Justice.
- Road Authority, The. (2011). The Road Authority [Internet], ON. ASI Technologies Inc.
- Science Applications International Corporation American Transportation Research Institute. (2010) Traffic Incident Management Handbook Update. Washington, D.C.
- State of California, Business, Transport and Housing Agency, Department of Transportation. (2006) California Manual on Uniform Traffic Control Devices (2006) [Internet]. Sacramento, CA.
- Transportation Association of Canada. (1995). Section U.D.18 Urban Supplement to the Geometric Design Guide for Canadian Roads.
- Transportation Association of Canada. (1998) Manual of Geometric Design Standards for Canadian Roads. Ottawa. Transportation Association of Canada.
- Transportation Research Board of the National Academies. (2007) Making Night Work Zones Safe Reports 475 and 476; CRP-CD-50. [Internet]. USA. National Cooperative Highway Research Program.
- Transportation Research Board. (1994) Highway Capacity Manual, 3rd Edition. Washington, D.C.

U.S. Department of Transportation (1994) Roadway Delineation Practices Handbook. Washington, D.C. Federal Highway Administration.

U.S. Department of Transportation, Federal Highway Administration. (2009) Traffic Control Concepts for Incident Clearance. Washington, D.C.

U.S. Department of Transportation, Federal Highway Administration. (2009) US: Manual on Uniform Traffic Control Devices - MUTCD (FHWA) [Internet]. Washington, D.C.

U.S. Department of Transportation. (2009) Manual on Uniform Traffic Control Devices for Streets and Highways. [Internet]. Washington, D.C. Federal Highway Administration.

Ullman, G.L., Finley, M.D., Bryden, J.E., Srinivasan, R. & Council, F.M. (2008) Traffic Safety Evaluation of Nighttime and Daytime Work Zones. Washington, D.C.

Washington State Department of Transportation. (2012) Work Zone Traffic Control Guidelines [Internet]. Olympia, WA.