

Amendment to the Manitoba Infrastructure and Transportation *Work Zone Traffic Control Manual* respecting the establishment of Designated Construction Zones in Manitoba

BACKGROUND

In December, 2013, the Government of Manitoba passed Highway Traffic Act (HTA) amendments that double the set fines for speeding in a designated construction zone (DCZ). The amendments authorize double fines for speeding:

- Whether or not there are workers/equipment present; and
- Whether or not there is a reduction in the maximum speed within the DCZ.

The amendments require traffic authorities, and contractors working on their behalf, to establish DCZs, and to identify them using the signage prescribed in the Designated Construction Zones Regulation.

In addition, the '60 When Passing Workers' sign or any similar sign that links a speed reduction to the presence or absence of workers/equipment is now prohibited from use on all highways throughout Manitoba.

As a result of the introduction of these regulations, several Work Zone Policies, TMP's and STMP's contained in Manitoba Infrastructure and Transportation's *Work Zone Traffic Control Manual* will need to be revised to comply with the HTA amendments. Until such time as these revisions can be completed and a new edition of the WZTCM issued, this amendment shall provide direction with respect to the establishment of work zones on projects under MIT jurisdiction.

DESIGNATED CONSTRUCTION ZONES

A traffic authority/contractor must establish a work site as a DCZ if the work being undertaken on a road meets ALL of the following conditions:

1. Work is on the roadway portion of a highway, i.e. the area of a highway where vehicles travel, this does not include the shoulder, sidewalk or ditch/median;
2. Work is 4 hours or more in duration;
3. Work is on a paved roadway; and
4. Work is on a road where the maximum speed is 80 km/h or more.

If one or more of the above conditions does not apply to the work being undertaken, then the traffic authority is not required to establish a DCZ. For example, a traffic









authority would not be required to establish a DCZ if the work is taking place on a gravel road; or on a road where the regular maximum speed is 50 km/h; or when the work is on the shoulder/sidewalk.

Optional DCZ's

A traffic authority has the option of establishing a work site as a DCZ if doing so will enhance the safety of workers and other road users. To do this, the work being undertaken must be road construction, reconstruction, widening, improvement, repair, or other similar work in relation to the road.

DCZ Signage

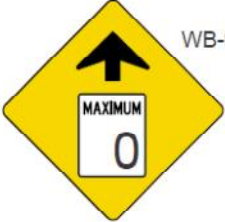
A traffic authority/contractor is responsible to erect/place the approved signage shown below:

 MC-1 D  MC-1 DF  MC-1 DB <p style="text-align: center;">900mm x 900mm : 2 - LANE ROADWAY 1200mm x 1200mm : 4 - LANE ROADWAY</p>	 MR-179  MR-179 F <p style="text-align: center;">600mm x 600mm : 2 - LANE ROADWAY 900mm x 900mm : 4 - LANE ROADWAY</p>		
	 RB-1 <p style="text-align: center;">600mm x 750mm : 2 - LANE ROADWAY 900mm x 1200mm : 4 - LANE ROADWAY</p>	 WB-9 <p style="text-align: center;">900mm x 900mm : 2 - LANE ROADWAY 1200mm x 1200mm : 4 - LANE ROADWAY</p>	
	 TC-4 DB <p style="text-align: center;">900mm x 900mm 2 - LANE OR 4 - LANE ROADWAY</p>		
<p><u>Designated Construction Zones</u> Sign Sizes based on Type of Roadway</p>		<p>Page 1 of 1</p> <p>2014-05</p>	

Designated Construction Zone Sign

The beginning of a DCZ must be identified with the 'Designated Construction Zone' sign. Drivers must have an unimpeded view of the sign. This sign will replace the Construction Area sign (MC-1) or the "Men and Equipment Working sign (TC-2) in the TMP's and STMP's contained in this Manual. In accordance with MIT's Standard Construction Specifications, Construction Area Signs are also to be installed at the intersection of every Provincial Trunk Highway or Provincial Road that enters onto the project.

Construction Ends Sign

The end of a DCZ must be marked with the 'Construction Ends' sign (TC-4 or TC-4 DB). Drivers must have an unimpeded view of the sign.

Speed Fines Double Warning Sign

At least one 'Speed Fines Double' sign (MR-179) must be placed within a DCZ and be no more than 150 m after the 'Designated Construction Zone' sign which marks the beginning of the DCZ.

A traffic authority/contractor may place more than one 'Speed Fines Double' sign in a DCZ to heighten driver awareness. The sign may also be used to mark a portion of road within the DCZ that intersects with another roadway. For example, where a high volume road intersects with a DCZ, the traffic authority/contractor may use the 'Speed Fines Double' sign to warn drivers entering the DCZ.

Bilingual Traffic Signing

Bilingual Traffic Signing Areas as identified in Policy 900-A-7 of this Manual shall be signed in both official languages using either the bilingual sign, or separate English and French signs with the French sign installed the English sign, at a distance of approximately 30m.

SPEED REDUCTIONS

Only traffic authorities are authorized to approve speed reductions in work zones. A traffic authority may reduce the maximum speed in all or part(s) of a work zone. Longer work zones may have a number of reduced speed areas to enhance the safety of workers and road users.

In the past, traffic authorities/contractors commonly used the '60 When Passing Workers' sign to inform drivers to reduce their speed. This sign, and any similar sign that links a speed reduction to the presence or absence of workers/equipment, is now *prohibited* from use on all highways throughout Manitoba. As a result **Policy 900-C-7** in

this Manual is no longer valid. Furthermore, any TMP or STMP in this Manual using the “60 When Passing Workers” sign shall be modified to eliminate the use of this sign.
Speed Reduction Signage

Traffic authorities/contractors must now identify all maximum speed reductions in work zones using the sequence of regulatory signage detailed below:

Reduced-Speed Ahead Warning Sign

- A reduced-speed ahead warning sign (WB-9) is to be placed in advance of the speed reduction.



Maximum Speed Signs

- The beginning of a reduced-speed area must be identified using a regulatory 'Maximum Speed' sign (RB-1).

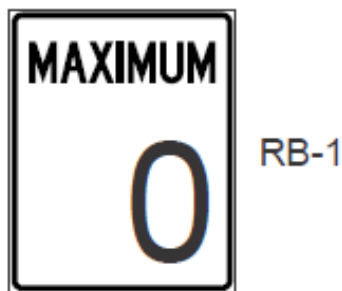

- The end of a reduced-speed area must be identified using a regulatory 'Maximum Speed' sign (RB-1) to inform drivers that they may increase their speed to the normal posted maximum.
- All existing regulatory speed signs within the reduced speed zone must be covered.

Approved Speed Reductions

As outlined in Policy 900-C-6 of this Manual, The Director of Traffic Engineering has the delegated authority to set speed limits within construction and maintenance areas on provincial highways.

The following common work zone conditions and hazards have been granted blanket pre-approval for regulatory speed reductions. All other conditions requiring a speed reduction must be approved in writing by the Director of Traffic Engineering (contact MIT's Traffic Engineering Branch at 204-945-3781).

WORK ZONE CONDITION / HAZZARD	PRE-APPROVED SPEED LIMIT
Workers are located in close proximity to traffic (up to a maximum of 12m from an open traffic lane)	60 Km/h
A significant unprotected roadside hazard (e.g. excavation area) is located within the clear zone	70 Km/h
The conversion of a 4-lane divided highway to 2 lane/2 way operation	80 Km/h

A written record detailing the location, time of installation and time of removal of all regulatory speed reductions must be maintained by the traffic authority/contractor.

The use of reduced speed limit signs must be limited to those specific sections of highway where the pre-approved condition or hazard exists. They must **NOT** be used throughout the project unless the pre-approved condition or hazard dictates. Speed limit signs must be removed immediately when the conditions change or hazards no longer exist.

MODIFICATIONS TO EXISTING TMP'S

Until an updated *Workzone Traffic Control Manual* is issued, the user of this manual will be required to modify the TMP's and STMP's contained herein to meet the new regulatory requirements outlined in this amendment. The following three examples are provided to illustrate typical changes required in a unilingual DCZ, in a bilingual DCZ, and in a non DCZ workzone. Sign spacing shall conform to the tables contained within the existing TMP. Enquiries related to the modification of TMP's or STMP's should be directed to Traffic Engineering Branch (204) 945-3781.

DESIGNATED CONSTRUCTION ZONE

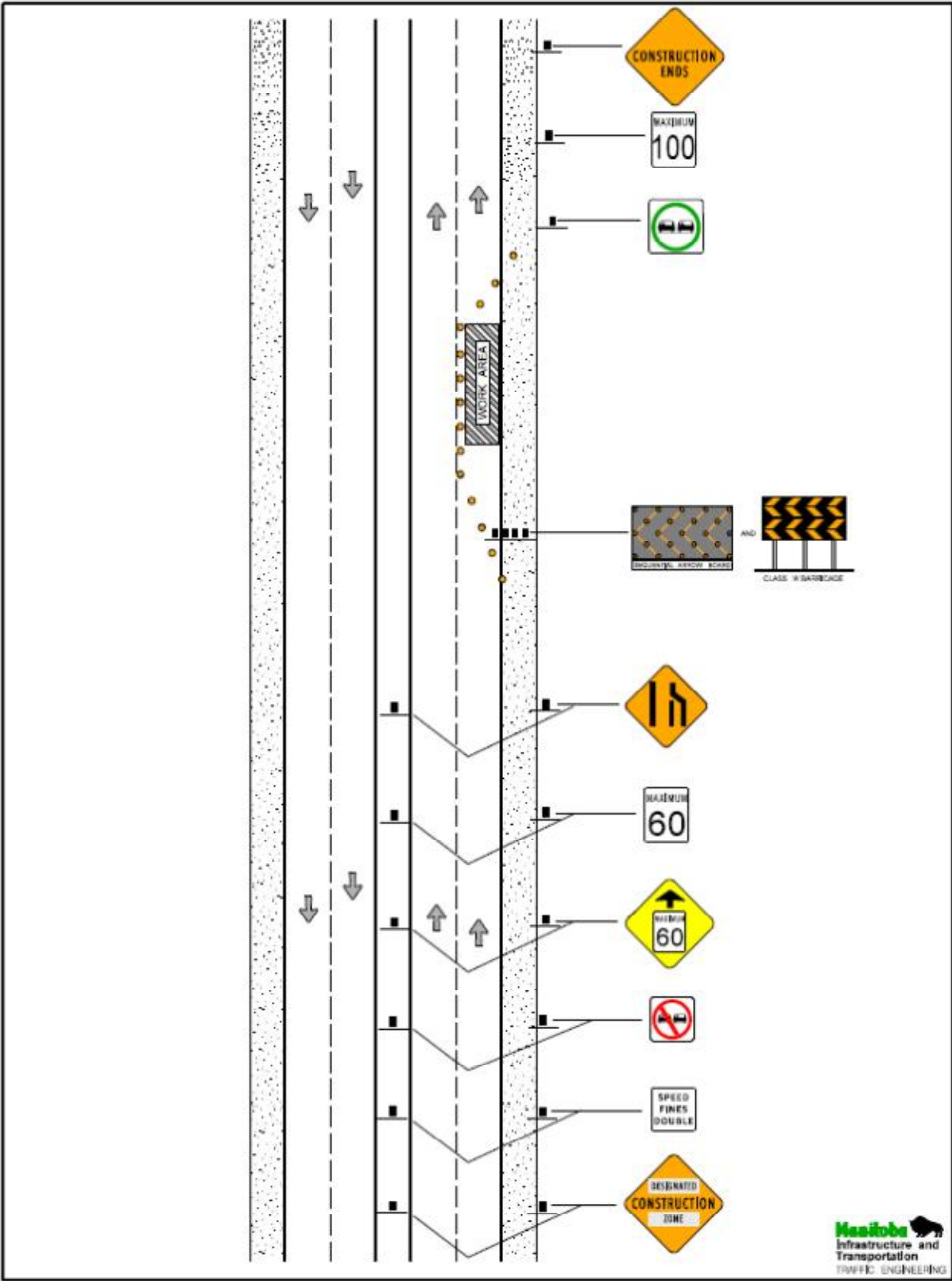

DESIGNATED CONSTRUCTION ZONE - BILINGUAL AREA

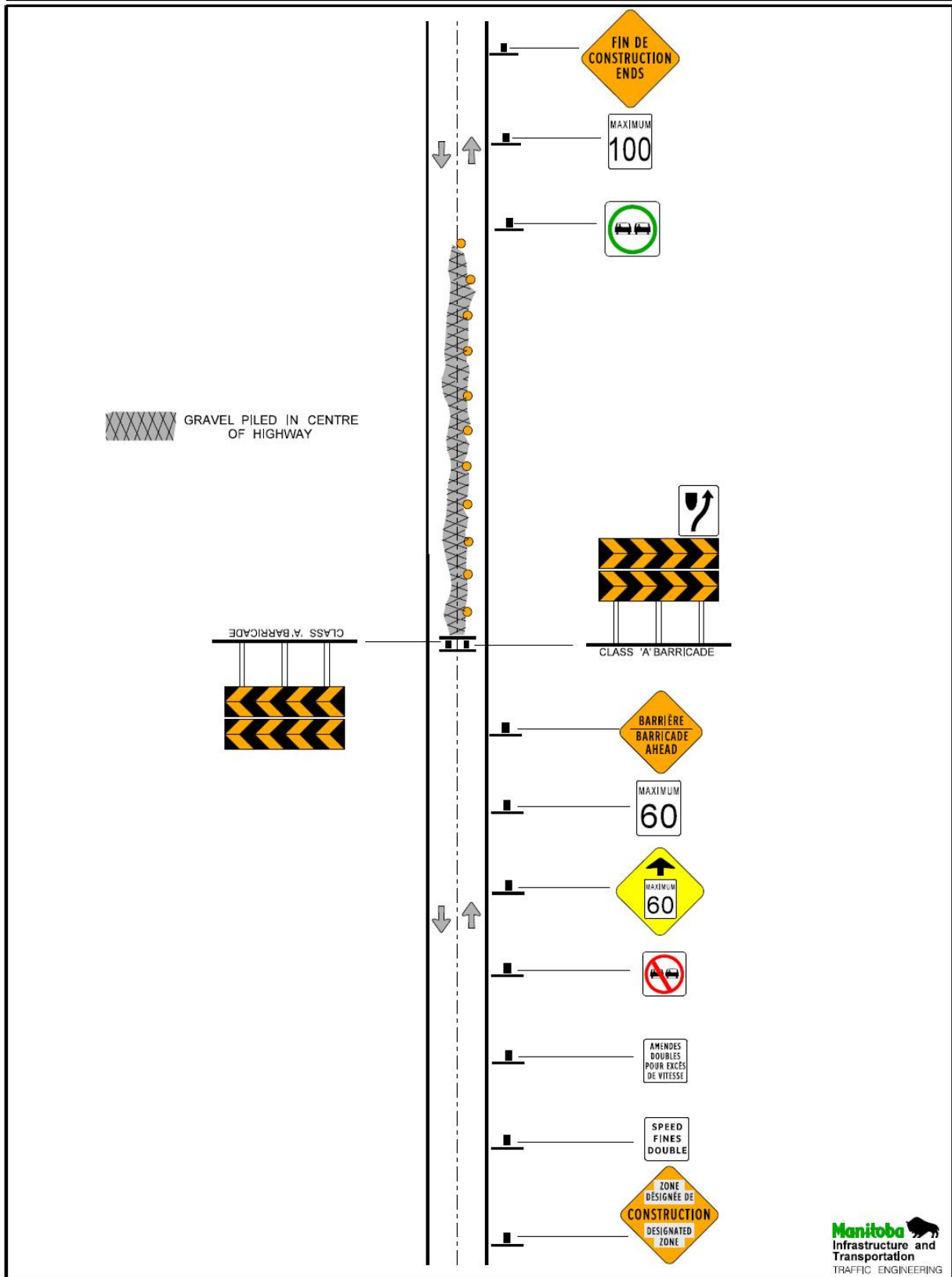

SPEED REDUCTION NON-DESIGNATED CONSTRUCTION ZONE

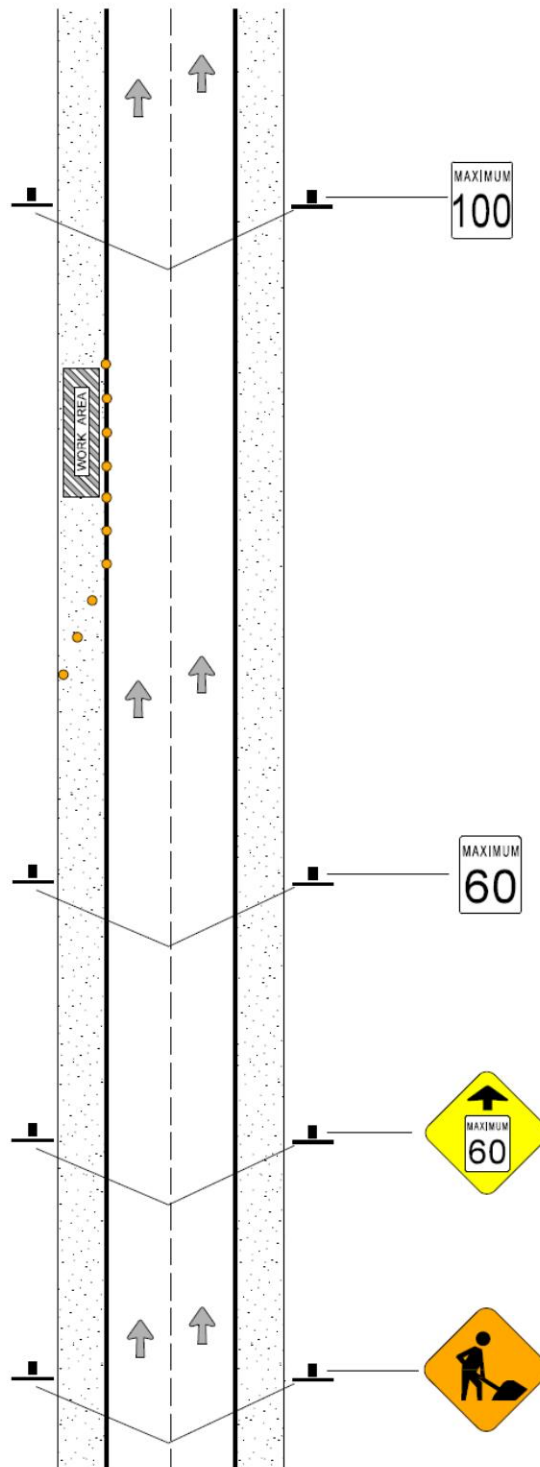



DRAFT

Manitoba Infrastructure and Transportation

Work Zone Traffic Control Manual

Provincial Roads
and
Provincial Trunk Highways



Manitoba 
Infrastructure and
Transportation
Traffic Engineering

EDITION 2013

INTRODUCTION

WORK ZONE TRAFFIC CONTROL MANUAL

This manual is intended to provide **minimum standards** for the protection of road users and workers during temporary works relating to highway maintenance and construction, including utility and other operations. This manual should provide a **single source** for traffic control standards for use on Manitoba's highways. Over 1000 "hard copies" of this manual were circulated since its initial printing in 2000. It has been available "on line" since March 2002.

Please contact the Traffic Engineering Branch at (204) 945-3781 for advice and recommendations on dealing with traffic control situations not included in this manual, or where the standards in the manual fail to adequately control traffic or protect workers.

The following revised standards are based on **best practices** in Manitoba and in other jurisdictions. They have been revised, refined and adjusted in actual field use. However, they are meant to be open to change and improvement, and we continue to welcome your suggestions, comments and criticisms.

Traffic controls for temporary conditions often represent a compromise between the time and cost to erect and maintain the necessary devices, and the need to get the job done. We hope this manual strikes a balance between those conflicting requirements, while providing the necessary protection to both workers and motorists.

This 2011 Revision incorporates a few changes and improvements.

Director, Traffic Engineering Branch

WORK ZONE POLICIES

TABLE OF CONTENTS

A

900-A-1	Introduction
900-A-2	General Guidelines
900-A-3	Fundamental Principles
900-A-4	Worker Visibility on Roadway
900-A-5	Vehicle Visibility on Roadway
900-A-6	Survey Crew Traffic Control
900-A-7	Bilingual Traffic Signing (incl. Bilingual Signing Area Maps)

B

900-B-1	Work Zone Requirements
900-B-2	Flagpersons
900-B-3	Signs
900-B-4	Sign Placement
900-B-5	Portable Signs
900-B-6	Optional Sign Mounting Locations
900-B-7	Sign Spacing
900-B-8	Passing Restrictions
900-B-9	Barricades
900-B-10	Gateway Assembly
900-B-11	Hazard Markers
900-B-12	Channelizers and Delineators
900-B-13	Sign Reflectivity
900-B-14	Maintenance
900-B-15	Enhancement
900-B-16	Protection from Vehicular Traffic
900-B-17	Flagman for Stringline Person
900-B-18	Flagman for Worker Installing Temporary Overlay Marker
900-B-19	Working Near Railway Crossings
900-B-20	Traffic Control – Paving Operations
900-B-21	Temporary Storage of Objects in Right-of-Way

C

900-C-1	Traffic Management Plans
900-C-2	Traffic Control Coordinator
900-C-3	Work Zone Components
900-C-4	Transition Tapers
900-C-5	Installation and Removal of Traffic Control Devices
900-C-6	Speed Limits in Construction & Maintenance Areas
900-C-7	60 km/h When Passing Workers Sign
900-C-8	Pilot Vehicle Traffic Control

D

900-D-1 Traffic Control on Low Speed Roads

E

900-E-1 Off-Road Operations

900-E-2 Shoulder Work

900-E-3 Bridge Inspection

F

900-F-1 Mobile Operations

900-F-2 Fast Moving Operations - Benkelman Beam (Pavement Deflection)

900-F-3 Fast Moving Operations - Soil Drill Truck/Coring Vehicle

900-F-4 Fast Moving Operations - Profilograph Unit

900-F-5 Fast Moving Operations/Nuclear Density Testing

900-F-6 Fast Moving Operations – Hi-Low Vehicle

900-F-7 Fast Moving Operations - Self Propelled Asphaltite Unit

900-F-8 Mobile Operations - Maintenance Graveling

900-F-9 Traffic Signal Repairs

900-F-10 Pavement Marking Operations

900-F-11 Sealcoat Operations

G

900-G-1 Short Term Lane Closures

900-G-2 Daylight Detour - Flagpersons Required Continuously

H - Work Zone Traffic Management - Long Term

900-H-1 Traffic Diversion - Long Term

900-H-2 Four Lane Divided Highway - Conversion to 2L2W Operation

900-H-4 Route Detour Signing

900-H-5 Truck Entrance Signing

900-H-6 New 4-Lane Divided Highway Intersection Traffic Control

900-H-7 Overhead Wires

TMP Index – Sign Layout Drawings (Traffic Management Plan Series)

STMP Index – Sign Layout Drawings (Special Traffic Management Plan Series)

SS - Traffic Sign Schedule

SSB - Traffic Sign Schedule (Bilingual Signs)

WORK ZONE POLICIES ALPHABETICAL INDEX

Apparel – Department Employees	900-A-4
Asphalite Unit – Fast Moving Operations	900-F-7
Barricades	900-B-9
Benkelman Beam – Fast Moving Operations	900-F-2
Bench Cuts	900-B-11
Bilingual Traffic Signing	900-A-7
Bridge Inspection	900-E-3
Channelizers - Types	900-B-12
Coordinator - Traffic Control	900-C-2
Detour – Daylight	900-G-2
Detour Signing	900-H-4
Devices – Basic Requirements	900-B-1
Devices – Enhanced Traffic Control	900-B-15
Devices – Maintenance	900-B-1
Devices – Removal	900-C-5
Drill Truck – Fast Moving Operations	900-F-3
Drums	900-B-12
Fast Moving Operations – Asphalite Unit	900-F-7
Fast Moving Operations – Benkelman Beam	900-F-2
Fast Moving Operations – Drill Truck/Coring Vehicle	900-F-3
Fast Moving Operations – Hi-Low Vehicle	900-F-6
Fast Moving Operations – Nuclear Density	900-F-5
Fast Moving Operations – Profilograph	900-F-4
Flagperson	900-B-2
Four-Lane Divided Highway Intersections (new locations)	900-H-6
Four-Lane to Two-Lane Two Way Conversion	900-H-2
Gateway Assembly	900-B-10
Gravel Windrows	900-B-11
Hazard Markers	900-B-11
Hi-Low Vehicle – Fast Moving Operations	900-F-6
Highway Traffic Act	900-A-1
Lane Closure – Long Term	900-H-1
Lane Closure – Short Term	900-G-1
Maintenance Gravelling – Mobile Operation	900-F-8
Mobile Operation – Maintenance Gravelling	900-F-8
Nuclear Density – Fast Moving Operations	900-F-5
Overhead Wires (signing)	900-H-7
Passing Restrictions	900-B-8
Pavement Edge Drop Off	900-B-11
Pavement Marking Operation	900-F-10
Pilot Vehicle Traffic Control	900-C-8
Plastic Drums	900-B-12
Poly Posts	900-B-12
Profilograph – Fast Moving Operations	900-F-4
Railways, Working Near	900-B-19
Retroreflectivity	900-B-13
Sealcoat Operations	900-F-11
Signs	900-B-3
Signs – Maintenance	900-B-14

Signs – Placement	900-B-4
Signs – Portable	900-B-5
Signs – Spacing	900-B-7
60 km/h When Passing Workers Signing	900-C-7
Speed Limits	900-C-6
Stringline Installation	900-B-17
Survey Crew Signing	900-A-6
Temporary Overlay Marker Installation	900-B-18
Temporary Storage of Objects in Right-of-Way	900-B-21
Traffic Control - Coordinator	900-C-2
Traffic Management Plans	900-C-1
Traffic Signal Repairs	900-F-9
Transition Tapers	900-C-4
Truck Entrance Signing	900-H-5
Vehicles - Visibility	900-A-5
Visibility - Clothing	900-B-16
Visibility - Vehicles	900-A-5
Work Zone - Components	900-C-3
Work Zone – Low Speed	900-D-1
Work Zone – Mobile	900-F-1
Work Zone – Off Road Work	900-E-1
Work Zone – Shoulder Work	900-E-2
Work Zone Areas - Activity	900-C-3
Work Zone Areas - Advance Warning	900-C-3
Work Zone Areas - Buffer	900-C-3
Work Zone Areas - Termination	900-C-3
Work Zone Areas - Transition	900-C-3

Purpose

The Manitoba Infrastructure and Transportation provides uniform policies and standards for traffic control devices in work zones on or adjacent to Provincial Trunk Highways and Provincial Roads. Traffic control devices include signs, delineators, channelizers, barricades, pavement markings, lighting devices, flagpersons/flagging equipment, and any other device placed upon a public roadway which warns motorists of changing conditions or provides for the safe movement of traffic. All organizations performing work on or adjacent to a highway are required to install and maintain such traffic control devices as identified in this policy/standard as necessary to provide a safe work environment and ensure safe passage for the travelling public.

Policy

All employees, contractors, and utilities doing work on or adjacent to Provincial Trunk Highways and Provincial Roads are required to implement and maintain a Work Zone Traffic Management Plan consistent with the Policies and Standards outlined herein.

Standard

The standards contained herein are minimum standards and may have to be increased to accommodate traffic safely.

Modifications must be approved by the Director of Traffic Engineering or his representative before plans are implemented in the field to ensure that the safety of workers and motorists is not compromised.

Driver Expectations

Primarily because of driver expectations, safety in construction and maintenance zones is difficult to achieve effectively. Although most motorists understand that unusual roadway conditions may be encountered, the general expectation is that evasive actions or significant reductions in vehicle speed will not be required.

RECOMMENDED: "ORIGINAL SIGNED BY" _____
Director, Traffic Engineering

APPROVED: "ORIGINAL SIGNED BY" _____
Executive Director
Highway Engineering

While maintenance and construction activities can be unexpected, most maintenance and construction zones are relatively static, providing the traffic authority with the opportunity to provide effective warning or guidance through the zone.

Effectiveness of Traffic Control Devices

For the most part, this warning or guidance can be provided through the use of standard traffic control devices. To achieve optimum effectiveness, the traffic control at all maintenance and construction zones **must** be regularly reviewed and enhanced where required:

Motorist safety is generally most compromised in construction and maintenance zones during hours of darkness. Consequently, the adequacy of traffic controls in these areas, particularly detours, **must** be regularly reviewed, especially at night to ensure that the intended traffic control is not compromised. This review should include an assessment of:

- sign reflectivity
- sign lateral, longitudinal and vertical position
- relationships between other temporary or permanent traffic control devices

Only those temporary signs and devices that are approved by the Department may be used on the highway right-of-way. All signs and devices must be reflectorized to show the same colour by night as by day, and the reflectivity levels must be maintained by cleaning or replacing signs, etc. when necessary.

Special emphasis is required when a speed drop greater than 30 km/h is encountered, between the normal highway travel speed and the speed necessary to smoothly and safely traverse a detour or construction area.

Positive Guidance

Where possible, positive guidance (pavement markings, plastic drums, cones, delineation, etc.) must be provided through a work area or detour. Under all circumstances this positive guidance should always create a consistent visual image. This is created by ensuring both uniform spacing and uniform offsets of the delineators/channelizers. If uniform offsets are not possible, smooth transitions from one offset to another must be used to avoid abrupt changes in the visual roadway alignment.

As oncoming headlights may obscure the change in alignment, special emphasis such as illumination, positive guidance, or flashing arrow boards may be required at the transition from four-lane divided to a two-lane two-way (2L2W) highway where a change in alignment occurs.

To obtain adequate impact, under some circumstances, traffic control devices (signs, pavement markings, etc.) may be enhanced by:

- oversizing signs
- supplementing with fluorescent orange flags
- removing unnecessary existing signs (route markers, guide signs, etc.)
- roadway illumination

Under some circumstances, the existing speed limit signs in the work area should be removed or covered.

When one side of a divided highway is closed and the other side is used to carry two-lane, two-way (2L2W) traffic, the opposing traffic flows must be separated from each other by some form of a physical barrier such as cones, delineator posts, plastic drums or portable concrete barriers or plastic water-filled barriers.

Requirements of The Highway Traffic Act (HTA):

- Section 74 - "All contractors' and Department vehicles, unless physically engaged in maintaining or constructing a highway, must comply at all times with the rules of the road as established in The Highway Traffic Act."
- Section 77(7) - "The closest construction traffic control device shall not be further than 450 m from the start of the work area."
- Section 77(9) - "Construction traffic control devices shall be removed when the work is sufficiently completed to render it unnecessary for the devices to remain in place."
- Section 81 - Only those traffic control devices approved by the Highway Traffic Board or by the Director of Traffic Engineering may be used on provincial highways.

Lane Widths

Detours with travel speeds of 70 km/h or greater should have clear lane widths of at least 3.7 m, excluding shoulders.

Traffic Control Device: **Work Zone**

Date of Revision: **March 15, 2002**

Division:

Subject: **General Guidelines**

Page **1 of 2**

Purpose

The Policies and Standards developed herein establish guidelines to be observed in developing Traffic Management Plans (TMP) for construction and maintenance work zones. These guidelines are directed to the safe and expeditious movement of traffic through construction and maintenance work zones and to the safety of the workforce performing the operations.

The Policies/Standards also sets forth guidelines pertaining to the use, installation, and maintenance of the various traffic control devices required for roadway construction, maintenance, and utility work, and prescribes standards where possible. These guidelines deal with signs, delineators, channelizers, barricades, pavement markings, lighting devices, and flagpersons/flagging equipment. Several typical situations are included in the Policies/Standards that illustrate the proper application of standard traffic control devices.

Policy

The Policies and Standards developed herein must be used as the primary guide in developing Traffic Management Plans for construction and maintenance work zones. The requirements of future Departmental policy directives, statutory/regulatory provisions, and requirements detailed in specifications of work by contract will override these basic guidelines as applicable. The users of these Policies/Standards are responsible for being aware of any special considerations or requirements pertaining to particular situations.

Standard

Since it is not practical to prescribe detailed application standards for all situations that may arise, it is emphasized that **only minimum desirable standards for normal situations are presented**. When unusual or hazardous conditions prevail, Traffic Engineering Branch must be consulted before changes are made to Traffic Management Plans.

RECOMMENDED: "ORIGINAL SIGNED BY"
Director, Traffic Engineering

APPROVED: "ORIGINAL SIGNED BY"
Executive Director
Highway Engineering

The general guidelines outlined in the Policies/Standards are applicable to all Provincial Trunk Highways and Provincial Roads. However, the traffic control devices guidelines must be interpreted with respect to the specific traffic characteristics of each location. The level of work zone protection should be based on roadway speed, traffic volume, available sight distance, duration of operation, and hazard exposure. Traffic conditions in urban areas are generally characterized by low speeds, wide ranges of traffic volume, limited manoeuvring room, frequent turns and cross movements, pedestrian traffic, and other obstructions. Rural highways are typically characterized by higher speeds, lower volumes, greater manoeuvring room and less interference from turning vehicles, pedestrians, and encroachments.

Although each situation must be dealt with individually, conformity with the general provisions established herein is required. Whenever possible, identical conditions should be similarly treated. Minor variations may be necessary due to field conditions or other governing factors. In such instances, engineering judgement must be used to select the most appropriate devices.

Traffic Control Device: **Work Zone**Date of Revision: **March 15, 2002**

Division:

Subject: **Fundamental Principles**Page **1 of 3**

Purpose

Construction and maintenance work zones often present the motorist with unexpected or unusual situations. Consequently, special care must be taken when applying traffic management techniques to these areas. The following principles and procedures contribute to the safety of motorists and workers in construction and maintenance work zones.

Policy

All employees, contractors and utilities doing work on, or adjacent to, highways are required to follow this set of Fundamental Principles when establishing Work Zone Traffic Management Plans.

Standard

Traffic Safety

Traffic safety in work zones must be an integral and high priority element of every project from planning through to completion of the work. The safety of motorists, pedestrians, and workers must be kept in mind at all times.

The safety principles governing the design of permanent roadways should also govern the design of construction and maintenance sites. **The objective should be to route traffic through the work zone using geometry and traffic control devices comparable to those used in normal highway situations.**

A Traffic Management Plan (TMP), in sufficient detail to reflect the complexity of the work project, must be prepared, understood by all responsible parties, and put into operation before the site is occupied.

Construction equipment or vehicles must not be parked so as to obscure or in any way block motorists' view of traffic control devices. Vehicles may only be parked on the roadway if they are being used in the performance of the work.

RECOMMENDED: "ORIGINAL SIGNED BY" _____
Director, Traffic Engineering

APPROVED: "ORIGINAL SIGNED BY" _____
Executive Director
Highway Engineering

The travelled way must be kept free of foreign objects such as spilled earth, rock, timber, and other items that may fall from construction vehicles. Materials spilled near or dropped along or across any public travelled roadway must be removed immediately.

Traffic must be channelized with pavement markings, traffic cones, flexible posts, breakaway posts, and other lightweight devices that yield when struck.

To accommodate errant vehicles or emergencies, construction equipment, material and debris must be stored so as to provide an unobstructed roadside recovery area, as wide as practicable.

Traffic Movement

To minimize the disruption of service, traffic movement through work zones should be inhibited as little as possible.

Reduced speed zoning should be avoided as much as possible and must be verified by a traffic engineering analysis.

Abrupt or frequent changes in geometry such as lane narrowing, dropped lanes or transitions that require rapid manoeuvres should be avoided. Except as specified in the TMP, the width and number of lanes available to traffic must not be reduced.

Construction time should be minimized to reduce motorist exposure to potential hazards.

Motorist Guidance

Motorists should be guided in a clear and understandable manner while approaching and traversing construction and maintenance work zones.

Adequate warning, delineation and channelization through the use of appropriate traffic control devices must be provided to assure the motorist of positive guidance throughout the work zone. The traffic control devices must be effective under varying conditions of light and weather to ensure traffic guidance is maintained at all times.

For both long and short duration construction and maintenance projects, inappropriate traffic control devices must be covered or removed to avoid misleading the motorist. On projects of less than several days duration, existing pavement markings may be left in place, but only if the intended vehicle paths can be properly delineated.

Flagging procedures, when used, provide positive guidance to the motorist when travelling through the work zone. The complexity of the work being performed and the TMP will dictate the use of flagpersons.

Operations

Work zones must be regularly monitored under varying conditions of traffic volume, light, and weather to ensure that traffic management measures are operating effectively and that all traffic control devices are clearly visible, clean, and in good repair.

Work zone accident records must be maintained and periodically analyzed to help identify conflicts and to guide officials in improving operations.

During periods of inactivity, including nights, weekends, and holidays, traffic control devices not required for traffic management must be covered or removed. All traffic control devices must be removed when no longer applicable.

Traffic Control Device: **Work Zone**

Date of Revision: **March 15, 2005**

Division:

Subject: **Worker Visibility on Roadway**

Page **1 of 1**

Purpose

All Manitoba Infrastructure and Transportation workers who are on the highway or on the right-of-way are exposed to the dangers of traffic. The key to maximum safety while on the roadway is **visibility**.

Policy

All employees of the Department are required to wear Department approved high visibility clothing or approved flagperson's vest and hat whenever they may be exposed to traffic or construction equipment.

Standard

Every employee of the Department who is exposed to traffic will be provided with and wear high-visibility safety apparel that complies with the requirements of CSA Standard Z96-02 High-Visibility Safety Apparel.

This safety equipment must be worn **at all times** when employees are in a situation where they may be exposed to traffic.

Employees have the option to purchase other Department approved high visibility clothing.

RECOMMENDED: "ORIGINAL SIGNED BY"
Director, Traffic Engineering

APPROVED: "ORIGINAL SIGNED BY"
Executive Director
Highway Engineering

Traffic Control Device: **Work Zone**

Date of Revision: **March 15, 2002**

Division:

Subject: **Vehicle Visibility on Roadway**

Page **1 of 1**

Purpose

All construction and maintenance vehicles that are parked on the highway or on the right-of-way create a hazard for motorists. The key to maximum safety while on the roadway is **visibility**.

Policy

All vehicles of the Manitoba Infrastructure and Transportation, contractors, consultants, or utility companies that are required to park on the road in order for the users to conduct operations on the highway must be equipped with visibility enhancing lighting as defined by Mechanical Equipment Services.

Standard

Every vehicle of the Department, contractors, or utility companies that may be exposed to traffic must be equipped with an approved lighting system. This safety equipment must be in use **at all times** when the vehicle is in a situation where it might pose a hazard to motorists.

Individual Regions or Branches may choose to provide vehicles with higher standard lighting systems for the vehicles in their fleet based on the frequency and nature of exposure.

RECOMMENDED: "ORIGINAL SIGNED BY" _____
Director, Traffic Engineering

APPROVED: "ORIGINAL SIGNED BY" _____
Executive Director
Highway Engineering

Traffic Control Device: **Work Zone**

Date of Revision: **March 15, 2002**

Division:

Subject: **Survey Crew Traffic Control**

Page **1 of 2**

Purpose

The nature of traditional surveying operations may require personnel to work anywhere outside or within the right-of-way, and for some operations, on the roadway surface or even down the centreline.

Motorists must be adequately warned and regulated for the protection of **workers**. (In many other highway work operations, protection of the **motorist** plays the major part in traffic control strategies.)

Policy

Survey crews must warn traffic by the use of the SURVEY CREW sign (TC-3), supplemented by MAXIMUM 60 WHEN PASSING WORKERS sign (MR-96), or FLAGMAN AHEAD sign (TC-21) as indicated by the following Table I.

Table I

SURVEY CREW SIGNING	
Location of Workers	Required Traffic Control
outside right-of-way	Nil
within right-of-way, off shoulder	TC-3
on shoulder, with infrequent highway crossing	TC-3 and MR-96
on roadway surface	TC-3 and TC-21, with flagperson* per approach direction

* Note that when flagperson is required (except for isolated, occasional flagging requirements) the FLAGMAN AHEAD sign may supplement OR REPLACE the MAXIMUM 60 WHEN PASSING WORKERS.

i.e. TC-3 and TC-21
 OR
 TC-3 and TC-21 and MR-96

RECOMMENDED: "ORIGINAL SIGNED BY" _____
 Director, Traffic Engineering

APPROVED: "ORIGINAL SIGNED BY:" _____
 Executive Director
 Highway Engineering

Standard

This is a minimum standard. Unusual conditions such as high traffic volumes, high traffic speeds, geometric constraints, and sight restrictions (hills, curves, dust, etc.) may require additional signing.

Where signing is required, survey crews must always be visible to motorists from the nearest survey crew signing sequence, and in any case crews must work no further than 1.5 km away from nearest signing.

Survey crews on right-of-way must be properly attired in flagperson's vest or approved fluorescent orange jacket and approved headgear.

The flagperson should be positioned between 30 and 50 m in advance of personnel on the roadway.

The flagperson must be trained, and properly attired in flagperson's vest and approved headgear with approved flagperson's stop/slow paddle or fluorescent red flag.

Survey crew vehicles parked on shoulder must have four-way flashers operating. Amber flashers are required in construction areas. Where possible, the vehicle should be parked outside the shoulder line on an approach or service road. **In no case should the vehicle be parked adjacent to workers or a flagperson so that it blocks the escape route from an approaching errant vehicle.**

MAXIMUM 60 WHEN PASSING WORKERS signs are not to be used in areas with speed limits less than 60 km/h.

All signs should be placed no closer than 30 m from other **existing** signing, for maximum effectiveness of **all** signing.

Where more than one sign is required, i.e. SURVEY CREW and MAXIMUM 60 WHEN PASSING WORKERS or FLAGMAN AHEAD, these signs should normally be spaced 150 m apart on high speed highways, and 50 m in lower speed urban areas. Portable Speed Reporting signs may be used to supplement MAXIMUM 60 WHEN PASSING signs at the discretion of the Engineer.

Traffic Control Device: **Work Zone**

Date of Revision: **March 15, 2002**

Division:

Subject: **Bilingual Traffic Signing**

Page **1** of **11**

Purpose

The province's French Language Services Policy includes a commitment to provide bilingual (English/French) traffic signing for motorists on specified provincial routes.

Policy

Department construction and maintenance projects will include the use of bilingual highway construction signs on all Provincial Trunk Highways and Provincial Roads that lie within the "Bilingual Traffic Signing area" in Manitoba.

Generally, all of the highway construction signs with verbal messages will be affected by this policy.

The French sign shall be installed behind the English sign, at a distance of approximately 30 m.

RECOMMENDED: _____
Director, Traffic Engineering

APPROVED: _____
Executive Director
Highway Engineering

NOTE:
 IN BILINGUAL TRAFFIC SIGNING AREAS, THE
 FRENCH SIGNS ARE TYPICALLY INSTALLED
 30 m AFTER THEIR ENGLISH COUNTERPARTS.

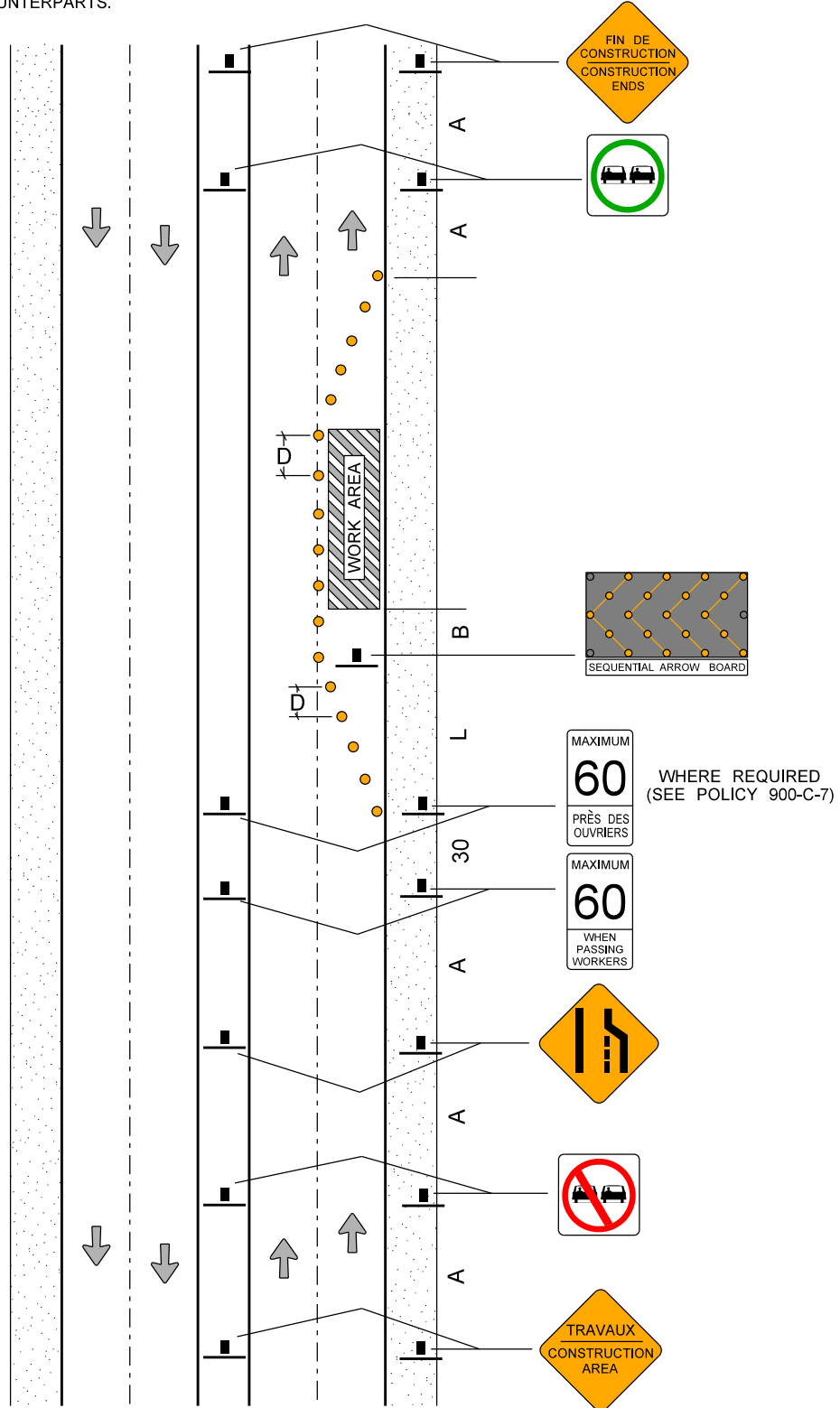

S(km/h)	A(m)	L(m)	B(m)	D(m)
50	50	60	35	15
60	50	90	45	15
70	75	120	50	15
80	100	175	55	15
90	100	200	65	20
100	150	250	70	20

WHERE:
S = SPEED LIMIT
A = SPACING BETWEEN SIGNS
L = LENGTH OF TAPER
B = LENGTH OF LONGITUDINAL BUFFER SPACE
D = SPACING BETWEEN DELINEATION DEVICES

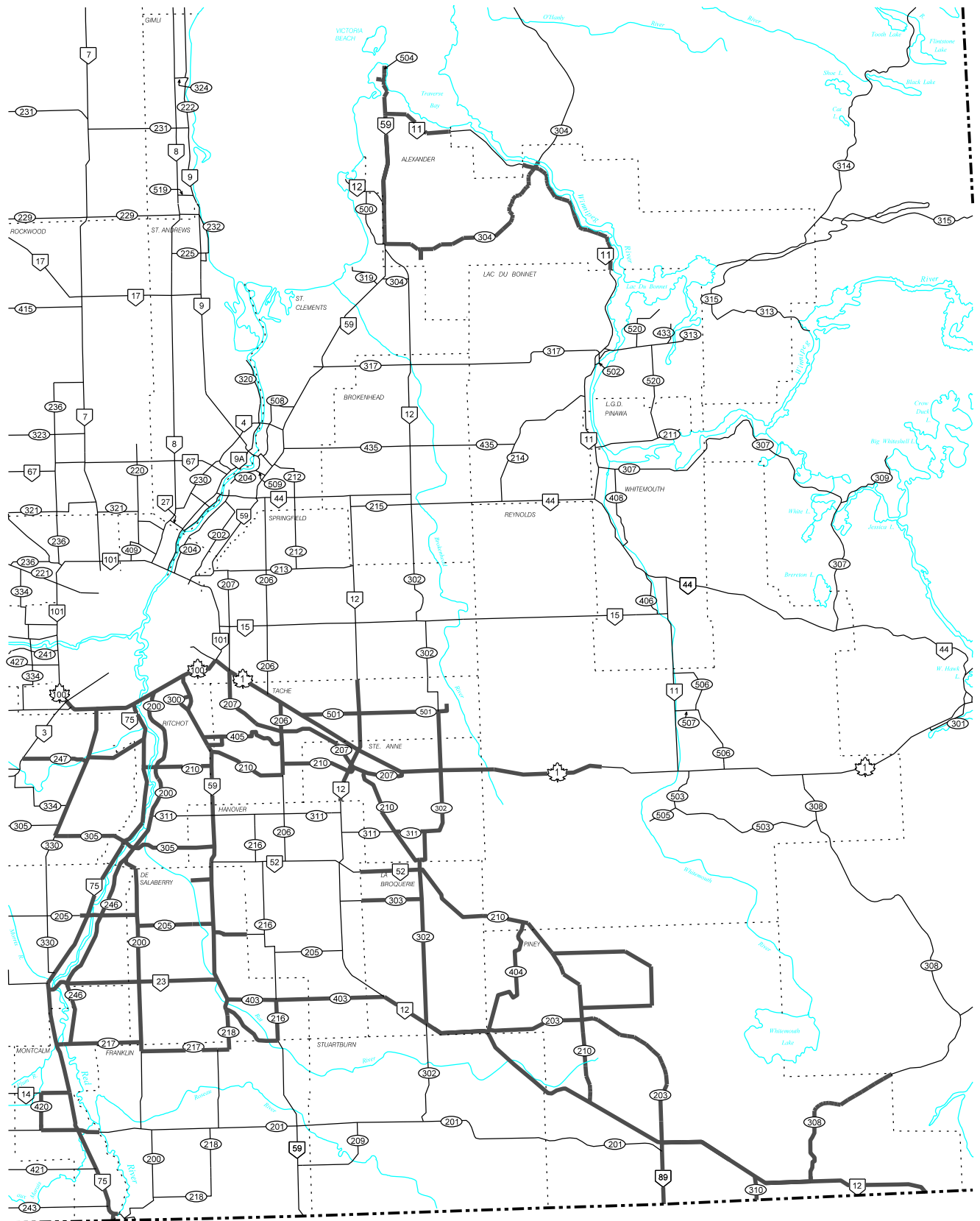

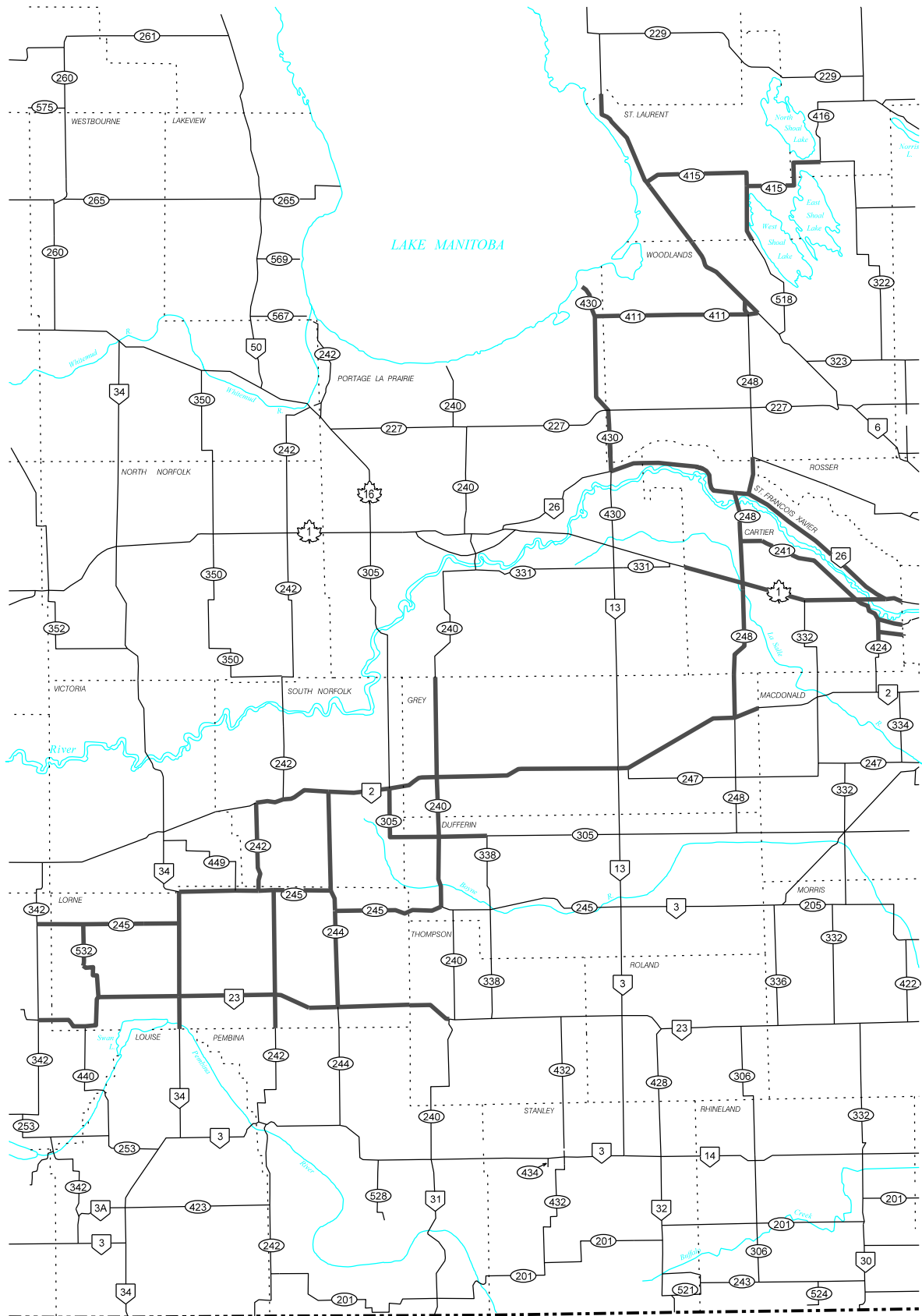

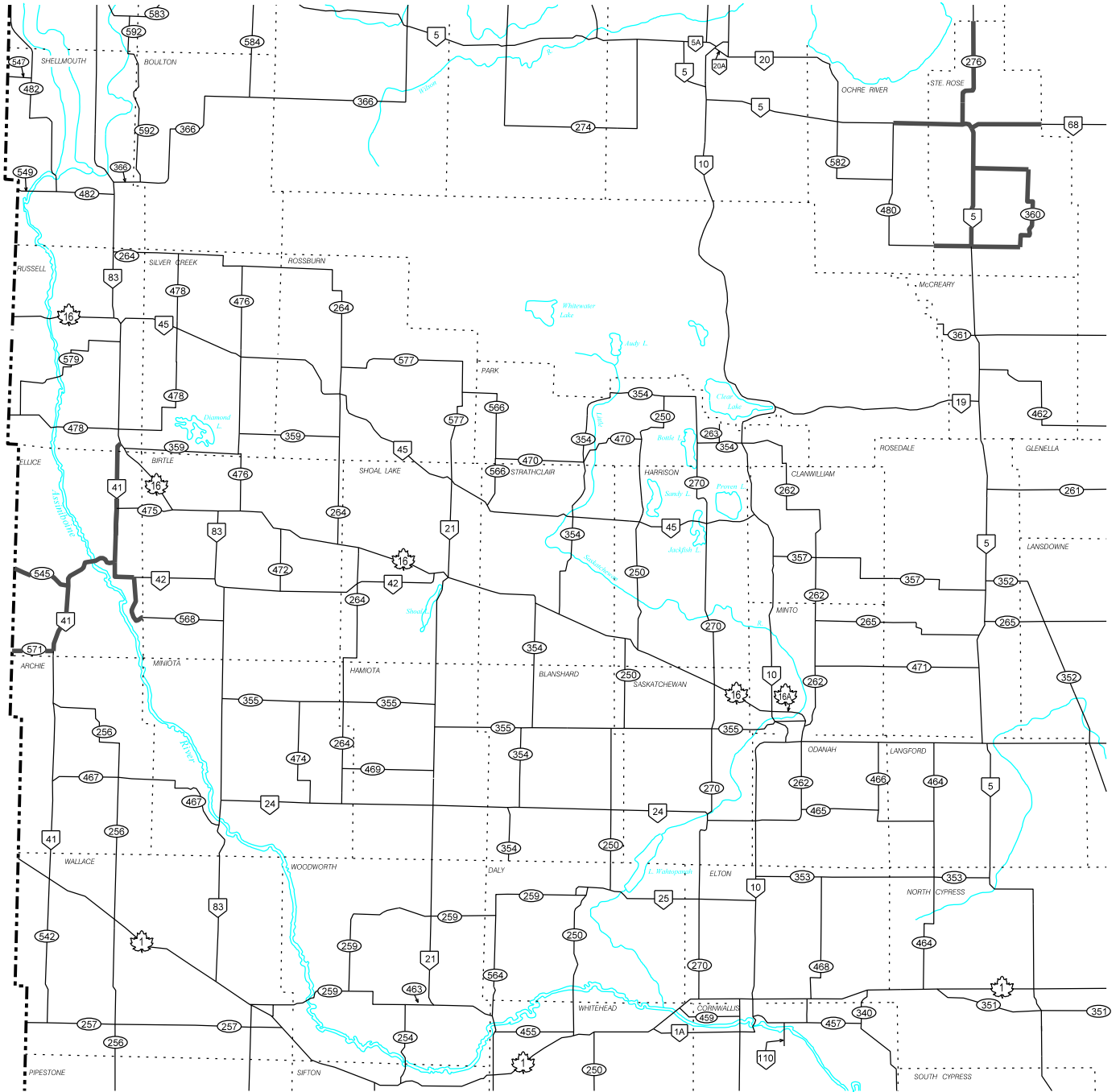

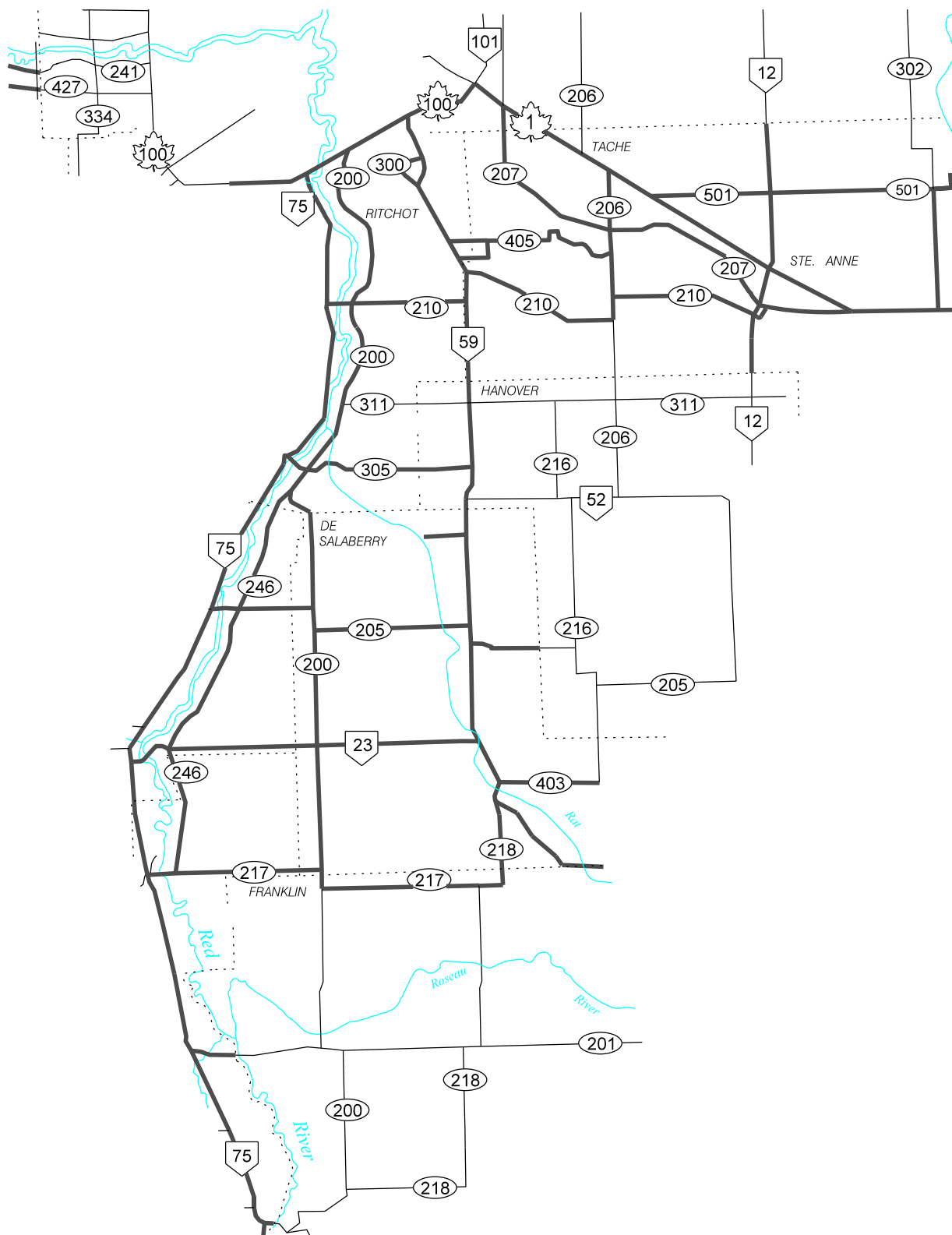

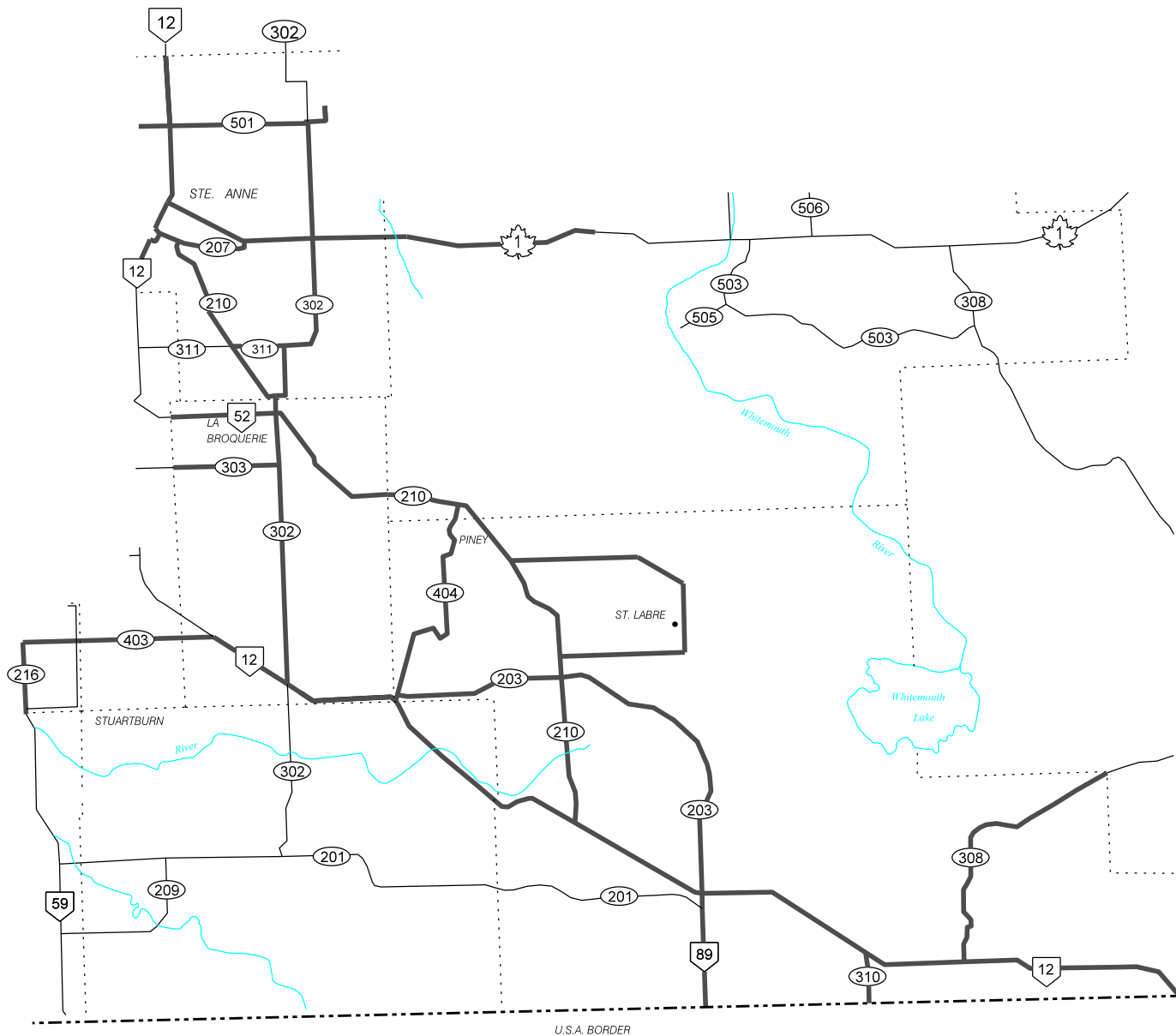

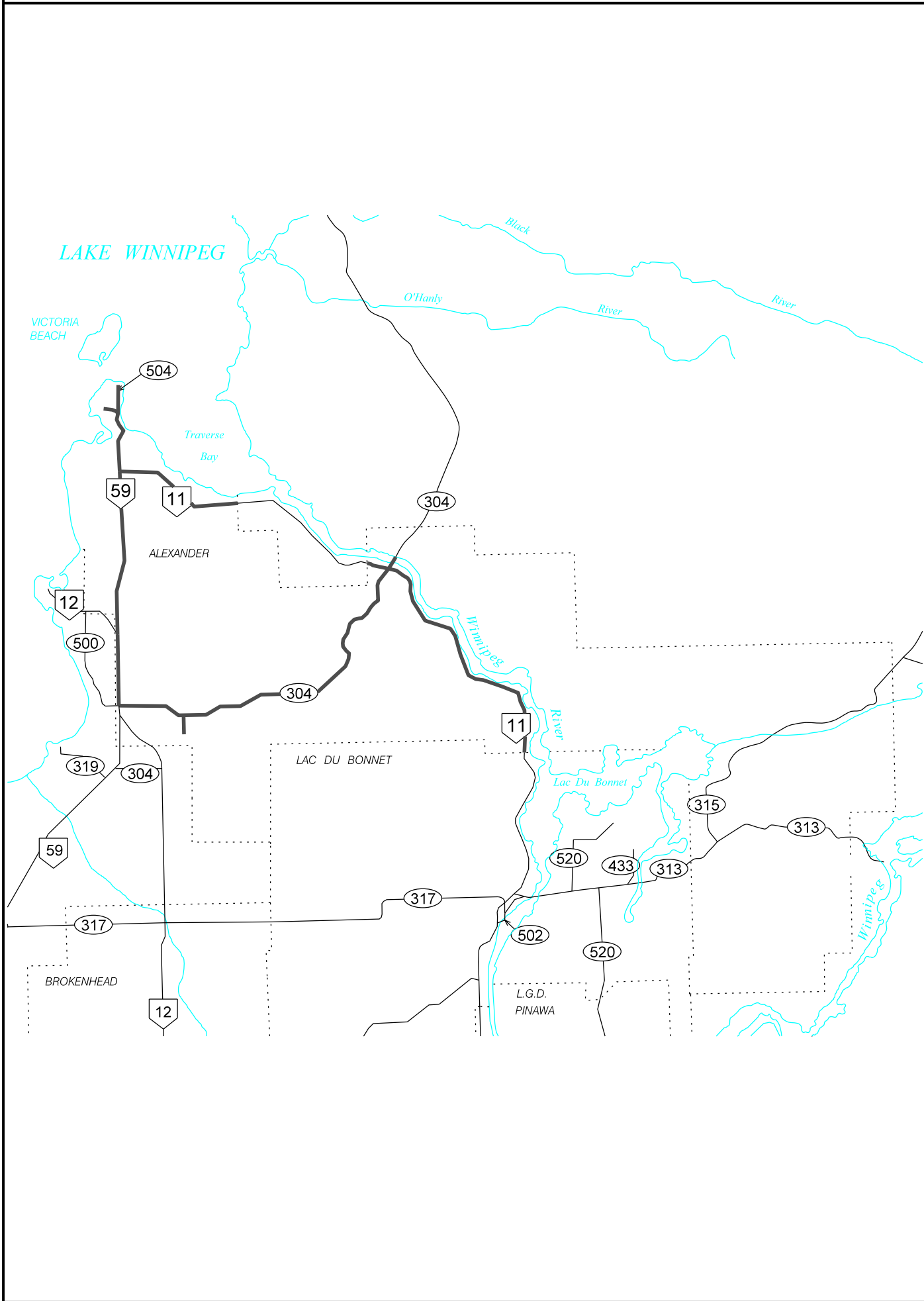

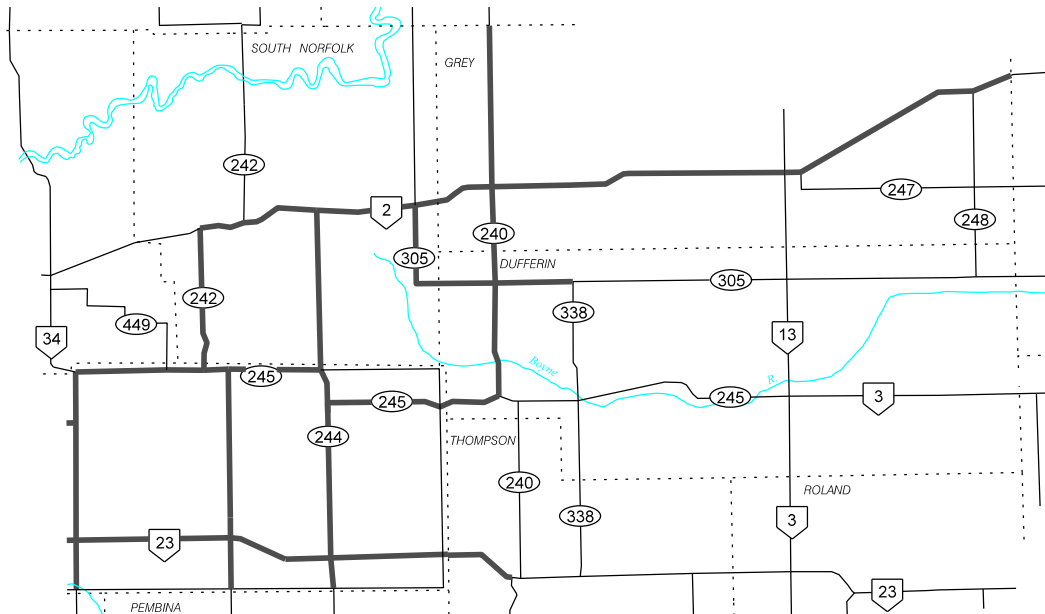
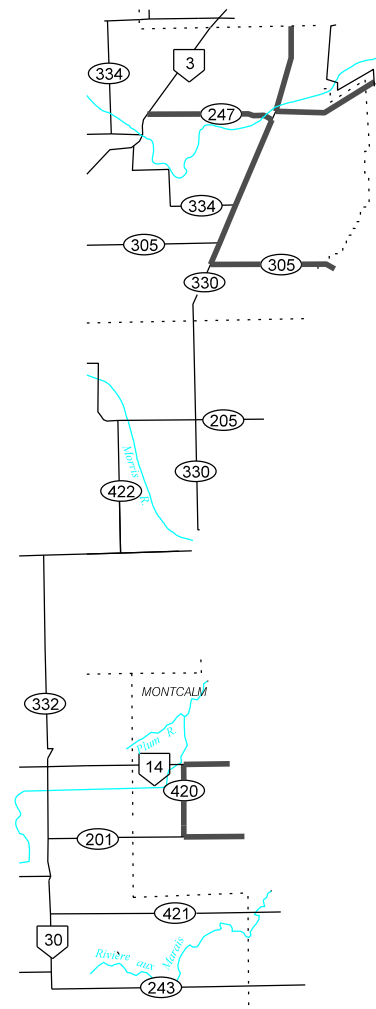
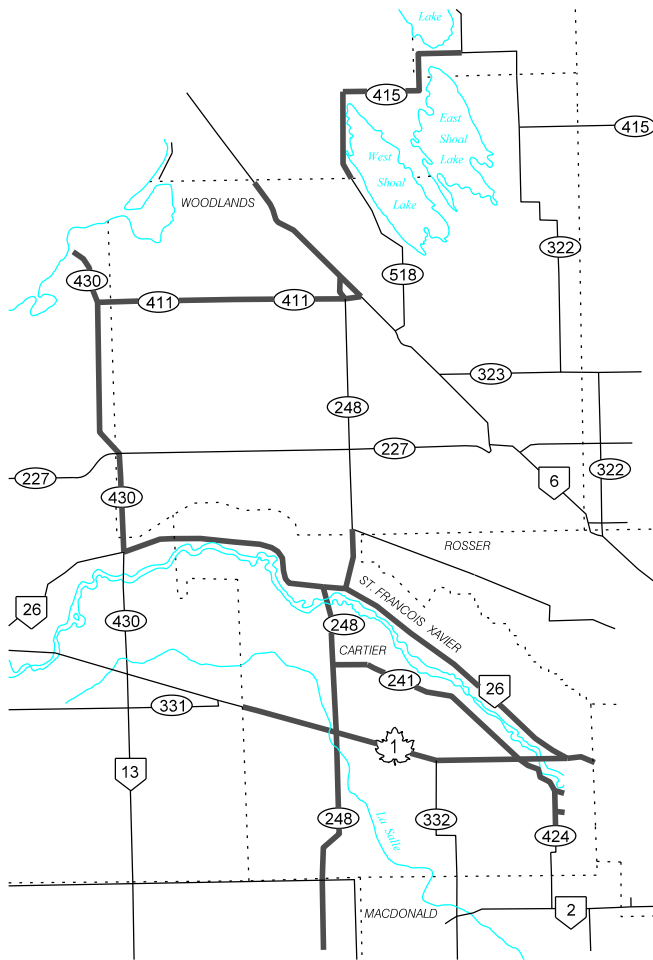

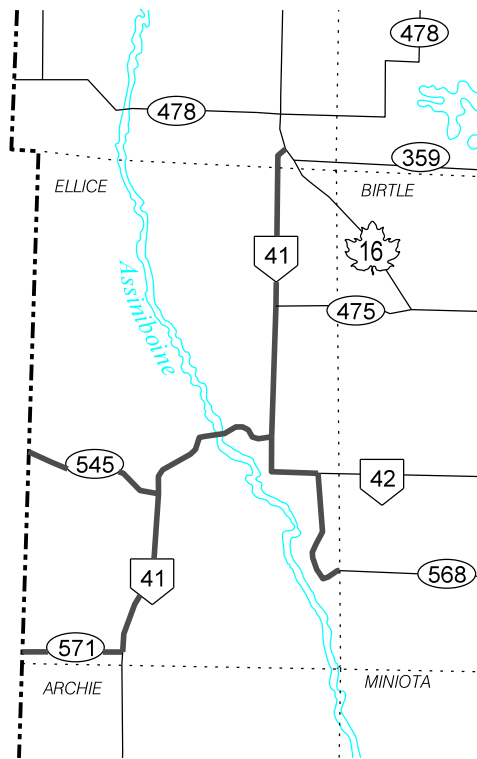
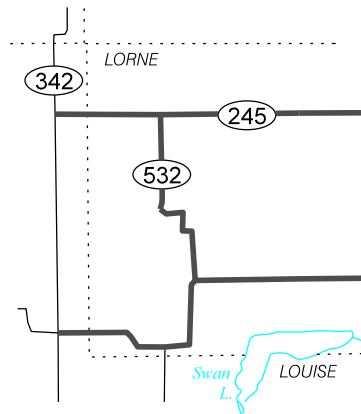

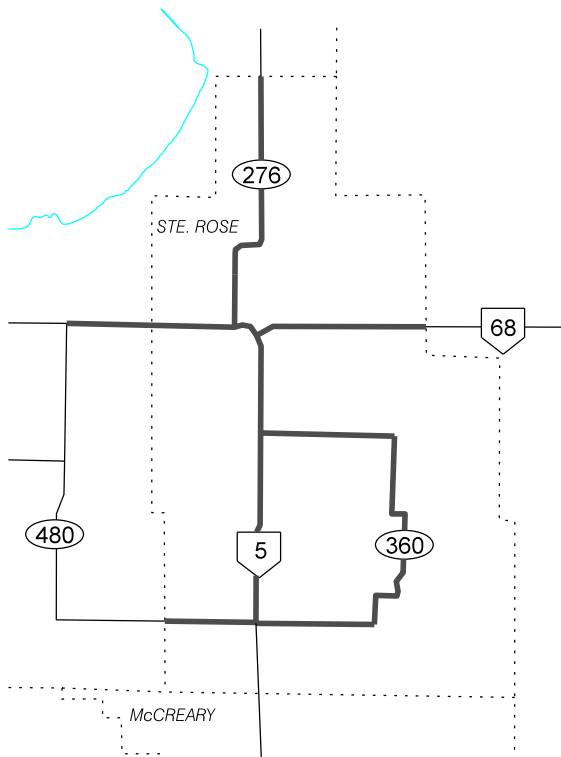
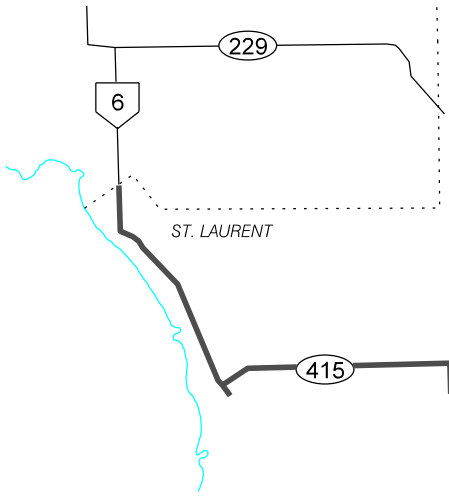

Traffic Control Device: **Work Zone**

Date of Revision: **March 15, 2002**

Division:

Subject: **Requirements**

Page **1 of 3**

Purpose

A traffic control device is any device placed upon, over or adjacent to a roadway that is intended to regulate, warn or guide motorists and provide for the orderly movement of traffic. In construction and maintenance work zones, traffic control devices are used to ensure safe passage for the travelling public through or around the work area, and to safeguard the personnel involved in the work. Traffic control devices include signs, delineators, channelizers, barricades, pavement markings, lighting devices, flagperson/flagging equipment, and any other device placed upon a public roadway which warns motorists of dangerous conditions or provide for the safe movement of traffic.

Policy

Only those devices that are approved by the Manitoba Infrastructure and Transportation may be used on provincial highway projects. Traffic Engineering Branch must be contacted before any non-standard traffic control device is placed on the road.

Standard

Basic Requirements

To be effective, a traffic control device must meet five basic requirements:

- fulfill a need
- command attention
- convey a clear, simple message
- command the respect of motorists
- give adequate time for proper response

Five basic considerations are employed to ensure that these requirements are met:

- device design
- uniformity
- placement
- application
- maintenance

RECOMMENDED: "ORIGINAL SIGNED BY" _____
Director, Traffic Engineering

APPROVED: "ORIGINAL SIGNED BY" _____
Executive Director
Highway Engineering

Device Design

The following design elements must be considered when selecting traffic control devices:

- size
- shape
- colour(s)
- contrast
- composition
- reflectivity
- message simplicity
- message legibility

These design elements combine in various ways to influence how effectively a device meets the basic traffic control device requirements.

Device Uniformity

Traffic control device uniformity aids in recognition, interpretation and message comprehension, simplifying the task of the motorist. Uniformity applies not only to the design of traffic control devices but also to how the devices are used. A standard device used inappropriately is as objectionable as a non-standard device. Misuse can result in disrespect for the standard device at locations where it is needed. Uniformity also reduces the costs associated with device manufacture, installation, maintenance, and administration. Minor modifications of a specified device may be allowed due to necessity. However, the essential device characteristics must be maintained. The *Uniform Traffic Control Devices for Canada* (UTCD) manual should be used as a resource document to help ensure uniformity.

Device Placement

Traffic control devices should be placed within the cone of vision of the motorist (approximately 10 degrees from the roadway alignment) so that they command attention. Devices must be located with respect to the point, object or situation to which they apply to aid in conveying the proper meaning. Device location, combined with legibility, must allow for an adequate response time from motorists travelling at normal speeds. Traffic control devices must be spaced far enough apart to allow a motorist to respond correctly to each in turn, while avoiding rapid or sudden reactions which could cause loss of control.

Device Application

Device application should ensure that sufficient and applicable devices and related equipment are installed to meet the traffic requirements at any given location. The motorist must be guided into and through the work zone by a series of signs and devices which give the driver an opportunity to adjust to upcoming conditions. Devices must be installed only if they are necessary; unnecessary traffic control devices contribute to work zone "clutter" and detract from those that are needed.

Devices must be applied in a uniform and consistent manner. This uniformity allows motorists to anticipate traffic control situations similar to those previously experienced, and helps to ensure they respond properly.

Due to decreased visibility, motorist safety is compromised more at night than during the day. Therefore, traffic control in work zones, particularly detours with speed drops greater than 30 km/h, must be assessed at night as well as during the day to determine the adequacy of the traffic control devices.

The following factors influence how well a system of traffic control devices performs at night:

- device condition
- size
- reflectivity
- enhancements
- longitudinal position
- lateral position
- the "total effect"

The most important factor is the relationship between traffic control devices and other construction and/or permanent devices, i.e., the "total effect". A work zone where the traffic control is relatively straightforward during the day may become quite confusing to motorists at night. The clutter of reflectorized signs, delineators, and barricades can make it difficult to travel through a work zone safely. If work zone traffic control must be left in place overnight, any permanent or temporary devices that are not needed and may tend to confuse motorists must be covered or removed. Special emphasis involving positive guidance, illumination and/or sequential flashers may be required at transitions from four-lane divided highways to two-lane roadways.

Device Maintenance

Maintenance of traffic control devices can be divided into two types - Physical and Functional:

Physical Maintenance - All traffic control devices used in construction and maintenance work zones must be maintained to high standards to ensure that visibility and legibility are retained both day and night. Clean, legible, properly installed devices in good working condition command the respect of motorists. Traffic control devices must be monitored to ensure their satisfactory condition, and if necessary, must be immediately repaired or replaced.

If traffic control devices are left in place overnight, inspections must be performed periodically to ensure that nighttime reflective levels are adequate. Traffic control devices with inadequate reflective levels must be immediately replaced.

Functional Maintenance - Functional Maintenance involves adjusting traffic control devices to changes in work zone conditions. When operations cease due to darkness or a change in the sequence of the work, only those traffic control devices necessary to protect motorists must remain in place. Devices which are no longer applicable must be removed or replaced.

Functional maintenance includes ensuring that the system of traffic control devices operates as specified in the Traffic Management Plans. This includes making sure that only those traffic control devices approved by the Department are used and that no obsolete, inappropriate or otherwise objectionable devices are installed.

Traffic Control Device: **Work Zone**

Date of Revision: **September 22, 2006**

Division:

Subject: **Flagpersons**

Page **1 of 2**

Purpose

The flagperson ("flagman") is one of the most effective and flexible "devices" available to control traffic in work zones. For a variety of reasons the flagperson has one of the most difficult jobs to perform.

In Section 77(10) of The Highway Traffic Act, a **flagperson** is defined as:

"a person employed by a traffic authority, or a contractor doing work on behalf of a traffic authority, for the purpose of directing the movement of traffic on any portion of a highway under construction, or where repair work or other work is being carried on".

Under Section 77(11) of The Highway Traffic Act

"every driver of a vehicle shall obey and observe the directions given by a flagman".

The Highway Traffic Act gives the flagperson the authority to control traffic by signalling for a motorist to stop, to reduce speed, to proceed as directed, or by advising how to pass safely through or around a work area.

Standard

To optimize this traffic control function the following guidelines/principles, in addition to those contained in the flagpersons handbook, should be utilized when controlling traffic through a work area by the use of flagpersons.

- All flagpersons must be trained, whether directly employed by the Manitoba Infrastructure and Transportation or by a contractor. When flagpersons are employees of a contractor, it is the Contractor's responsibility, as part of core certification, to train and perform the duties of a flagperson in a proper manner.
- A symbolic Flagman Ahead sign (TC-21) should always be used in advance of the flagperson. The Flagman Ahead sign must be visible to the flagperson at all times and should not be more than 200 m from the flagperson at any time. The "stop/slow" sign paddle will normally be used by all flagpersons.

RECOMMENDED: "ORIGINAL SIGNED BY" _____
Director, Traffic Engineering

APPROVED: "ORIGINAL SIGNED BY" _____
Executive Director
Highway Engineering

- Where flaggers are required at a mobile work area or where lane control in pilot vehicles are used, these flaggers must be supplemented by flaggers at the start of the work zone, within 200 metres of the FLAGGER AHEAD sign. Additional signs are not typically needed but may be used.
- In general, flagpersons should be used when it is desirable or necessary to give some message to the motorist respecting:
 - road or traffic conditions ahead
 - the correct path to follow
 - the existence of potential conflicts between the road user and workers or equipment
 - limited approach sight distance to the work ahead

A flagperson present for any of the above reasons can also be effective for the general slowing of traffic in the work area, when required. However, the length of the downstream residual slowing effect is minimal.

- Notwithstanding the criteria above, some degree of discretion must be used to reflect varying traffic volumes and conditions. Thus a particular set of conditions may warrant one or more flagpersons on high volume roads; the same conditions on a low volume road may not require any flagpersons, at least during portions of the day.
- Overuse of flagpersons causes disrespect by the public, for the function. When not needed as a flagperson, that person should be taken out of view of the motorist, and possibly given some other duty.
- The wearing of proper flagperson regalia, as outlined in the Flagperson Training Workbook, must be strictly enforced, for reasons of safety, uniformity and communication to the motorists.
- A flagperson is not normally required where:
 - there is no requirement to slow or stop traffic
 - a sequential flasher is in operation
 - the MAXIMUM 60 WHEN PASSING WORKERS sign (MR-96) is in place
- The flagperson must be kept apprised of the changing conditions in the work area so he/she can effectively communicate with the motorist.

Note: Refer to the Department's *Flagging Traffic* pamphlet, or the *Flagperson Training Workbook* for information about employer and employee responsibilities, equipment, clothing, flagging practices, and procedures. Contact Traffic Engineering Branch or the Regional Safety Training Facilitator for these Department publications.

Traffic Control Device: **Work Zone**

Date of Revision: **March 15, 2002**

Division:

Subject: **Signs**

Page **1 of 1**

Purpose

Traffic signs are used to inform and guide motorists through construction and maintenance work zones. They can convey both general and specific messages through the use of words or symbols.

Policy

Only those signs approved for use in Manitoba may be installed in a construction and maintenance zone. Any existing or temporary signs that become redundant or contradictory because of work zone activities must be promptly removed.

Standard

Application and use of traffic signs are governed by the Highway Traffic Act, and its supporting regulations, and by Manitoba Infrastructure and Transportation policies (including Traffic Engineering Branch Policies 100-A-1 to 100-H-3). Refer to these sources for specific applications on the use of these signs.

In general only those signs listed and described herein may be used in work zones.

RECOMMENDED: "ORIGINAL SIGNED BY"
Director, Traffic Engineering

APPROVED: "ORIGINAL SIGNED BY"
Executive Director
Highway Engineering

Traffic Control Device: **Work Zone**

Date of Revision: **March 15, 2002**

Division:

Subject: **Sign Placement**

Page **1 of 2**

Purpose

Sign placement is critical for motorist recognition and legibility. Sign placement standardization cannot always be attained in practice because signs, in all cases, must be placed in the most advantageous position.

Policy

All traffic signs should be located in the most advantageous position for the motorist.

Standard

Notwithstanding that sign positions are dependent on many extraneous factors the following guidelines should be used when installing signs in work zones:

- Temporary signs in construction and maintenance work zones should normally be positioned on the right-hand side of the road. When two or more adjacent lanes accommodate traffic travelling in the same direction, and sufficient space is available on the median, signs must be positioned on both sides of the roadway.
- Signs must be positioned within the cone of vision of the motorist in a location where they will convey their message most effectively.
- On uncurbed roadways all signs, except those mounted on portable sign stands, must be positioned clear of the highway shoulder line by at least 1.0 m.
- On curbed roadways signs must be positioned clear of the curb edge by a minimum of 600 mm in rural areas and 400 mm in urban areas.
- All installations must be mounted so that the sign face is oriented towards oncoming traffic and must be constructed to yield upon impact, minimizing the hazard to motorists.
- For long duration construction and maintenance work, signs should be mounted on minimum 100 x 100 mm wood posts.

RECOMMENDED: "ORIGINAL SIGNED BY" _____
Director, Traffic Engineering

APPROVED: "ORIGINAL SIGNED BY" _____
Executive Director
Highway Engineering

- Signs mounted on portable sign stands should be a minimum 600 mm above the surface of the road.
- Signs mounted on more permanent structures should be mounted at minimum 1.5 m above the surface of the road.

Traffic Control Device: **Work Zone**

Date of Revision: **March 15, 2002**

Division:

Subject: **Portable Signs**

Page **1 of 1**

Purpose

Signs mounted on approved portable sign stands are suitable for short term projects, maintenance operations or to advise of temporary roadway conditions.

Policy

Portable signs must be installed prior to work commencing and should be moved and maintained as the work progresses. If a portable sign is used to identify a hazardous condition, the sign should remain in place until the hazard has been eliminated.

Standard

Sign stands should be placed on the shoulder, clear of normal vehicular traffic. They should stand vertically facing motorists and must be pinned, ballasted or so designed that wind gusts will not topple the sign. Portable signs should be offset from the adjacent travelled lane as much as the available shoulder width allows. Portable signs should be erected to a minimum height of 600 mm above the surface of the adjacent travelled lane. For enhanced visibility, fluorescent blaze orange flags may be attached to the sign stand.

The use of steel plates, tire rims and other non-approved devices as sign stand bases is strictly prohibited.

When a ballast is needed to keep the sign stands in place, that ballast must consist of loose free flowing granular material contained in a soft, durable bag (sand bag). Rocks, bricks, or any other solid object, must never be used as these can present a hazard to motorists.

The following sign stands are approved by Manitoba Infrastructure and Transportation:

- Flexmast Model PCC3648
- Quadra Flex Model QFVR
- Windmaster Model 4818
- Stellmaster Model 505M

RECOMMENDED: "ORIGINAL SIGNED BY"
Director, Traffic Engineering

APPROVED: "ORIGINAL SIGNED BY"
Executive Director
Highway Engineering

Traffic Control Device: **Work Zone**

Date of Revision: **March 15, 2002**

Division:

Subject: **Optional Sign Mounting Locations**

Page **1** of **1**

Purpose

Occasionally it is desirable to locate signs in other than typical locations.

Policy

Subject to the approval of the Director of Traffic Engineering sign installations may be located in non-typical locations.

Standard

For specific operations, certain signs may be effectively mounted on the rear of a vehicle stationed upstream of the work or moving along with the work. This may be the working vehicle itself, or a trailing/buffer vehicle provided expressly for this purpose.

Signs should not normally be mounted on barricades. This does not include the CONSTRUCTION ENDS sign (TC-1) which is mounted on gateway assemblies and notes the outer limits of a construction area.

RECOMMENDED: "ORIGINAL SIGNED BY" _____
Director, Traffic Engineering

APPROVED: "ORIGINAL SIGNED BY" _____
Executive Director
Highway Engineering

Traffic Control Device: **Work Zone**

Date of Revision: **March 15, 2002**

Division:

Subject: **Sign Spacing**

Page **1 of 1**

Purpose

The spacing of signs in construction and maintenance work zones must allow a motorist time to understand and respond to a given sign before coming upon the next. In work zones, sign spacing is largely dependent on the posted speed limit.

Policy

On roadways with a posted speed of 80 km/h or less, signs should normally be spaced at least 100 m apart. On roads with speed limits greater than 80 km/h, and on all four-lane divided highways, the sign spacing should normally be at least 150 m. The sign spacing may be adjusted if required by sight distance limitations, work zone conditions, or space constraints. In any case, signs should not be spaced less than 50 m apart.

RECOMMENDED: "ORIGINAL SIGNED BY"
Director, Traffic Engineering

APPROVED: "ORIGINAL SIGNED BY"
Executive Director
Highway Engineering

Traffic Control Device: **Work Zone**

Date of Revision: **March 15, 2002**

Division:

Subject: **Passing Restrictions**

Page **1 of 1**

Purpose

Pavement markings are an integral part of any traffic control system. In some cases they are used to supplement the operation of other traffic control devices such as signs or signals. However, in many instances they stand alone and must obtain results solely on their own merits. This is the case with those pavement markings that advise motorists that sections of roadway have limited sight distance, and that passing is prohibited.

As a consequence **it is imperative that passing restrictions due to limited sight distance be maintained at all times**. In construction and maintenance areas where pavement markings are obliterated, the only effective way of maintaining passing restrictions is through the use of appropriate signs.

Policy

In construction and maintenance areas when pavement markings are obliterated, the beginning and end of all passing restrictions which mark locations of limited sight distance should be identified with signs. These signs should be installed prior to the start of any activity that obliterates the existing pavement markings.

The beginning of passing restrictions should be identified by a PASSING PROHIBITED sign (RB-31), and the end of these passing restrictions identified by a PASSING PERMITTED sign (RB-32). When lengthy passing restrictions are obliterated, additional PASSING PROHIBITED signs should be used at minimum intervals of 1 km to provide ongoing positive warning of the continuing passing restrictions.

PASSING PROHIBITED and PASSING PERMITTED signs should be removed once the pavement markings have been reinstalled.

RECOMMENDED: “ORIGINAL SIGNED BY”
Director, Traffic Engineering

APPROVED: “ORIGINAL SIGNED BY”
Executive Director
Highway Engineering

Traffic Control Device: **Work Zone**
Division:
Subject: **Barricades**

Date of Revision: September 29, 2008

Purpose

A barricade is used to physically separate traffic from unusual situations created by construction and maintenance work activities or from objects on or near the travelled way.

Policy

A barricade or system of barricades should be used where a collision with an object would be more hazardous than a collision with a barricade. If barricades are found to be more hazardous, traffic cones, plastic drums or other traffic control devices should be used instead. Barricades can also be used to block off a portion or all of a lane or roadway where road closures become a necessity. Barricades must not be used to channelize traffic.

Standard

A barricade may be one of three types: Class A, Class B, or Class C. Each class of barricade consists of one to three barricade boards or rails attached to a frame constructed of wood or other approved lightweight material:

Class A barricade - Two 400 x 1800 mm barricade boards (H-317), spaced 200 mm apart, with a total height of 1500 mm.

Class B barricade - Three 200 x 1800 mm rails (H-316R/L), spaced 150 mm apart, with a total height of 1500 mm. A H-316L board is installed at the top and bottom of the barricade, and a H-316R is mounted in the middle.

Class C barricade - One 200 x 1800 mm barricade board (H-316R/L), with a height of 1000 mm.

Markings for barricade boards must be alternate 150 mm wide orange and black diagonal stripes, reflectorized to a level meeting or exceeding the requirements for Type IV (micro-prismatic) sheeting as described in the ASTM standard D 4956. The predominate colour of other barricade components should be either orange or white. Owner identification must not be imprinted on the reflectorized face of any board or rail, but may be imprinted on the supports or the rear face of the boards.

RECOMMENDED: "ORIGINAL SIGNED BY"

Director, Traffic Engineering

APPROVED: "ORIGINAL SIGNED BY"

Executive Director
Highway Engineering

Barricade Applications

The three barricade classes are employed as follows:

- Class A barricades are used to effect a **lane closure**. They are placed at the end of a transition taper and show the direction of the detour.
- Class B barricades are generally used to effect a **complete roadway closure**.
- Class C barricades may be placed at regular intervals within a work zone in order to **maintain a lane closure**.

Barricades may be used singly or in groups to mark hazards. They must be kept in good repair and cleaned or re-sheeted as necessary to maintain their appearance. A BARRICADE AHEAD sign (MC-4) should be installed to give motorists advance warning of a barricade.

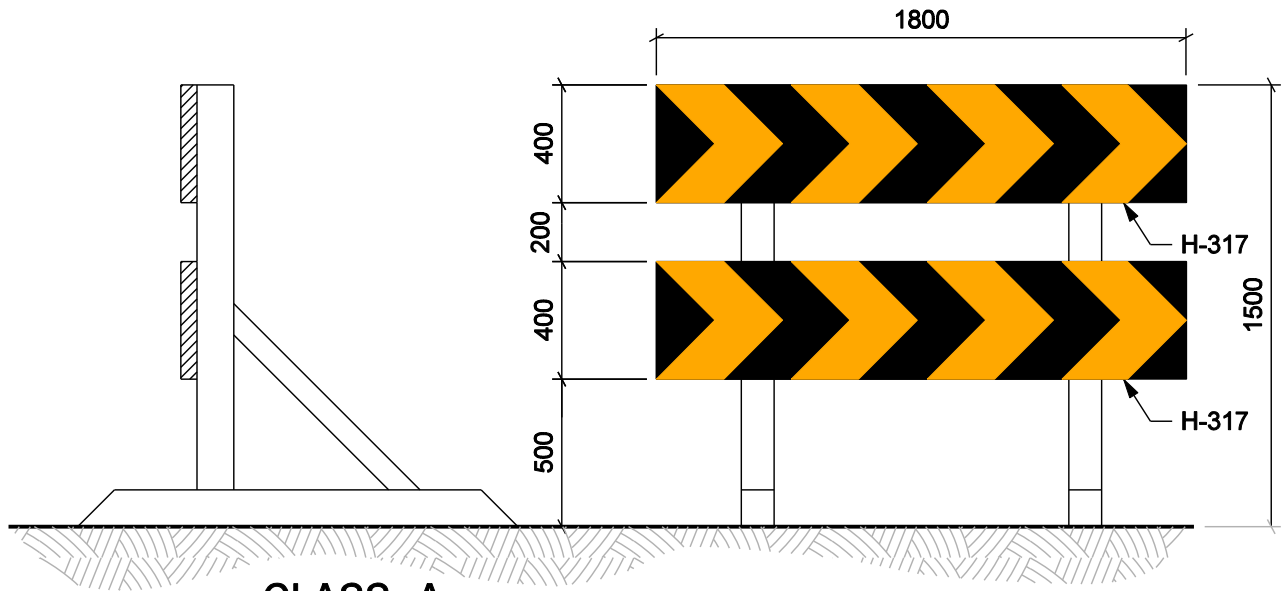

CLASS A

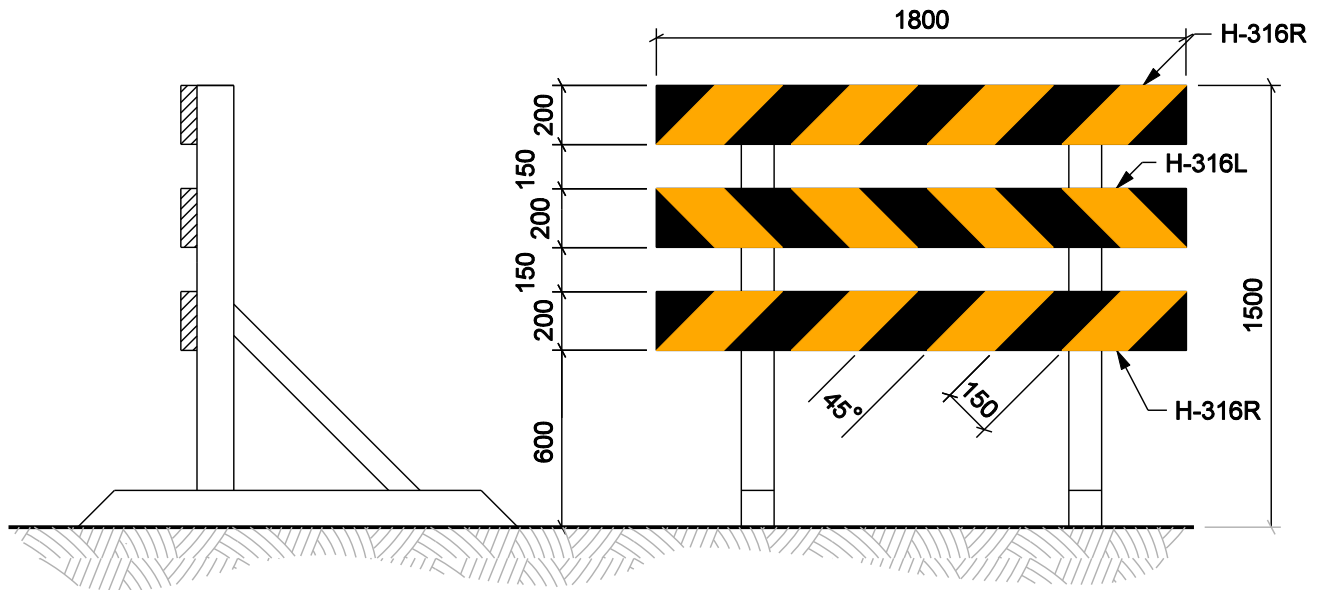

CLASS B

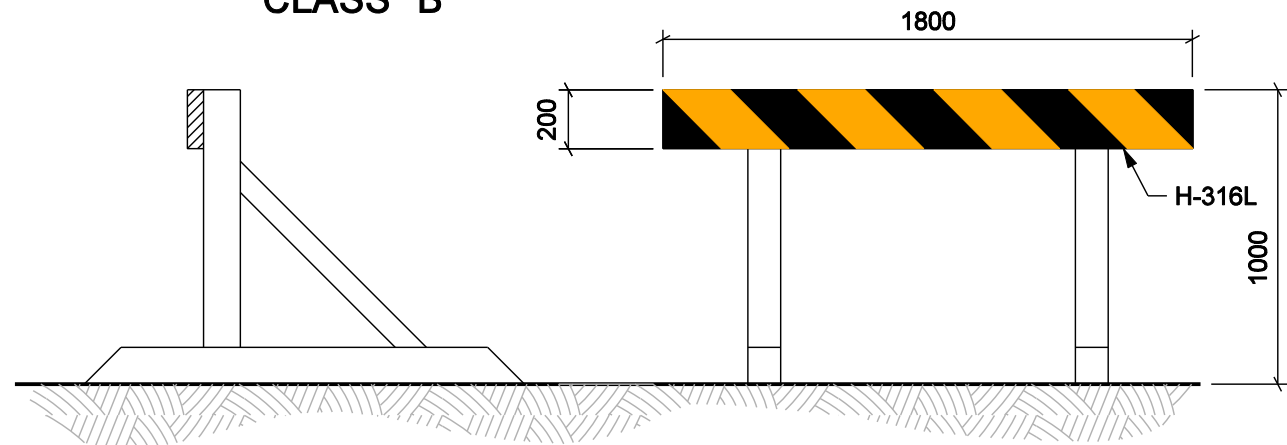

CLASS C

NOTES:

- 1. BARRICADE BOARDS SHALL BE ORANGE AND BLACK.
- 2. SUPPORT FRAMES SHALL BE WOODEN AND ANCHORED BY WEIGHTS OR PINS.
- 3. H-316L IS USED FOR LEFT LANE CLOSURE.
- 4. H-316R IS USED FOR RIGHT LANE CLOSURE.

Traffic Control Device: **Work Zone**

Date of Revision: February 10, 2009

Division:

Subject: **Gateway Assembly**

Page **1 of 7**

Purpose

Gateway assemblies are special barricades used to denote the outer limits of a construction area.

Policy

Gateway assemblies must be installed at the limits of a long term construction project as indicated in the Traffic Management Plan (TMP) for that project.

Standard

Gateway assemblies consist of three 200 x 3600 mm double-sided barricade boards (H-318R/L), mounted as shown on page 2. Each board is reflectorized to a level meeting or exceeding the requirements for Type IV (micro-prismatic) sheeting as described in the ASTM standard D 4956 and has 150 mm wide orange and black diagonal stripes on one side and 150 mm wide white and black diagonal stripes on the other. The barricade boards (H-318R) are installed on gateway assemblies placed to the right of traffic and the barricade boards (H-318L) are installed on those placed to the left. Each gateway assembly is equipped with either a CONSTRUCTION AREA sign (MC-1), with a sign tab (WA-28S (orange)) if necessary, or a CONSTRUCTION ENDS sign (TC-4).

A gateway assembly is installed at the break point of the shoulder on each side of the roadway. Gateways are oriented so that the CONSTRUCTION AREA sign and the orange and black side of the barricade boards (H-318R/L) are visible to oncoming traffic. Traffic leaving a construction area shall see a CONSTRUCTION ENDS sign and the white and black side of H-318R/L rails.

RECOMMENDED: "ORIGINAL SIGNED BY"

Director, Traffic Engineering

APPROVED: "ORIGINAL SIGNED BY"

Executive Director
Highway Engineering

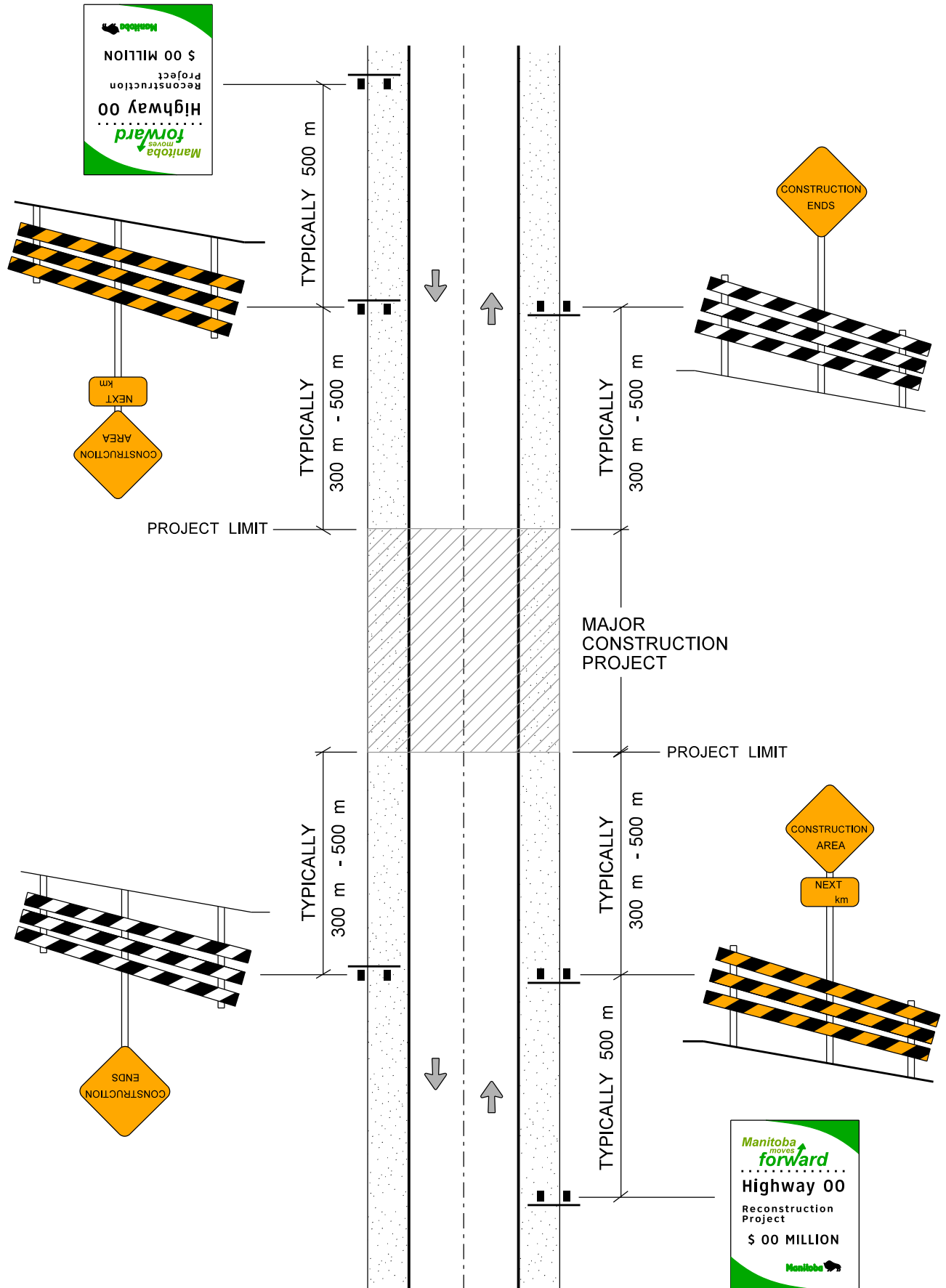

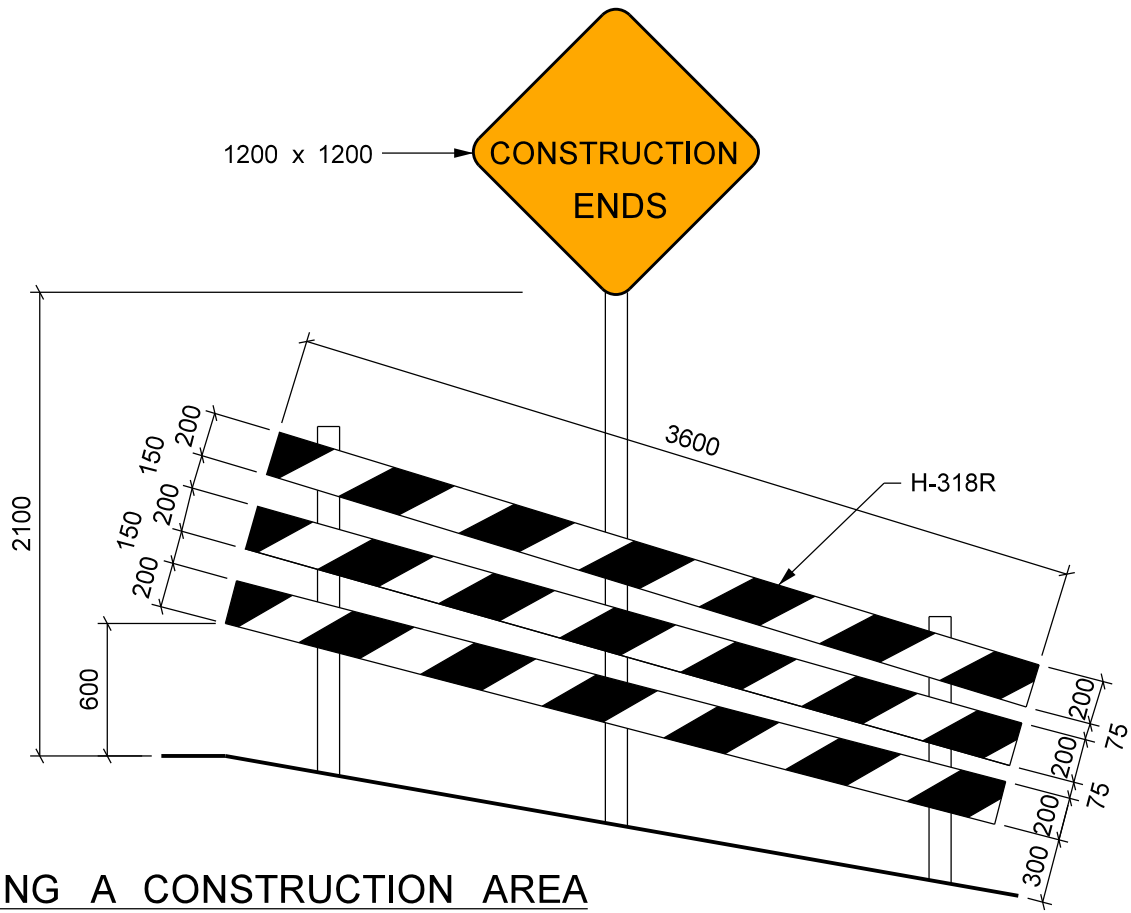

LEAVING A CONSTRUCTION AREA
BLACK ON WHITE

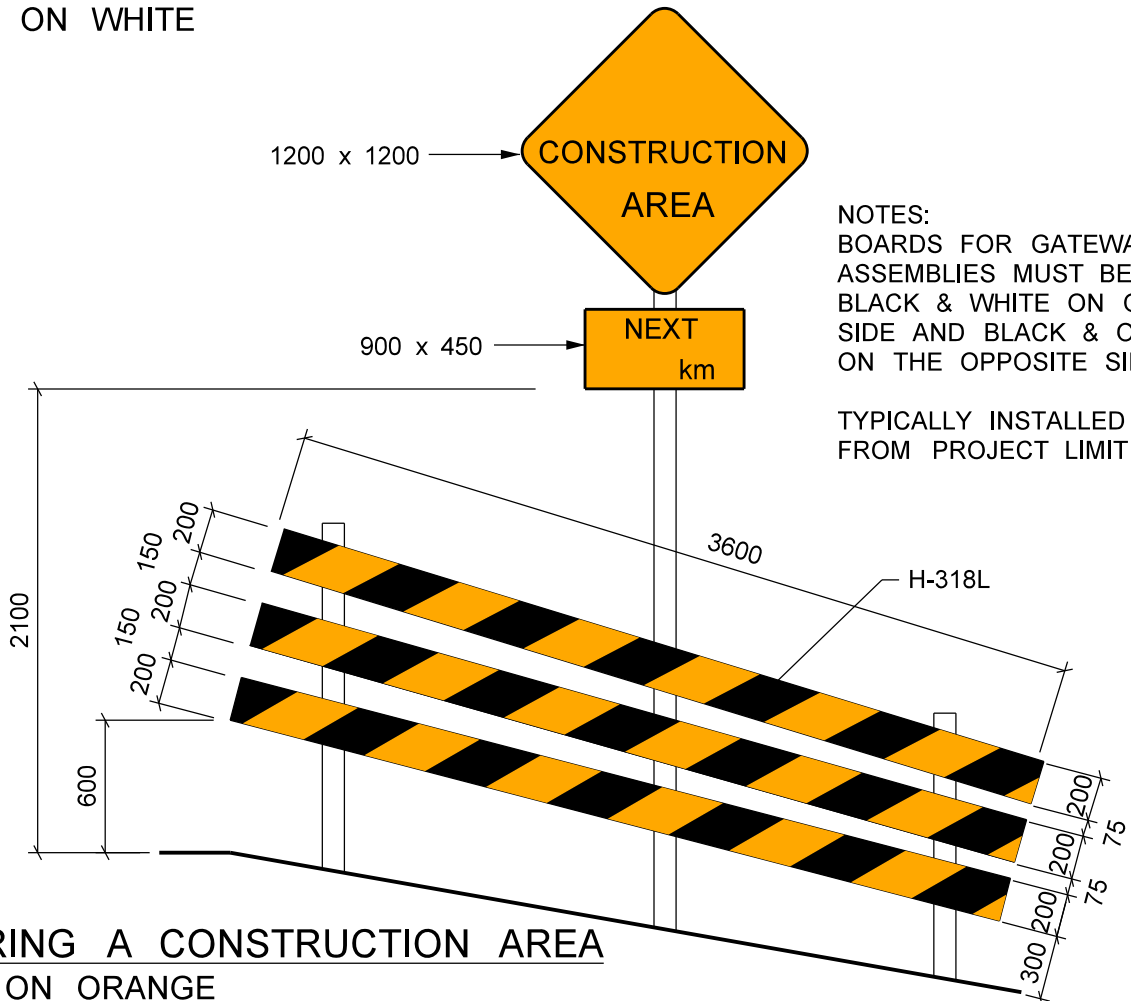

NOTES:
BOARDS FOR GATEWAY ASSEMBLIES MUST BE BLACK & WHITE ON ONE SIDE AND BLACK & ORANGE ON THE OPPOSITE SIDE

TYPICALLY INSTALLED 500 m FROM PROJECT LIMIT

ENTERING A CONSTRUCTION AREA
BLACK ON ORANGE

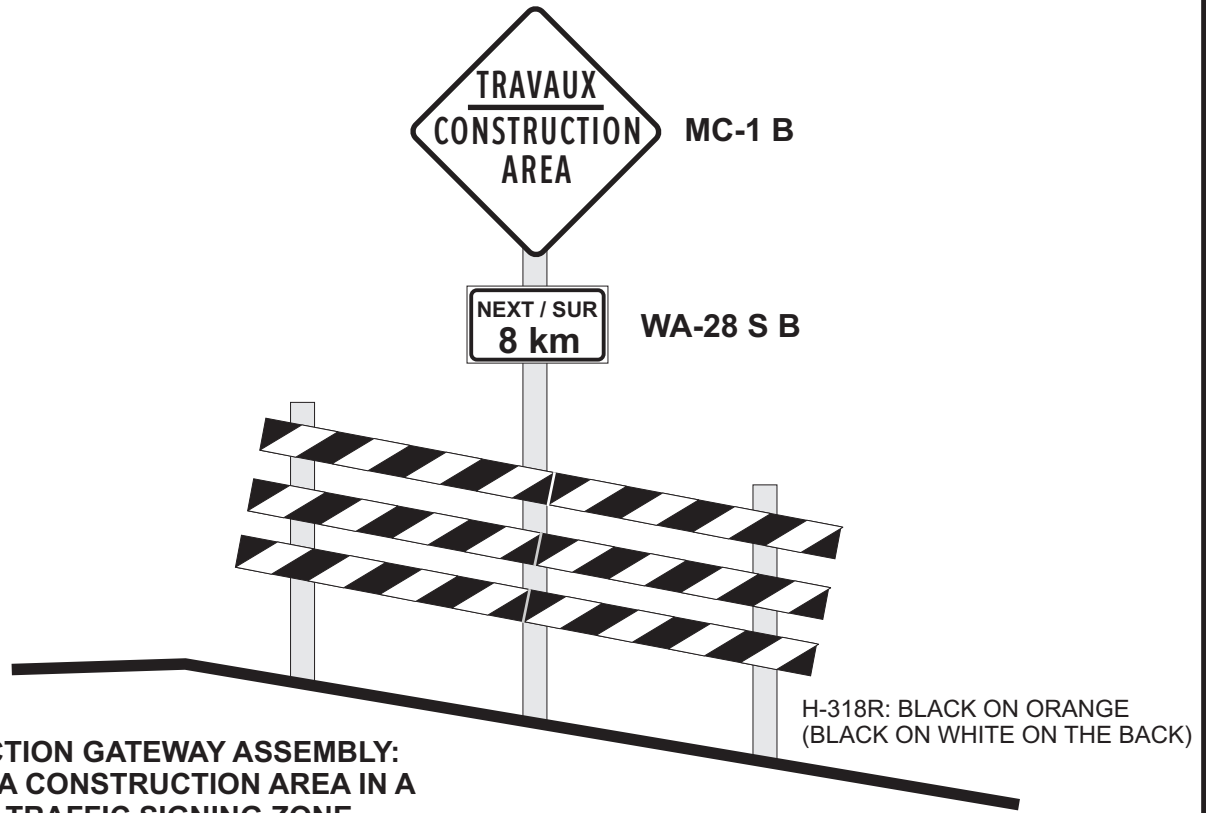

**CONSTRUCTION GATEWAY ASSEMBLY:
ENTERING A CONSTRUCTION AREA IN A
BILINGUAL TRAFFIC SIGNING ZONE**

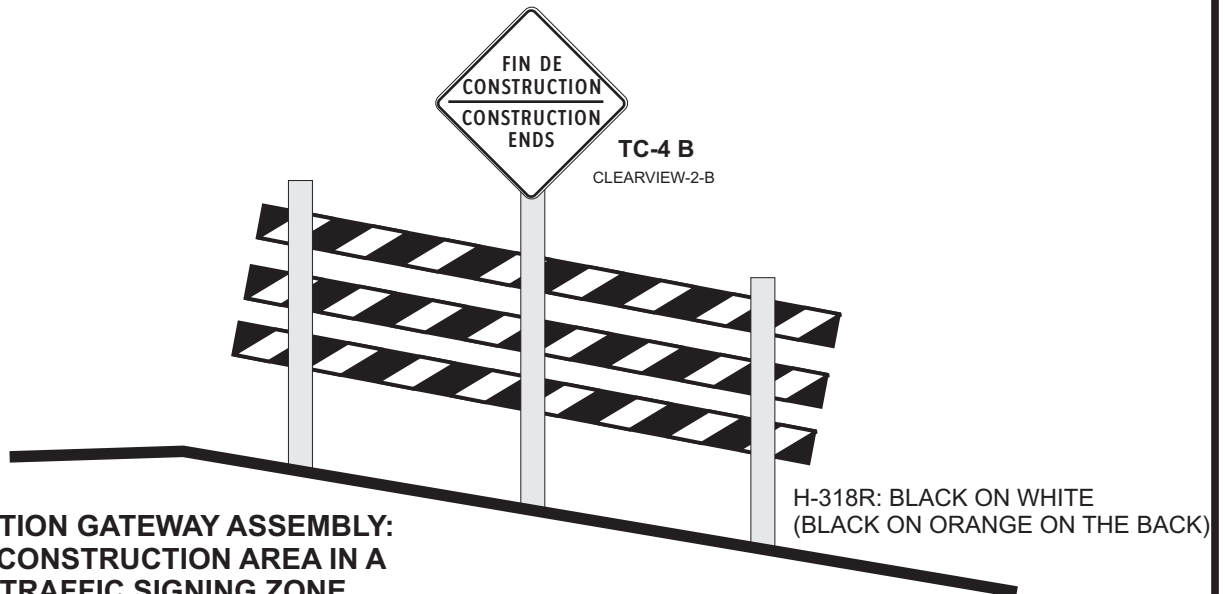

**CONSTRUCTION GATEWAY ASSEMBLY:
LEAVING A CONSTRUCTION AREA IN A
BILINGUAL TRAFFIC SIGNING ZONE**

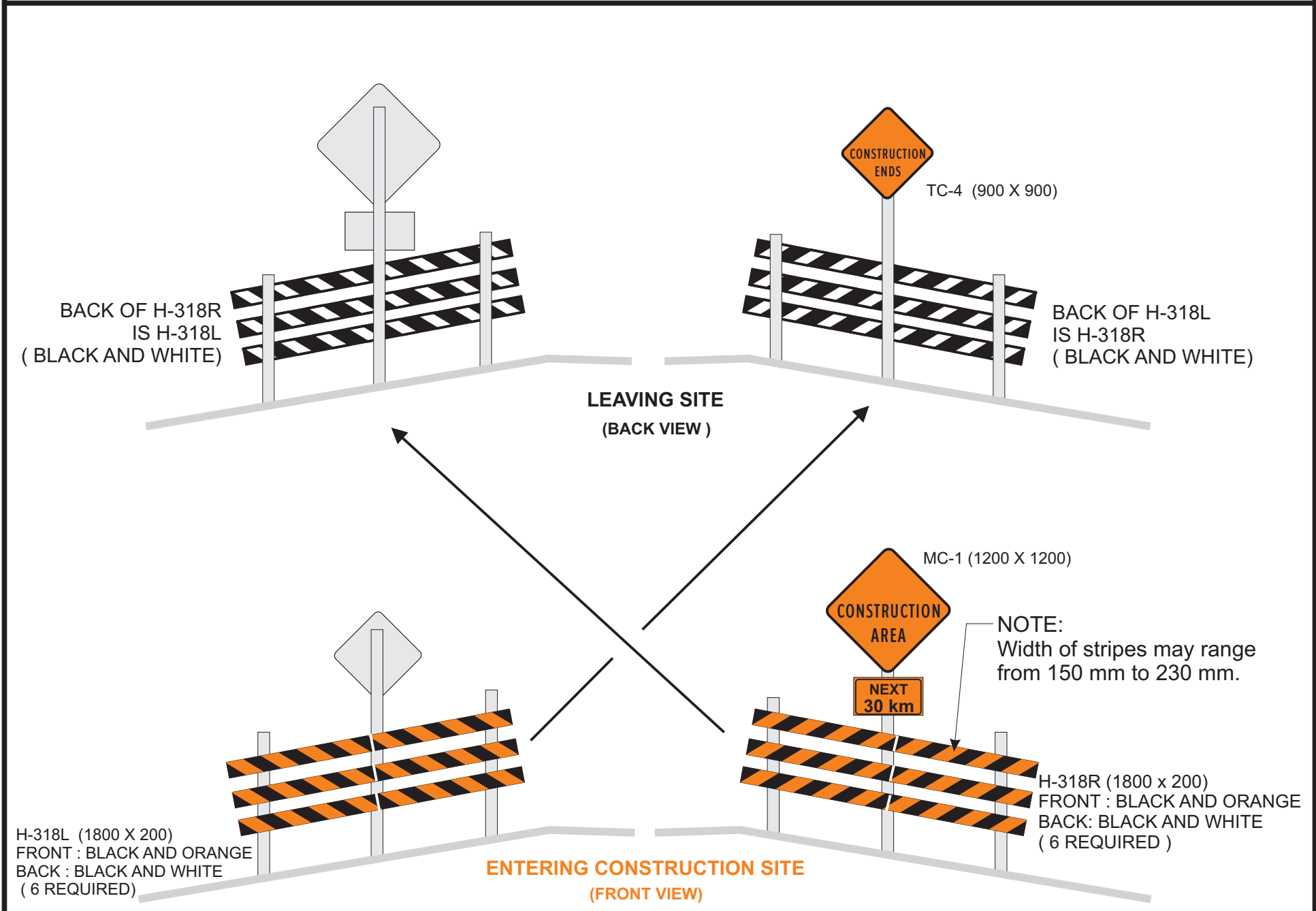

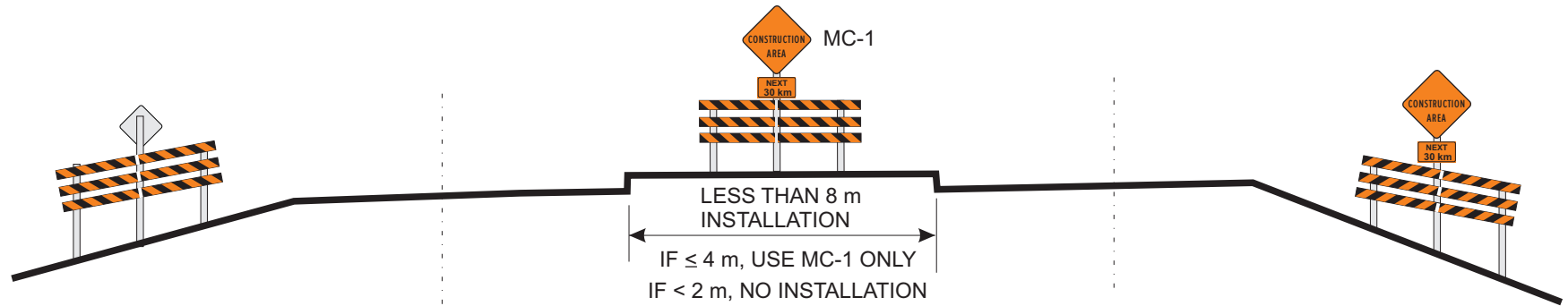

CONSTRUCTION GATE ASSEMBLIES
4-LANE DIVIDED HIGHWAY FORMAT

ENTERING CONSTRUCTION SITE
(FRONT VIEW)

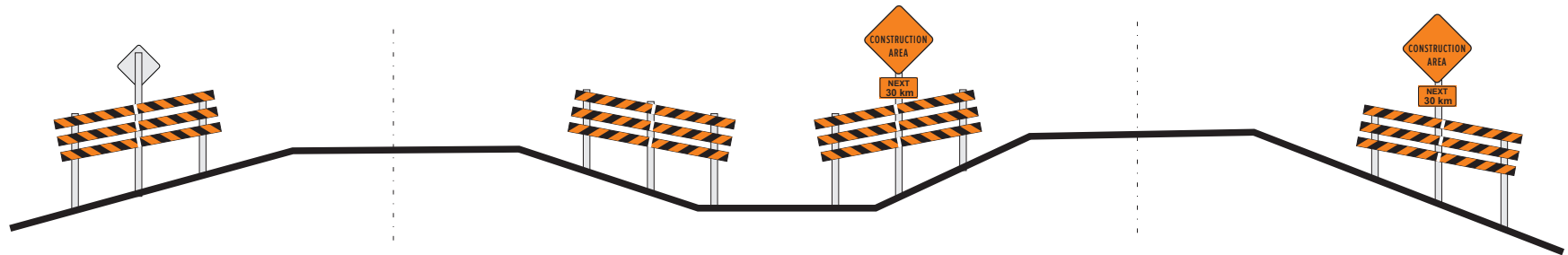

CONSTRUCTION GATE ASSEMBLIES
4-LANE DIVIDED HIGHWAY FORMAT

ENTERING CONSTRUCTION SITE
(FRONT VIEW)

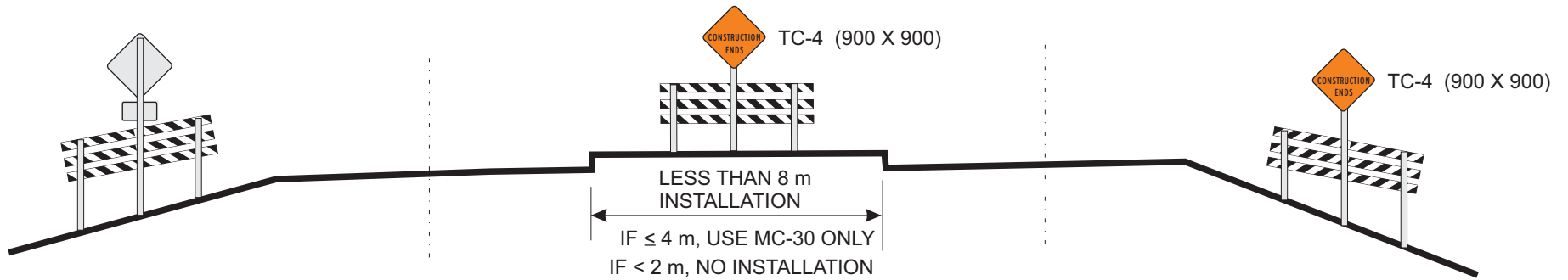

CONSTRUCTION GATE ASSEMBLIES
4-LANE DIVIDED HIGHWAY FORMAT
LEAVING CONSTRUCTION SITE

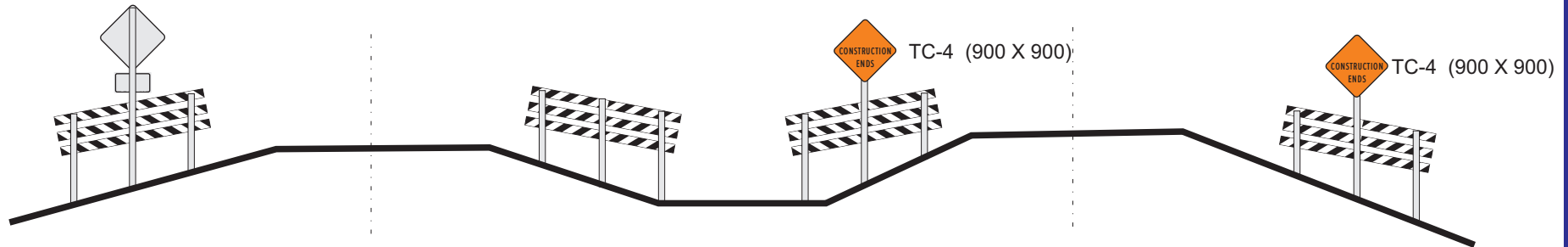

CONSTRUCTION GATE ASSEMBLIES
4-LANE DIVIDED HIGHWAY FORMAT
LEAVING CONSTRUCTION SITE

Traffic Control Device: **Work Zone**

Date of Revision: **March 15, 2002**

Division:

Subject: **Hazard Markers**

Page **1 of 3**

Purpose

Delineation, channelization, and hazard markers warn and alert motorists to hazards associated with construction and maintenance work areas.

Policy

Objects within and adjacent to the roadway which constitute a hazard to traffic require uniform delineation to ensure motorists have sufficient warning to recognise the danger and make a proper response.

Area hazards that require delineation include:

- bridge ends
- excavation areas

Longitudinal hazards that require delineation include:

- gravel windrows
- bench cuts
- pavement edge drop-offs

Standard

Area hazards

Bridge ends and excavation areas must be delineated using either poly posts, drums (900-B-12), or construction markers (H-315T) to ensure motorists have sufficient warning to recognise the hazard and take appropriate action.

RECOMMENDED: "ORIGINAL SIGNED BY" _____
Director, Traffic Engineering

APPROVED: "ORIGINAL SIGNED BY" _____
Executive Director
Highway Engineering

Longitudinal Hazards

Gravel windrows - Construction markers (H-315T) are to be used to delineate all gravel windrows and are to be spaced at 150 m intervals (see TMP-27).

Bench cuts - Construction markers (H-315T) or Department approved reflective poly posts (900-B-12) are to be used to delineate all bench cuts and are to be spaced at 100 m intervals along tangent section of roadway and at 50 m intervals along curves.

Pavement edge drop-offs – Reflective delineators or Department approved reflective poly posts are to be used to delineate all pavement edge drop-offs greater than 50mm in depth and are to be spaced at 100 m intervals along tangent section of roadway and at 50 m intervals along curves.

All channelizers/construction markers are to be located within 600 mm of the drop-off or bench cut.

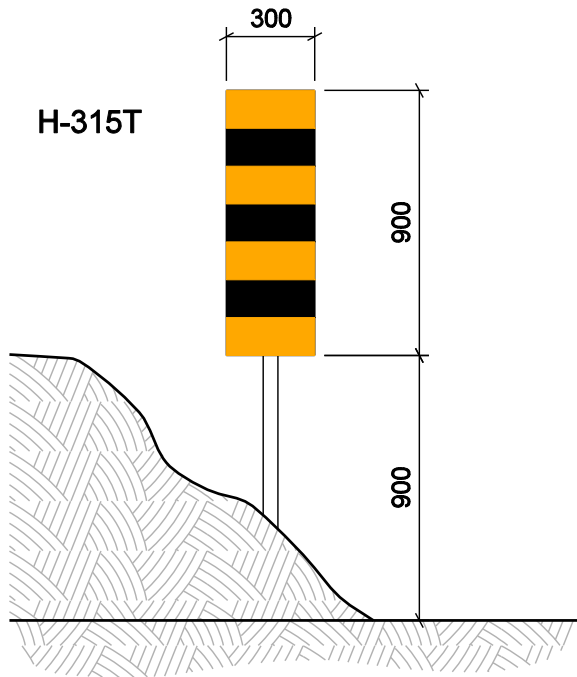

CONSTRUCTION MARKER
DELINEATING A GRAVEL
WINDROW

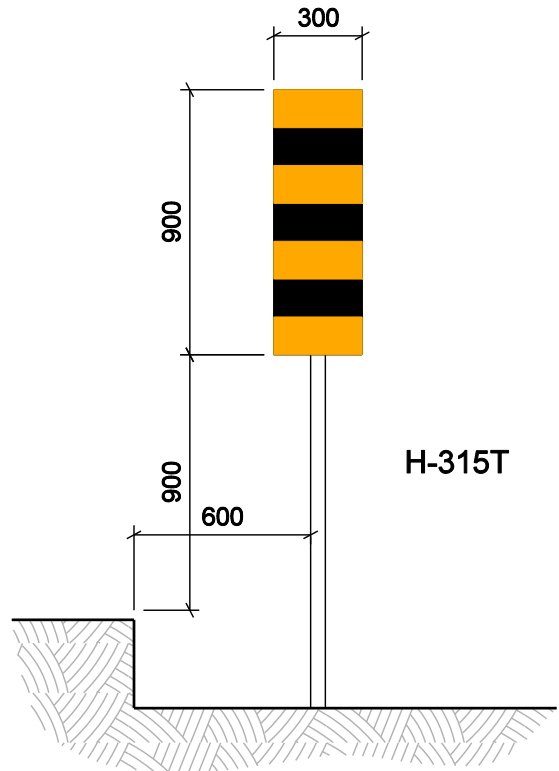

CONSTRUCTION MARKER
DELINEATING A BENCH
CUT

Traffic Control Device: **Work Zone**

Division:

Subject: **Channelizers and Delineators**

Page **1 of 3**

Purpose

There are several devices available which aid in the guidance of motorists through or around a hazardous area, or work zone.

Policy

All devices intended for delineation and channelization purposes must be approved by the Manitoba Infrastructure and Transportation. They must be designed to yield if struck by an errant vehicle, and must conform with the specifications described herein in terms of size, shape, colour, and reflectivity. Unless otherwise directed, only those delineators and channelizers specified in a Traffic Management Plan (TMP) may be installed in a construction and maintenance work zone. **Traffic cones are intended for daytime operations only and must not be used if the traffic control must be left in place overnight.**

Standard

The following devices are generally approved for delineation or channelization.

It is preferable to use plastic drums for lead in tapers.

Plastic Posts ("Polyposts")

Size: 50 mm diameter x 1000 mm, nominal
Shape: Tubular
Colour: Orange post with 200 mm wide white reflective sheeting, nominal
Reflectivity: High Intensity (ASTM – Type III)

Plastic posts ("polyposts") are available in a variety of sizes and can be used as both delineators and channelizers. They can be implanted in the ground or fitted with bases that can be affixed to the pavement. Polyposts yield when struck by vehicles, are self-recovering and can usually withstand numerous impacts. Only approved polyposts may be used in construction and maintenance work zones.

RECOMMENDED: "ORIGINAL SIGNED BY" _____
Director, Traffic Engineering

APPROVED: "ORIGINAL SIGNED BY" _____
Executive Director
Highway Engineering

Traffic Cones

Height: 700 mm, nominal
Shape: Conical with square broadened base
Colour: Orange
Reflectivity: None

Traffic cones are used to channelize traffic and are intended for daytime operations only. **Traffic cones are not reflectorized and must be replaced with different channelizing devices if traffic control is left in place overnight.** Only approved traffic cones may be used in construction and maintenance work zones.

Plastic Drums

Height: 900 mm, nominal
Shape: Rectangular, round or octagonal with square broadened base
Colour: Orange drum with alternate 100 mm wide white and fluorescent orange reflective stripes
Reflectivity: High Intensity (ASTM – Type III)

Plastic drums are generally used in work zones where channelization devices will remain in place for prolonged periods of time. Only approved plastic drums may be used in construction and maintenance work zones.

Concrete Median Barriers

Size: 3 m x 0.5 m x 0.8 m
Shape: F-shaped concrete barriers
Colour: Grey
Reflectivity: None

Barrier ends must be adequately protected so as not to present a hazard to motorists.

Plastic Median Barriers (Triton Barriers)

Size: 2 m x 0.5 m x 0.8 m
Shape: Rectangular
Colour: 2 Colours: Orange and White
Reflectivity: None

Barriers must be alternated by colour (i.e., orange, white, orange, white, etc.) Barrier ends must be adequately protected so as not to present a hazard to motorists.

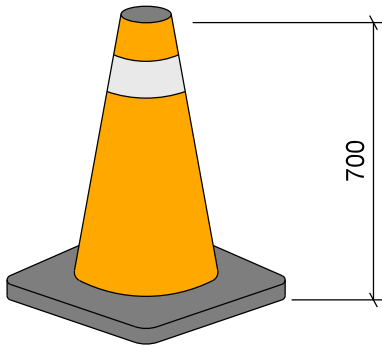

**TRAFFIC CONE
(MINIMUM DIMENSIONS)**

Minimum Reflectivity
Level of ASTM Type IV

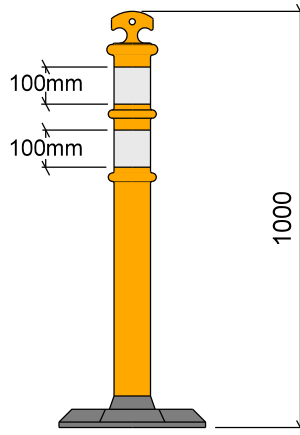

**POLYPOST
(WITH BASE)**

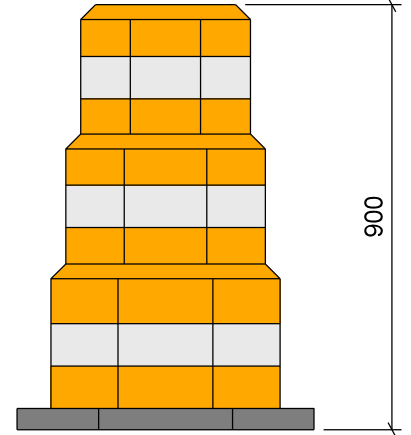
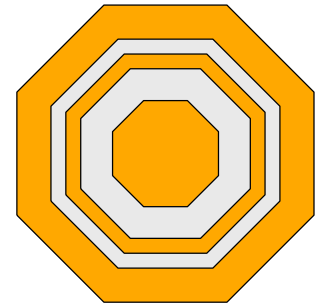

**PLASTIC DRUM
(MINIMUM DIMENSIONS)**

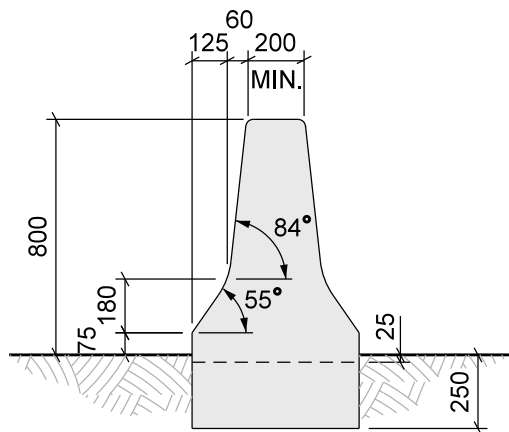

**CONCRETE MEDIAN
BARRIER**

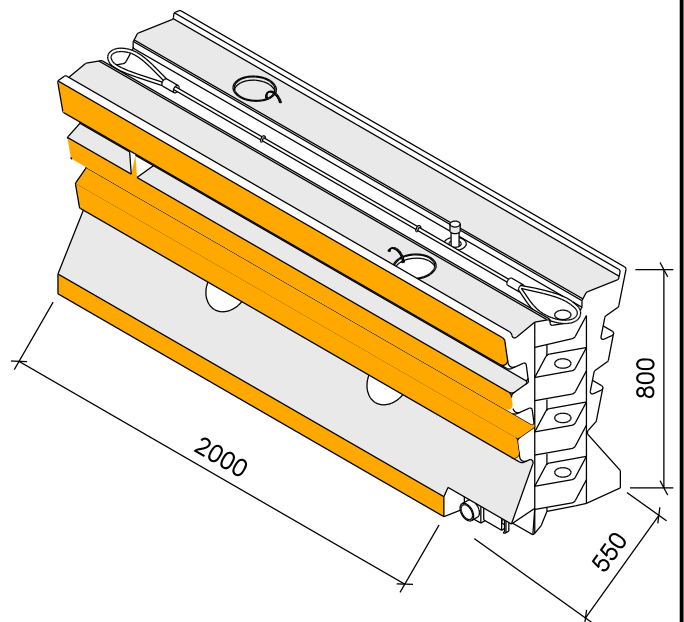

**TRITON BARRIER
(WATER FILLED)**

Traffic Control Device: **Work Zone**

Date of Revision: **January 13, 2006**

Division:

Subject: **Sign Reflectivity**

Page **1 of 1**

Purpose

Retroreflectivity greatly increases the conspicuity of traffic control devices, particularly in low light and reduced visibility conditions.

Policy

Further to Section A1.6.7 of the TAC MUTCD, all signs and other devices used in construction and maintenance work zones must be reflectorized with a material that has a smooth, sealed outer surface which shows the device in approximately the same shape and colour both day and night.

Standard

The retroreflective sheeting material must be at a minimum high intensity grade ASTM D4556 Type III (or approved equivalent), specified. In situations where extra visibility is required, diamond grade retroreflective sheeting may be used, subject to Manitoba Infrastructure and Transportation approval. **Non-reflective fluorescent sheeting material must not be used.** The retroreflective surfaces must be cleaned or replaced as often as necessary to provide full retroreflectivity.

RECOMMENDED: “ORIGINAL SIGNED BY”
Director, Traffic Engineering

APPROVED: “ORIGINAL SIGNED BY”
Executive Director
Highway Engineering

Traffic Control Device: **Work Zone**

Date of Revision: **March 15, 2002**

Division:

Subject: **Maintenance**

Page **1 of 1**

Purpose

Proper maintenance is essential for the desired performance of traffic control devices.

Policy

All signs and other traffic control devices must be monitored to ensure proper location, legibility and condition. If necessary, inadequate devices must be immediately repositioned, repaired or replaced.

Standard

Reflective surfaces must be kept clean at all times and should be checked at the end of each day. Nighttime inspections must be performed periodically to ensure reflective levels are adequate. Signs with inadequate reflective levels must be discarded and replaced.

If the traffic control is left in place overnight, only those signs necessary to protect motorists must remain in place. Non-applicable signs must be removed or covered.

RECOMMENDED: "ORIGINAL SIGNED BY"
Director, Traffic Engineering

APPROVED: "ORIGINAL SIGNED BY"
Executive Director
Highway Engineering

Traffic Control Device: **Work Zone**

Date of Revision: **March 15, 2002**

Division:

Subject: **Enhancement**

Page **1 of 1**

Purpose

Under some circumstances traffic control devices should be enhanced to better draw the attention of motorists. This can be accomplished through several approved methods.

Policy

When conditions dictate, traffic control devices used in a Traffic Management Plan (TMP) may be enhanced to increase the conspicuity of the devices. Care must be taken not to overdo this process as motorist expectation may be effected. All enhancements require approval of Traffic Engineering Branch.

Standard

The following methods may be used, subject to approval, for the enhancement of traffic control devices:

- Oversizing - Increasing the size of temporary condition signs enhances visibility. However, care must be taken not to throw a group of signs out of balance by installing one that is disproportionately large.
- Flags - Fluorescent orange flags can be attached to temporary condition signs.
- Sequential Flashing Arrow Boards - Flasher units **are recommended** to better indicate a closed lane or merge direction. However, since flashers are susceptible to mechanical or electrical failure they must not be used as a primary device. The work zone must be fully controlled with or without the presence of a sequential flasher unit.
- Reposition Devices - Traffic control devices may be relocated laterally or longitudinally to increase their visibility or to enhance the "total effect" as long as they remain within a motorist's cone of vision.
- Illumination - External illumination may be used to increase nighttime visibility.
- Reduce "Clutter" - Existing signs or other traffic control devices that are not necessary to protect motorists should be removed.

RECOMMENDED: "ORIGINAL SIGNED BY" _____
Director, Traffic Engineering

APPROVED: "ORIGINAL SIGNED BY" _____
Executive Director
Highway Engineering

Traffic Control Device: **Work Zone**

Date of Revision: **February 2005**

Division: **Temporary Warning**

Subject: **Protection from Vehicular Traffic – Enhanced Visibility** Page 1 of 1

Purpose

For safety reasons, all workers exposed to vehicular traffic on a project site must be visible to motorists. (See Policy 900-A-4 “Worker Visibility on Roadway”) This includes anyone walking on or adjacent to any roadway that is open to vehicular traffic.

Policy

All workers, whether directly employed by the Manitoba Infrastructure and Transportation or by a contractor doing work on behalf of Manitoba Infrastructure and Transportation, exposed to the hazard of vehicular traffic on a project site on a street, highway, or other roadway, shall wear high-visibility safety apparel that complies with the requirements of CSA Standard Z96-02 High-Visibility Safety Apparel.

RECOMMENDED: “ORIGINAL SIGNED BY” _____
Director, Traffic Engineering

APPROVED: “ORIGINAL SIGNED BY” _____
Executive Director
Highway Engineering

Traffic Control Device: **Work Zone**

Date of Revision: **March 15, 2002**

Division: **Temporary Warning**

Subject: **Traffic Control – Stringline Installation**

Page **1 of 1**

Purpose

During paving operations, the worker installing the stringline in front of the paver requires protection as he/she is continually exposed to the hazard of vehicular traffic.

Policy

A worker installing a stringline on a roadway open to vehicular traffic must be accompanied by at least one flagperson.

Standard

The flagperson should, at all times, be within 10 metres of the stringline person.

RECOMMENDED: “ORIGINAL SIGNED BY”
Director, Traffic Engineering

APPROVED: “ORIGINAL SIGNED BY”
Executive Director
Highway Engineering

Traffic Control Device: **Work Zone**

Division: **Temporary Warning**

Subject: **Traffic Control-Temporary Overlay Markers (TOMs)**

Page **1** of **1**

Purpose

Workers installing temporary overlay markers (TOM's) require protection as they are continually exposed to the hazard of vehicular traffic.

Policy

A worker installing temporary overlay markers (TOM's) on a roadway open to vehicular traffic must be accompanied by at least one flagperson, unless the activity is already being controlled by existing flagpeople.

Standard

The flagperson should, at all times, be within 10 metres of the person installing the TOM's.

RECOMMENDED: "ORIGINAL SIGNED BY"

Director, Traffic Engineering

APPROVED: "ORIGINAL SIGNED BY"

Executive Director
Highway Engineering

Traffic Control Device: **Work Zone**

Date of Revision: **April 14, 2010**

Division:

Subject: **Working Near Railway Crossings**

Page **1 of 2**

Purpose

Working near highway-railway grade crossings presents a special set of traffic control problems. Protection of the travelling public, security of railway operations, and the safety of workers is paramount.

Policy

Whenever a road construction or maintenance activity is carried out **within 100 meters** of an at-grade railway crossing, the appropriate railway must be contacted regarding the operation of the trains to ensure the safety of the grade crossing during such work.

No work on the highway within the railway right-of-way may take place without specific approval of the railway (except for routine “through” operations such as highway snow clearing operations, road marking, etc.).

Standard

Notification should be given to the railway whenever possible, at least 72 hours prior to commencement of work, advising of the crossing location, and the nature and duration of the work.

Required temporary traffic control devices must be carefully placed so they do not detract from the visibility or impact of Railway Crossing signs (Crossbucks), Advance Railway Crossing signs, or Automatic Crossing Protection, if installed.

When Automatic Crossing Protection is in place, railway signals must never be operated manually by the rail authority to warn motorists that there is construction or maintenance taking place. Signals should only operate when a train causes them to operate, or during maintenance or construction **of the signals themselves**.

Parked equipment and vehicles should not be within 30 m of railway tracks and must not be parked as to obstruct the sightlines of warning signals or other traffic control devices.

When possible, the railway will put a “block” on the tracks in the area where roadwork is taking place. The “block” stops all trains from using the affected section of the tracks for the time allotted.

RECOMMENDED: “ORIGINAL SIGNED BY”
Director, Traffic Engineering

APPROVED: “ORIGINAL SIGNED BY”
Executive Director
Highway Engineering

Where a track cannot be “blocked”, the railway must station "train" flagpeople, with appropriate training and regalia, at the grade crossing to ensure safe operation of the crossing. The cost of these flagpeople would normally be the Department’s responsibility.

No flagperson, whether directly employed by the Manitoba Infrastructure and Transportation or by a contractor doing work on behalf of the Manitoba Infrastructure and Transportation, is allowed to “flag” vehicles over any railway crossing. Where flaggers are in place, they should stop roadway traffic and advise drivers when they see a train approaching, **but should not tell them when it is safe to cross. Instead, they should advise the driver to cross when he/she feels it is safe to do so.** Drivers must make this decision themselves.

CONTACT LIST FOR RAILWAYS IN MANITOBA

CN RAILWAY:

AREA	NAME	CELL PHONE
BRANDON-SOUTH	HETHERINGTON, BRIAN	573-6281
ANOLA	SORENSEN, JOHN	981-3036
WINNIPEG-NORTH	KOPP, KEVIN	771-5636
DAUPHIN	LAVALLEE, RAY	638-2467
STE. ANNE	SHORT, RICHARD	479-2036
WINNIPEG-SOUTH	KOPP, KEVIN	771-5636
BRANDON-NORTH	ANTUNES, ADELINO	729-5585

CP RAILWAY:

AREA	NAME	CELL PHONE
WINNIPEG -EAST	CHASSIE, VIC	807-467-4981
WINNIPEG-NORTH	MORDEN, DWIGHT	729-6938
WPG TO BRANDON	MORDEN, DWIGHT	729-6938
WINNIPEG - CENTRAL	REID, TERRY	771-0085
WINNIPEG-SOUTH	REID, TERRY	771-0085
MINNEDOSA	THEISEN, RON	729-5972
BRANDON -WEST	LOEWEN, GORD	725-9661
SOURIS/LARIVIERE	ANDERSON, NEIL	729-5008

Hudson Bay Railway – MARK WNDLING – 620-1876

Greater Winnipeg Water District (GWWD) –Dave Carr – 986-4884
(emergency number 986-4781)

Central Manitoba Railway – Jerry Blowatt - 794-6571

Prairie Dog Central – DOUG DILLON – 802-1582

Boundary Trail Railway Company – Travis Long - 242-4201

Traffic Control Device: **Work Zone**

Division: **Temporary Warning**

Subject: **Traffic Control – Paving Operation**

Purpose

During paving operations, workers on and alongside the paver require protection as they are continually exposed to the hazard of vehicular traffic.

Policy

One flagperson (see Policy 900-B-2 “Flagpersons”) must accompany the self-propelled mechanical paver whenever the paver is operating on a roadway open to vehicular traffic.

Standard

The flagperson should, at all times, be within 10 metres of the paver.

RECOMMENDED: “ORIGINAL SIGNED BY”
Director, Traffic Engineering

APPROVED: “ORIGINAL SIGNED BY”
Executive Director
Highway Engineering

Traffic Control Device: **Work Zone**

Division:

Subject: **Temporary Storage of Poles, Culverts, etc. in Right-of-Way** Page 1 of 2

Purpose

Delineation of rigid construction materials, such as culverts and utility poles, temporarily stored in Department right-of-way is required to alert operators of off-road vehicles and motorists of the potential hazard.

Policy

It is occasionally necessary to temporarily store rigid construction materials, such as culverts and utility poles, in Department right-of-way before installation proceeds. These objects should be stored as far from the roadway travel lane as practical, with the following requirements:

- Rigid materials should be stored in the right-of-way for as short a period as practical.
- Rigid materials must not be stored within 4 meters of the travel lane.
- Where rigid materials are temporarily stored within the roadway "Clear Zone" (12 metres from the edge of the travel lane), the area must be signed and delineated as a work zone. This would normally consist of a "construction area" sign with poly-posts or cones.
- Where rigid materials are temporarily stored outside the "Clear Zone" but within Department right-of-way, they must be delineated.

Standard

Poly-posts or cones with retroreflective sheeting should be used to delineate all rigid materials temporarily stored in Department right-of-way. Where poly-posts or cones are unavailable or impractical to use, a 75 mm x 75 mm (3 inch x 3 inch) fluorescent orange prismatic reflective material should be installed, at a minimum height of 600 mm (2 feet) above the ground surface.

RECOMMENDED: "ORIGINAL SIGNED BY" _____
Director, Traffic Engineering

APPROVED: "ORIGINAL SIGNED BY" _____
Executive Director
Highway Engineering

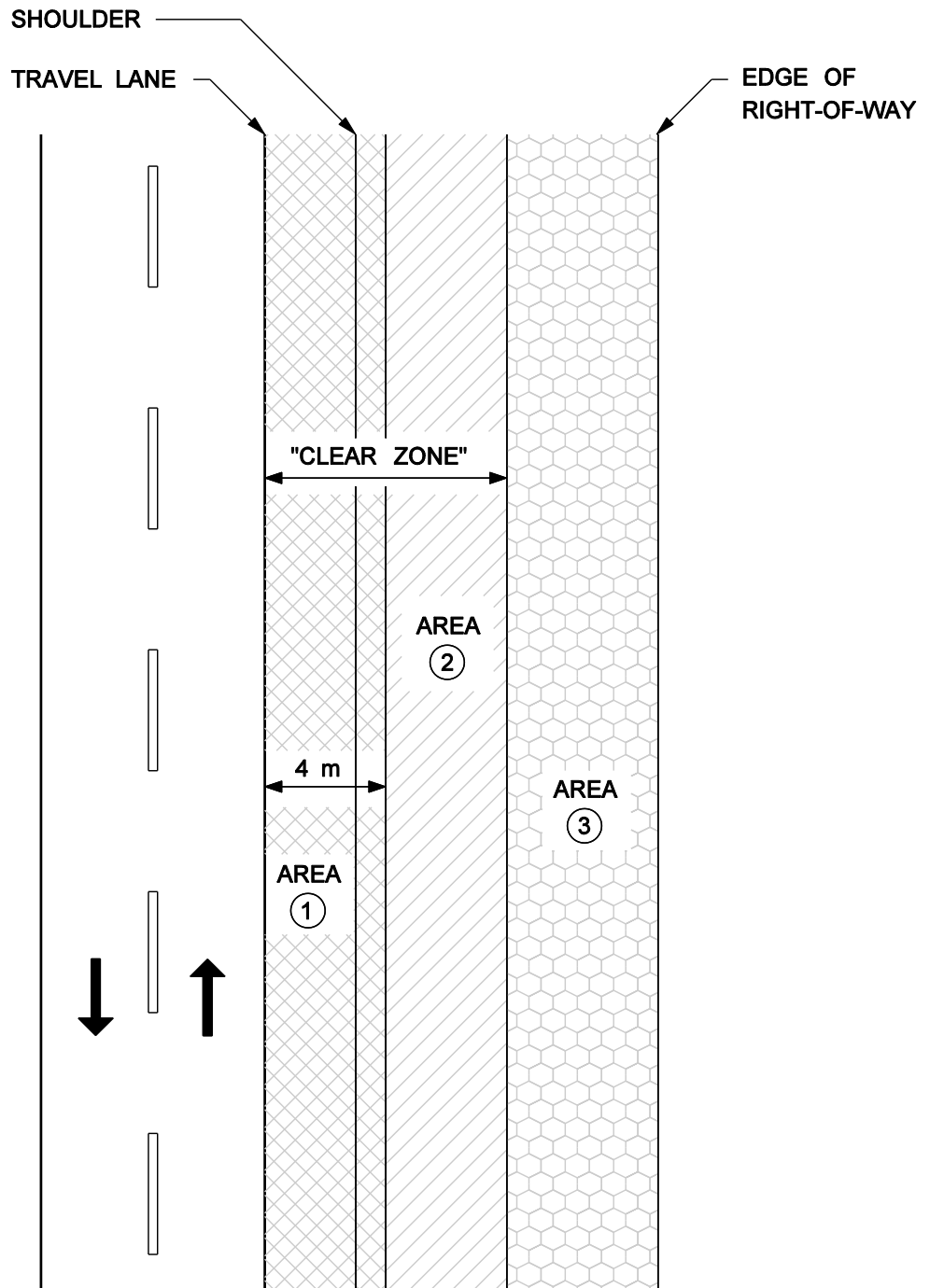

- AREA 1.**
STORAGE NOT ALLOWED
- AREA 2.**
POLES, CULVERTS, ETC. STORED IN THIS AREA
MUST BE SIGNED & DELINEATED
- AREA 3.**
POLES, CULVERTS, ETC. STORED IN THIS AREA
MUST BE DELINEATED

Traffic Control Device: **Work Zone**

Date of Revision: **March 15, 2002**

Division:

Subject: **Traffic Management Plans**

Page **1 of 1**

Purpose

Traffic management and work activities must be coordinated in work zones to provide safe and expeditious movements of traffic while maintaining efficient work progress. Traffic controls in work zones warn of potential hazards, separate motorists from the work force and delineate a path for traffic to follow. Work zone traffic control devices are not normally used singly, but are applied as a system of devices. The development of a Traffic Management Plans (TMP) and the correct deployment of traffic control devices are key elements in achieving safe conditions within construction and maintenance work zones.

Policy

A TMP, in sufficient detail to reflect the complexity of the construction and maintenance work and traffic conditions, must be prepared and put into operation before the site is occupied.

Standard

A series of typical TMP have been developed to aid in the implementation of traffic management within work zones.

These typicals are minimum standards which can be enhanced to deal with local conditions. Refer to TMP drawings.

RECOMMENDED: "ORIGINAL SIGNED BY"
Director, Traffic Engineering

APPROVED: "ORIGINAL SIGNED BY"
Executive Director
Highway Engineering

Traffic Control Device: **Work Zone**

Date of Revision: **March 15, 2002**

Division:

Subject: **Traffic Control Coordinator**

Page **1 of 1**

Purpose

The implementation of a Traffic Management Plan (TMP) requires dedicated staff trained in the appropriate principles and guidelines of the Traffic Management Plan.

Policy

One person on each traffic control project, hereafter designated as the "traffic control coordinator", must have overall responsibility for implementing the TMP and ensuring that the plan is functioning properly.

Standard

The duties and responsibilities of the traffic control coordinator include, but are not limited to:

- ensuring that only those traffic control devices approved by the Manitoba Infrastructure and Transportation and called for by the TMP are used in a work zone
- ensuring that the guidelines of the Policies/Standards are met
- installing, positioning, relocating or removing traffic control devices as conditions change
- maintaining traffic control devices and ensuring their reflective surfaces are clean
- training flagpersons
- organizing and supervising the development and relief of flagpersons
- ensuring that flagpersons are properly informed concerning road conditions and that they are relaying the proper information

Since traffic control coordinators' actions affect construction and maintenance work zone safety every traffic control coordinator should receive training appropriate to their position. Only those who are qualified by means of adequate training in safe traffic management practices, and have a basic understanding of the principles established by the applicable Policies/Standards may be appointed to supervise the selection, placement, and maintenance of traffic control devices and train flagpersons. Completion of a Manitoba Infrastructure and Transportation sanctioned training course is highly recommended for all traffic control coordinators.

RECOMMENDED: "ORIGINAL SIGNED BY"

Director, Traffic Engineering

APPROVED: "ORIGINAL SIGNED BY"

Executive Director
Highway Engineering

Traffic Control Device: **Work Zone**

Date of Revision: **March 15, 2002**

Division:

Subject: **Work Zone Components**

Page **1 of 2**

Purpose

A work zone consists of the section of the roadway between the first advance warning sign and the point beyond the activity area where traffic is no longer affected. Most work zones can be divided into five areas as described below.

Policy

All work zone Traffic Management Plans (TMP) will be designed to include the five areas of a work zone traffic control zone.

- Advance Warning Area
- Transition Area
- Buffer Space
- Activity Area
- Termination Area

Standard

Advance Warning Area

An advance warning area is required for all work zones to alert motorists to the road work ahead. Motorists need enough time and distance to adjust to the altered conditions prior to reaching them. The warning area may vary from a single traffic control device, such as a ROAD WORK sign (TC-2), to a series of traffic control devices.

Transition Area

When redirection of the driver's normal path is required, traffic must be channelized from the normal path to a new path. This redirection is intended to occur at the beginning of the transition area. In mobile operations, this transition area moves with the work space. Transition areas usually involve strategic use of tapers, which (because of their importance) are described in Policy/Standard 900-C-4.

RECOMMENDED: "ORIGINAL SIGNED BY"
Director, Traffic Engineering

APPROVED: "ORIGINAL SIGNED BY"
Executive Director
Highway Engineering

Buffer Space

The buffer space is an open and unoccupied space between the transition area and the work area. The buffer space provides a margin of safety for both motorists and workers. It must be designed to provide adequate stopping sight distance from the middle of the lane closure taper to the beginning of the work area. The buffer space must be coned or otherwise channelled off at all times and free of workers, equipment, and material.

Activity Area

The activity area is that portion of the roadway closed to traffic and set aside for exclusive use by workers, equipment, and material. Activity areas may be in fixed locations or may move as the work progresses. In mobile operations, extra care must be taken to ensure that an adequate buffer space is left between the work area/vehicle and the trailing buffer vehicle.

Termination Area

The termination area provides the distance necessary for traffic to clear the work area and return to the normal traffic lanes. A downstream taper placed in the termination area indicates that vehicles can move back into the closed lane(s) and helps smooth the flow the traffic.

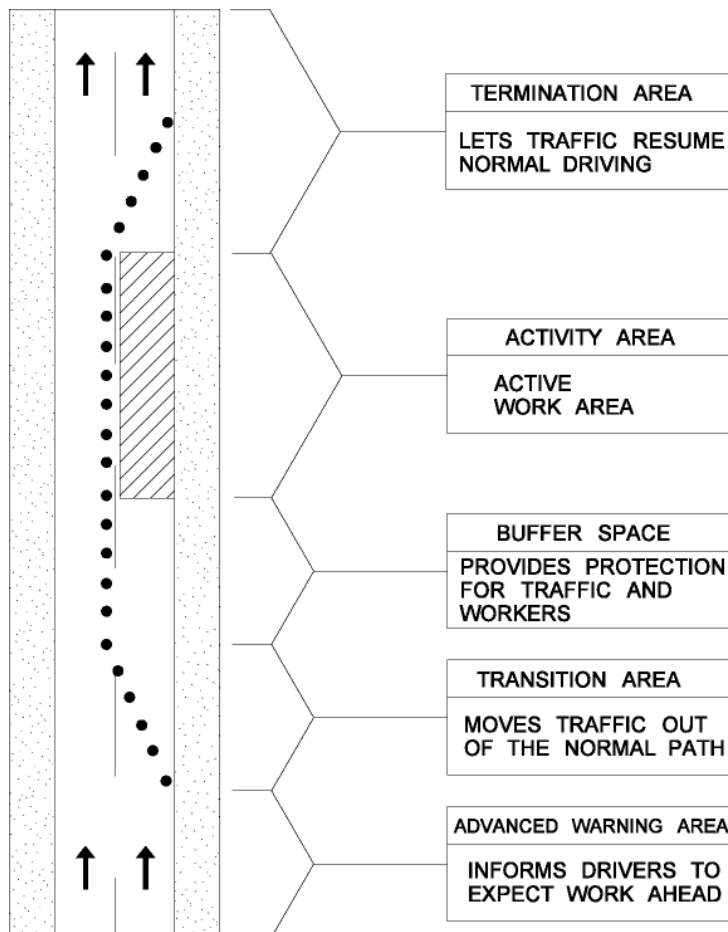

Traffic Control Device: **Work Zones**

Date of Revision: **March 15, 2002**

Division:

Subject: **Transition Tapers**

Page **1 of 2**

Purpose

Transition tapers are used to channel/direct traffic around an activity area within a work zone. The length of the taper and the channelizer spacing is extremely important. Inadequate tapers result in undesirable traffic movements and increase the potential for accidents.

Policy

Whenever traffic must be moved from the normal path of travel due to the presence of an activity area, a proper transition taper must be installed.

The transition area must be obvious to motorists, and must be delineated with channelizing devices so motorists do not mistakenly follow the wrong path. For long duration projects, existing pavement markings must be removed where they conflict with transition delineation. Additional pavement markings may need to be installed to guide motorists.

Standard

There are four common transition tapers as described below. The included table provides normal taper lengths for the taper types and posted speed limits.

- **Merging Taper** - Merging tapers, used on multi-lane divided roadways to channel traffic from a closed lane into an adjacent lane, require the greatest length. A merge lane must allow a motorist to locate and move into a gap in the adjacent traffic stream.
- **Shifting Taper** - When a merge is not required, a shifting taper is used to channel vehicles onto a different travel path. This taper is often used when traffic is routed around a work area by shifting it onto the shoulder or median. Changes in the travel path may also be accomplished with horizontal curves designed for normal highway speeds.
- **One-Lane Traffic Taper** - A one-lane traffic taper is used in advance of work areas that require a portion of the road be used alternately by traffic in both directions. Traffic is typically controlled by flagpersons and since no merging is taking place, the taper used to direct vehicles onto the one-way road section can be quite short.

RECOMMENDED: "ORIGINAL SIGNED BY" _____
Director, Traffic Engineering

APPROVED: "ORIGINAL SIGNED BY" _____
Executive Director
Highway Engineering

- **Downstream Taper** - A downstream taper is placed at the end of the work zone to indicate that vehicles can safely move back onto the lane that was closed. They are placed in the termination area and are the same length as one-lane traffic tapers.

TRANSITION AREA TAPER LENGTHS & CHANNELIZER SPACINGS

Posted Speed (km/h)	MERGING TAPER		SHIFTING TAPER		ONE-LANE TAPER	
	Min. Length (m)	Channelizer Spacing (m)	Min. Length (m)	Channelizer Spacing (m)	Min. Length (m)	Channelizer Spacing (m)
100	250	20	100	10	25	5
90	200	20	100	10	25	5
80	175	15	80	10	25	5
70	120	15	80	10	25	5
60	90	15	50	5	25	5
50	60	15	50	5	25	5

Traffic Control Device: **Work Zone**

Date of Revision: **March 15, 2002**

Division:

Subject: **Installation and Removal of Traffic Control Devices**

Page **1** of **2**

Purpose

The installation and removal of temporary traffic control zones creates a situation which is often far more hazardous than the operation of the completed zone. The workers placing these advance warning devices and channelizing devices must be on the roadway at these points of high conflict. Furthermore, the placement operation constitutes a more unexpected situation for the motorist than does the work zone itself. To minimize these hazards, it is essential that the installation proceed in an orderly fashion and be accomplished as quickly as possible.

Policy

Installation and removal of traffic control devices must be done in a manner which causes the least risk to traffic and which provides for the safety of workers installing or removing devices.

Standard

Installation Sequence

Devices are installed in the direction that traffic moves - this is, "downstream". The first device placed is the first advance warning sign, typically ROAD WORKS (TC-2). The installation then proceed with the:

- Advance Warning area
- Transition area
- Buffer area
- Activity area
- Termination area

Installation Procedure

The traffic control crew must disembark from their vehicles in a safe manner. All personnel must be attired properly to work on the roadway.

RECOMMENDED: "ORIGINAL SIGNED BY" _____
Director, Traffic Engineering

APPROVED: "ORIGINAL SIGNED BY" _____
Executive Director
Highway Engineering

The vehicle being used to haul traffic control devices must be equipped with a minimum of a rotating beacon or strobe. (Higher level lighting is recommended on four-lane divided and high volume two-lane roads.) All lights must be turned on while on the road or shoulder. Four-way flashers and headlights are recommended at all times.

The devices truck or service vehicle acts as the advance warning device for the installation of the first devices and should be located upstream of the workers installing the first devices.

A second or shadow vehicle is recommended for high volume roads and all four-lane roads. This vehicle should be located 150 m upstream of the devices truck and have high level lighting such as sequential flashers on four-lane roads. When no shadow vehicle is used then a flagperson is required for the installation of the tapers.

Tapers are laid out in a straight line starting at the shoulder. Each device is installed in sequence moving downstream. The devices should be moved laterally out from the shoulder with the worker looking toward traffic as he or she moves out into the lane of traffic.

Sign Placement

All long term signs should be mounted on wood posts. The bottom of the sign must be 1.5 m above the pavement surface and two to four metres from the edge of the shoulder.

All temporary signs must be mounted on approved portable sign stands at a minimum height of 600 mm from the road surface to the bottom of the sign.

Signs should be erected with their face turned 0 to 5 degrees away from the road to reduce glare from reflected headlights.

Modification and Removal

When possible, temporary traffic control zones should be modified or removed in the reverse order of installation. This requires crews to move upstream or against traffic through the work zone. If using a vehicle to pick up devices, the vehicle must have its headlights on high beam and the crew must take extra care when turning the vehicle around.

Where there are no shoulders, or where room does not allow vehicles to move against traffic safely, the removal of advance warning signs should be made in the downstream direction. A shadow vehicle must be used in all situations where devices are picked up going in the downstream direction.

Traffic Control Device: **Work Zone**

Date of Revision: **March 15, 2002**

Division:

Subject: **Speed Limits in Construction and Maintenance Areas** Page 1 of 2

Purpose

From time to time it may be necessary to control traffic speeds in construction or maintenance areas by the use of regulatory speed limits.

Under Section 79(6) of The Highway Traffic Act, the Minister of Infrastructure and Transportation as traffic authority may set the maximum speed at which vehicles may be driven on a highway. This authority has been delegated to the Director of Traffic Engineering for construction or maintenance areas only.

Policy

The Director of Traffic Engineering may approve temporary regulatory speed limits in construction and maintenance areas on an individual basis, when the following criteria are met:

- **It is unsafe or impossible to drive at the existing posted speed limit due to construction roadway conditions which exist over the full 24 hour day.**

AND

- **Standard construction signing is inadequate to convey to motorists that ongoing speed reduction is required over a long section of highway.**

Other conditions or hazards which may warrant regulatory speed limits:

- Severe geometric constraints throughout the construction or maintenance area will exist over a long period of time and over a long section of highway, e.g. two-lane two-way (2L2W) traffic on a normal four-lane divided highway.
- Unusual hazards will exist over extended periods of time and over a long section of highway, which can best be handled by speed limits, e.g. flying stones, unexpected dust conditions, large aggregate.
- Speed control by the use of MAXIMUM 60 WHEN PASSING WORKERS signs (MR-96) is inapplicable or ineffectual.

RECOMMENDED: "ORIGINAL SIGNED BY"
Director, Traffic Engineering

APPROVED: "ORIGINAL SIGNED BY"
Executive Director
Highway Engineering

- Major speed differentials will exist over extended periods of time between normal highway traffic and construction **vehicles**, e.g. haul roads with high traffic volumes.

Note: This does not normally refer to construction **equipment** such as rollers, packers, graders, scrapers, etc. which may reasonably be expected to travel at very slow speeds in construction areas, where speed control by MAXIMUM 60 WHEN PASSING WORKERS signs is appropriate.

- Bridges or other structures, which for structural reasons, will not safely carry traffic at the existing posted speed limit.

Procedures

Approval for speed limits must be in writing from the Director of Traffic Engineering.

Use of speed limit signs must be limited to those specific sections of highway where problems exist. They must **NOT** be used throughout a project unless the previously listed conditions or hazards dictate.

Speed limit signs must be removed immediately when the conditions change or hazards no longer exist.

Advance speed limit signs (RB-5) must always be used.

All speed limit signs should be enhanced by red warning flags.

Speed limit signs should be repeated at minimum 1 km intervals, and following intersections.

Any other existing speed limit signs should be removed or covered for the duration of this temporary speed limit.

At the end of the speed limit area, a sign must be installed confirming the return to the existing posted speed limit.

Note: These approved speed limits in construction and maintenance areas are enforceable by R.C.M.P. or local police.

Traffic Control Device: **Work Zone**

Division:

Subject: **Maximum 60 When Passing Workers Sign**

Page **1** of **1**

Purpose

It may be necessary to control traffic speeds while they are passing workers in construction or maintenance areas.

The MAXIMUM 60 WHEN PASSING WORKERS sign is a regulatory and enforceable speed limit as identified under Section 56 (1) of The Highway Traffic Act.

Policy

MAXIMUM 60 WHEN PASSING WORKERS signs may be installed in any active work zones where there is a need to have traffic speeds reduced below the existing regulatory speed limit.

Standard

The MAXIMUM 60 WHEN PASSING WORKERS sign, when required, should be installed as close to the beginning of the active work zone as practical (See TMP-11, TMP-13, TMP-14, TMP-15 and TMP-16 for typical placement).

MAXIMUM 60 WHEN PASSING WORKERS sign should be used when working within the Clear Zone. The Clear Zone requirement is 12.0 metres from the edge of the travel lane.

The MAXIMUM 60 WHEN PASSING WORKERS sign should not be more than 500 meters from the active work zone and should be removed when workers are not present.

This sign should not normally be required where:

- The regulatory speed limit is less than 70 km/h
- There is a flagperson controlling traffic

If MAXIMUM 60 WHEN PASSING WORKERS sign is not applicable see Policy 900-C-6 "Speed Limits in Construction and Maintenance Areas".

Note: The Maximum 60 When Passing Workers signs are enforceable by R.C.M.P. or local police.

RECOMMENDED: "ORIGINAL SIGNED BY"
Director, Traffic Engineering

APPROVED: "ORIGINAL SIGNED BY"
Executive Director
Highway Engineering

Traffic Control Device: **Work Zone**

Date of Revision: **March 15, 2006**

Division:

Subject: **Pilot Vehicle Traffic Control**

Page **1 of 2**

Purpose

The use of Pilot Vehicles through work areas can be effective where required due to sight restrictions, extended active work zones, hazardous construction activities, or other factors.

Policy

Pilot vehicle traffic control according to the following standards, may be appropriate when other less intrusive control is deemed to be inadequate or ineffectual. In order to be effective, the reasons for Pilot Vehicle traffic control need to be apparent to motorists passing through the work zone. Due to additional costs and inherent delays to traffic, Pilot Vehicle traffic control decisions demand careful scrutiny and review, and unless specified in the Work Zone Manual for certain activities, need to be considered on a case by case basis.

Standard

- See Work Zone TMP-26 for “Traffic Control Using a Pilot Vehicle” traffic control details.
- The numbers of Pilot Vehicles needs to be appropriate in order to limit queue build-ups and motorist delays, considering:
 - Length of Pilot Vehicle controlled area
 - Traffic volumes
 - Pilot Vehicle travel speeds.
- Where Pilot Vehicle traffic control is in place, approaching traffic volumes need to be continuously monitored to ensure vehicle queues do not “over-run” the required sequence of advance warning signs, flagger stations, etc. This may necessitate ongoing communications between flaggers, and between flaggers and project traffic control supervisor(s).
- Where queue lengths are expected to grow beyond one flagger’s abilities to control traffic flow, additional flagger(s) will be required. This needs to be anticipated so that stand-by flaggers are readily available.
- Additional advance signing will also be required if queues extend beyond the local initial traffic control area.

RECOMMENDED: “ORIGINAL SIGNED BY” _____
Director, Traffic Engineering

APPROVED: “ORIGINAL SIGNED BY” _____
Executive Director
Highway Engineering

- The extent of the area under Pilot Vehicle traffic control must be limited in order to:
 - reduce queuing times and delays
 - reduce project costs (by limiting numbers of the required Pilot Vehicles)
 - reduce queuing hazards such as rear-end collisions
 - maintain motorist patience and “buy-in” for the attendant delays
- Variable Message Signs (VMS) should always be considered in order to provide additional “high level” advance warning to approaching traffic. The preferred message is “Prepare to Stop xx km.” Consult Traffic Engineering for other particular messages relating to local conditions or problems.
- Pilot Vehicle drivers must obey all rules of the road, and adhere to the directions of flaggers and all other work zone traffic controls, **including posted speed limits.**
- Pilot Vehicle drivers must tailor their accelerations and travel speeds according to the mix of traffic and to road conditions in order to avoid undesirable gaps in the vehicle platoon and subsequent overtaking and “catch up” speeding actions by following vehicles.
- For typical sign placement and lighting, see drawing below.

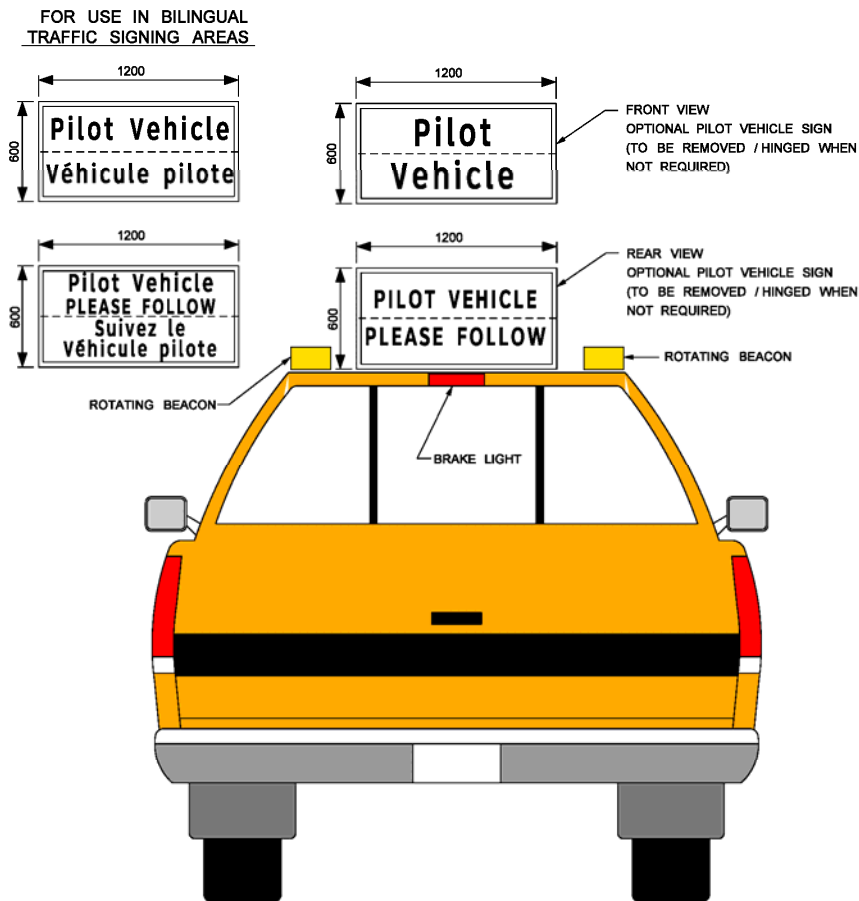

Traffic Control Device: **Work Zone**

Date of Revision: **March 15, 2002**

Division:

Subject: **Traffic Control on Low Speed Roads**

Page **1 of 1**

Purpose

Protection of the travelling public and the safety of workers is paramount. However these must be weighed against the cost and time involved with the installation and removal of the necessary traffic control devices. Traffic control in low speed areas requires special consideration particularly at intersections and where a number of accesses are present.

Policy

Special traffic management strategies are required on Provincial Trunk Highways and Provincial Roads where posted speed limits are 60 km/h or lower when work is being done or in the vicinity of the road surface by Department staff, utilities, or contractors.

Standard

The Traffic Engineering Branch or the Regional Safety Training Facilitator should be contacted to discuss traffic control options.

RECOMMENDED: "ORIGINAL SIGNED BY"

Director, Traffic Engineering

APPROVED: "ORIGINAL SIGNED BY"

Executive Director
Highway Engineering

Traffic Control Device: **Work Zone**

Date of Revision: **March 15, 2002**

Division:

Subject: **Off-Road Operations**

Page **1 of 1**

Purpose

Off-road operations include all activities which are done away from the surface of the road but within the right-of-way. The duration of the operation is typically greater than ten minutes. Safety of the motorist and workers requires that some form of advance warning be provided and maintained.

Protection of the travelling public, and the safety of workers is paramount. However, these must be weighed against the cost and time involved with the installation and removal of the necessary traffic control devices.

Definition

Off Road Operations - Include any operation where **the activity is off the road surface but within the highway right-of-way**. Off-road operations include maintenance activities including culvert cleaning, sign installation, and any other activity including work done by utilities where workers are exposing the motorist to possible hazards off the road surface.

Policy

Where work using workers and/or equipment is being done on any Provincial Trunk Highway or Provincial Road, away from the road surface but within the highway right-of-way, and the duration of that work is greater than 10 minutes, a minimum level of traffic control must be established and maintained for the time that workers or equipment are present.

Standard

Traffic control must consist of at least the minimum installation as described in the following Traffic Management Plans (TMP): See Drawings TMP-1, TMP-2.

The work zone must be left in a safe condition prior to workers and equipment leaving the work site. All excavations must be closed or protected.

RECOMMENDED: "ORIGINAL SIGNED BY" _____
Director, Traffic Engineering

APPROVED: "ORIGINAL SIGNED BY" _____
Executive Director
Highway Engineering

Traffic Control Device: **Work Zone**

Date of Revision: **March 15, 2002**

Division:

Subject: **Shoulder Work**

Page **1 of 1**

Purpose

When work activities are restricted to the shoulder of the road, the disruption to traffic flow may be decreased, but the motorist requires advance warning that men and equipment are in a position to be a potential hazard.

Protection of the travelling public and the safety of workers is paramount. However, these must be weighed against the cost and time involved with the installation and removal of the necessary traffic control devices.

Policy

Where work is being done on any Provincial Trunk Highway or Provincial Road on the shoulder of the road or in the median of a divided road, a minimum level of traffic control must be established and maintained for the duration of the time that workers or equipment are present.

Standard

Traffic control must consist of at least the minimum installation as described in the following Traffic Management Plans (TMP):

TMP-2
TMP-3
TMP-4
TMP-5
TMP-6
TMP-7
TMP-7A
TMP-8

RECOMMENDED: "ORIGINAL SIGNED BY"
Director, Traffic Engineering

APPROVED: "ORIGINAL SIGNED BY"
Executive Director
Highway Engineering

Traffic Control Device: **Work Zone**

Date of Revision: **June 26, 2007**

Division:

Subject: **Bridge Inspection**

Page **1 of 2**

Purpose

Bridge and culvert inspection activities causing disruption to traffic flow may be similar to work on the surface of the road, or off the road. A work zone located on the surface of a bridge may create an extraordinary hazard to workers and to the travelling public as the confined spaces of the bridge eliminate any possible escape routes. The motorist, however, may not typically require enhanced warning of potential hazards.

Protection of the travelling public and the safety of workers is paramount. However, these must be weighed against the cost and time involved with the installation and removal of the necessary traffic control devices.

Policy

Where routine inspections are being done on the surface of any bridge on any Provincial Trunk Highway or Provincial Road, a minimum level of traffic control must be established and maintained for the duration of the time that workers or equipment are present. Standard traffic management plans are sufficient in most situations. Where unusual conditions are anticipated, preplanning and discussions with the Traffic Operations Engineer are required.

Standard

Traffic control must consist of at least the minimum installation as described in the appropriate Traffic Management Plans (TMP). The following table will provide additional guidelines for the implementation of traffic control on bridge inspection projects. Additional enhancements may be considered when traffic conditions warrant.

RECOMMENDED: "ORIGINAL SIGNED BY"
Director, Traffic Engineering

APPROVED: "ORIGINAL SIGNED BY"
Executive Director
Highway Engineering

BRIDGE INSPECTION TRAFFIC CONTROL

ROAD TYPE	TRAFFIC VOLUME (VEH/HR)	BRIDGE OR CULVERT	REQUIRED TRAFFIC MANAGEMENT PLAN	MODIFICATIONS TO EXISTING TMP'S TO SUIT BRIDGE INSPECTIONS
LEVEL 1				
All Roads	All	All	TMP 1	None required
LEVEL 2				
Two Lane Road	< 60	C	TMP 1	None required
		B	TMP 3	Install signs in both directions
	> 60	C	TMP 3	Install signs in both directions
		B	TMP 6	Install signs in both directions, cones not required
Multi-Lane Road	All	C	TMP 4	None required
		B	TMP4	Also install MR-96
LEVEL 3				
All Roads	All	All	as required	As required
UNDERBRIDGE				
Two Lane Road	< 60	All	TMP 12	Also install MC-6 and MR-96, all signs installed in both directions. Use one flagperson only
	> 60	All	TMP 12	Also install MC-6 and MR-96, all signs installed in both directions
Multi-Lane Road	All	All	TMP 13	None required

INSPECTION TYPE

DEFINITIONS

Bridge Any bridge or culvert structure
 TMP Traffic Management Plan as defined in the Work Zone Traffic Control Manual
 B Bridge structure
 C Culvert structure

INSPECTION TYPES

Level 1 Maintenance inspections
 Level 2 Detailed visual inspections
 Level 3 Condition assessment inspections
 Underbridge Inspections using the underbridge crane unit

SIGN DESCRIPTIONS

MC-6 One Lane Traffic
 MR-96 Maximum 60 When Passing Workers
 WA-33R/L Right/Left Lane Cutoff
 TC-2 Men Working
 TC-21 Flagman Ahead
 C-44 Flagperson Paddle

SIGN SEQUENCES (EXTENDING OUT FROM WORK AREA)

TMP 1 none
 TMP 3 TC-2
 TMP 4 MR-96x2; TC-2x2
 TMP 6 MR-96; TC-2
 TMP 12 Class 'B'; TC-21; MR-96; TC-2
 TMP 13 sequencer; MR-96; WA-33R/L; TC-2

Traffic Control Device: **Work Zone**

Date of Revision: **March 15, 2002**

Division:

Subject: **Mobile Operations**

Page **1 of 2**

Purpose

Mobile operations present a special set of traffic control problems.

Protection of the travelling public, and the safety of workers is paramount. However, these must be weighed against the cost and time involved with the installation and removal of the necessary traffic control devices.

The speed of the operation and the duration at any one work location makes the signing of the work site using standard techniques difficult and hard to justify from a cost perspective. However, safety of the motorist and workers requires that some form of advance warning be provided and maintained.

Definition

Mobile Operations - Include any operation where the maximum duration of any activity on or near the road surface is less than 5 minutes for any 30 m length of work zone. Mobile operations include maintenance activities which are of very short duration, including "Pitch and Run", "Sign Washing", and any other activity where workers are exposed to traffic for short periods of time.

Policy

Whenever a construction and maintenance activity can be identified as a mobile operation, a minimum level of traffic control must be established and maintained for the duration of the work. This policy/standard is limited to "daylight hours" only.

Whenever mobile operations must occur during hours of darkness, a Traffic Management Plan (TMP) must be approved by the Director of Traffic Engineering or designate.

RECOMMENDED: "ORIGINAL SIGNED BY" _____
Director, Traffic Engineering

APPROVED: "ORIGINAL SIGNED BY" _____
Executive Director
Highway Engineering

Standard

Traffic control must consist of one of the following drawings: TMP-5, TMP-9, TMP-10

- A buffer vehicle located a distance from the work zone (distance determined by travelling speeds). The buffer vehicle must be equipped with warning lights and rear facing sign, **or on four-lane roads only**, a sequential flasher indicating required motorist action. In situations with limited sight distance the buffer vehicle should remain at the most visible location available. In extreme cases, such as restricted visibility conditions, or during high traffic flows, the work should be rescheduled. Where this is not possible, a TMP approved by the Director of Traffic Engineering or designate must be implemented and maintained.
- A ROAD WORKS sign (TC-2) which must be located within sight of the work zone, is required when traffic flow levels during the periods of work are greater than **60 vehicles per hour**.

Traffic Control Device: **Work Zone**

Date of Revision: **March 15, 2002**

Division:

Subject: **Fast Moving Operations -
Benkelman Beam (Pavement Deflection)**

Page **1 of 2**

Purpose

Fast moving operations present a special set of traffic control problems.

Protection of the travelling public, and the safety of workers is paramount. However, these must be weighed against the cost and time involved with installing and removing the necessary traffic control devices.

The lateral position of the flagperson, i.e. distance away from the relative safety of the shoulder, also must weigh personal safety against the flagperson's ability to adequately control and warn traffic.

Definition

Fast Moving Operations will generally be considered to include any operation which stops on the travelled surface of the road for a period not exceeding 10 minutes in daylight hours only.

This standard covers Benkelman beam (pavement deflection) only. Due to variations in their operations, other fast moving operations such as B-30 soil drill truck, nuclear density testing, coring unit, profilometer and "hi-lo" measurements have similar complimentary standards.

Policy

This standard covers the self-propelled Benkelman beam operation only. Due to the continuous mobile nature of this operation, static advance signing is not feasible. Vehicle and equipment mounted signs and lights must provide adequate warning.

This policy applies to all Provincial Trunk Highways and Provincial Roads.

Standard

Traffic control should consist of at least the following (see drawing S-TMP-1):

- Symbolic FLAGMAN sign (TC-21) or rectangular fluorescent orange warning sign FREQUENT STOPS mounted on rear of trailing flagman's vehicle (1/2 ton or van).

RECOMMENDED: "ORIGINAL SIGNED BY"
Director, Traffic Engineering

APPROVED: "ORIGINAL SIGNED BY"
Executive Director
Highway Engineering

- Flagpersons stationed **in the closed lane**, approximately 1 m from roadway centreline, **at the front of the flagperson's vehicle** (no closer than 15 m to the vehicle) to allow a clear "escape route" for the flagperson, and to provide refuge from a possible errant vehicle.
- Five-ton "deflection unit" vehicle with the following warning devices operating: front and rear facing "wig-wag" amber flashers, high beam headlamps, and four-way flashers.
- A rectangular fluorescent orange warning sign FREQUENT STOPS and fluorescent orange/black hazard marker signs should be mounted on the rear of the five-ton deflection unit. (Signs should be removed or covered during travel to and from the highway under measurement.)
- The five-ton deflection unit vehicle is required to be parked in the closed lane during pavement deflection measurements.
- Flagperson must be in position **before** Benkelman beam operator proceeds onto roadway surface.
- For urban areas with speed limits under 60 km/h, traffic controls may be compressed to 50 m overall (sign to deflection unit vehicle). Additional care should be exercised to ensure accesses from driveways, etc. are considered.

Traffic Control Device: **Work Zone**

Date of Revision: **March 15, 2002**

Division:

Subject: **Fast Moving Operations-Soil Drill Truck/Coring Operations** Page 1 of 2

Purpose

Fast moving operations present a special set of traffic control problems.

Protection of the travelling public, and the safety of workers is paramount. However, these must be weighed against the costs and time involved with installing and removing the necessary traffic control devices.

The lateral position of the flagperson, i.e. distance away from the relative safety of the shoulder, also must weigh personal safety against the flagperson's ability to adequately control and warn traffic.

Definition

Fast Moving Operations will generally be considered to include any operation which stops on the travelled surface of the road for a period not exceeding 10 minutes in daylight hours only.

This standard covers B-30 soil drill truck and coring vehicle operations only. Due to variations in their operations, other fast moving operations such as nuclear density testing, Benkelman beam testing and "hi-lo" measurements have similar complimentary standards.

Policy

This standard covers the B-30 soils drill truck and coring vehicle operations only. Due to the continuous mobile nature of this operation, static advance signing is not feasible. Vehicle and equipment mounted signs and lights must provide adequate warning.

This policy applies to all Provincial Trunk Highways and Provincial Roads.

RECOMMENDED: "ORIGINAL SIGNED BY" _____
Director, Traffic Engineering

APPROVED: "ORIGINAL SIGNED BY" _____
Executive Director
Highway Engineering

Standard

Traffic control shall consist of at least the following (see drawing S-TMP-2):

- Symbolic Flagman sign (TC-21) on portable sign stand or sign trailer.
- Flagperson stationed in the closed lane, approximately 1 m from roadway centreline.
- Symbolic Road Work sign (TC-2) on two-way roadways for traffic in opposite direction.
- Ten traffic cones; 5 required for tapered lane closure, 5 recommended on tangent as shown on S-TMP-2.
- When required, the technicians truck shall park on the shoulder behind the soil drill truck/coring vehicle. This vehicle shall have a rotating beacon operating.
- The drill truck/coring unit is to be parked in the closed lane.
- Signs shall be supplemented by fluorescent red flags. Flags are also highly desirable on the soils drill truck/coring unit.
- This is a minimum standard. Where traffic volumes or sight restrictions create a problem, a second Flagman sign and a second flagperson for traffic in the opposite direction will be required on two-way roadways. The distance to the flagperson and sign will be 70 m and 150 m respectively, from the soils drill truck.
- For urban areas with speed limits under 60 km/h, traffic controls may be compressed to 50 m overall (sign to soil drill truck/coring unit). Additional care should be exercised to ensure accesses from driveways, etc. are considered.

Purpose

Fast moving operations present a special set of traffic control problems.

Protection of the travelling public, and the safety of workers is paramount. Every reasonable effort must be taken to enhance the visibility of slow-moving equipment where its unexpected presence and slow speed may otherwise demand drastic avoidance manoeuvres by highway traffic.

Definition

Fast Moving Operations will generally be considered to include any operation which travels continuously or stops on the travelled surface of the road for a period not exceeding 10 minutes in daylight hours only.

Policy

This standard covers the self-propelled profilograph unit only. Due to the continuous mobile nature of this operation, static advance signing is not feasible. Vehicle and equipment mounted signs and lights must provide adequate warning.

This policy applies to all Provincial Trunk Highways and Provincial Roads.

Standard

- The profilograph operation effectively closes the lane being evaluated/measured. Traffic must find its way around the operation on two-lane two-way (2L2W) highways by choosing appropriate available gaps in the oncoming traffic stream.
- For traffic safety reasons the profilograph unit must restrict its operation to daylight hours only. Late season operation must be evaluated to determine that low sunlight angles do not obscure equipment visibility.

Traffic control shall consist of at least the following (see drawing S-TMP-3):

- A trailing vehicle comprising a suitable vehicle towing the profilograph trailer, following approximately 15 m behind the self propelled profilograph unit and equipped with the following:
 - a special black on fluorescent reflective orange rearward facing hinged sign “Yield To Approaching Traffic”
 - highly visible black/fluorescent orange diagonal cross-hatched markings on the back of the trailer unit
 - extremely bright flashing yellow strobe lights (Whelen model 97 or equivalent) facing front and rear, mounted as high as possible on the trailing vehicle trailer
 - a rear-facing sequential flashing "arrow board" - the arrow board should flash in the non-directional "diamond" or four-corner mode during operation on 2L2W roadways, and indicate the direction for following traffic to pass (left or right as applicable) only on multi-lane roadways
 - fluorescent orange flags (in specially constructed flagholders) at the rear of the trailing vehicle trailer unit
 - headlights and forward facing strobe lights on the profilograph tractor unit (similar to those on the trailing vehicle trailer)
 - fluorescent orange pennant mounted at the front and rear of the profilograph beam
- Where traffic volumes, highway geometry, or other conditions dictate, (and the operation cannot reasonably be rescheduled), an additional **trailing vehicle** may be necessary. This vehicle operating **on the shoulder** should be equipped with flashing or rotating amber warning lights, a special black-on-fluorescent orange sign SLOW MOVING EQUIPMENT AHEAD (see sketch), and should follow the first trailing vehicle at a distance of approximately 300 m.
- As with other fast moving operations, profilograph operators must continually evaluate traffic conditions and be prepared to discontinue operations to allow following traffic queues to pass, or to abandon operations until conditions improve.

Traffic Control Device: **Work Zone**

Date of Revision: **March 15, 2002**

Division:

Subject: **Fast Moving Operations/Nuclear Density Testing**

Page **1 of 3**

Purpose

Fast moving operations present a special set of traffic control problems.

Protection of the travelling public, and the safety of workers is paramount. However, these must be weighed against the cost and time involved with installing and removing the necessary traffic control devices.

The lateral position of the flagperson, i.e. distance away from the relative safety of the shoulder, also must weigh personal safety against the flagperson's ability to adequately control and warn traffic.

Definition

Fast Moving Operations will generally be considered to include any operation which stops on the travelled surface of the road for a period not exceeding 10 minutes in daylight hours only.

This standard covers nuclear density testing only. Due to variations in their operations, other fast moving operations such as B-30 soil drill truck, coring unit, Benkelman beam testing, profilometer, and "hi-lo" measurements have similar complementary standards.

Policy

This standard covers nuclear density testing only. Due to the continuous mobile nature of this operation, static advance signing is not feasible. Vehicle and equipment mounted signs and lights must provide adequate warning.

This policy applies to all Provincial Trunk Highways and Provincial Roads and all surfacing and grading projects open to traffic.

RECOMMENDED: "ORIGINAL SIGNED BY" _____
Director, Traffic Engineering

APPROVED: "ORIGINAL SIGNED BY" _____
Executive Director
Highway Engineering

Traffic control should consist of at least the following (see drawing S-TMP-4):

- Symbolic FLAGMAN sign (TC-21) on portable sign stand, sign trailer or shadow vehicle.
- Flagperson stationed **in the closed lane**, approximately 1 m from roadway centerline.
- Ten traffic cones; 5 **required** for tapered lane closure, 5 **recommended** on tangent as shown on S-TMP-4.
- Density inspector's vehicle equipped with the following warning devices: approved rotating beacon or strobe, rear-facing "wig-wag" amber flashers, **and headlights on high beam**. If headlights and "wig-wag" amber flashers are operating, use of rotating beacon or strobe is optional.

The density inspector's vehicle is to be parked in the closed lane. The density inspector's vehicle must be capable of carrying all signs, lights and cones required to create the work zone as per the standard.

- Signs must be supplemented by fluorescent red flags. Flags are also highly desirable on the density inspector's vehicle.
- This is a minimum standard. Where traffic volumes or sight restrictions create a problem, a second sign and a second flagperson for traffic in the opposite direction will be required on two-way roadways. The distance to the flagperson and sign will be 70 m and 150 m respectively, from the density inspector's vehicle.
- Visibility (to the motorist) of the nuclear density testing operation is an ongoing problem. Extra care must be taken to ensure that all traffic control devices are in good condition, clean, and placed properly. All warning lights must be clean and operating effectively. All workers must be attired in clean, highly visible department approved safety vest and head wear.
- The flagperson may be located up to 500 m from the symbolic FLAGMAN AHEAD sign **only where the flagperson is visible from the sign location, and no major accesses or intersections exist in the area between sign and flagperson**.
- For urban areas with speed limits under 60 km/h, traffic controls may be compressed to 50 m overall (sign to density inspector's vehicle). In certain circumstances, i.e. parallel or diagonal parking, sign use may be impractical. Accesses from driveways, etc. may have to be taken into consideration in determining locations of cones and flagpersons. (Crews are expected to base their decisions regarding sign use in urban areas, on experience and common sense to ensure worker and public safety is not compromised.)

- Where a shadow vehicle is used (recommended on high volume two-lane roadways) the shadow vehicle should be located half on the shoulder, half on the travel lane. The shadow vehicle must be equipped with rear-facing "wig wag" amber flashers. The flagman ahead sign must be mounted on the right hand rear of the shadow vehicle

Traffic Control Device: **Work Zone**

Date of Revision: **March 15, 2002**

Division:

Subject: **Fast Moving Operations – Hi-Low Vehicle**

Page **1 of 2**

Purpose

Fast moving operations present a special set of traffic control problems.

Protection of the travelling public, and the safety of workers is paramount. Every reasonable effort must be taken to enhance the visibility of slow-moving equipment where its unexpected presence and slow speed may otherwise demand drastic avoidance manoeuvres by highway traffic.

Definition

Fast Moving Operations will generally be considered to include any operation which travels continuously or stops on the travelled surface of the road for a period not exceeding 10 minutes in daylight hours only.

Policy

This standard covers the Hi-Low Vehicle only. Due to the continuous mobile nature of this operation, static advance signing is not feasible. Vehicle mounted signs and lights must provide adequate warning.

This policy applies to all Provincial Trunk Highways and Provincial Roads.

Standard

- The Hi-Low operation effectively closes the lane being evaluated/measured. Traffic must find its way around the operation on two-lane two-way (2L2W) highways by choosing appropriate available gaps in the oncoming traffic stream.
- For traffic safety reasons the Hi-Low vehicle must restrict its operation to daylight hours only. Late season operation must be evaluated to determine that low sunlight angles do not obscure equipment visibility.

RECOMMENDED: "ORIGINAL SIGNED BY" _____
Director, Traffic Engineering

APPROVED: "ORIGINAL SIGNED BY" _____
Executive Director
Highway Engineering

Traffic control shall consist of at least the following (see drawing S-TMP-5):

- A Hi-Low Vehicle equipped with the following:
 - a black on fluorescent reflective orange rearward facing sign PASS WITH CARE
 - extremely bright flashing yellow strobe light (Whelen model 97 or equivalent) facing front and rear,
 - a rear-facing sequential flashing arrow board - the arrow board should flash in the non-directional “diamond” or four-corner mode during operation on 2L2W roadways, and indicate the direction for following traffic to pass (left or right as applicable) only on multi-lane roadways
 - fluorescent orange flags at the front and rear of the Hi-Low vehicle
- As with other fast moving operations, Hi-Low vehicles must continually evaluate traffic conditions and be prepared to discontinue operations to allow following traffic queues to pass, or to abandon operations until conditions improve.

Purpose

Fast moving operations present a special set of traffic control problems.

Protection of the travelling public, and the safety of workers is paramount. Every reasonable effort must be taken to enhance the visibility of slow-moving equipment where its unexpected presence and slow speed may otherwise demand drastic avoidance manoeuvres by highway traffic.

Definition

Fast Moving Operations will generally be considered to include any operation which travels continuously or stops on the travelled surface of the road for a period not exceeding 10 minutes in daylight hours only.

Policy

This standard covers the self-propelled Asphaltite unit only.

This policy applies to all Provincial Trunk Highways and Provincial Roads.

Standard

- The Asphaltite operation effectively closes the lane being worked on. Traffic must find its way around the operation on two-lane two-way (2L2W) highways by choosing appropriate available gaps in the oncoming traffic stream.
- For traffic safety reasons the Asphaltite unit must restrict its operation to daylight hours only. Late season operation must also be evaluated to determine that low sunlight angles do not obscure equipment visibility.

Traffic control shall consist of at least the following (see drawing S-TMP-7):

- A trailing vehicle, following approximately 40 m behind the self propelled Asphaltite unit and equipped with the following:
 - a special black on reflective white rearward facing sign PASS WITH CARE.
 - rotating beacon, mounted as high as possible
- A rear-facing sequential flashing "arrow board" must be equipped on either the Asphaltite unit or the trailing vehicle. The arrow board should flash in the non-directional "diamond" or four-corner mode during operation on 2L2W roadways, and indicate the direction for following traffic to pass (left or right as applicable) only on multi-lane roadways.
- The Asphaltite unit must operate with rotating beacon and headlights on high beam.
- Flying Stones signs (MW-94) should be installed, spaced not more than 5 km apart facing both directions of traffic and shall be left in place for a period of at least 24 hours after work is completed, or longer as required.
- As with other fast moving operations, Asphaltite operators must continually evaluate traffic and visibility conditions and be prepared to discontinue operations to allow following traffic queues to pass, or to abandon operations until conditions improve.
- When working in low-speed urban areas or low volume rural areas, the trailing vehicle is recommended but not required, provided the Asphaltite unit is equipped with a flashing arrow board.

Purpose

Mobile operations present a special set of traffic control.

Protection of the travelling public and the safety of workers is paramount. However, these must be weighed against the cost and time involved with the installation and removal of the necessary traffic control devices.

The speed of the operation and the duration at any one work location makes the signing of the work site using standard techniques difficult and hard to justify from a cost perspective. However, safety of the motorist and workers requires that some form of advance warning be provided and maintained.

Definition

Mobile Operations - Include any operation where the maximum duration of any activity on or near the road surface is less than 5 minutes for any 30 m length of work zone. Mobile operations include maintenance activities which are of very short duration, including "Pitch and Run", "Sign Washing", and any other activity where workers are exposed to traffic for short periods of time.

Policy

This standard covers the maintenance gravelling of gravel roads. This policy/standard is limited to "daylight hours" only.

Standard

Traffic control must consist of the following (see drawing S-TMP-8):

- ROAD WORKS signs (TC-2) or “Truck Graveling” sign placed at both ends of the work zone.
- The Work Zone length must not be greater than 10 km.
- All “gravel trucks” must have headlights on when graveling.

Purpose

Traffic control during signal maintenance, construction and repair is necessary to ensure the safety of all motorists, pedestrians and workers.

Policy

This policy applies to all intersections where traffic signals will be temporarily inoperative or where signal displays may be blocked or otherwise affected by the work in progress, or motorists may be distracted or confused by the presence of workers or signal vehicles.

Standard

The following standards are applicable to planned traffic signal maintenance, construction and repairs:

1. For **all** planned work except minor inspections or non-intrusive activities such as controller adjustments, the TC-2 (Men Working) sign should be placed on all affected approaches (refer to S-TMP-3 and S-TMP-4).

For urban areas where signing on the right hand side may be obscured by parked vehicles, signs may be more effective if placed in the median of a divided street or roadway.

2. For all planned work where traffic signals will be temporarily inoperative (i.e. cutovers, controller replacement, etc.), the TC-2 (men working sign) and MW-121 (signals under repair ahead sign) should be placed on all approaches (refer to S-TMP-9 and S-TMP-10).
3. Additional traffic control for planned traffic signal repairs with signals inoperative should be as follows:
 - For lower speed (<70 km/h) – Lower Volume intersections (i.e. Gimli, Dauphin, The Pas) (refer to S-TMP-9): Traffic should normally be controlled with 4-way stop signs with advance stop ahead signs. The signal crew should be mindful and watchful of traffic and pedestrians, and if necessary, aid pedestrians who wish to cross the roadway.

- Low Speed-High Volume on Main Road, Low Volume on cross road intersections (i.e. PTH 9 at Riverglenn, 1st/Rosser (Brandon), etc.) (refer to S-TMP-10): Traffic would normally be controlled with 2-way stop signs, flagman ahead signs and Department flagpeople.
- Low Speed-High Volume on all approaches (i.e. Richmond/18th Street, 18th Street/Park, etc.) (refer to S-TMP-10): Traffic would normally be controlled with 2-way stop signs, flagman ahead signs and Police (City or RCMP).
- High Speed-High Volume (i.e. 100/St. Mary's, 1/16, etc.) (refer to S-TMP-10): Traffic would normally be controlled with 2-way stop signs, flagman ahead signs and Police (City or RCMP).
- High Speed-Lower Volume (i.e. 1/Blumberg, 1/Odeon, etc.): To be reviewed and approved by the Traffic Operations Engineer on a site-by-site basis.

Traffic Control Device: **Work Zone**

Division:

Subject: **Fast Moving Operation – Pavement Marking**

Page **1** of **2**

Purpose

Fast moving operations present a special set of traffic control problems.

Protection of the travelling public and the safety of workers is paramount. Every reasonable effort must be taken to enhance the visibility of slow-moving equipment where its unexpected presence and slow speed may otherwise demand avoidance manoeuvres by highway traffic.

Definition

Fast Moving Operations will generally be considered to include any operation which travels continuously or stops on the travelled surface of the road for a period not exceeding 10 minutes in daylight hours only.

Policy

This standard covers the pavement marking truck and paint supply truck only. Due to the continuous mobile nature of this operation, static advance signing is not feasible. Vehicle and equipment mounted signs and lights must provide adequate warning.

This policy applies to all Provincial Trunk Highways and Provincial Roads.

Standard

Traffic control should consist of at least the following (see drawings S-TMP-11 and S-TMP-12):

- A trailing vehicle, following approximately 400 m behind the pavement marking vehicle and equipped with the following:
 - A rearward facing “ WET PAINT” sign
 - Rotating beacon
 - Rear-facing sequential flashing arrow

RECOMMENDED: “ORIGINAL SIGNED BY”
Director, Traffic Engineering

APPROVED: “ORIGINAL SIGNED BY”
Executive Director
Highway Engineering

- Pavement Marking Vehicle equipped with the following warning devices:
 - Rotating beacon
 - Front and rear-facing warning lights
 - Rear-facing “Pass With Care” sign
 - Optional - rear-facing sequential flashing arrow

- Paint Supply / Sweeper Vehicle operating 1-5 km in front of the Pavement Marking Vehicle equipped with the following warning devices:
 - Rotating beacon
 - Front and rear-facing warning lights

Traffic Control Device: **Work Zone**

Date of Revision: **February 28, 2006**

Division:

Subject: **Sealcoat Operations**

Page **1 of 2**

Purpose

Sealcoat operations present a special set of traffic control problems.

Protection of the travelling public and the safety of workers is paramount. However, these must be weighed against the cost and time involved with installing and removing the necessary traffic control devices.

Sealcoat projects are unique in that vehicles are at a greater risk of damage by stones from passing vehicles than would normally be expected on a surfaced roadway. Most drivers are unaware of the details of sealcoat operations and must be given additional information to ensure they are aware of the potential hazards.

Policy

This standard covers the sealcoat operation only.

Prior to commencing a sealcoat operation over a paved surface, the start and end of all passing restrictions must be signed using the "No Passing" (RB-31) sign and the "Passing Permitted" (RB-32) sign.

- Windshield Hazard signs (MW-94) should be installed at the beginning of all sealcoat projects over 3 km in length. Windshield Hazard signs are normally not required where the sealcoat work is being done as part of a large construction project where project boards and gates are in place.

Traffic control should consist of at least the following in addition to standard work-zone signing(see drawing TMP-29):

- Symbolic "Flying Stones" sign (MW-94), "No Passing" sign (RB-31) and **regulatory** "Maximum 40 When Meeting Traffic" sign (MR-136) repeated at minimum 3 km intervals throughout the length of the project. These signs should be maintained as necessary during and immediately after the sealcoating operation until the "flying stones" hazard has been minimized.
- Flagperson stationed at each end of the active work area where sealcoating is in progress.

RECOMMENDED: "ORIGINAL SIGNED BY"
Director, Traffic Engineering

APPROVED: "ORIGINAL SIGNED BY"
Executive Director
Highway Engineering

- Optional Pilot Vehicle and additional flagpeople, as required, based on traffic volume and road geometry. See Policy/Standard 900-C-8 for Pilot Vehicle Traffic Control.
- Portable radar-based Speed Reader Boards may be used at both ends of all rural sealcoat operations when the “flying stone” hazard is present, to provide motorists with additional travel speed reminders. Reader Board use should also be considered on an as-required basis for urban sealcoat operations.

Traffic Control Device: **Work Zone**

Date of Revision: **March 15, 2002**

Division:

Subject: **Short Term Lane Closures**

Page **1 of 1**

Purpose

Protection of the travelling public and the safety of workers is paramount. However, these must be weighed against the cost and time involved with the installation and removal of the necessary traffic control devices.

Short term lane closures are required to allow workers to accomplish their activities in a safe and efficient manner. These lane closures must be installed whenever work activities disrupt the normal flow of traffic.

Definition

Short Term means a lane closure that is installed and removed on the same day, and is applicable during daylight periods only.

Policy

Whenever construction and maintenance activities disrupt the normal flow of traffic on Provincial Trunk Highways or Provincial Roads, or cause workers or motorists to be in a hazardous situation on these roads, a Traffic Management Plan (TMP) must be developed, installed, and maintained for the duration of the disruption or condition. When the condition will be returned to normal during one daylight period "short term" traffic control methods may be used.

Standard

Traffic control should consist of one of the following Traffic Management Plans:

- TMP-11 - Two-Lane Road - Yield to Oncoming Traffic (<60 vehicles per hour)
- TMP-12 - Single Lane Closed on Two-Lane Road (Volume > 60 vehicles per hour)
- TMP-13 - Right Lane Closed on Four-Lane Divided Road
- TMP-14 - Left Lane Closed on Four-Lane Divided Road

RECOMMENDED: "ORIGINAL SIGNED BY"
Director, Traffic Engineering

APPROVED: "ORIGINAL SIGNED BY"
Executive Director
Highway Engineering

Traffic Control Device: **Work Zone**

Date of Revision: **March 15, 2002**

Division:

Subject: **Daylight Detour – Flagpersons Required Continuously** Page 1 of 2

Purpose

Short term detours present a special set of traffic control problems.

Protection of the travelling public, and the safety of workers is paramount. However, these must be weighed against the cost and time involved with installing and removing the necessary traffic control devices.

Flagpersons, used effectively, can be expected to substitute for some other traffic control devices. However, heavy traffic volumes, limited sight distances, or poor visibility conditions may require additional measures to ensure motorist and worker safety.

Definition

Daylight detours will be considered to include any shoo-fly (minor deviation) type of detour which will be in place for daylight hours only.

Policy

Whenever a construction and maintenance activity or other situation causes the requirement for a “daylight hours” only detour to be required the following special Traffic Management Plan (TMP) must be implemented and maintained. This policy applies to all Provincial Trunk Highways and Provincial Roads and during daylight hours only.

Standard

Traffic control should consist of at least the following (see drawing TMP-23):

- DETOUR AHEAD (TC-10) and FLAGMAN AHEAD (TC-21) signs placed as shown for traffic in both directions.
- Signs mounted as shown. (Department approved portable sign stands acceptable.)

RECOMMENDED: “ORIGINAL SIGNED BY”
Director, Traffic Engineering

APPROVED: “ORIGINAL SIGNED BY”
Executive Director
Highway Engineering

- Two flagpersons, (properly attired), one for traffic in each direction. Flagpersons should be in radio (preferred) or visual contact, and should allow traffic to proceed from one direction at a time. Refer to Policy/Standard 900-B-2 "Flagpersons".
- Class A "directional" barricades required in the closed lanes for traffic in both directions.
- Class B barricades **recommended where space is available**.
- Reflectorized orange delineator posts (50 mm x 1200 mm) at 15 m spacing, placed on left and right side of detour.

NOTE: Project Supervisors must assess each situation **individually**; based on experience and good judgement implement additional measures as necessary to ensure the safety of motorists and workers.

Traffic Control Device: **Work Zone**

Date of Revision: **March 15, 2002**

Division: **Work Zone Traffic Management - Long Term**

Subject: **Traffic Diversion - Long Term**

Page **1 of 1**

Purpose

Protection of the travelling public, and the safety of workers is paramount. However, these must be weighed against the cost and time involved with the installation and removal of the necessary traffic control devices.

Long term traffic diversions are required when the nature of work activities extend the disruption of traffic beyond a single day. The traffic diversions are typically designed to a higher level than short term lane closures to limit the manpower required for flagging operations.

Definition

Long Term means a traffic diversion that is installed for any period through the hours of darkness.

Policy

Whenever a construction and maintenance activity or other situation causes the requirement for a traffic diversion that will extend beyond a single day (i.e. overnight or longer) a special Traffic Management Plan (TMP) must be designed, implemented, and maintained.

This policy applies to all Provincial Trunk Highways and Provincial Roads.

Standard

Traffic Control should consist of one of the following Traffic Management Plans:

- TMP-15 - Left Lane Drop - Four-Lane Divided Highway
- TMP-16 - Right Lane Drop - Four-Lane Divided Highway

RECOMMENDED: "ORIGINAL SIGNED BY" _____
Director, Traffic Engineering

APPROVED: "ORIGINAL SIGNED BY" _____
Executive Director
Highway Engineering

Traffic Control Device: **Work Zone**

Date of Revision: **March 15, 2002**

Division:

Subject: **Four Lane Divided Highway**

Page **1 of 2**

Conversion to Two-Lane Two-Way (2L2W) Operation

Purpose

Occasionally it is necessary to operate a four-lane divided highway as a two-lane two-way (2L2W) highway to accommodate construction or maintenance activities, or emergencies. However, these operations can be exceptionally dangerous, particularly over longer stretches of road where there is considerable risk of head-on collisions.

Policy

Before implementing any 2L2W operation the use of any adjacent service roads should be considered as an alternate route.

Because of the risks associated with 2L2W operation, the opposing traffic flows must be physically separated. The most desirable method of providing this separation is by the use of the portable concrete median barrier (CMB) or water filled plastic median barrier, supplemented by reflective delineators.

However, for projects of considerable length, short term projects, or where sufficient clear roadway width is not available (bridge decks, etc.), it may not be practical to utilize CMB's. Under these conditions other devices as noted may be used.

Standard

To prohibit passing on the 2L2W section, either flexible, highly visible fluorescent orange reflectorized marker posts at 10 m spacing, or portable concrete or plastic water-filled median barriers should be used to separate opposing traffic flows. These devices should be supplemented by barrier delineators or by a pair of yellow temporary overlay markers (TOM) at 10 m intervals when the orange marker posts are used. When CMB's are used, care must be taken to orient the end units such that the unprotected ends are not exposed to oncoming traffic.

RECOMMENDED: "ORIGINAL SIGNED BY" _____
Director, Traffic Engineering

APPROVED: "ORIGINAL SIGNED BY" _____
Executive Director
Highway Engineering

Under normal conditions it will be necessary to reduce the prevailing speed limit on the 2L2W section. Refer to Policy/Standard 900-C-6. In addition, speed reductions (advisory or regulatory) may be necessary through the crossover areas. (For an example see drawing TMP-25)

At least one set of DO NOT PASS (RB-31) and TWO WAY TRAFFIC (RB-24) signs should be installed. They should be repeated at a minimum interval of 1 km, in each direction when applicable, and following Provincial Trunk Highway or Provincial Road intersections.

A minimum clear lane width of 3.7 m including shoulders should normally be maintained at all times. Reduced widths may be approved by the Director of Traffic Engineering. However, special signing, and notification of the Road Information/Permits section will also be required for reduced widths.

The 2L2W section should be re-stripped with pavement markings of the appropriate colour and configuration. For this purpose either semi-permanent materials or paint may be used.

During winter months when 2L2W operations are in effect and markings are obliterated or obscured, every effort must be made to maintain the flexible orange marker posts.

All conversions to two-lane two-way operations require approval by Traffic Engineering Branch.

Purpose

Route detours should always be considered whenever a detour will provide the best service to through (as distinct from local) traffic. It may be necessary or desirable to allow local traffic on the "closed" roadway.

In many cases the route that is used to detour highway through traffic is under the jurisdiction of some other authority (municipality, town, local government district). Normally these roads are not used as through routes, particularly to the detour destination. In addition to the basic requirement of safely detouring traffic at the intersection(s) of the detour route and the highway, it is also necessary to provide directional guidance at appropriate intervals, and to control all intersections in a manner that protects the detoured traffic. Route detour notification including all closure information must be given to all affected stakeholders, i.e. rural municipalities, EMS, schools, and R.C.M.P.

Policy/Standard

Agreement must be reached between the local traffic authority and the Department regarding the authority to control intersections as required on the detour route. In general, all intersections along a detour route will be controlled with stop signs on either the east/west or north/south approach, favouring the detour route when feasible.

If either end of a route detour falls at a location that requires a construction gate assembly as specified in a contract, the gate assembly should be placed or moved so that it does not interfere with or detract from the barricade assemblies or signing required for the route detour. This may require that the construction gate assembly is located a considerable distance upstream from the barricade assembly or signing.

Detour highway route marker assemblies should be installed and maintained at all intersections where the detour route changes direction, and at other locations as required to maintain a maximum interval of 2 km between route markers.

ROUTE DETOUR SIGNING

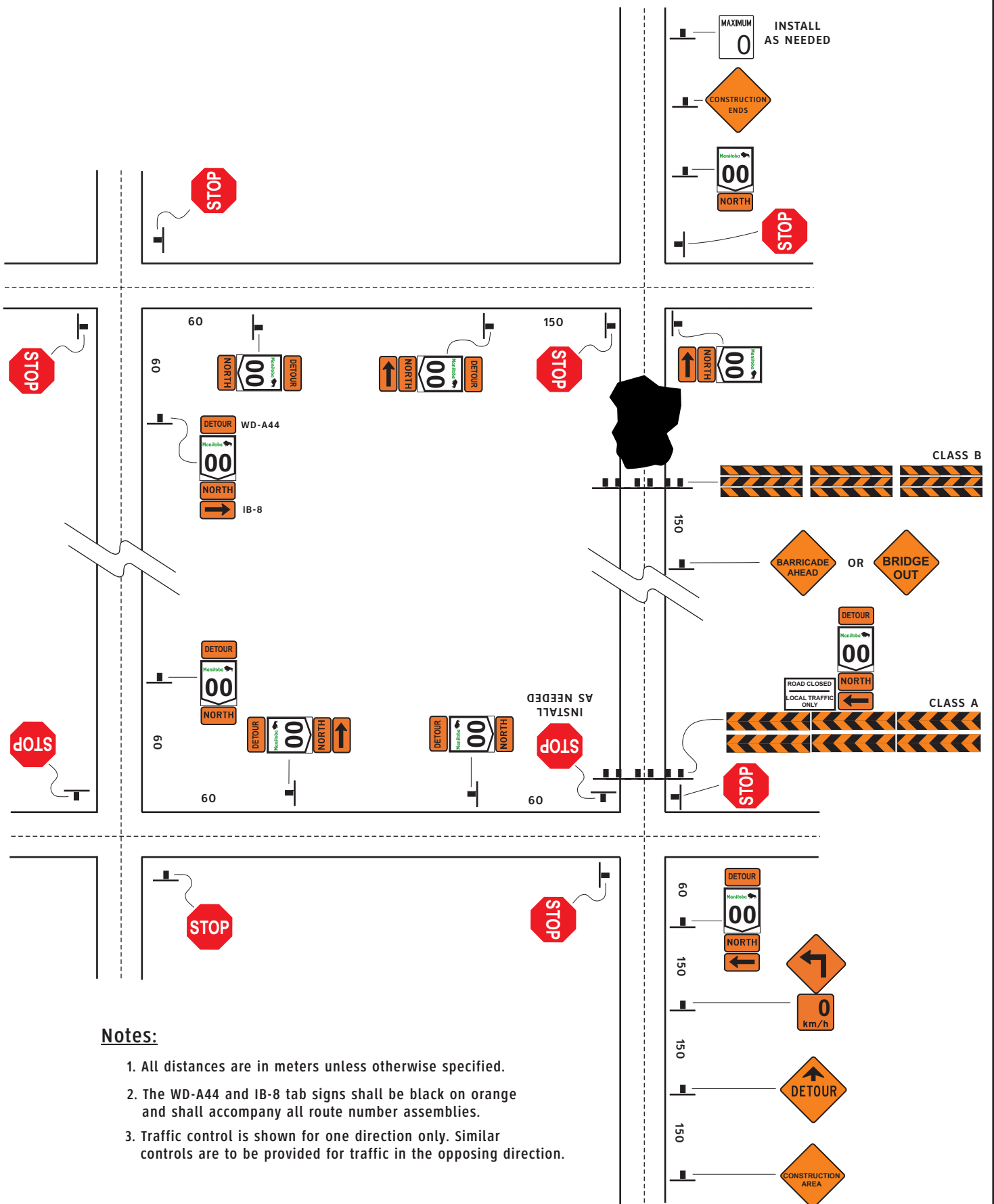

Notes:

1. All distances are in meters unless otherwise specified.
2. The WD-A44 and IB-8 tab signs shall be black on orange and shall accompany all route number assemblies.
3. Traffic control is shown for one direction only. Similar controls are to be provided for traffic in the opposing direction.

Traffic Control Device: **Work Zone**
Division: **Temporary Warning**
Subject: **Truck Entrance**

Purpose

Under some conditions it may be necessary or desirable to indicate the location where trucks are entering or crossing the main highway in order to minimize potential conflicts between high speed through traffic and slow moving trucks.

Policy

Orange symbolic TRUCK ENTRANCE signs (TC-54R) should be installed when **any one** of the following warranting conditions is met:

- An entering truck stopped at the entering roadway stop sign is not visible to approaching traffic on the main highway from **at least the stopping sight distance**. See Table 1.
- Chronic blowing dust or blowing snow on the main highway or haul road restricts the visibility of trucks to approaching traffic on the main highway. (Dust conditions should be treated where feasible with calcium chloride, water, etc. to alleviate this condition, and the continuance of truck haul operations closely monitored during dusty or snowy conditions to ensure that traffic safety is not compromised.)
- Trucks are entering a haul road reserved lane, typically as part of a four-lane divided highway, which is coned or delineated to separate it from the through traffic lane. Signs are not necessary if trucks do not cross or otherwise conflict with through traffic.
- A recorded incidence of entering truck/through traffic conflicts or collisions. Signs in this instance may be installed only with the approval of the Director of Traffic Engineering.

Note: Where feasible haul road approaches should be located/relocated with consideration to providing maximum approach visibility for highway traffic.

To limit the proliferation of unnecessary signs and to preserve the impact of necessary signs, **TRUCK ENTRANCE signs should only be installed where and when strictly warranted.**

RECOMMENDED: "ORIGINAL SIGNED BY" _____
Director, Traffic Engineering

APPROVED: "ORIGINAL SIGNED BY" _____
Executive Director
Highway Engineering

Standard

Signs should normally be located 150 m in advance of the crossing. Where necessary, due to extreme sight restrictions or approach geometry, **a second sign** up to 1 km in advance may be installed, and must include an appropriate orange distance tab xx m (WB-4T).

Signs must be removed or covered when the truck haul/truck entrance is not active, even if the truck entrance is in use for only part of the day. e.g. remove or cover signs at night if truck haul is daytime only.

Entering or crossing truck traffic must always be controlled by stop signs (or yield signs where a properly developed acceleration lane is in place for right-turning trucks).

When high traffic speeds and traffic volumes on the highway create problems or where it is not feasible for haul trucks to stop when approaching the main highway, due to steep approach gradient or extremely wet, soft grade, **traffic on the main highway must be controlled by flagmen and FLAGMAN AHEAD signs (TC-21), NOT TRUCK ENTRANCE signs.**

For truck hauls as part of a construction project, whether or not TRUCK ENTRANCE signs are warranted, Project Supervisors should point out to contractors that **truck drivers and other vehicle and equipment operators must obey all rules of the road, entering or crossing the main highway after stopping and only when this can be done safely and with minimum impact to the general highway user.**

Where TRUCK ENTRANCE signs are warranted, the appropriate right facing or left facing version of the sign should be installed to indicate to traffic on the main route the direction of approach of the entering trucks.

TABLE 1 - Minimum Stopping Sight Distance (SSD), Level Road ¹

Operating Speed ² (km/h)	SSD ³ (m)
60	85
70	100
80	140
90	170
100	200
110	220

1. contact Traffic Engineering Branch for approach downgrade SSD

2. where 85th percentile speed is unknown use posted speed limit plus 10 km/h

3. from the (RTAC) (TAC) *Geometric Design Guide for Canadian Roads*, 1999

Traffic Control Device: **Work Zone**

Date of Revision: **March 15, 2002**

Division: **Temporary Warning**

Subject: **Traffic Control at New 4-Lane Divided Highways
(Signing and Marking of Major Intersections)**

Page **1** of **2**

Purpose

To limit the probability of wrong way movements on **newly opened** rural sections of 4-lane divided highways by enhancing some intersection traffic controls.

Policy

Intersection Traffic Controls on newly opened sections of rural 4-lane divided highways should be enhanced for a short time following opening of the new facility. This should include all PTH, PR, and higher volume (500 + AADT) municipal road intersections.

Standard

- Two temporary, yellow symbolic DIVIDED HIGHWAY AHEAD warning signs (WA-34) with verbal DIVIDED HIGHWAY tabs should be installed, where feasible, at approximately 200 in advance of the stop sign for a minimum three month period. These signs should be enhanced by **permanent** reflectorized fluorescent orange metal flags.
- Temporary pavement arrows should be placed at the throat of the intersection.
- Pavement lane lines should be extended as far as possible into the intersection.
- Permanent WRONG-WAY signs should be enhanced by the installation of temporary reflectorized fluorescent orange metal flags, which should be removed after a three month period. These flags should not remain permanently but may be retained for up to 6 months depending on the continued occurrence of wrong-way movements.
- **Continuous flagging operations** at primary intersections should be provided for the first 24 to 48 hours following opening, and daytime flagging for the next 2 days, extended or reduced depending on the incidence of observed wrong-way movements, entering traffic volumes, and the nature of the entering traffic (local, commuter, recreational, long distance, etc.).
- All standard 4-lane intersection signing should be in place. Refer to Policy Standard 100-C-12 for wrong way signing policy, and to Section SA-8 of the *Traffic Signing Manual* for wrong way signing installation details.

RECOMMENDED: “ORIGINAL SIGNED BY”
Director, Traffic Engineering

APPROVED: “ORIGINAL SIGNED BY”
Executive Director
Highway Engineering

TRAFFIC CONTROL AT NEW 4-LANE DIVIDED HIGHWAYS

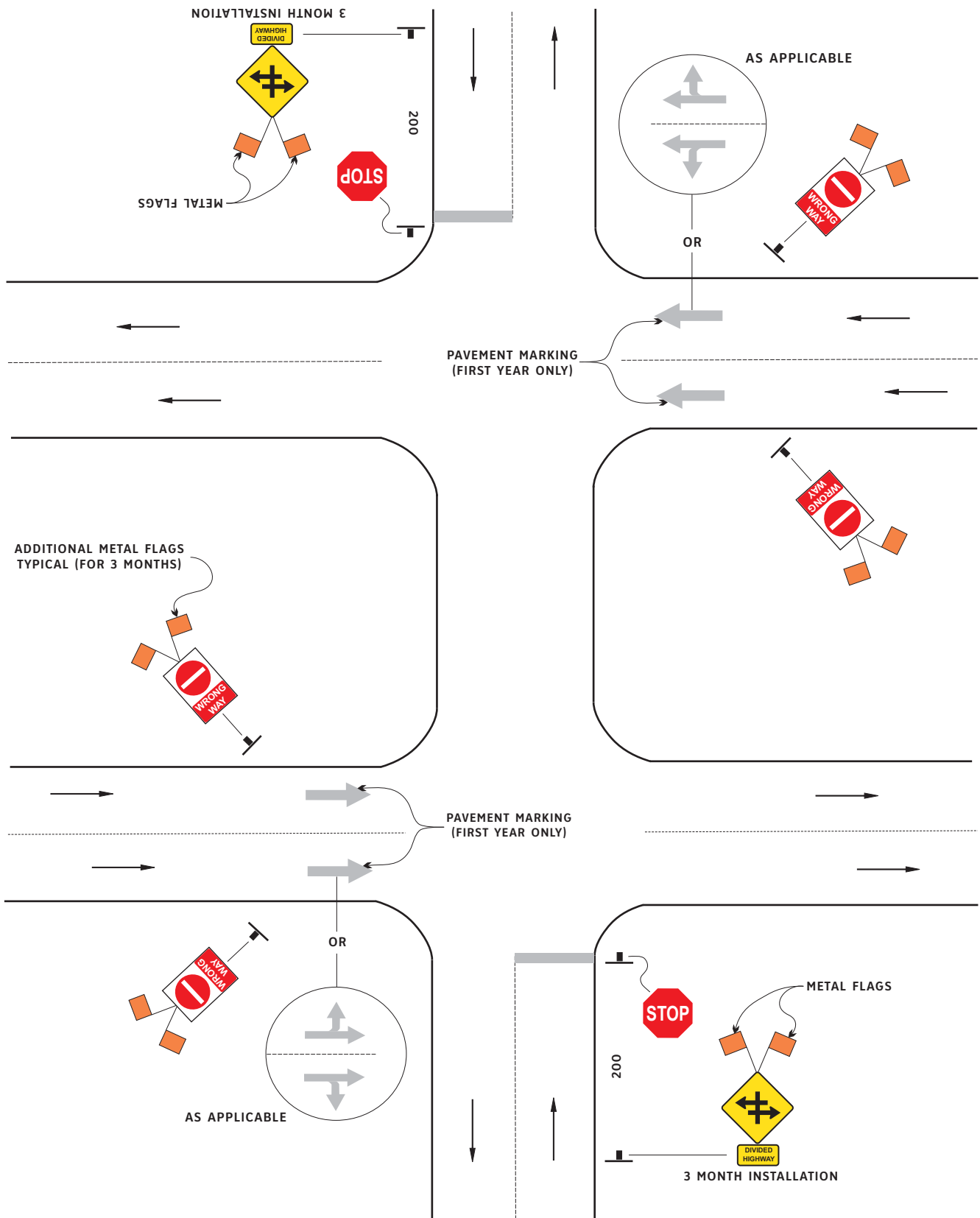

REFER TO SA-8 IN THE 'TRAFFIC SIGNING MANUAL' FOR SIGNING STANDARD AT DIVIDED HIGHWAY INTERSECTIONS

Traffic Control Device: **Work Zone**
Division: **Temporary Warning**
Subject: **Overhead Wires**

Purpose

Signs warning of overhead wires may be beneficial in warning contractors' equipment operators of a potential hazard.

Policy

Orange symbolic OVERHEAD WIRES warning signs (MC-48) may be installed on construction or maintenance projects where equipment extended in the working position (e.g., trucks dumping) may contact overhead wires.

The installation and maintenance of the signs will normally be the responsibility of the contractor.

Standard

When used, the symbolic OVERHEAD WIRES sign and OVERHEAD WIRES tab (MC-48T) should be placed adjacent to the right edge of the road approximately 50 m in advance of the wire crossing. It should be removed when equipment is no longer working in the area. It must be installed on an approved support and be a minimum of 0.60 m above the road surface.



RECOMMENDED: "ORIGINAL SIGNED BY" _____
Director, Traffic Engineering

APPROVED: "ORIGINAL SIGNED BY" _____
Executive Director
Highway Engineering

Work Zone Traffic Control Manual
Index for Drawings (Numerical Listing)

TMP-1	<u>Off Road Work</u> (Roadside & Shoulder Work)	Short/Long Duration
TMP-2	<u>Work in Median</u> (Roadside & Shoulder Work)	Short Duration
TMP-2A	<u>4-Lane Divided Off Road Work</u> (Roadside Median & Off Shoulder Work)	Short/Long Duration
TMP-3	<u>Right Shoulder Work</u> (Roadside & Shoulder Work)	Short Duration
TMP-4	<u>Left Shoulder Work</u> (Roadside & Shoulder Work on Multi-Lane Road)	Short Duration
TMP-5	<u>Encroachment in Right Lane</u> (Roadside & Shoulder Work on 2-Lane Road)	Mobile Operation
TMP-6	<u>Encroachment in Right Lane</u> (Roadside & Shoulder Work on 2-Lane Road)	Short Duration
TMP-7	<u>Encroachment in Right Lane</u> (Roadside & Shoulder Work on 2-Lane Road)	Long Duration
TMP-7A	<u>Right Shoulder Work</u> (Roadside & Shoulder Work on 2-Lane Road)	Long Duration
TMP-7B	<u>Off Shoulder Work - Culvert Jacking</u> (Roadside & Shoulder Work on 2-Lane Road)	Long Duration
TMP-8	<u>Left Shoulder Work</u> (Roadside & Shoulder Work on Multi-Lane Road)	Short/Long Duration
TMP-9	<u>Lane Closure</u> (Single Lane Closed on Multi-Lane Road)	Mobile Operation
TMP-10	<u>Lane Closure</u> (Single Lane Closed on 2-Lane Road)	Mobile Operation
TMP-11	<u>Yield to Oncoming Traffic Volume <60 v/h</u> (Single Lane Closed on 2-Lane Road)	Short Duration
TMP-12	<u>Flagger Controlled Volume >60 v/h</u> (Single Lane Closed on 2-Lane Road)	Short Duration
TMP-13	<u>Right Lane Closed</u> (Single Lane Closed on Multi-Lane Road)	Short Duration

TMP-14	<u>Left Lane Closed</u> (Single Lane Closed on Multi-Lane Road)	Short Duration
TMP-15	<u>Left Lane Closed</u> (Single Lane Closed on Multi-Lane Road)	Long Duration
TMP-16	<u>Right Lane Closed</u> (Single Lane Closed on Multi-Lane Road)	Long Duration
TMP-16A	<u>Lane Drop for Bridge Repair</u> (Single Lane Closed on Multi-Lane Road)	Long Duration
TMP-17	<u>Intersection Near Side Lane Closed</u> (Single Lane Closed on 2-Lane Road)	Short/Long Duration
TMP-18	<u>Intersection Far Side Lane Closed</u> (Single Lane Closed on 2-Lane Road)	Short/Long Duration
TMP-19	<u>Intersection Left Lane Closed</u> (Near side Lane Closed on Multi-Lane Road)	Short/Long Duration
TMP-20	<u>Intersection Right Lane Closed</u> (Near side Lane Closed on Multi-Lane Road)	Short/Long Duration
TMP-21	<u>Intersection Right-Turn Lane Closed</u> (Near side Lane Closed on Multi-Lane Road)	Short/Long Duration
TMP-22	<u>Temporary Road Closure</u> (Areas in the Work Zone)	Short Duration
TMP-23	<u>Shoofly Detour</u> (Areas in the Work Zone)	Short Duration
TMP-23A	<u>Bump Due to Construction</u> (Areas in the Work Zone)	Short Duration
TMP-24	<u>Shoofly Detour</u> (Areas in the Work Zone)	Long Duration
TMP-24A	<u>Narrow Shoofly Detour - Low Volume</u> (Areas in the Work Zone)	Long Duration
TMP-25	<u>4-Lane Divided to 2-Lane 2-Way</u> (Areas in the Work Zone)	Long Duration
TMP-26	<u>Traffic Control using a Pilot Vehicle</u> (Areas in the Work Zone)	Short Duration

TMP-26A	<u>Traffic Control using a Pilot Vehicle</u> (Areas in the Work Zone)	Long Duration
TMP-27	<u>Gravel Piles in Center of Roadway</u> (Areas in the Work Zone)	Short Duration
TMP-28	<u>Typical Paving Operation</u> (Areas in the Work Zone)	Short Duration
TMP-29	<u>Sealcoat Project</u> (Areas in the Work Zone)	Short Duration
TMP-30	<u>Temporary Aircraft Operations on PR's</u> (Areas in the Work Zone)	Short Duration
TMP-31	<u>Joint Repair Lane Closed</u> (Areas in the Work Zone)	Short Duration
TMP-32	<u>Single Lane Bridge Work w/ Signals</u> (Areas in the Work Zone)	Long Duration
TMP-33	<u>Single Lane Bridge Work w/o Signals</u> (Areas in the Work Zone)	Long Duration
TMP-34	<u>4-Lane Divided – Wide Turning Trucks</u> (Areas in the Work Zone)	Short Duration
TMP-35	<u>Route and Seal Operation</u> (Single Lane Closed on 2-Lane Road)	Short Duration
TMP-36	<u>Pilot Vehicle for a Steep Hill</u> (Areas in the Work Zone)	Long Duration
TMP-37	<u>Pilot Vehicle for a Blind Curve</u> (Areas in the Work Zone)	Short Duration

Mobile Operations

S-TMP-1	<u>Pavement Structural Testing 2-Lane</u> (Areas in the Work Zone)	Fast Moving Operation
S-TMP-1A	<u>Pavement Structural Testing Multi-Lane</u> (Areas in the Work Zone)	Fast Moving Operation
S-TMP-2	<u>Soil Drill Truck / Coring Vehicle</u> (Areas in the Work Zone)	Fast Moving Operation

S-TMP-3	<u>Profilograph Unit</u> (Areas in the Work Zone)	Fast Moving Operation
S-TMP-4	<u>Nuclear Density Testing</u> (Areas in the Work Zone)	Fast Moving Operation
S-TMP-5	<u>Hi-Low Testing</u> (Areas in the Work Zone)	Fast Moving Operation
S-TMP-6	<u>Trucks Hauling Long Bridge Girders</u> (Areas in the Work Zone)	Short Duration
S-TMP-7	<u>Asphalite Operation</u> (Areas in the Work Zone)	Fast Moving Operation
S-TMP-8	<u>Maintenance Gravelling Operation</u> (Areas in the Work Zone)	Mobile Operation
S-TMP-9	<u>Planned Traffic Signal Repair (Low)</u> (Signalized Intersection)	Short Duration
S-TMP-10	<u>Planned Traffic Signal Repair (High)</u> (Signalized Intersection)	Short Duration
S-TMP11	<u>Pavement Marking Operation 2-Lane</u> (Areas in the Work Zone)	Fast Moving Operation
S-TMP12	<u>Pavement Marking Operation Multi-Lane</u> (Areas in the Work Zone)	Fast Moving Operation
S-TMP13	<u>Pav. Marking Stop Control 2-Lane</u> (Rural Pavement Marking Operation)	Short Duration
S-TMP13A	<u>Pav. Marking Stop Control Multi-Lane</u> (Rural Pavement Marking Operation)	Short Duration
S-TMP14	<u>Near Side Intersection Pav. Marking</u> (Urban Pavement Marking Operation)	Short Duration
S-TMP14A	<u>Far Side Intersection Pav. Marking</u> (Urban Pavement Marking Operation)	Short Duration
S-TMP15	<u>Near Side Intersection Signalized 2-Lane</u> (Rural Pavement Marking Operation)	Short Duration
S-TMP15A	<u>Far Side Intersection Signalized 2-Lane</u> (Rural Pavement Marking Operation)	Short Duration

S-TMP16	<u>Stop Line/Corridor Signalized Multi-Lane</u> (Rural Pavement Marking Operation)	Short Duration
S-TMP16A	<u>Stop Line/Corridor Signalized Multi-Lane</u> (Rural Pavement Marking Operation)	Short Duration
S-TMP17	<u>Gore Area/Bypass Lane 2-Lane</u> (Rural Pavement Marking Operation)	Short Duration
S-TMP18	<u>Flagger Controlled Volume >60 v/h</u> (Micro-Surfacing)	Short Duration
S-TMP19	<u>Centerline Survey Work Multi-Lane Road</u> (Conventional Survey)	Short Duration
S-TMP20	<u>Centerline Survey Work 2-Lane Road</u> (Conventional Survey)	Short Duration
S-TMP21	<u>Centerline Survey Work Multi-Lane Road</u> (Electronic Allegro Survey)	Short Duration
S-TMP22	<u>Centerline Survey Work 2-Lane Road</u> (Electronic Allegro Survey)	Short Duration
S-TMP-23	<u>Roadside and Shoulder Work</u> (Off Road Work – Hydro Transmission Line Const)	Short Duration
S-TMP23A	<u>Building Move (including Grain Bins)</u> (Hydro Conductor Lift)	Mobile Operation
S-TMP23B	<u>Building Move (including Grain Bins)</u> (Hydro Conductor Lift w/ Bucket Truck)	Mobile Operation
S-TMP23C	<u>Building Move (including Grain Bins)</u> (Hydro Conductor Cut Down)	Mobile Operation

S(km/h)	A(m)	L(m)	B(m)	D(m)
50	50	60	35	15
60	50	90	45	15
70	75	120	50	15
80	100	175	55	15
90	100	200	65	20
100	150	250	70	20

WHERE:
S = SPEED LIMIT
A = SPACING BETWEEN SIGNS
L = LENGTH OF TAPER (SEE POLICY 900-B-12 FOR CHANNELIZATION DEVICE)
B = LENGTH OF LONGITUDINAL BUFFER SPACE
D = SPACING BETWEEN DELINEATION DEVICES

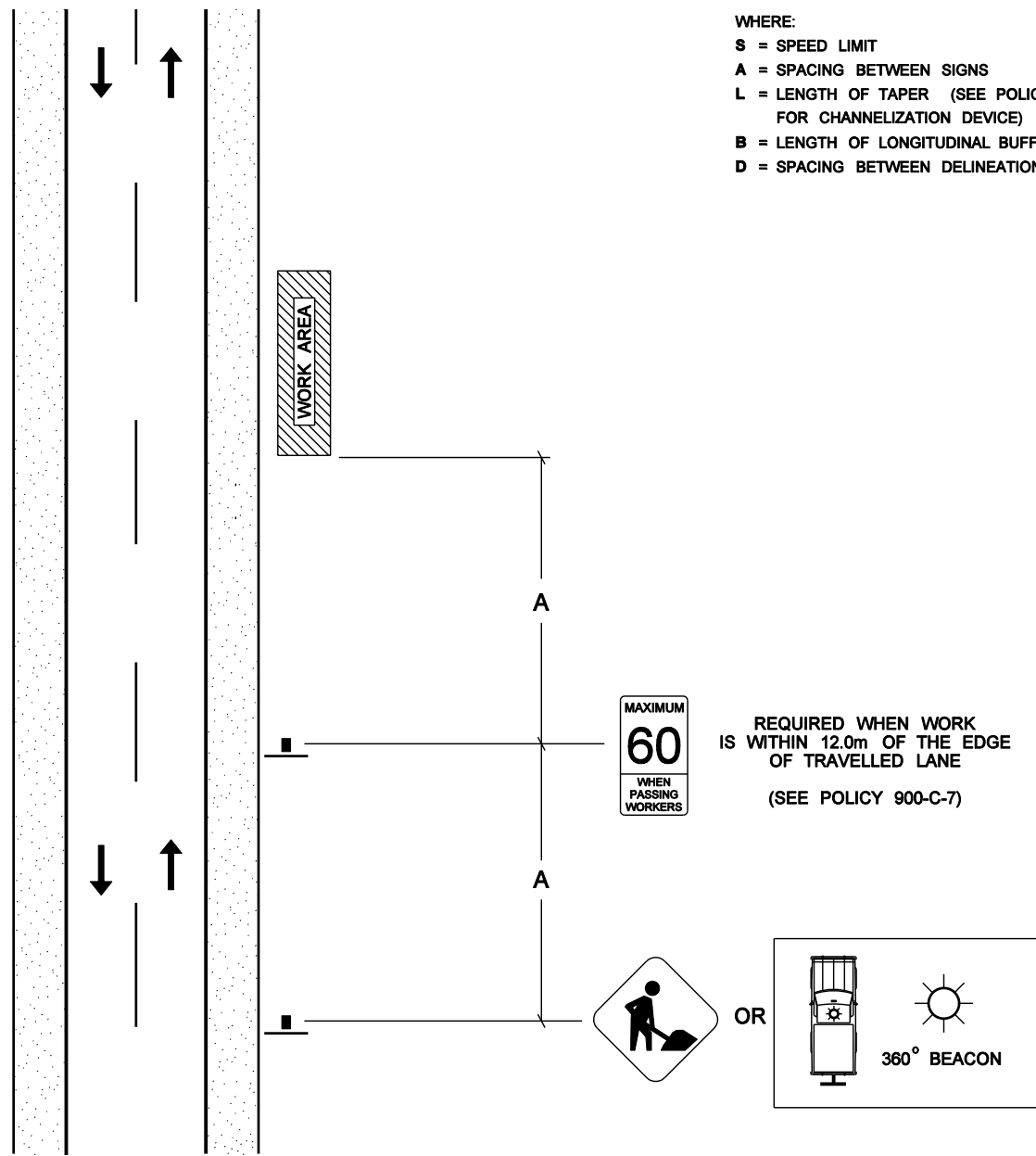

WORK IN MEDIAN

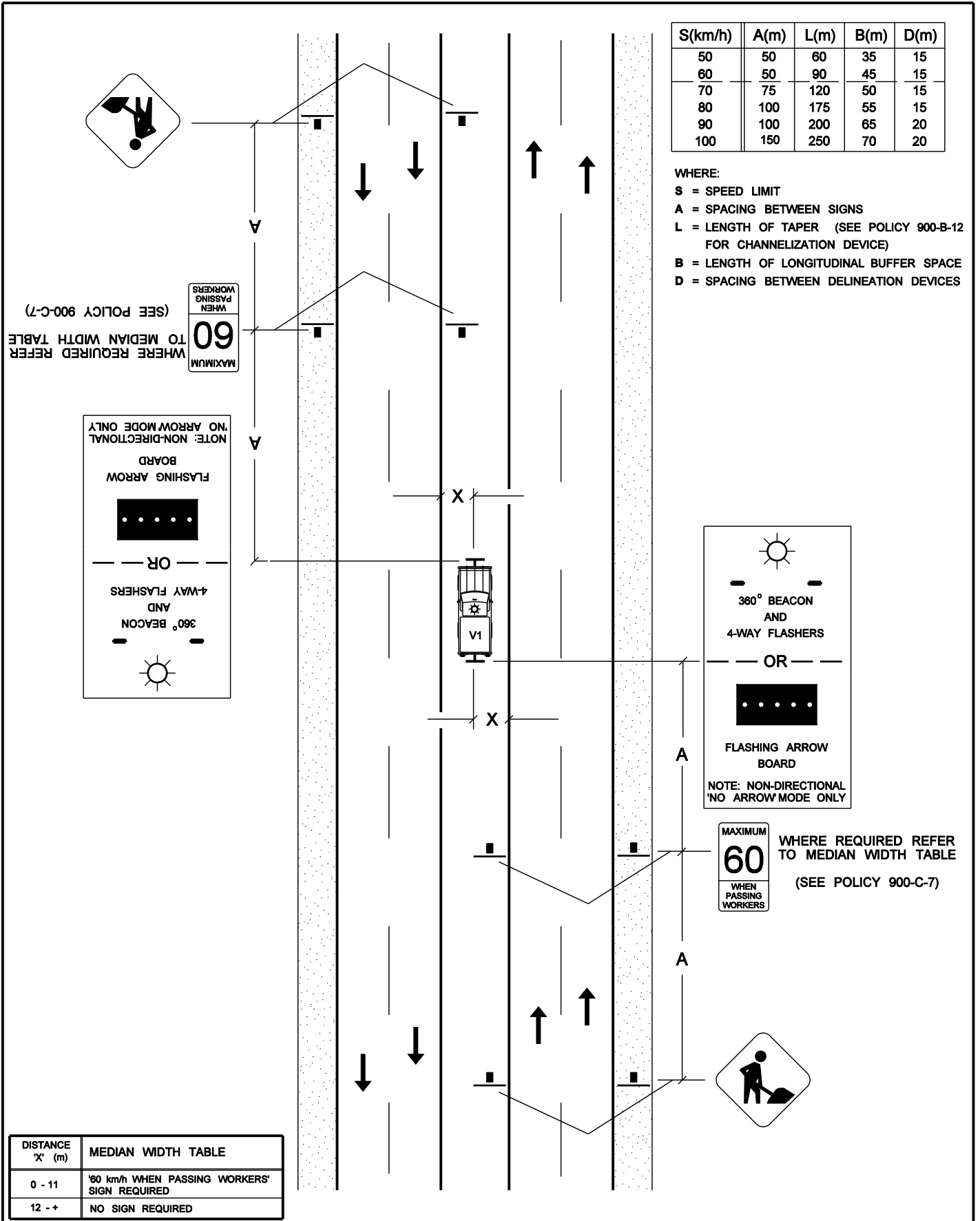

4 - LANE DIVIDED OFF ROAD WORK

CONTRACTOR SHOULD
PARK OFF SHOULDER

S(km/h)	A(m)
50	50
60	50
70	75
80	100
90	100
100	150

WHERE:
S = SPEED LIMIT
A = SPACING BETWEEN SIGNS

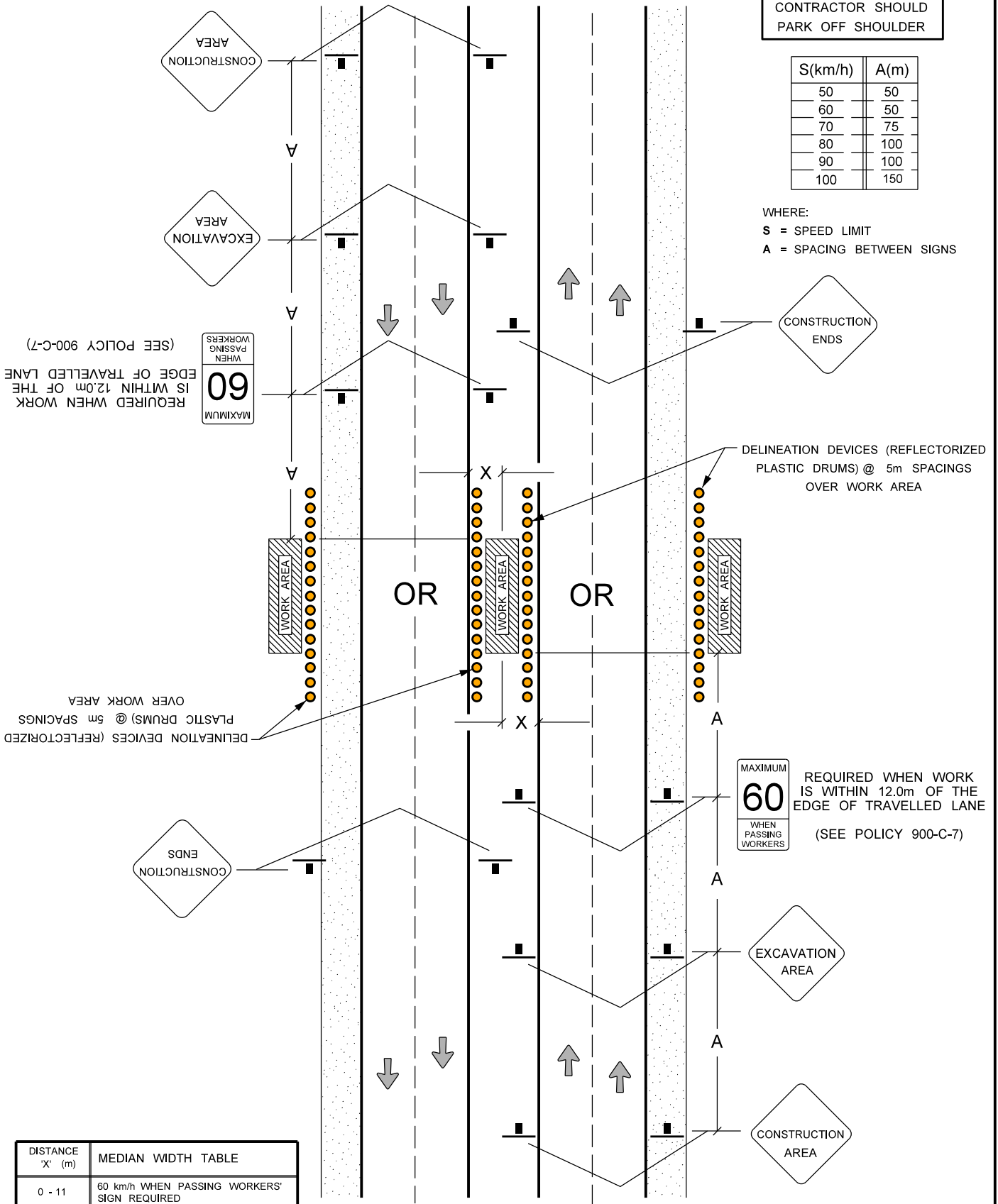

REQUIRED WHEN WORK IS WITHIN 12.0m OF THE EDGE OF TRAVELLED LANE (SEE POLICY 900-C-7)

DELINEATION DEVICES (REFLECTORIZED PLASTIC DRUMS) @ 5m SPACINGS OVER WORK AREA

REQUIRED WHEN WORK IS WITHIN 12.0m OF THE EDGE OF TRAVELLED LANE (SEE POLICY 900-C-7)

DISTANCE 'X' (m)	MEDIAN WIDTH TABLE
0 - 11	60 km/h WHEN PASSING WORKERS' SIGN REQUIRED
12 - +	NO SIGN REQUIRED

RIGHT SHOULDER WORK

S(km/h)	A(m)	L(m)	B(m)	D(m)
50	50	60	35	15
60	50	90	45	15
70	75	120	50	15
80	100	175	55	15
90	100	200	65	20
100	150	250	70	20

WHERE:
S = SPEED LIMIT
A = SPACING BETWEEN SIGNS
L = LENGTH OF TAPER (SEE POLICY 900-B-12 FOR CHANNELIZATION DEVICE)
B = LENGTH OF LONGITUDINAL BUFFER SPACE
D = SPACING BETWEEN DELINEATION DEVICES

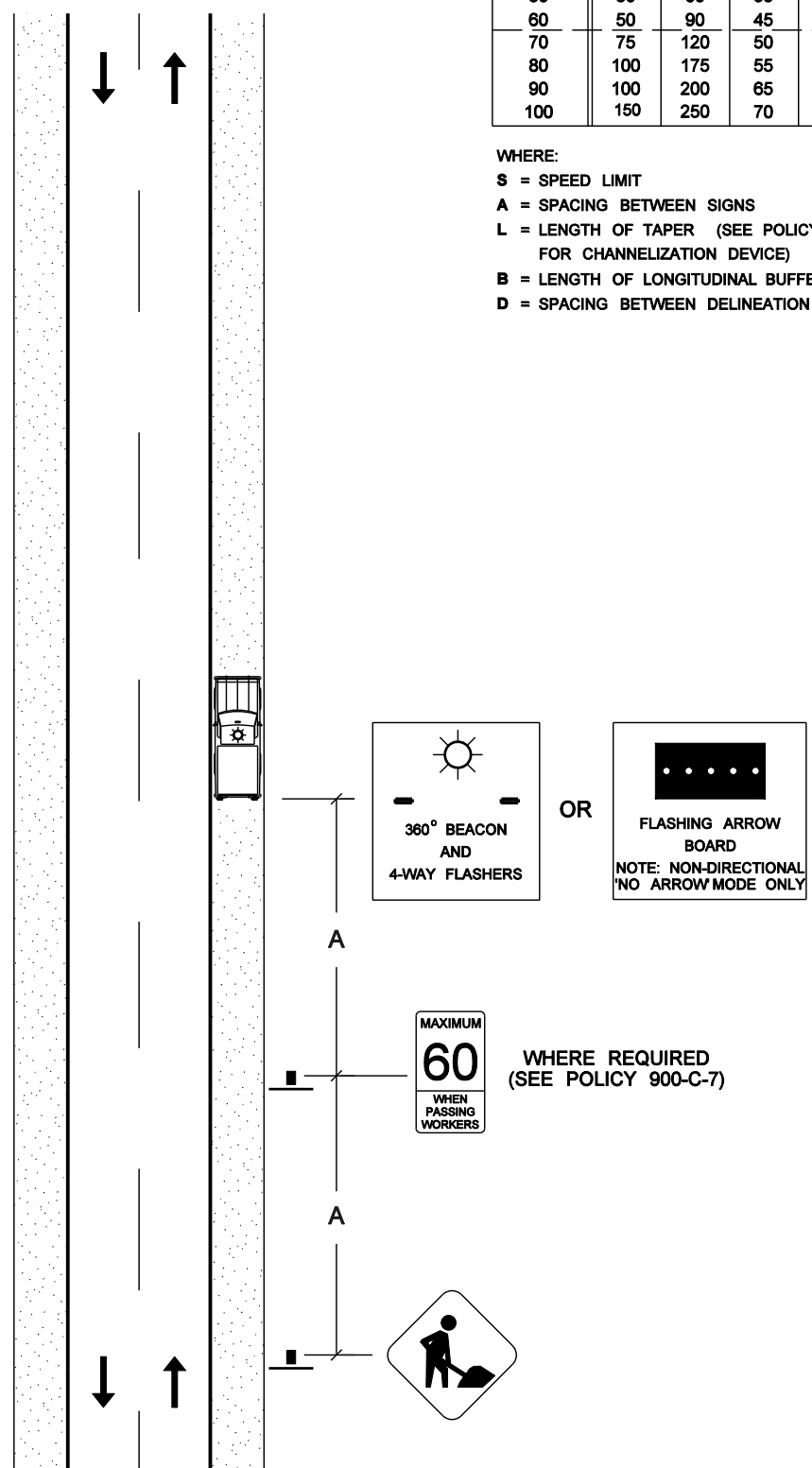

LEFT SHOULDER WORK

S(km/h)	A(m)	L(m)	B(m)	D(m)
50	50	60	35	15
60	50	90	45	15
70	75	120	50	15
80	100	175	55	15
90	100	200	65	20
100	150	250	70	20

WHERE:

S = SPEED LIMIT

A = SPACING BETWEEN SIGNS

L = LENGTH OF TAPER (SEE POLICY 900-B-12 FOR CHANNELIZATION DEVICE)

B = LENGTH OF LONGITUDINAL BUFFER SPACE

D = SPACING BETWEEN DELINEATION DEVICES

WHERE REQUIRED
 (SEE POLICY 900-C-7)

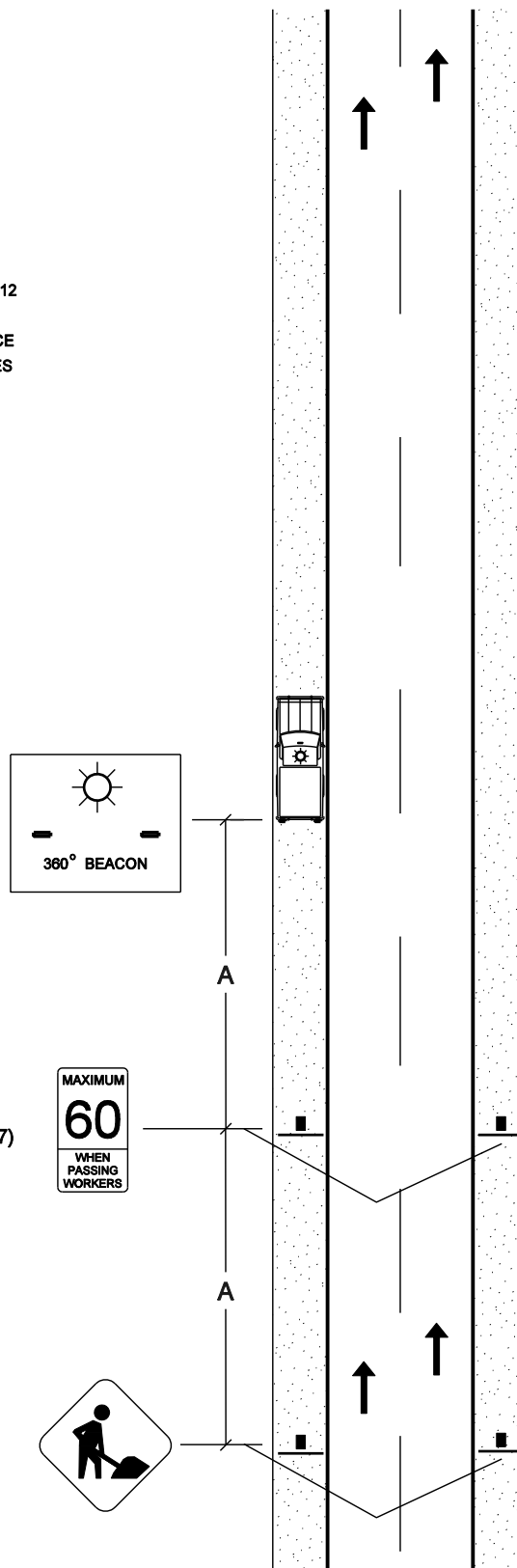

ENCROACHMENT IN RIGHT LANE

S(km/h)	A(m)	L(m)	B(m)	D(m)
50	50	60	35	15
60	50	90	45	15
70	75	120	50	15
80	100	175	55	15
90	100	200	65	20
100	150	250	70	20

WHERE:

S = SPEED LIMIT

A = SPACING BETWEEN SIGNS

L = LENGTH OF TAPER (SEE POLICY 900-B-12 FOR CHANNELIZATION DEVICE)

B = LENGTH OF LONGITUDINAL BUFFER SPACE

D = SPACING BETWEEN DELINEATION DEVICES

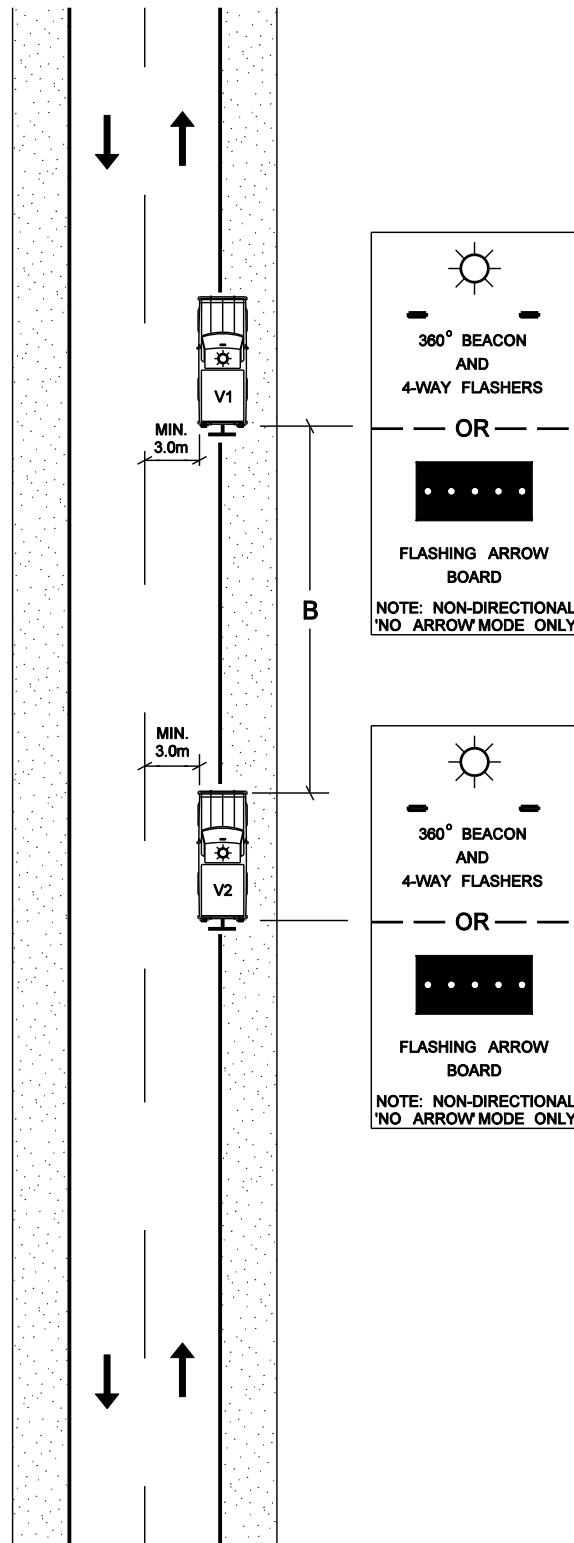

LEGEND	
V1	= WORK TRUCK
V2	= BUFFER TRUCK

ENCROACHMENT IN RIGHT LANE

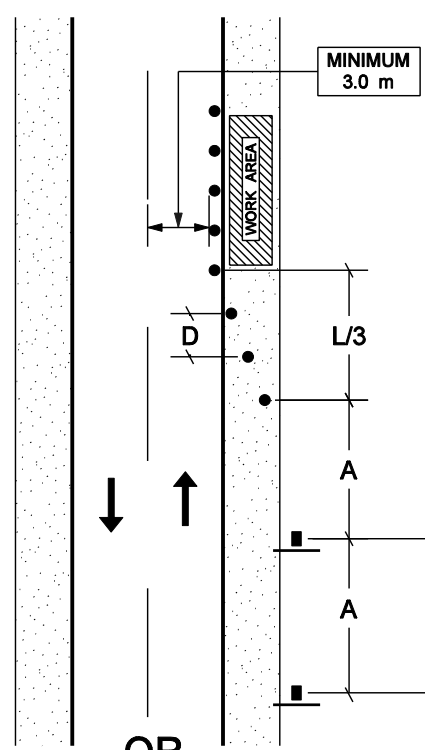



S(km/h)	A(m)	L(m)	B(m)	D(m)
50	50	60	35	15
60	50	90	45	15
70	75	120	50	15
80	100	175	55	15
90	100	200	65	20
100	150	250	70	20

WHERE:
S = SPEED LIMIT
A = SPACING BETWEEN SIGNS
L = LENGTH OF TAPER (SEE POLICY 900-B-12 FOR CHANNELIZATION DEVICE)
B = LENGTH OF LONGITUDINAL BUFFER SPACE
D = SPACING BETWEEN DELINEATION DEVICES

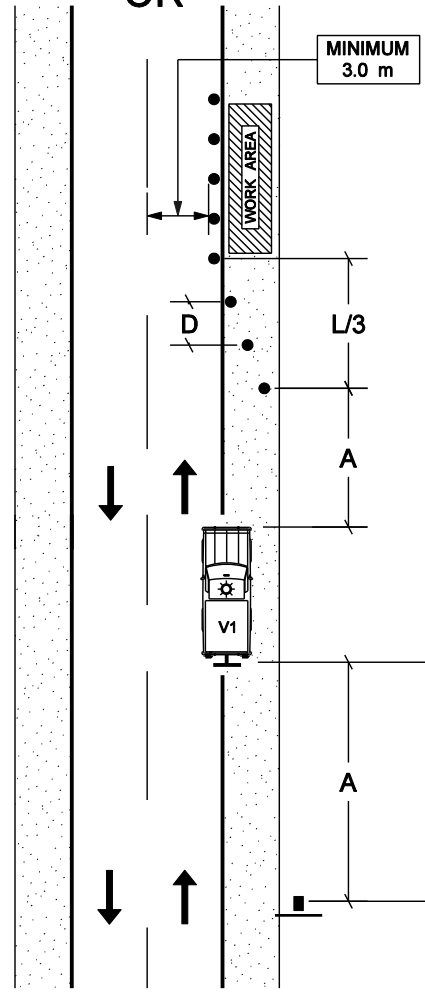
OR



 360° BEACON
 AND
 4-WAY FLASHERS
 OR

 FLASHING ARROW
 BOARD
 NOTE: NON-DIRECTIONAL
 'NO ARROW MODE ONLY'

ENCROACHMENT IN RIGHT LANE

S(km/h)	A(m)	L(m)	B(m)	D(m)
50	50	60	35	15
60	50	90	45	15
70	75	120	50	15
80	100	175	55	15
90	100	200	65	20
100	150	250	70	20

WHERE:

S = SPEED LIMIT

A = SPACING BETWEEN SIGNS

L = LENGTH OF TAPER (SEE POLICY 900-B-12 FOR CHANNELIZATION DEVICE)

B = LENGTH OF LONGITUDINAL BUFFER SPACE

D = SPACING BETWEEN DELINEATION DEVICES

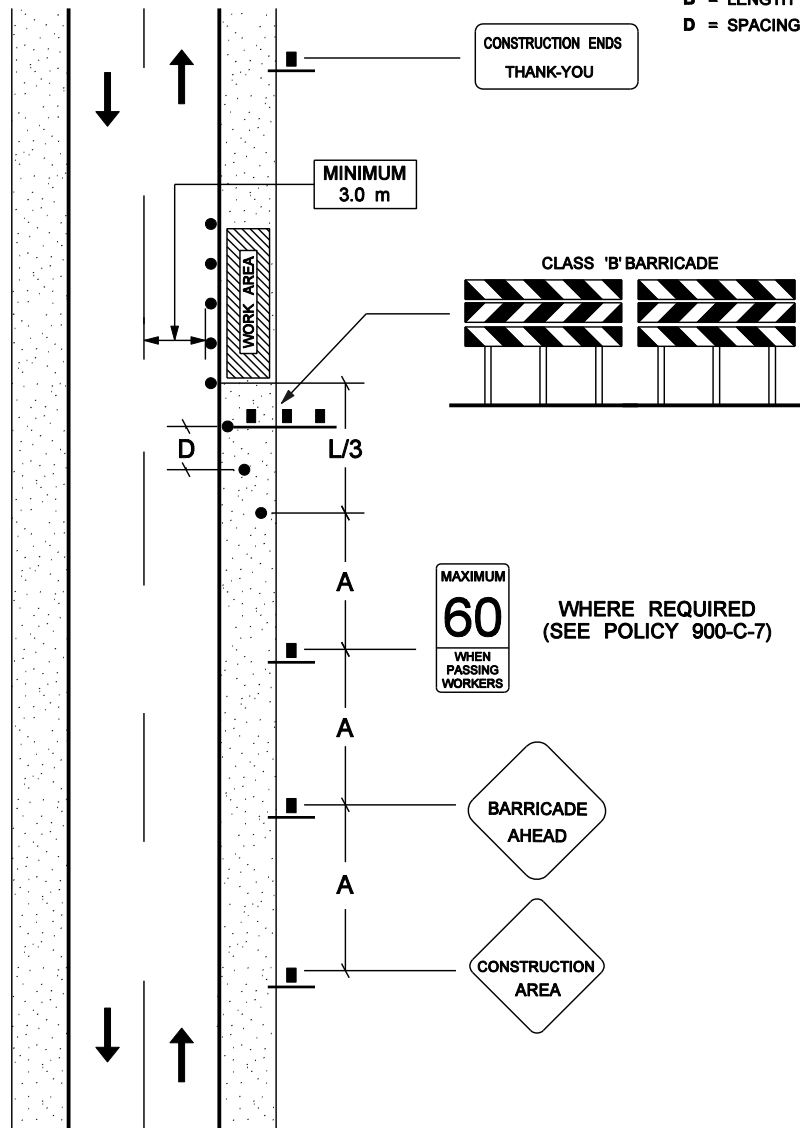

RIGHT SHOULDER WORK

S(km/h)	A(m)	L(m)	B(m)	D(m)
50	50	60	35	15
60	50	90	45	15
70	75	120	50	15
80	100	175	55	15
90	100	200	65	20
100	150	250	70	20

WHERE:

S = SPEED LIMIT

A = SPACING BETWEEN SIGNS

L = LENGTH OF TAPER (SEE POLICY 900-B-12 FOR CHANNELIZATION DEVICE)

B = LENGTH OF LONGITUDINAL BUFFER SPACE

D = SPACING BETWEEN DELINEATION DEVICES

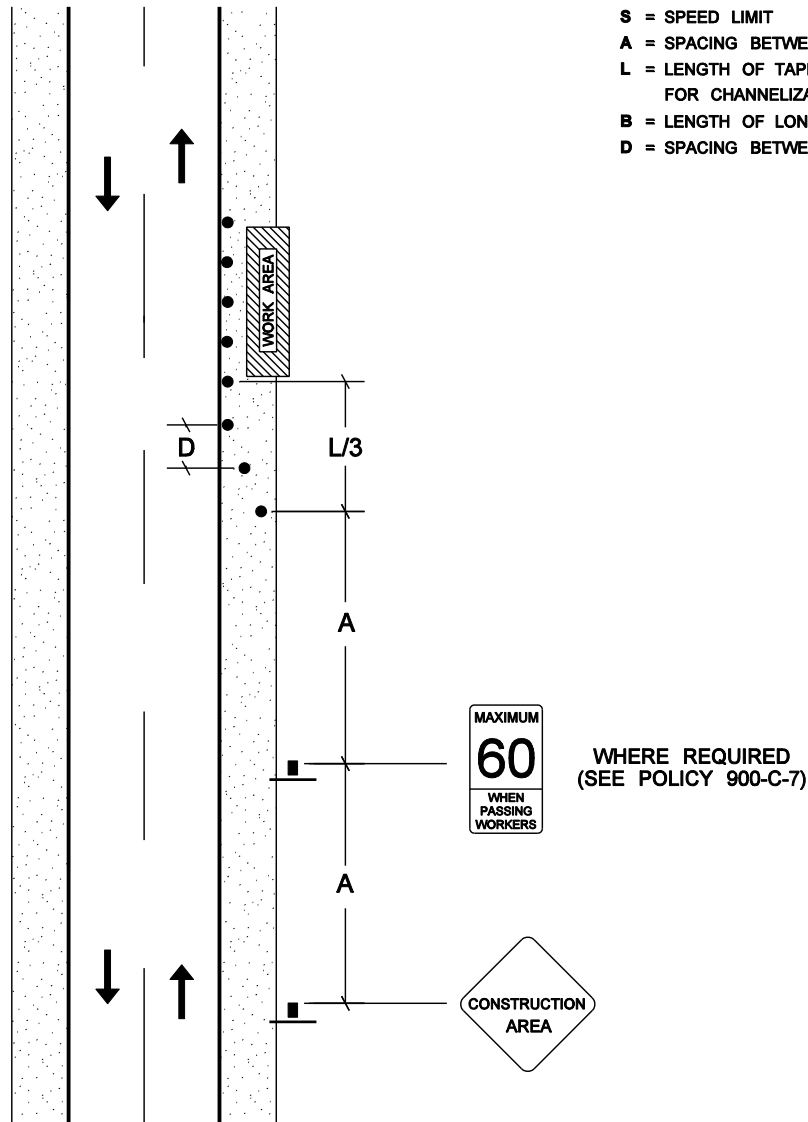

LEFT SHOULDER WORK

S(km/h)	A(m)	L(m)	B(m)	D(m)
50	50	60	35	15
60	50	90	45	15
70	75	120	50	15
80	100	175	55	15
90	100	200	65	20
100	150	250	70	20

WHERE:

S = SPEED LIMIT

A = SPACING BETWEEN SIGNS

L = LENGTH OF TAPER (SEE POLICY 900-B-12
 FOR CHANNELIZATION DEVICE)

B = LENGTH OF LONGITUDINAL BUFFER SPACE

D = SPACING BETWEEN DELINEATION DEVICES

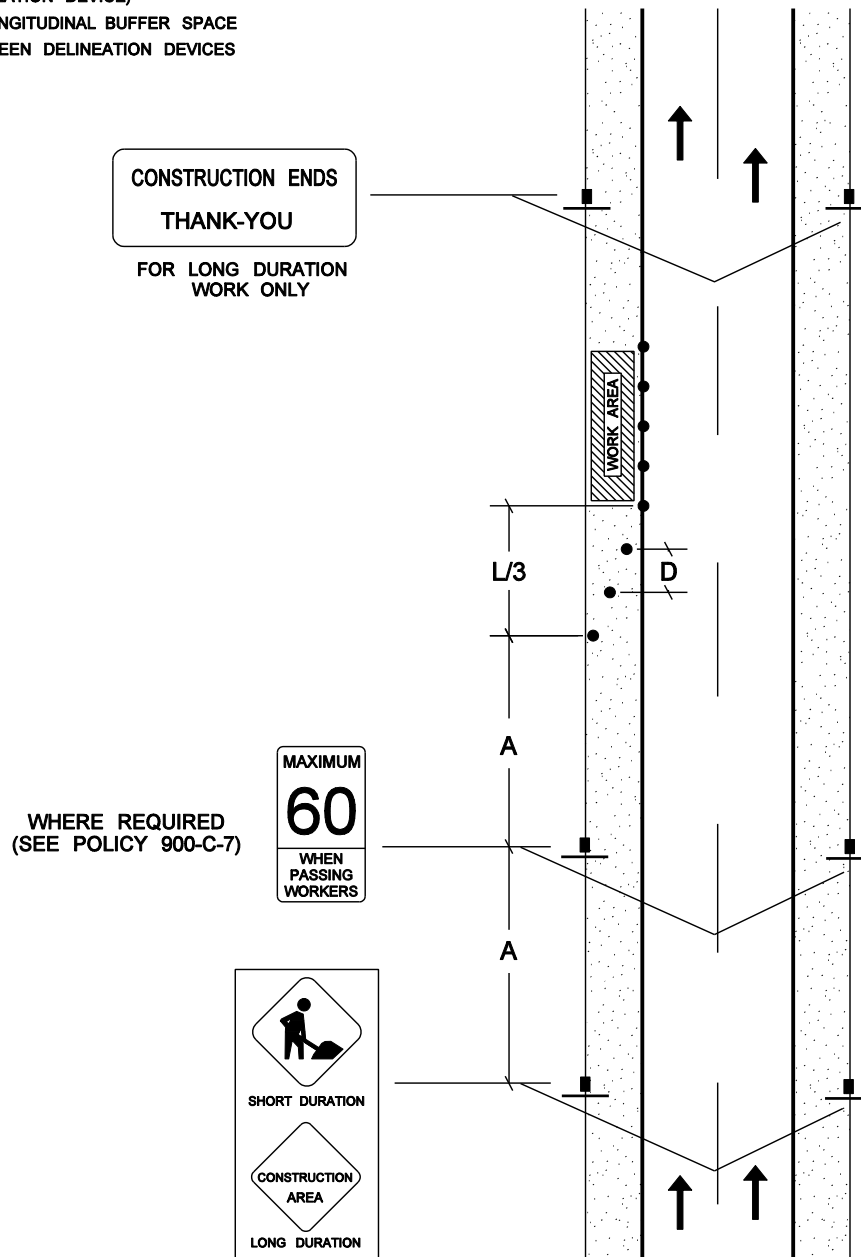

SINGLE LANE CLOSED

MULTI-LANE ROAD

S(km/h)	A(m)	L(m)	B(m)	D(m)
50	50	60	35	15
60	50	90	45	15
70	75	120	50	15
80	100	175	55	15
90	100	200	65	20
100	150	250	70	20

WHERE:

S = SPEED LIMIT

A = SPACING BETWEEN SIGNS

L = LENGTH OF TAPER (SEE POLICY 900-B-12
 FOR CHANNELIZATION DEVICE)

B = LENGTH OF LONGITUDINAL BUFFER SPACE

D = SPACING BETWEEN DELINEATION DEVICES

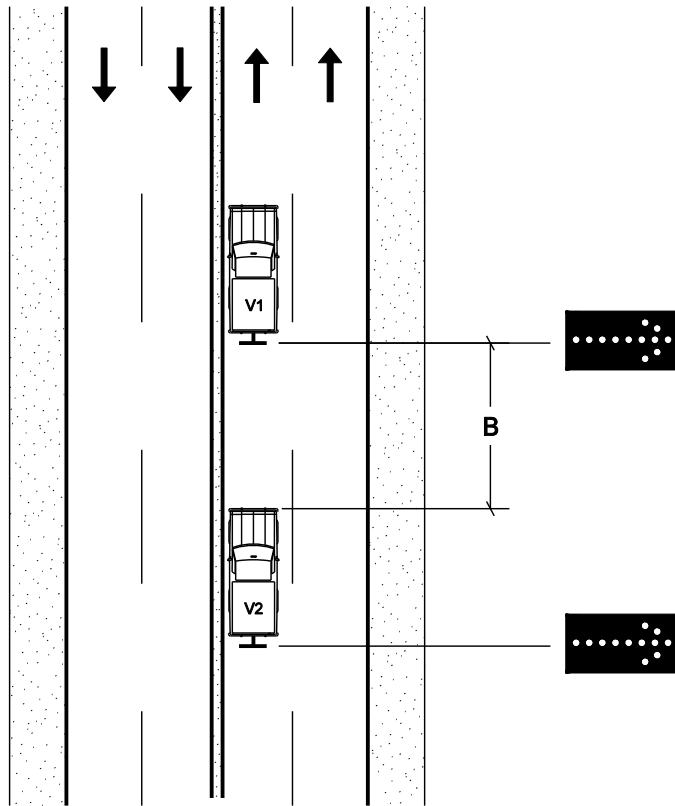

OR

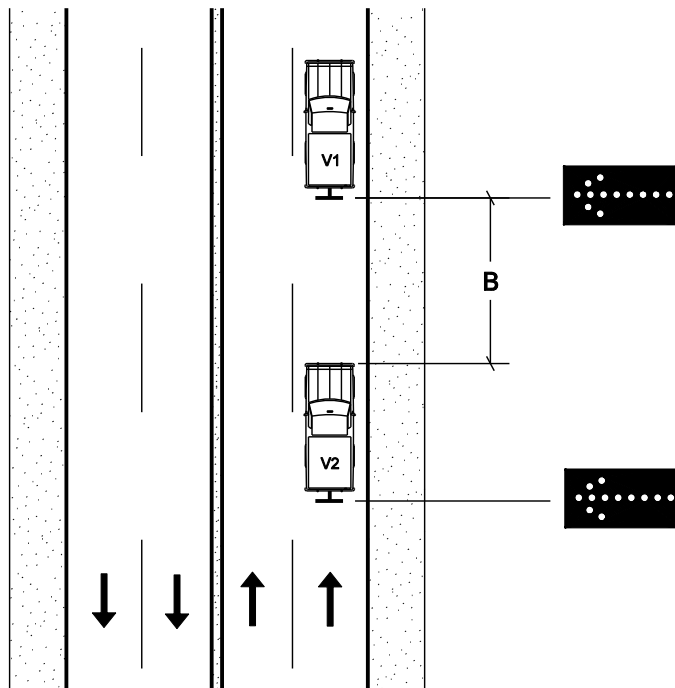

LEGEND
V1 = WORK TRUCK
V2 = BUFFER TRUCK

SINGLE LANE CLOSED

TWO - LANE ROAD

S(km/h)	A(m)	L(m)	B(m)	D(m)
50	50	60	35	15
60	50	90	45	15
70	75	120	50	15
80	100	175	55	15
90	100	200	65	20
100	150	250	70	20

WHERE:

S = SPEED LIMIT

A = SPACING BETWEEN SIGNS

L = LENGTH OF TAPER (SEE POLICY 900-B-12 FOR CHANNELIZATION DEVICE)

B = LENGTH OF LONGITUDINAL BUFFER SPACE

D = SPACING BETWEEN DELINEATION DEVICES

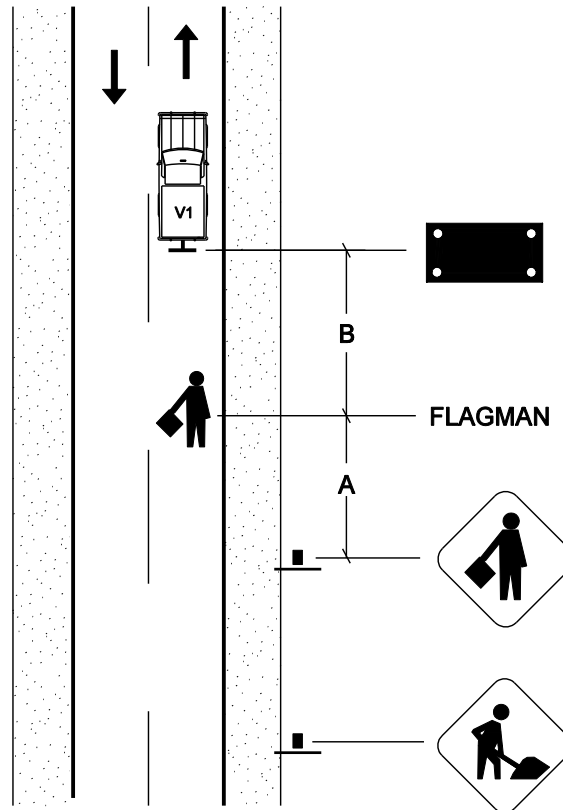

OR

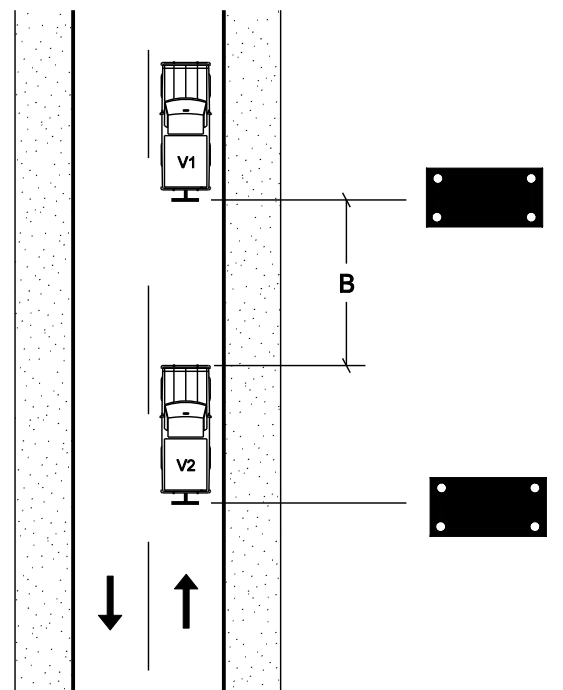

LEGEND	
V1	= WORK TRUCK
V2	= BUFFER TRUCK

SINGLE LANE CLOSED

TWO-LANE ROAD - YIELD TO ONCOMING TRAFFIC VOLUME < 60 VEHICLES/HOUR

S(km/h)	A(m)	L(m)	B(m)	D(m)
50	50	60	35	15
60	50	90	45	15
70	75	120	50	15
80	100	175	55	15
90	100	200	65	20
100	150	250	70	20

WHERE:

S = SPEED LIMIT

A = SPACING BETWEEN SIGNS

L = LENGTH OF TAPER (SEE POLICY 900-B-12 FOR CHANNELIZATION DEVICE)

B = LENGTH OF LONGITUDINAL BUFFER SPACE

D = SPACING BETWEEN DELINEATION DEVICES

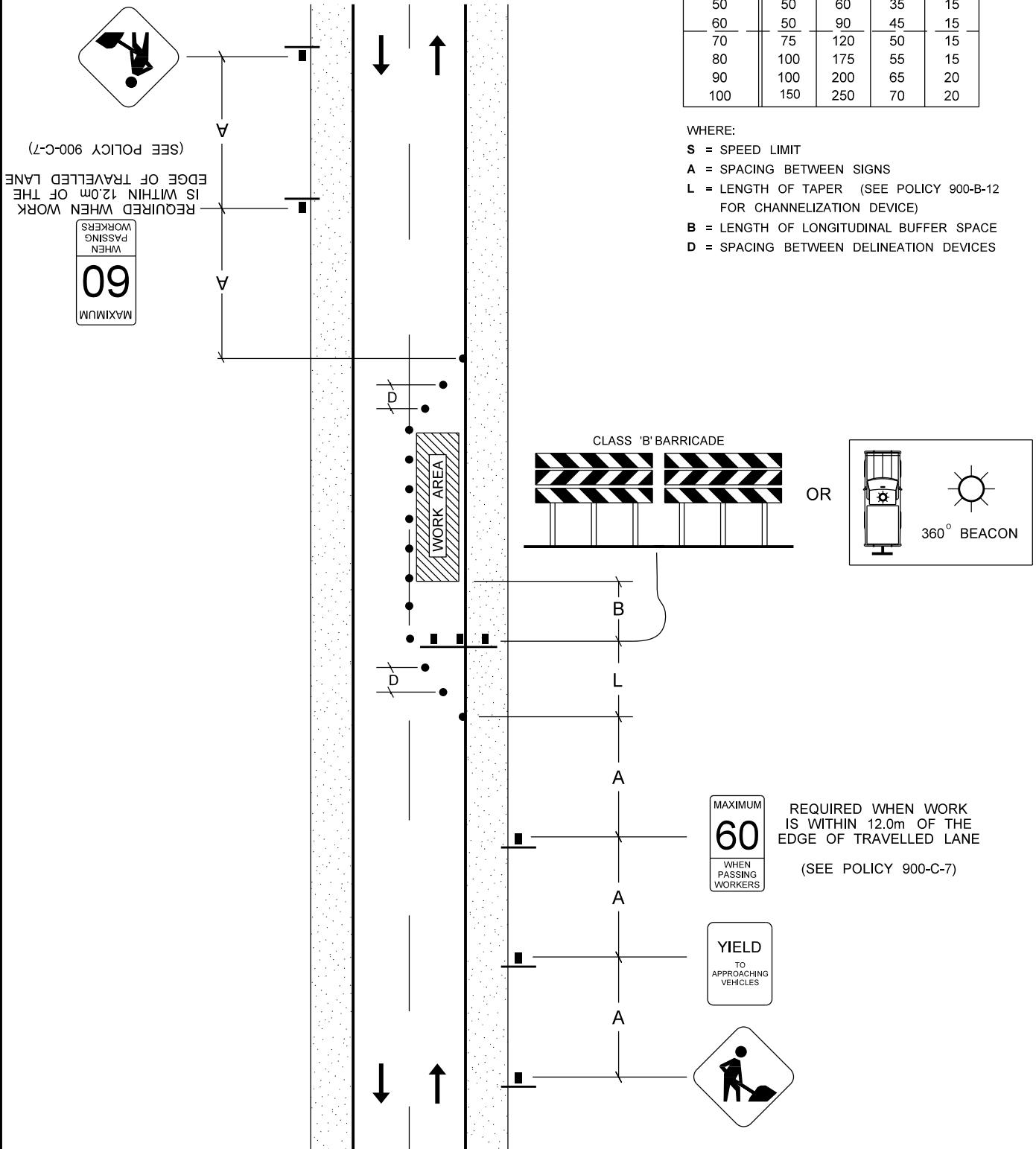

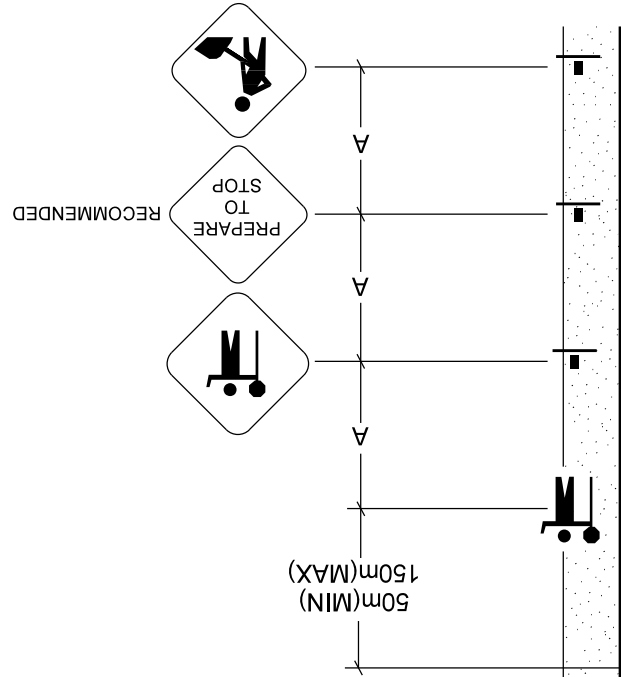

S(km/h)	A(m)	L(m)	B(m)	D(m)
50	50	60	35	15
60	50	90	45	15
70	75	120	50	15
80	100	175	55	15
90	100	200	65	20
100	150	250	70	20

WHERE:
S = SPEED LIMIT
A = SPACING BETWEEN SIGNS
L = LENGTH OF TAPER (SEE POLICY 900-B-12 FOR CHANNELIZATION DEVICE)
B = LENGTH OF LONGITUDINAL BUFFER SPACE
D = SPACING BETWEEN DELINEATION DEVICES

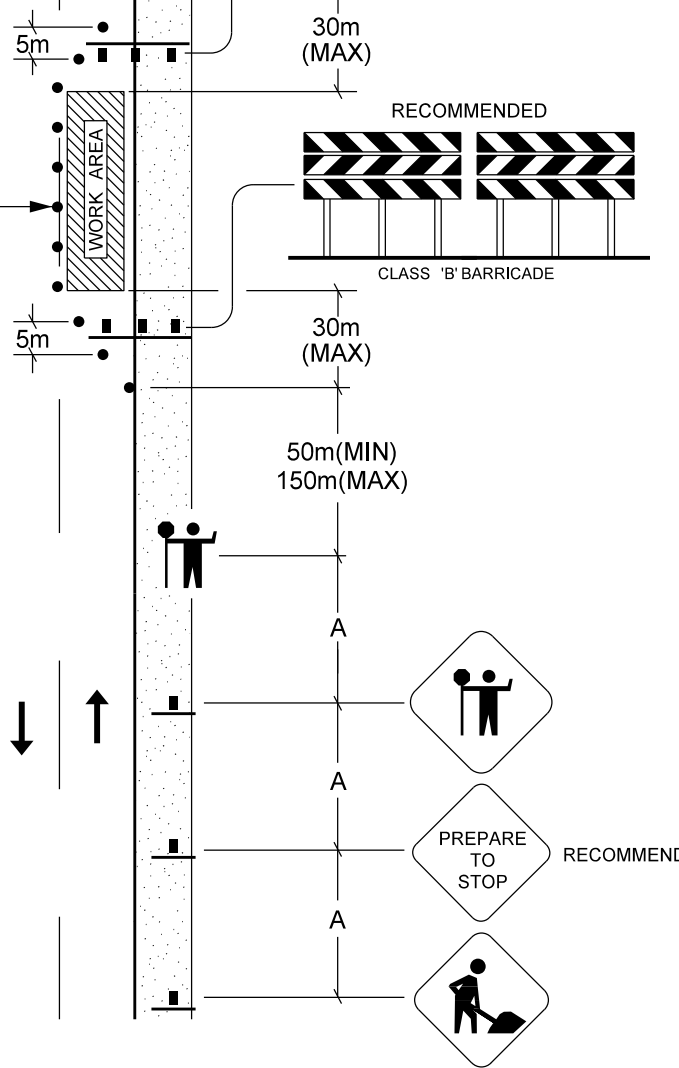

NOTE:
 ADDITIONAL FLAG PERSON REQUIRED WHEN QUEUE REACHES FLAGPERSON SIGN.
 ADVANCE WARNING WITH ADDITIONAL FLAG PERSON SIGN.

SINGLE LANE CLOSED

MULTI-LANE ROAD - LEFT LANE CLOSED

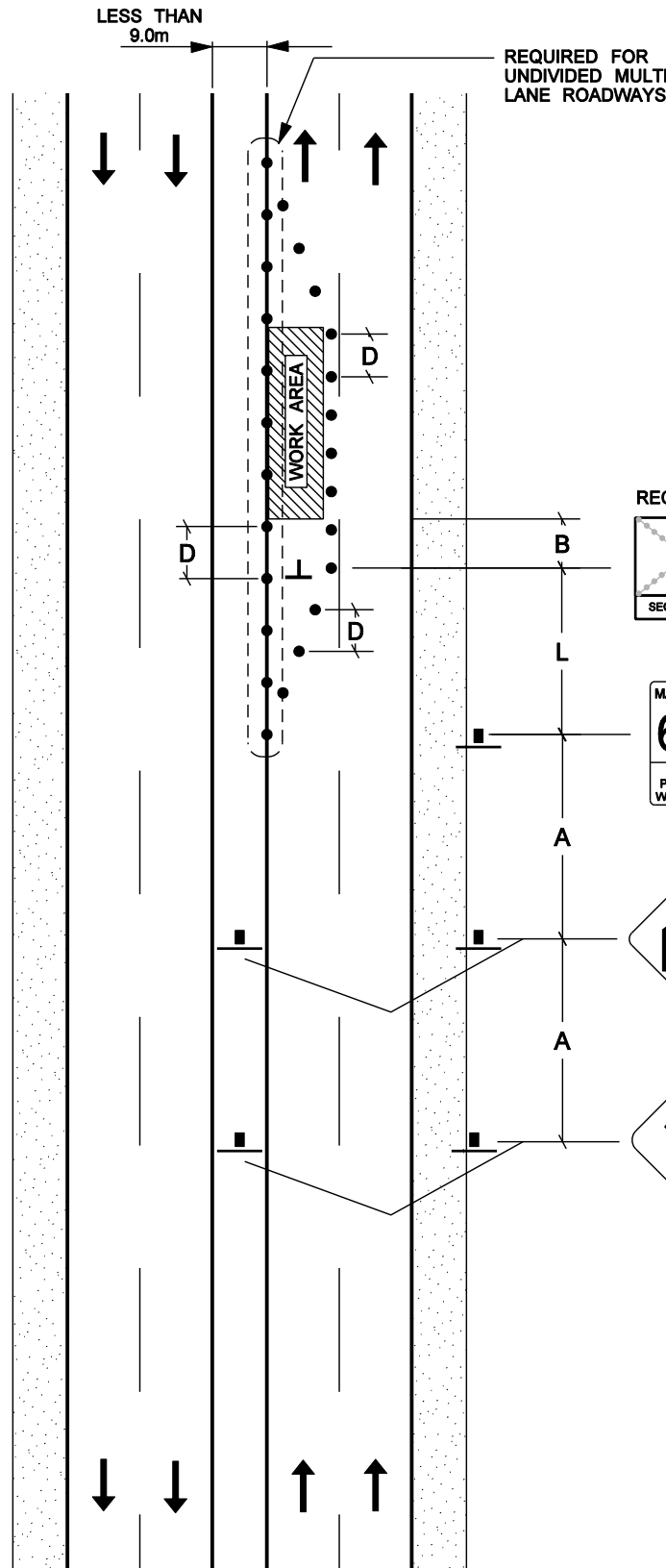

S(km/h)	A(m)	L(m)	B(m)	D(m)
50	50	60	35	15
60	50	90	45	15
70	75	120	50	15
80	100	175	55	15
90	100	200	65	20
100	150	250	70	20

WHERE:

S = SPEED LIMIT

A = SPACING BETWEEN SIGNS

L = LENGTH OF TAPER (SEE POLICY 900-B-12 FOR CHANNELIZATION DEVICE)

B = LENGTH OF LONGITUDINAL BUFFER SPACE

D = SPACING BETWEEN DELINEATION DEVICES

RECOMMENDED

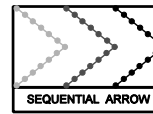

OR

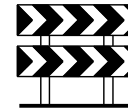

WHERE REQUIRED
(SEE POLICY 900-C-7)



SINGLE LANE CLOSED

MULTI-LANE ROAD - RIGHT LANE CLOSED

S(km/h)	A(m)	L(m)	B(m)	D(m)
50	50	60	35	15
60	50	90	45	15
70	75	120	50	15
80	100	175	55	15
90	100	200	65	20
100	150	250	70	20

WHERE:

S = SPEED LIMIT

A = SPACING BETWEEN SIGNS

L = LENGTH OF TAPER (SEE POLICY 900-B-12 FOR CHANNELIZATION DEVICE)

B = LENGTH OF LONGITUDINAL BUFFER SPACE

D = SPACING BETWEEN DELINEATION DEVICES

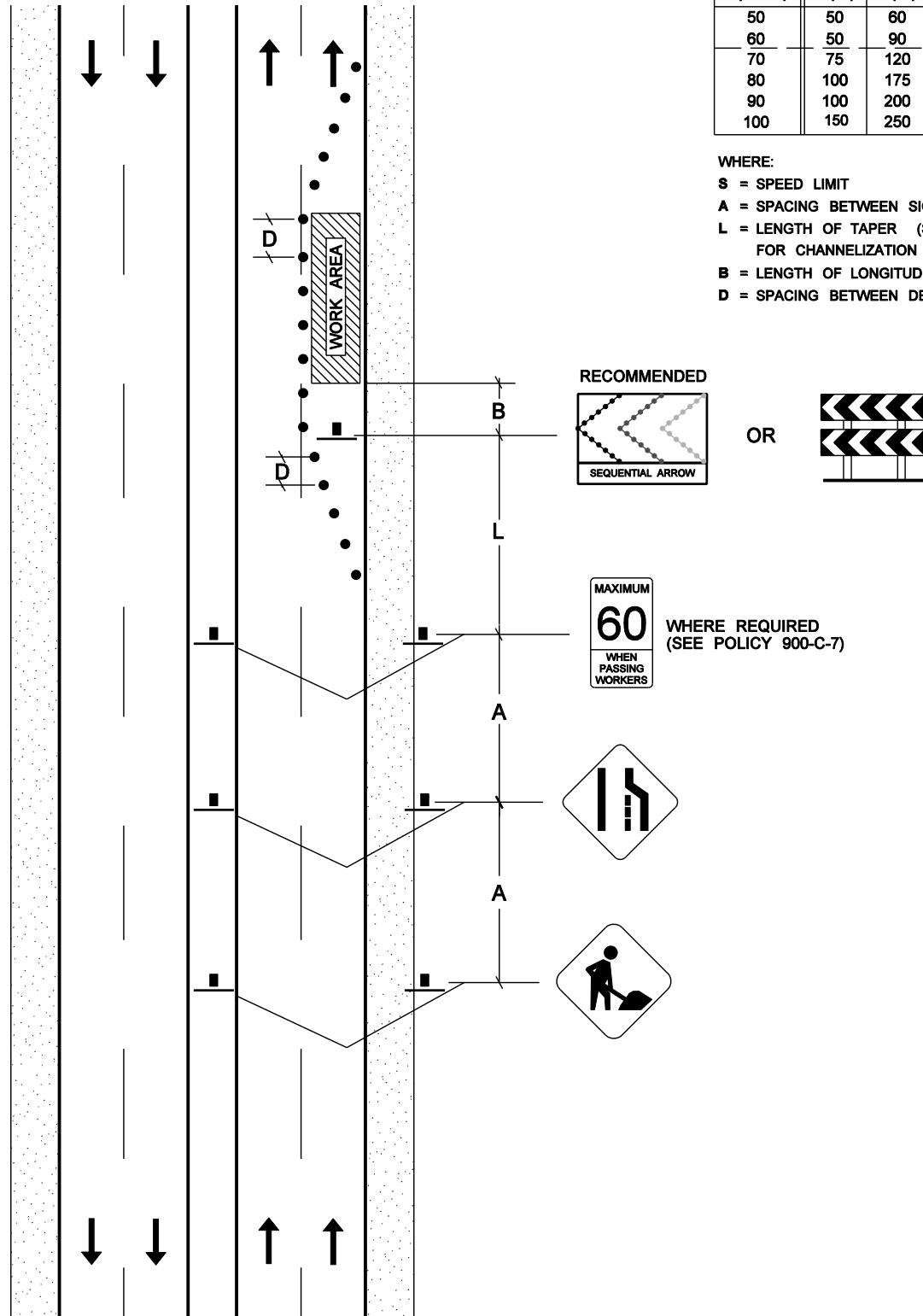

RECOMMENDED



OR

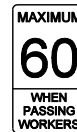
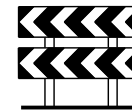

WHERE REQUIRED
 (SEE POLICY 900-C-7)



SINGLE LANE CLOSED

MULTI-LANE ROAD - LEFT LANE CLOSED

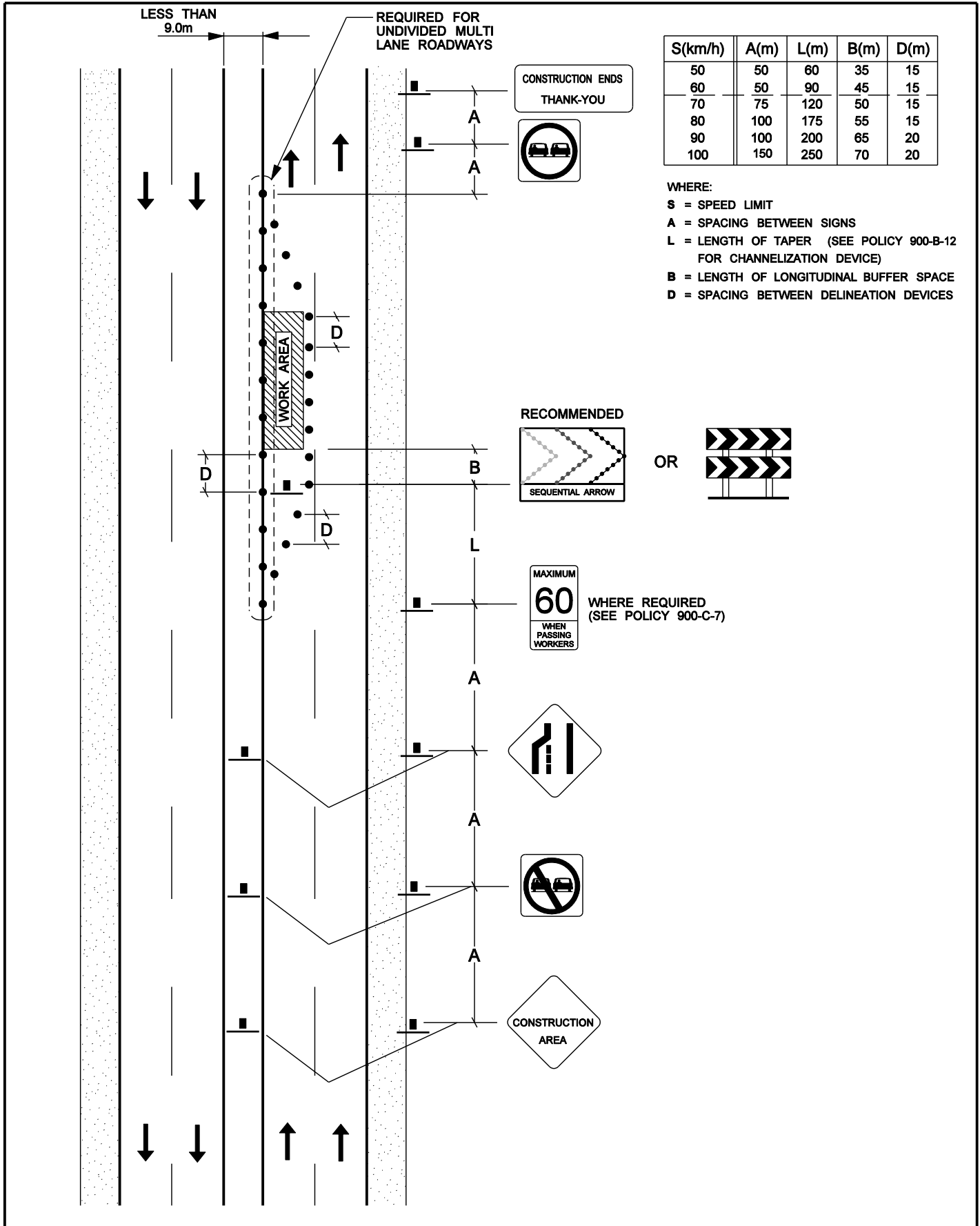

SINGLE LANE CLOSED

MULTI-LANE ROAD - RIGHT LANE CLOSED

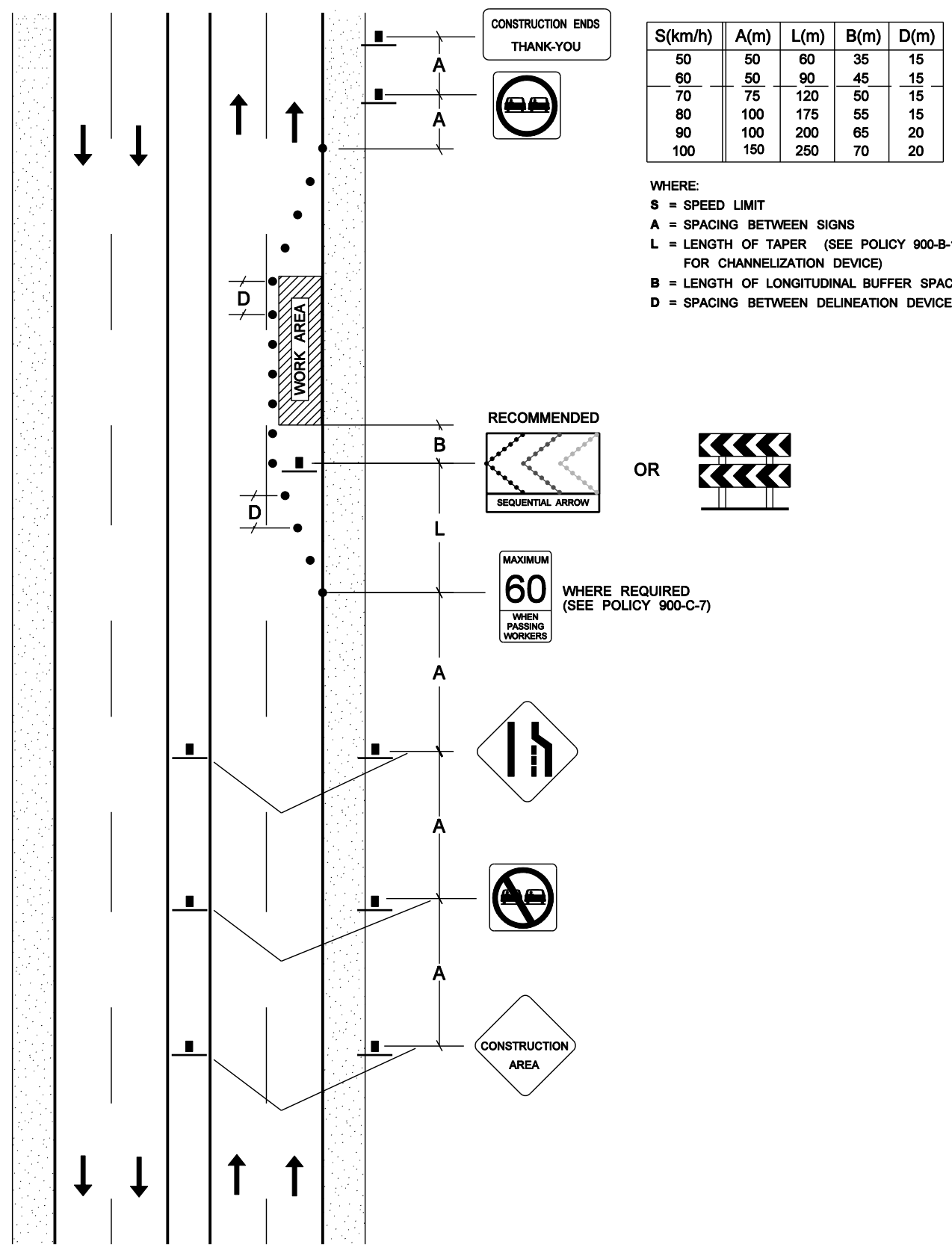

S(km/h)	A(m)	L(m)	B(m)	D(m)
50	50	60	35	15
60	50	90	45	15
70	75	120	50	15
80	100	175	55	15
90	100	200	65	20
100	150	250	70	20

WHERE:
S = SPEED LIMIT
A = SPACING BETWEEN SIGNS
L = LENGTH OF TAPER (SEE POLICY 900-B-12 FOR CHANNELIZATION DEVICE)
B = LENGTH OF LONGITUDINAL BUFFER SPACE
D = SPACING BETWEEN DELINEATION DEVICES

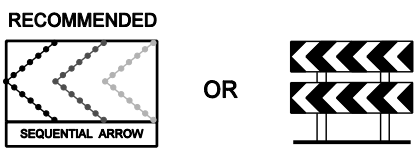

MAXIMUM
60
 WHEN PASSING WORKERS
 WHERE REQUIRED (SEE POLICY 900-C-7)

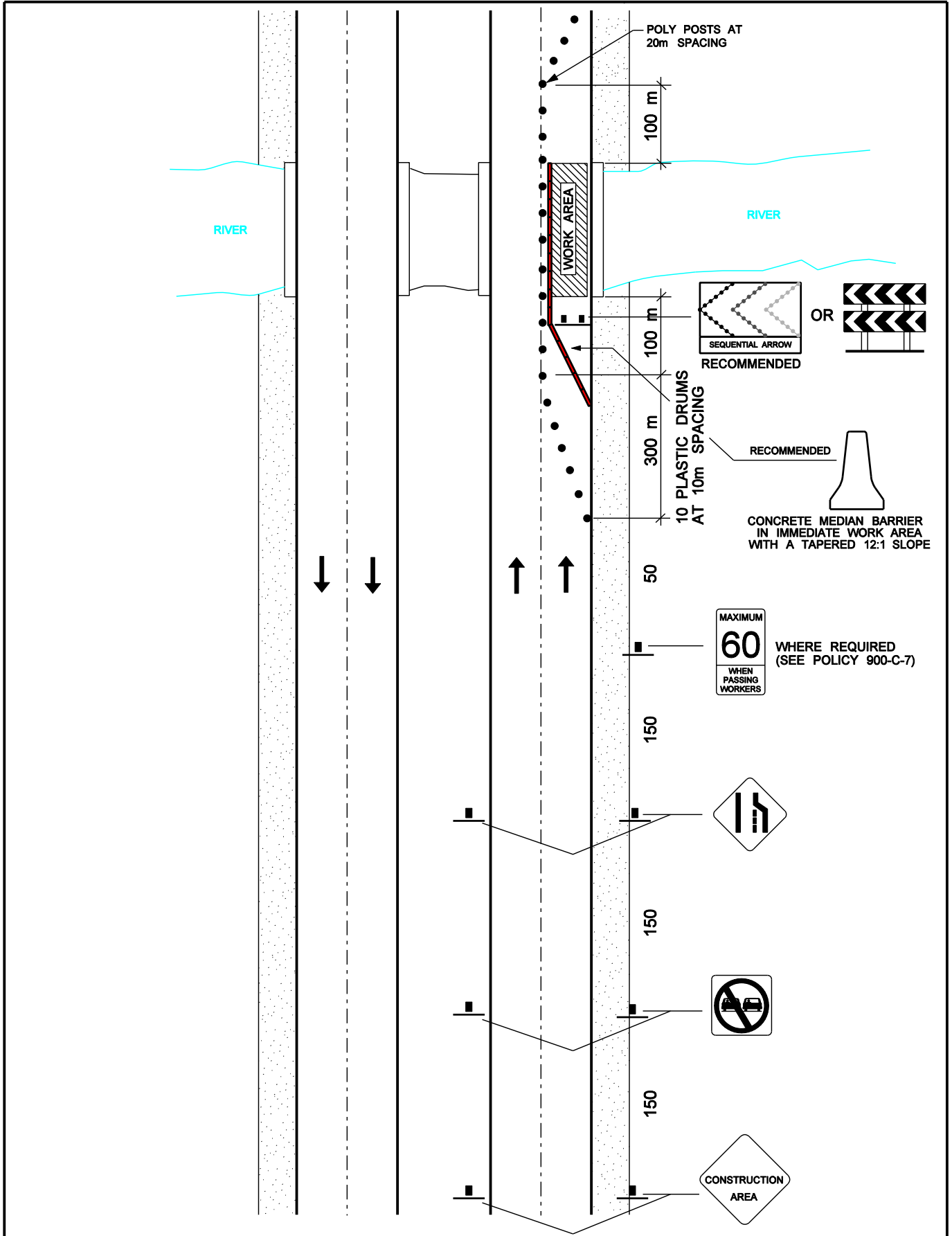

INTERSECTION LANE CLOSURES ON TWO-LANE ROADS

NEARSIDE LANE CLOSURE

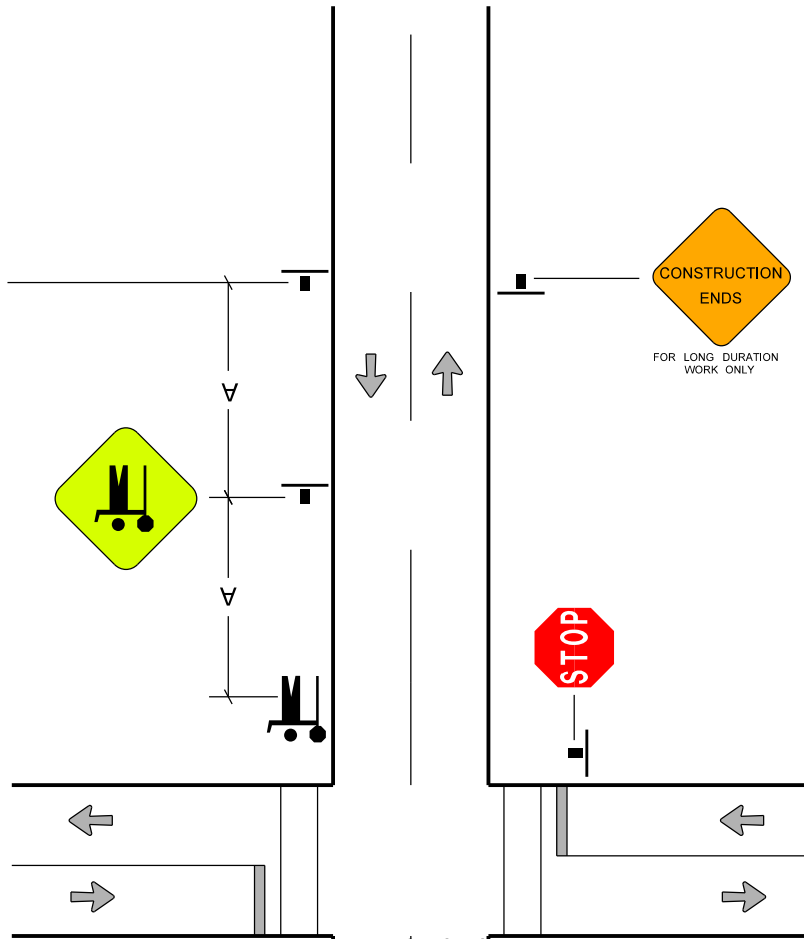

S(km/h)	A(m)	L(m)	B(m)	D(m)
50	50	60	35	15
60	50	90	45	15
70	75	120	50	15
80	100	175	55	15
90	100	200	65	20
100	150	250	70	20

WHERE:
S = SPEED LIMIT
A = SPACING BETWEEN SIGNS
L = LENGTH OF TAPER (SEE POLICY 900-B-12)
 CHANNELIZATION BARRELS RECOMMENDED
B = LENGTH OF LONGITUDINAL BUFFER SPACE
D = SPACING BETWEEN DELINEATION DEVICES

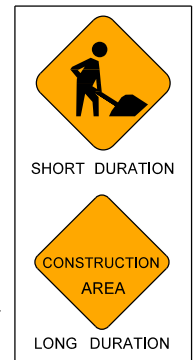

INTERSECTION LANE CLOSURES ON TWO-LANE ROADS

FARSIDE LANE CLOSURE



10m MAX.

30m MAX.



WORK AREA

S(km/h)	A(m)	L(m)	B(m)	D(m)
50	50	60	35	15
60	50	90	45	15
70	75	120	50	15
80	100	175	55	15
90	100	200	65	20
100	150	250	70	20

WHERE:

- S = SPEED LIMIT
- A = SPACING BETWEEN SIGNS
- L = LENGTH OF TAPER (SEE POLICY 900-B-12)
CHANNELIZATION BARRELS RECOMMENDED
- B = LENGTH OF LONGITUDINAL BUFFER SPACE
- D = SPACING BETWEEN DELINEATION DEVICES

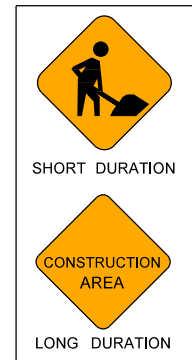

LEFT LANE CLOSURE

S(km/h)	A(m)	L(m)	B(m)	D(m)
50	50	60	35	15
60	50	90	45	15
70	75	120	50	15
80	100	175	55	15
90	100	200	65	20
100	150	250	70	20

WHERE:

S = SPEED LIMIT

A = SPACING BETWEEN SIGNS

L = LENGTH OF TAPER (SEE POLICY 900-B-12 FOR CHANNELIZATION DEVICE)

B = LENGTH OF LONGITUDINAL BUFFER SPACE

D = SPACING BETWEEN DELINEATION DEVICES

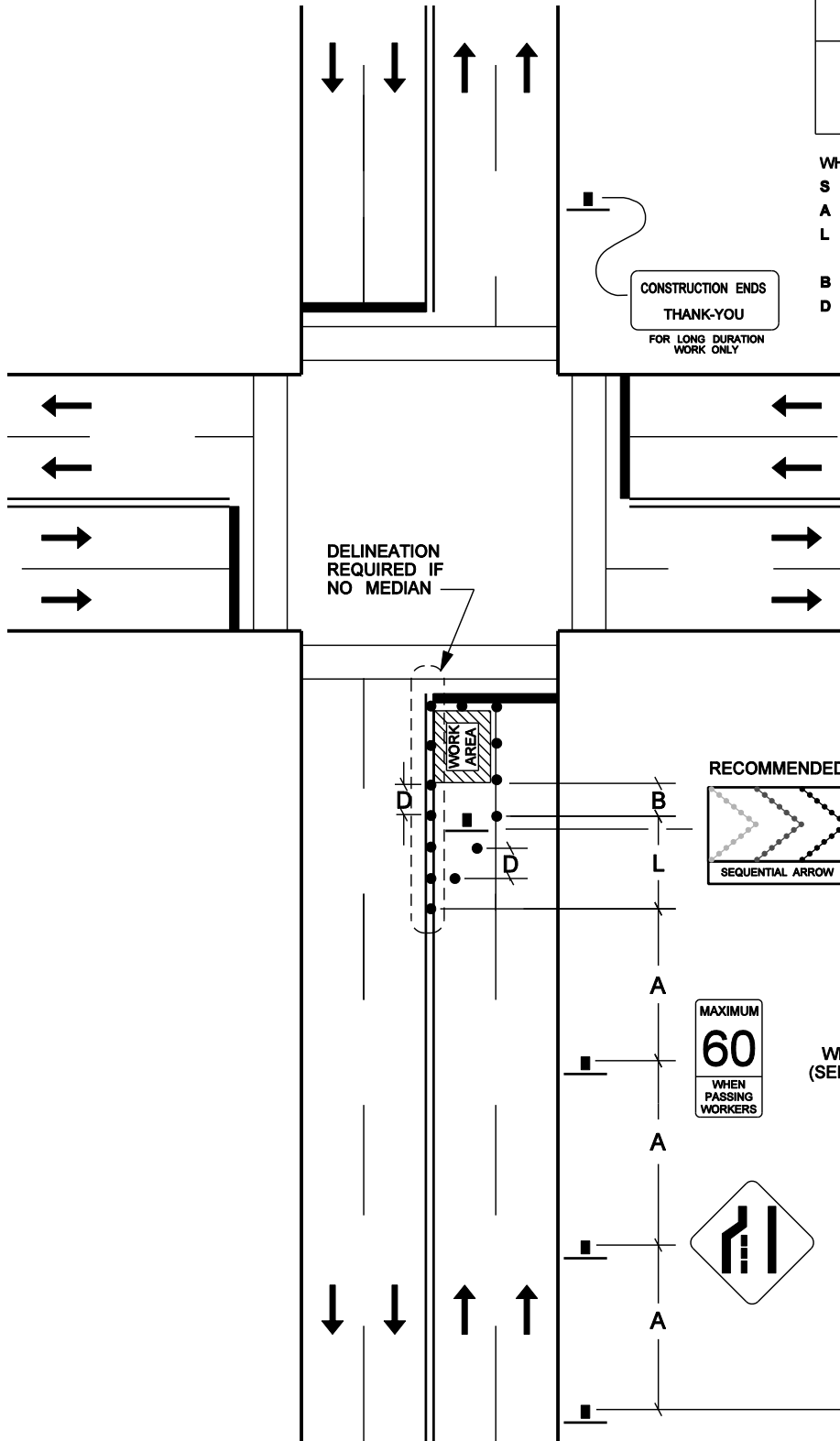

RECOMMENDED

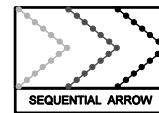

OR

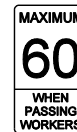
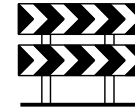

WHERE REQUIRED
 (SEE POLICY 900-C-7)



SHORT DURATION



LONG DURATION

RIGHT LANE CLOSURE

S(km/h)	A(m)	L(m)	B(m)	D(m)
50	50	60	35	15
60	50	90	45	15
70	75	120	50	15
80	100	175	55	15
90	100	200	65	20
100	150	250	70	20

WHERE:

S = SPEED LIMIT

A = SPACING BETWEEN SIGNS

L = LENGTH OF TAPER (SEE POLICY 900-B-12 FOR CHANNELIZATION DEVICE)

B = LENGTH OF LONGITUDINAL BUFFER SPACE

D = SPACING BETWEEN DELINEATION DEVICES

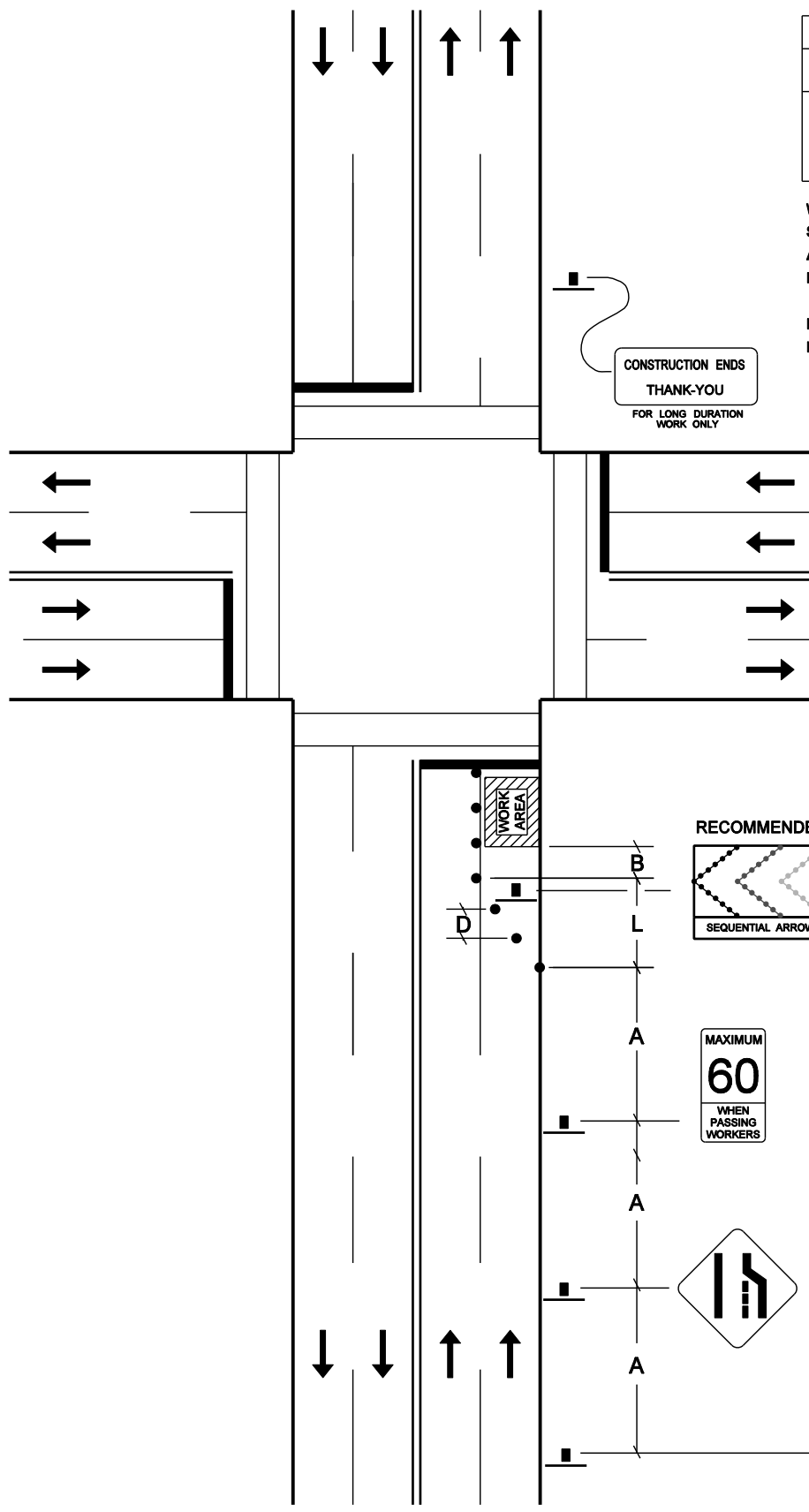

RECOMMENDED

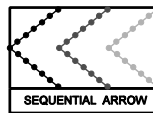

OR

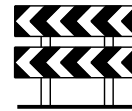

WHERE REQUIRED (SEE POLICY 900-C-7)

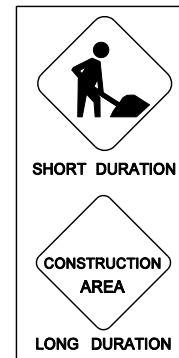
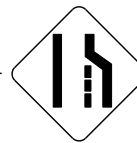
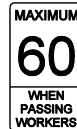

RIGHT-TURN LANE CLOSED

S(km/h)	A(m)	L(m)	B(m)	D(m)
50	50	60	35	15
60	50	90	45	15
70	75	120	50	15
80	100	175	55	15
90	100	200	65	20
100	150	250	70	20

WHERE:

S = SPEED LIMIT

A = SPACING BETWEEN SIGNS

L = LENGTH OF TAPER (SEE POLICY 900-B-12 FOR CHANNELIZATION DEVICE)

B = LENGTH OF LONGITUDINAL BUFFER SPACE

D = SPACING BETWEEN DELINEATION DEVICES

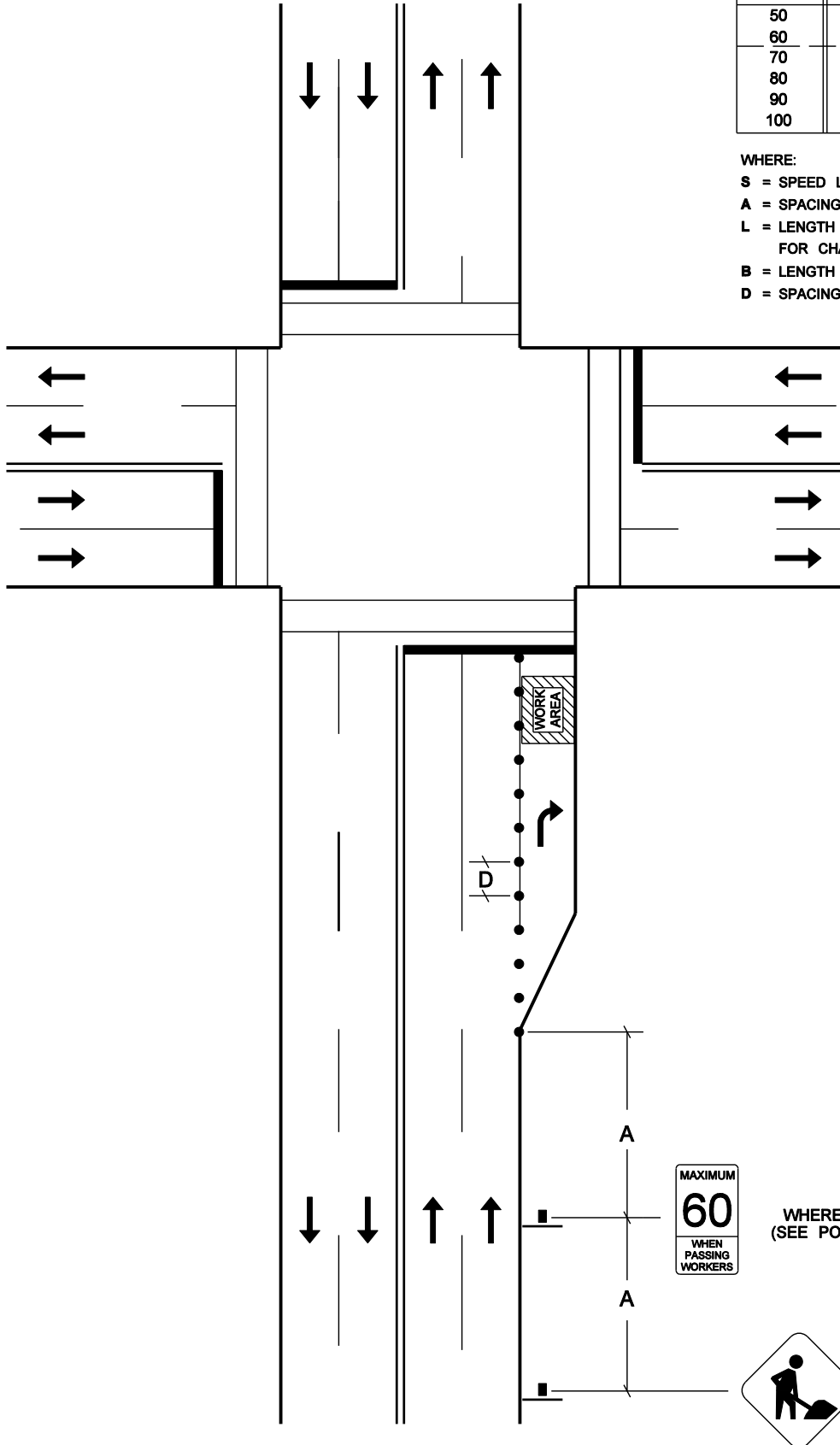

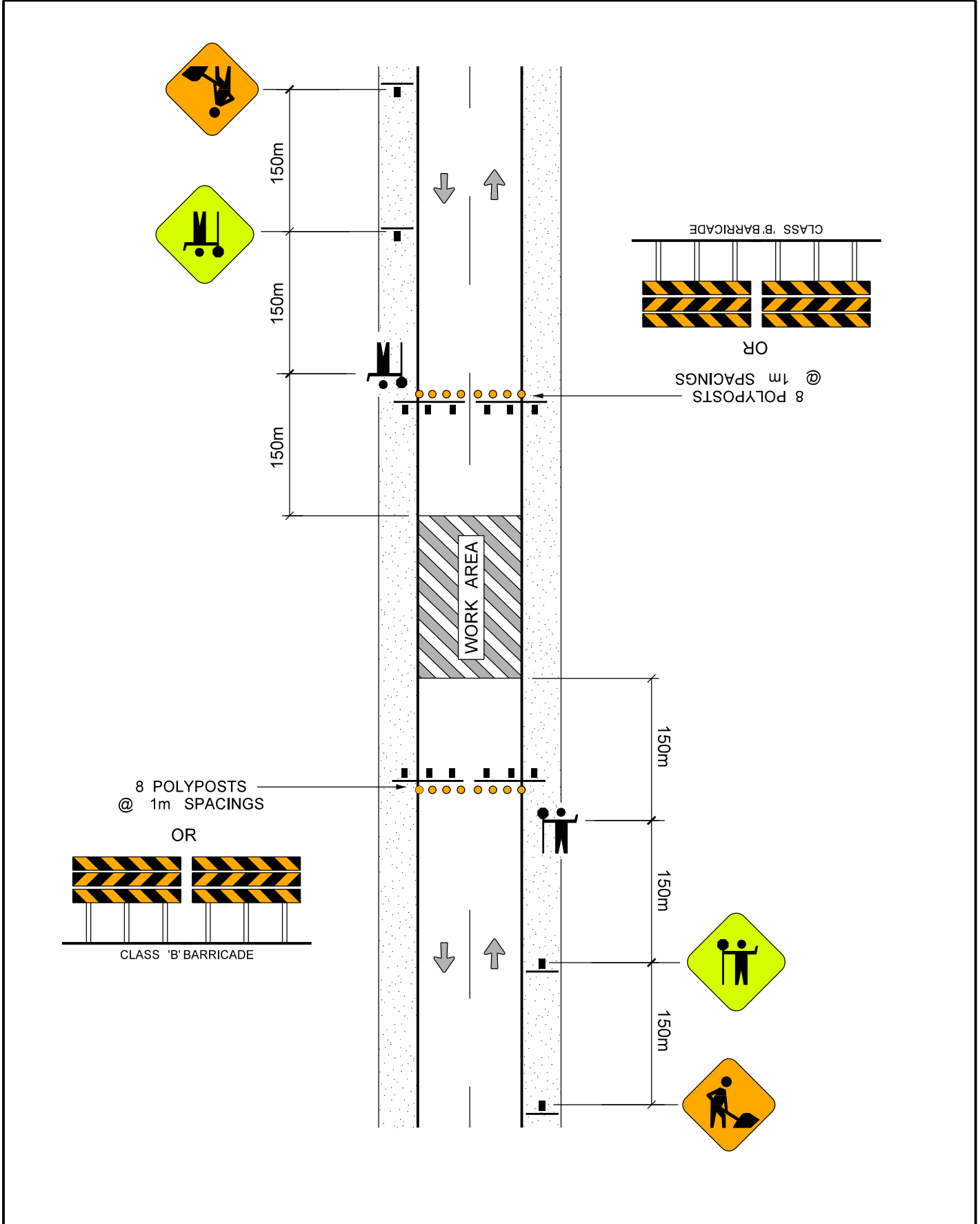

AREAS IN THE WORK ZONE

SHOOFLY DETOUR - SHORT TERM

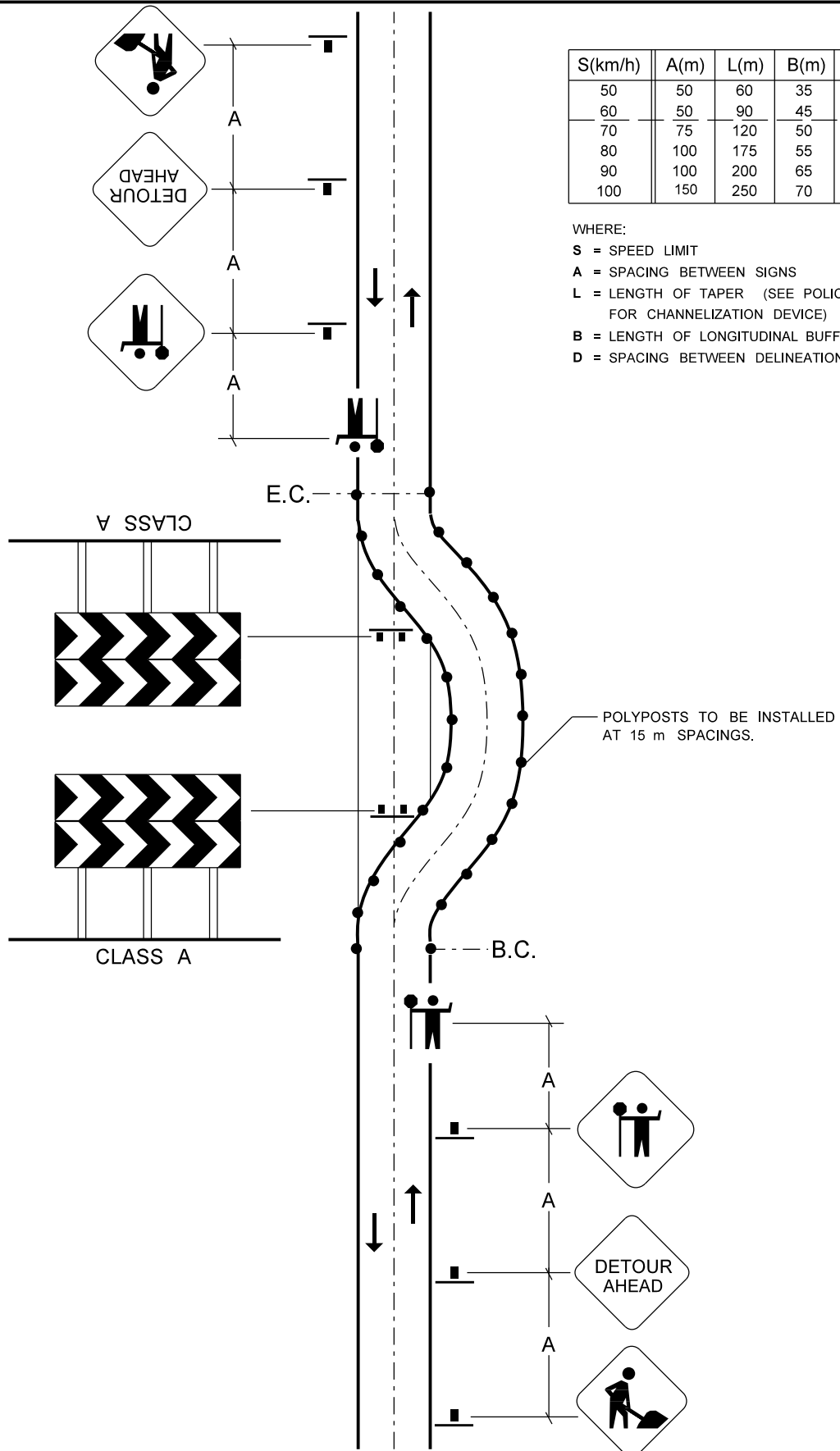

S(km/h)	A(m)	L(m)	B(m)	D(m)
50	50	60	35	15
60	50	90	45	15
70	75	120	50	15
80	100	175	55	15
90	100	200	65	20
100	150	250	70	20

WHERE:
 S = SPEED LIMIT
 A = SPACING BETWEEN SIGNS
 L = LENGTH OF TAPER (SEE POLICY 900-B-12 FOR CHANNELIZATION DEVICE)
 B = LENGTH OF LONGITUDINAL BUFFER SPACE
 D = SPACING BETWEEN DELINEATION DEVICES

AREAS IN THE WORK ZONE

BUMP DUE TO CONSTRUCTION - SHORT TERM

ADVISORY SPEED TAB
 DEPENDANT ON SEVERITY
 OF BUMP

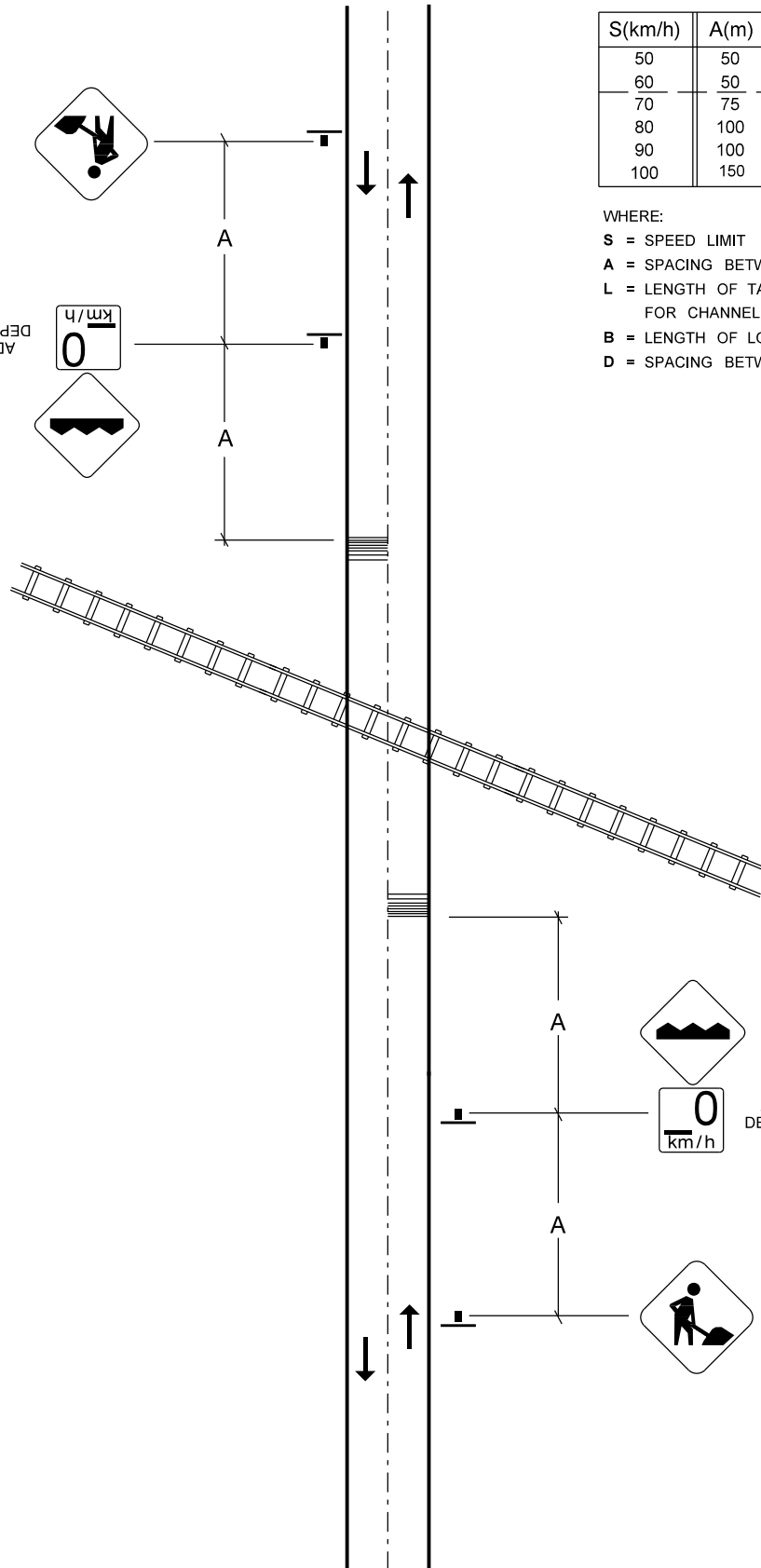

S(km/h)	A(m)	L(m)	B(m)	D(m)
50	50	60	35	15
60	50	90	45	15
70	75	120	50	15
80	100	175	55	15
90	100	200	65	20
100	150	250	70	20

WHERE:

S = SPEED LIMIT

A = SPACING BETWEEN SIGNS

L = LENGTH OF TAPER (SEE POLICY 900-B-12 FOR CHANNELIZATION DEVICE)

B = LENGTH OF LONGITUDINAL BUFFER SPACE

D = SPACING BETWEEN DELINEATION DEVICES

ADVISORY SPEED TAB
 DEPENDANT ON SEVERITY
 OF BUMP

AREAS IN THE WORK ZONE

SHOOFLY DETOUR

NOTE:
TRAFFIC SIGNING IS
SIMILAR FOR OPPOSING
DIRECTION.

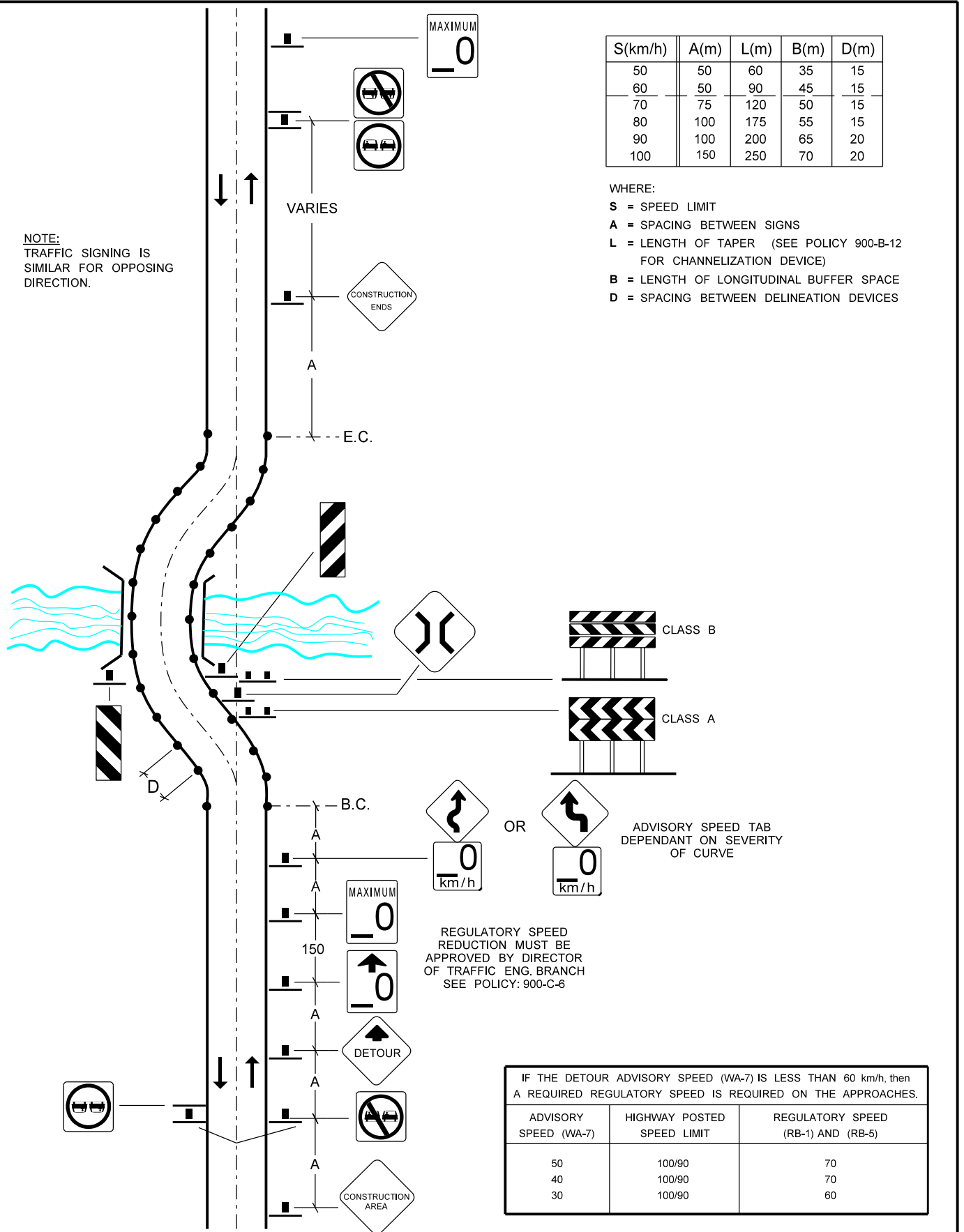

AREAS IN THE WORK ZONE

NARROW SHOOFLY DETOUR - LOW VOLUME < 60 VEHICLES/DAY

NOTE:
TRAFFIC SIGNING IS
SIMILAR FOR OPPOSING
DIRECTION.

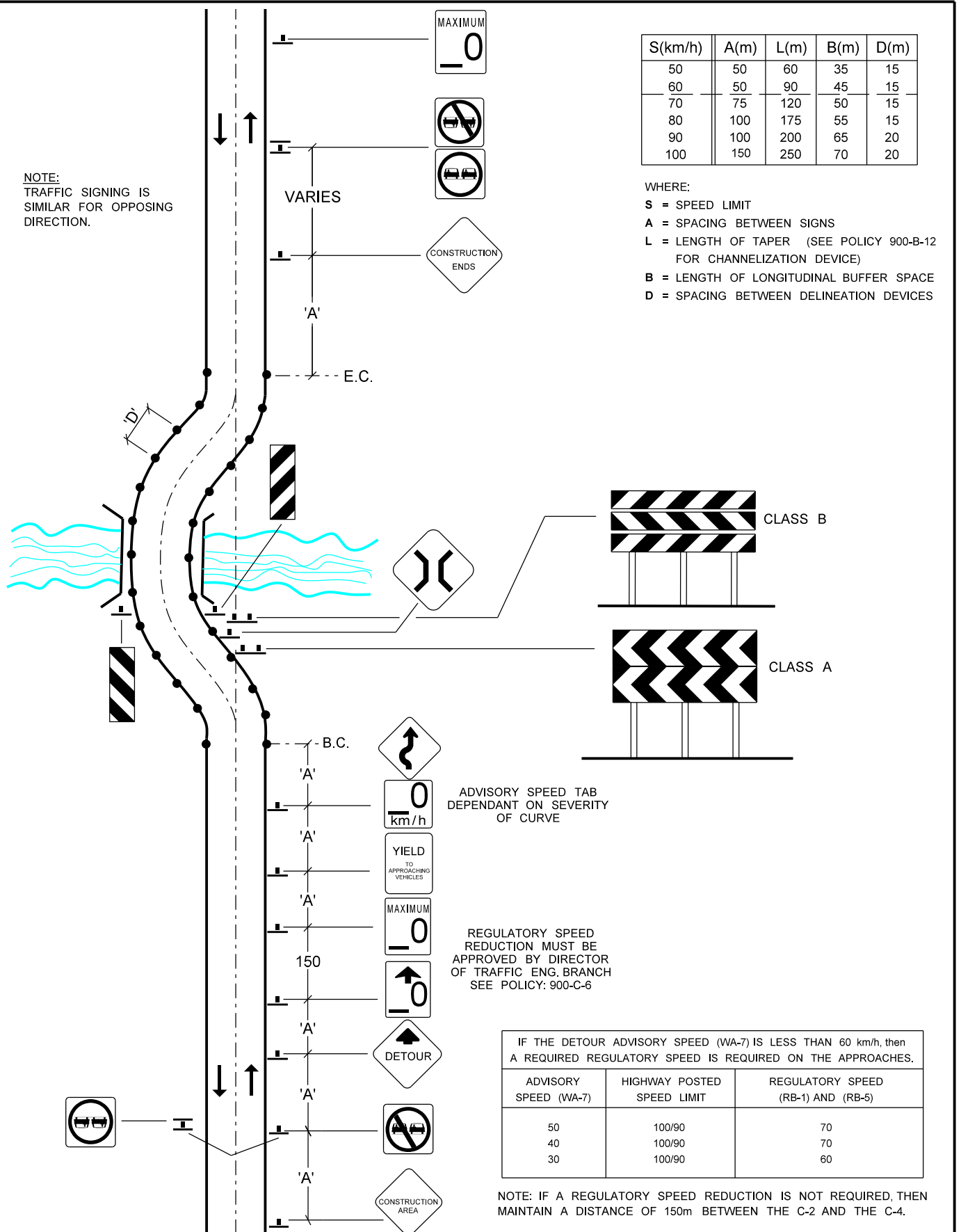

S(km/h)	A(m)	L(m)	B(m)	D(m)
50	50	60	35	15
60	50	90	45	15
70	75	120	50	15
80	100	175	55	15
90	100	200	65	20
100	150	250	70	20

WHERE:

S = SPEED LIMIT

A = SPACING BETWEEN SIGNS

L = LENGTH OF TAPER (SEE POLICY 900-B-12 FOR CHANNELIZATION DEVICE)

B = LENGTH OF LONGITUDINAL BUFFER SPACE

D = SPACING BETWEEN DELINEATION DEVICES

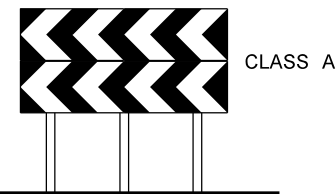
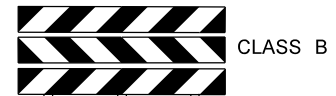

ADVISORY SPEED TAB
DEPENDANT ON SEVERITY
OF CURVE

REGULATORY SPEED
REDUCTION MUST BE
APPROVED BY DIRECTOR
OF TRAFFIC ENG. BRANCH
SEE POLICY: 900-C-6

IF THE DETOUR ADVISORY SPEED (WA-7) IS LESS THAN 60 km/h, then A REQUIRED REGULATORY SPEED IS REQUIRED ON THE APPROACHES.

ADVISORY SPEED (WA-7)	HIGHWAY POSTED SPEED LIMIT	REGULATORY SPEED (RB-1) AND (RB-5)
50	100/90	70
40	100/90	70
30	100/90	60

NOTE: IF A REGULATORY SPEED REDUCTION IS NOT REQUIRED, THEN MAINTAIN A DISTANCE OF 150m BETWEEN THE C-2 AND THE C-4.

AREAS IN THE WORK ZONE

4 - LANE DIVIDED HIGHWAY CONVERSION TO 2 - LANE 2 - WAY

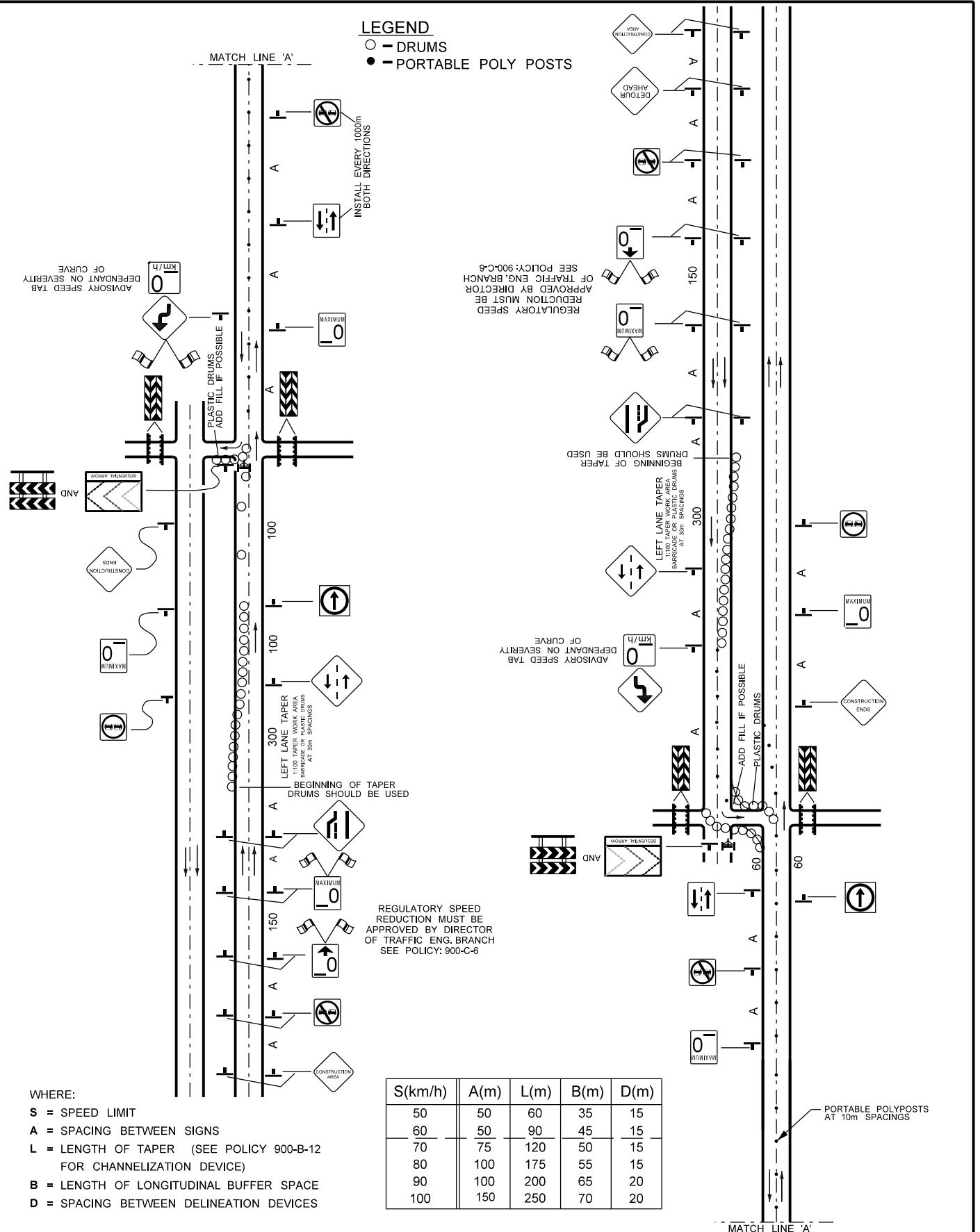

AREAS IN THE WORK ZONE

TRAFFIC CONTROL USING A PILOT VEHICLE

WHERE:

- S = SPEED LIMIT
- A = SPACING BETWEEN SIGNS
- L = LENGTH OF TAPER (SEE POLICY 900-B-12 FOR CHANNELIZATION DEVICE)
- B = LENGTH OF LONGITUDINAL BUFFER SPACE
- D = SPACING BETWEEN DELINEATION DEVICES

S(km/h)	A(m)	L(m)	B(m)	D(m)
50	50	60	35	15
60	50	90	45	15
70	75	120	50	15
80	100	175	55	15
90	100	200	65	20
100	150	250	70	20

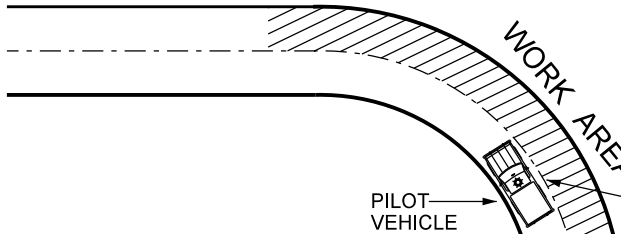
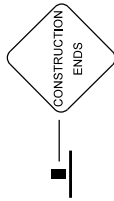

USE SIMILAR SIGNING LAYOUT FOR OPPOSING DIRECTION

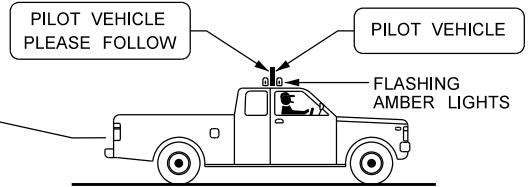

USE PILOT VEHICLE AS REQUIRED BY TRAFFIC VOLUME THROUGH THE ACTIVE WORK AREA.

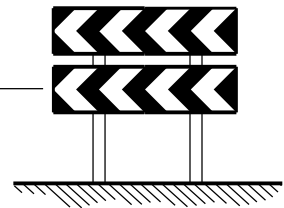

NOTE: FOR MOBILE FLAGMAN REFER TO FLAGMAN POLICY FOR HIGH VOLUME LARGE QUEUE.

APPROVED MESSAGES FOR VARIABLE MESSAGE SIGN:

FLAGMAN
AHEAD 2 km

PREPARE
TO STOP

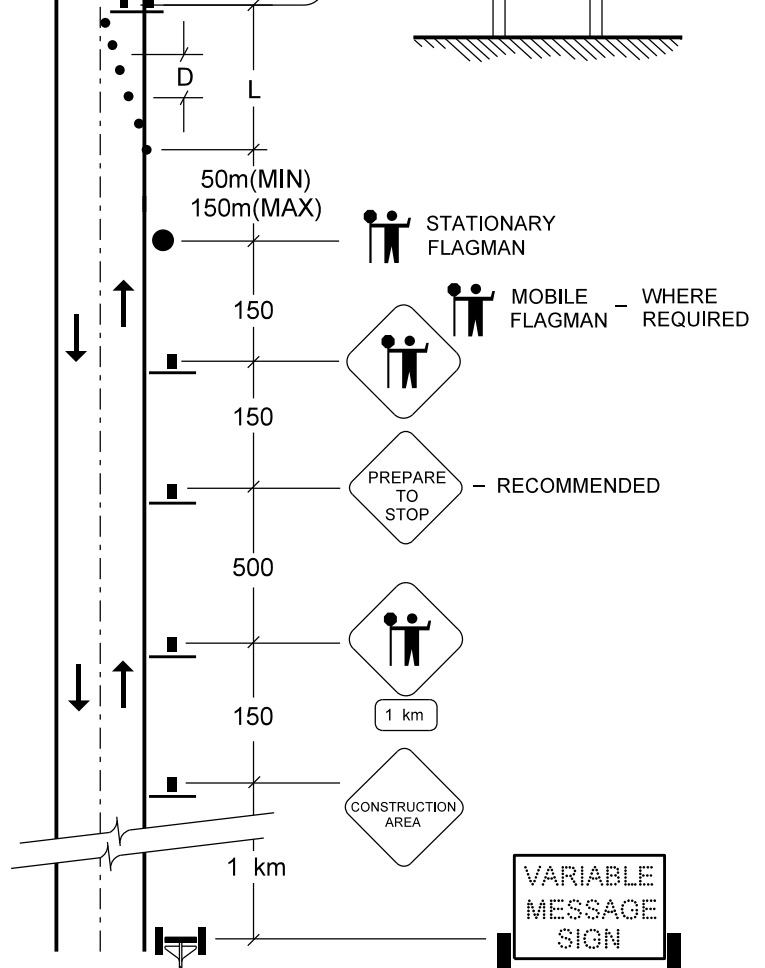

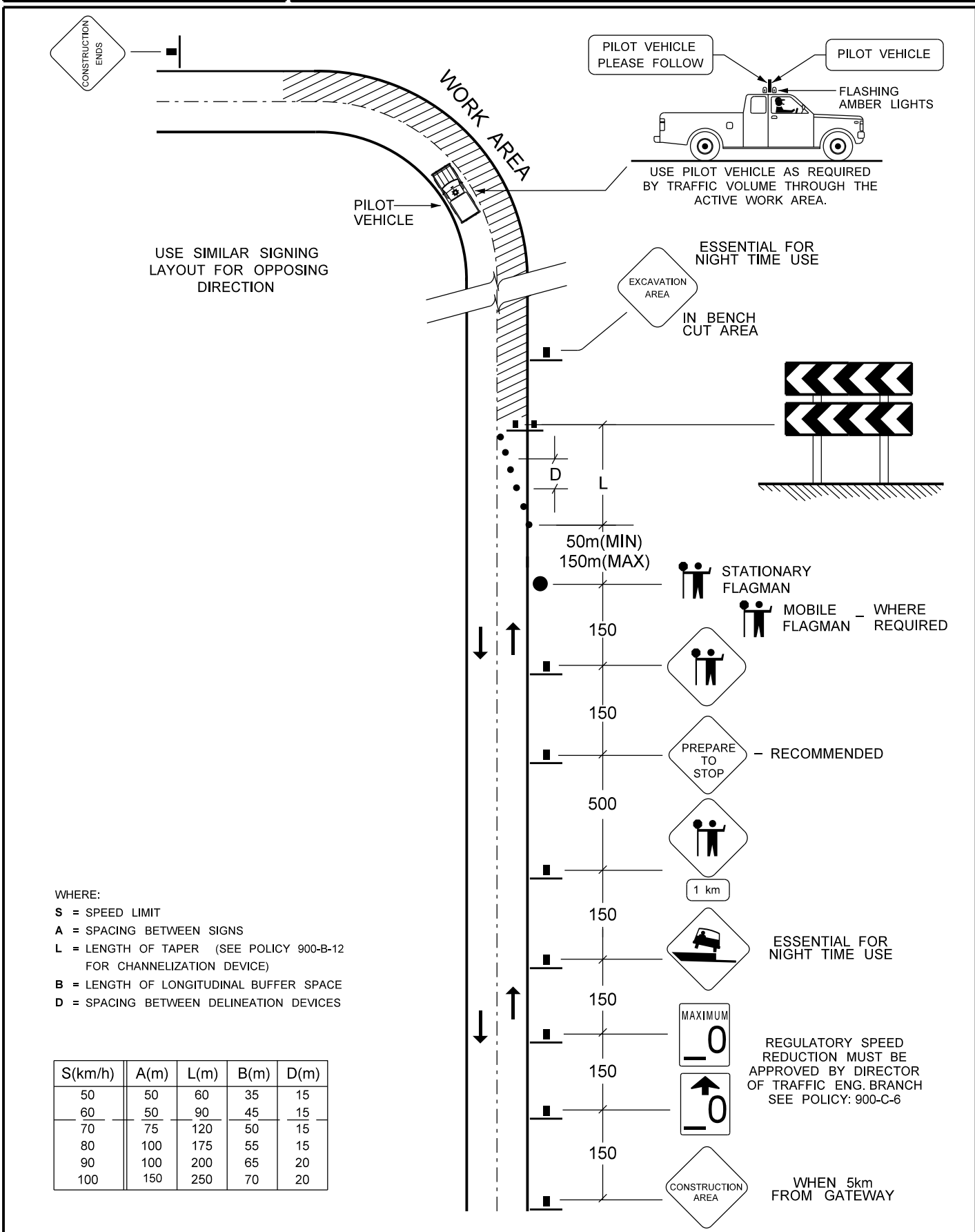

WHERE:
S = SPEED LIMIT
A = SPACING BETWEEN SIGNS
L = LENGTH OF TAPER (SEE POLICY 900-B-12 FOR CHANNELIZATION DEVICE)
B = LENGTH OF LONGITUDINAL BUFFER SPACE
D = SPACING BETWEEN DELINEATION DEVICES

S(km/h)	A(m)	L(m)	B(m)	D(m)
50	50	60	35	15
60	50	90	45	15
70	75	120	50	15
80	100	175	55	15
90	100	200	65	20
100	150	250	70	20

USE SIMILAR SIGNING LAYOUT FOR OPPOSING DIRECTION

HAZARDOUS AREAS MAY VARY CONSIDERABLY. EACH SITUATION SHALL BE SIGNED APPROPRIATELY AFTER CONSULTING WITH THE ENGINEER

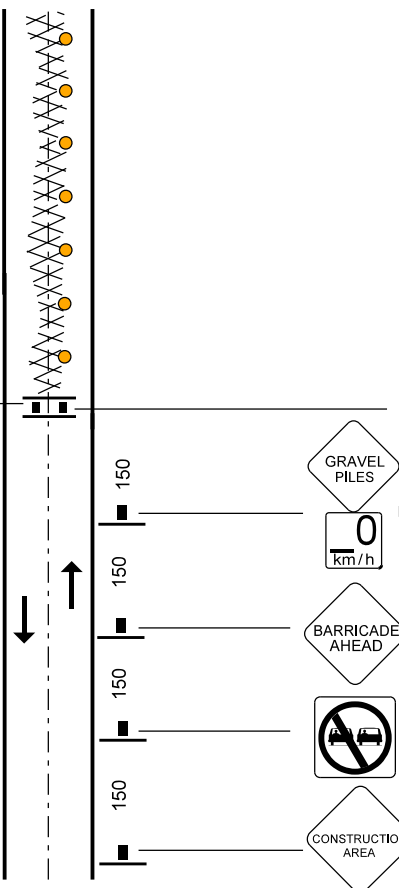
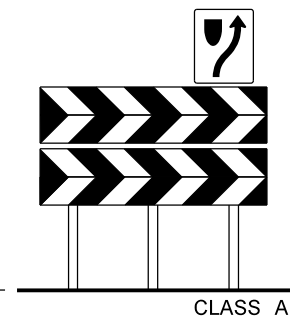
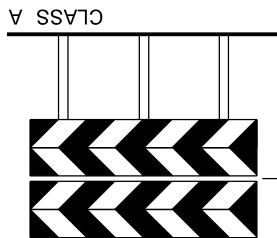
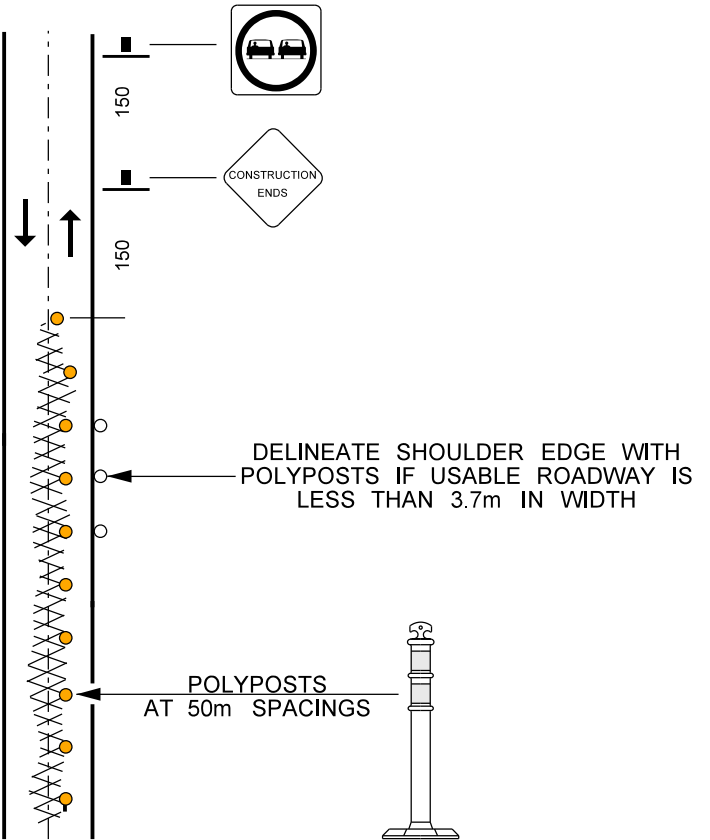

XXXXXXXXX GRAVEL PILED IN CENTRE OF HIGHWAY

ADVISORY SPEED TAB
DEPENDANT ON AVAILABLE
ROADWAY WIDTH

TYPICAL PAVING OPERATION

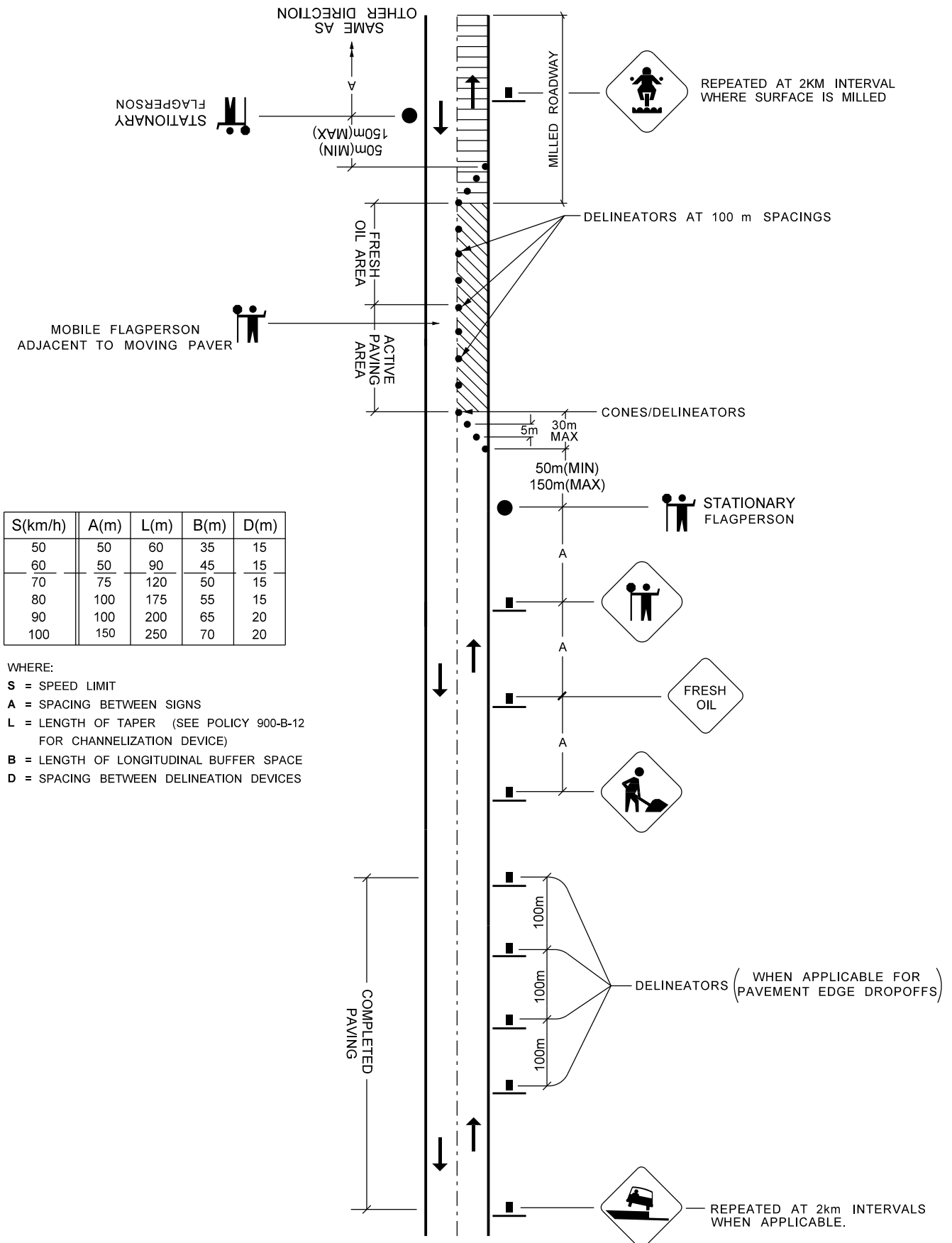

NOTE:
TRAFFIC SIGNING IS SIMILAR
FOR OPPOSING DIRECTION

APPROVED MESSAGES FOR
VARIABLE MESSAGE SIGN:

- CONST.
AHEAD
- EXPECT
DELAYS
- REDUCE
SPEED
- FLYING
STONES
- LOOSE
GRAVEL

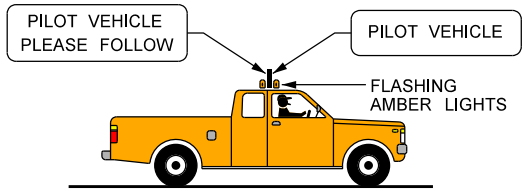

USE PILOT VEHICLE AS REQUIRED
ACCORDING TO TRAFFIC VOLUME
THROUGH THE ACTIVE WORK AREA.
(REFER TO 900-C-8)

APPROVED MESSAGES FOR
PILOT VEHICLE OPERATION:

- FLAGMAN
AHEAD
- PREPARE
TO STOP

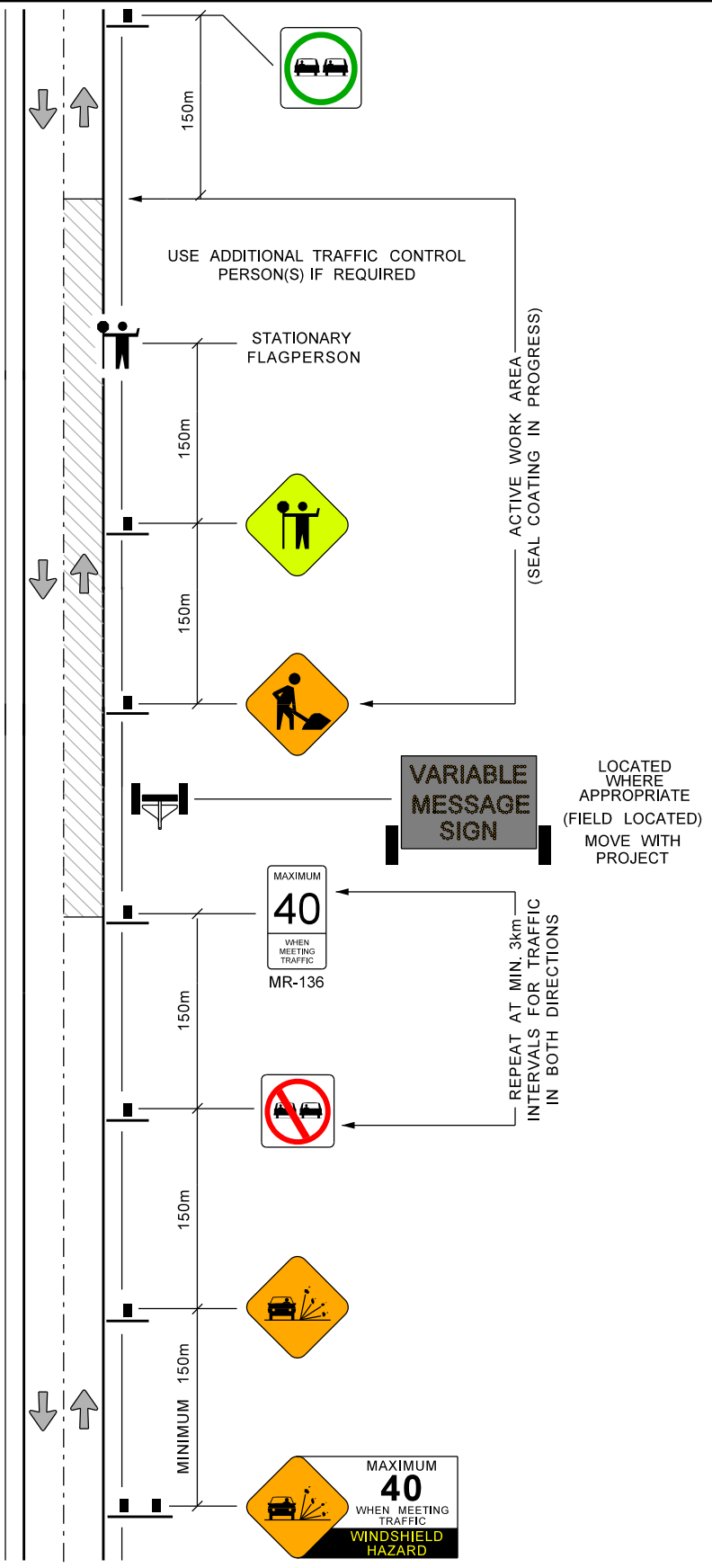

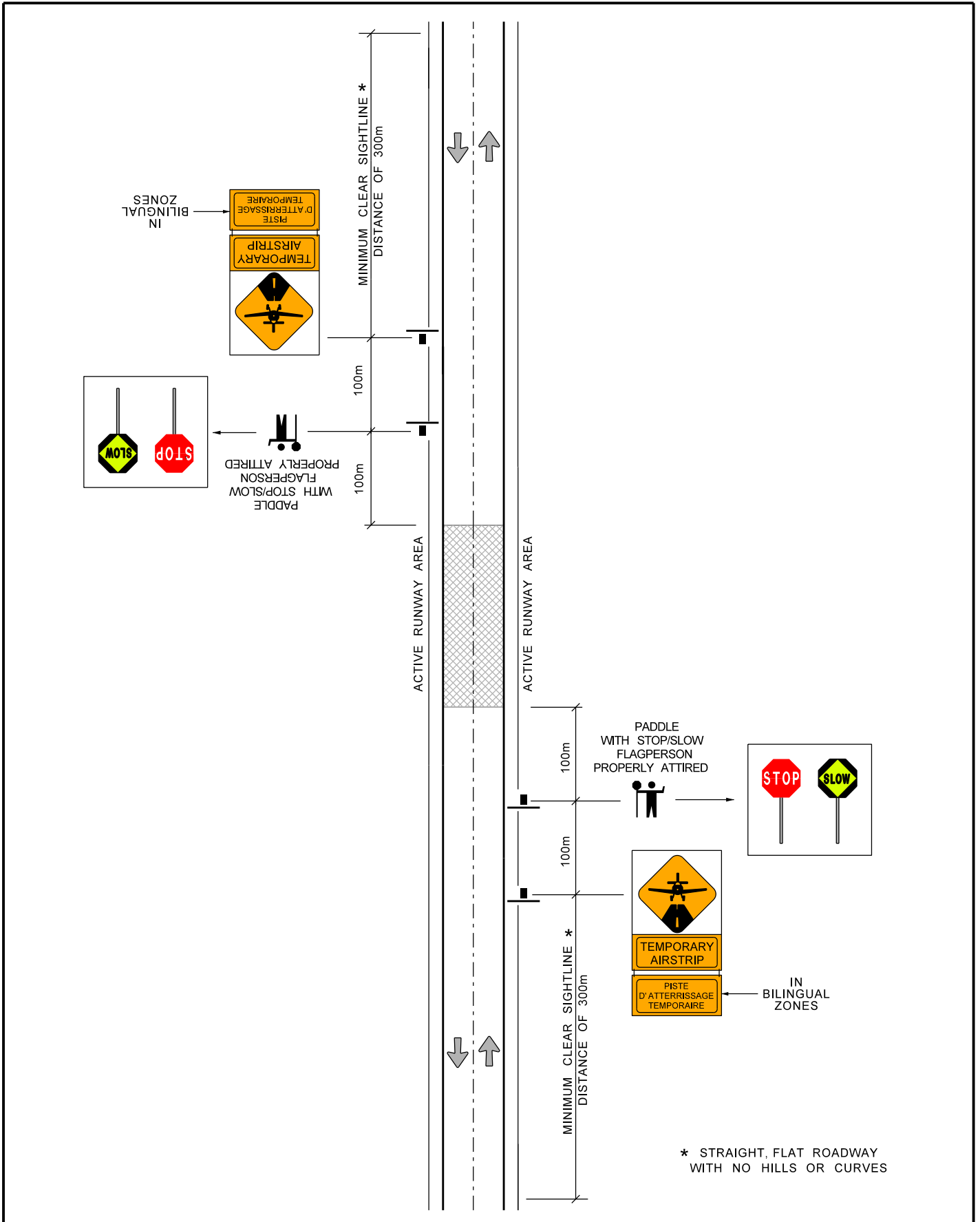

AREAS IN THE WORK ZONE

DAYTIME ONLY WORK

SHORT TERM JOINT REPAIR TRAFFIC CONTROL

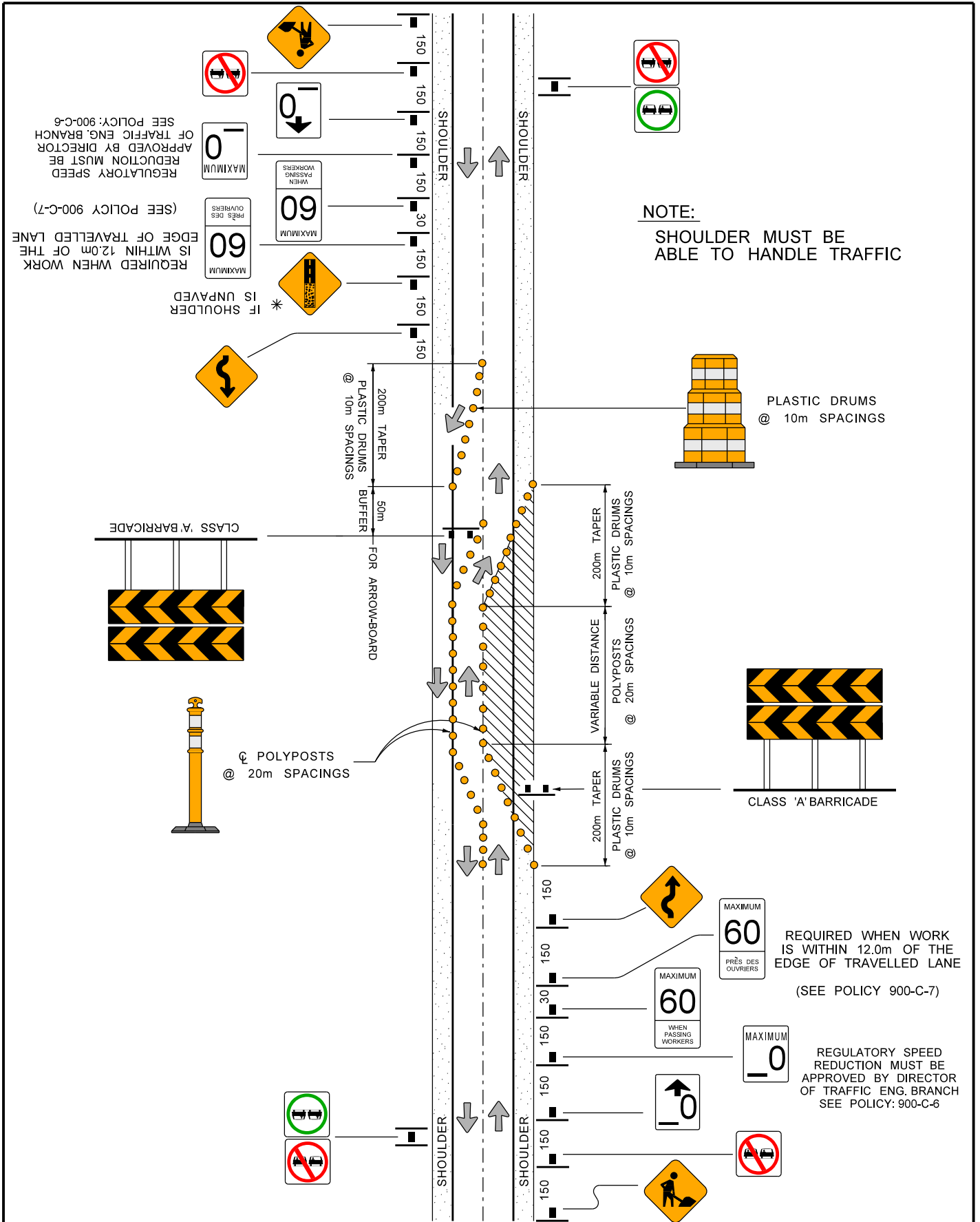

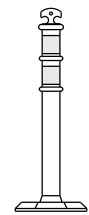

PORTABLE POLYPOSTS

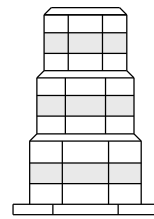

PLASTIC DRUM CHANNELIZERS

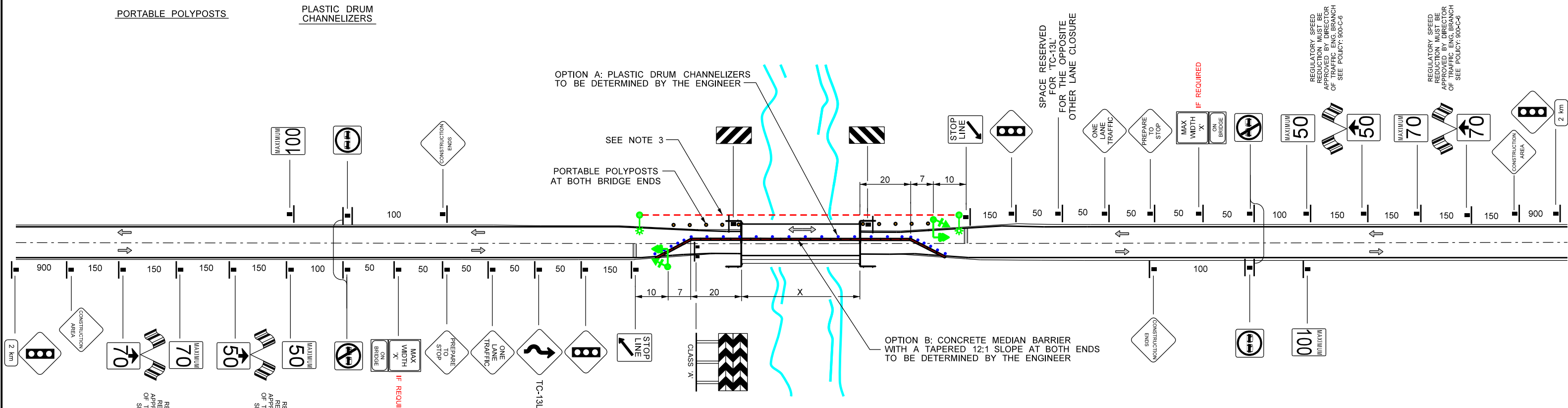

NOTE:

1. THIS STANDARD TO BE IMPLEMENTED WITH VOLUMES EXCEEDING 60 VEHICLES PER HOUR.
2. IF 'MAX WIDTH' SIGNS ARE REQUIRED AT BRIDGE, THEN SIGNS SHALL ALSO BE INSTALLED AT REMOTE LOCATIONS FOR ADVANCE WARNINGS.
3. ILLUMINATION SHALL BE REQUIRED ON EITHER SIDE OF THE BRIDGE TO A MAXIMUM 50m SPAN, CONFIRMED BY THE ENGINEER.
4. SIGN SPACING NOT TO SCALE.

DATE OF ISSUE: 2005-06; REVISED: 2010-07
PATH: TESIGNS/Te-020.dgn

APPROVED: **Glenn Cuthbertson P. Eng.**
DIRECTOR, TRAFFIC ENGINEERING BRANCH

TMP-32

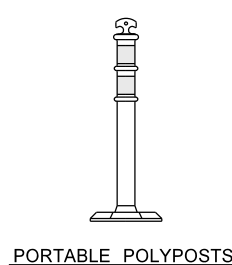

PORTABLE POLYPOSTS

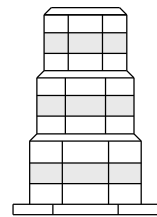

PLASTIC DRUM CHANNELIZERS

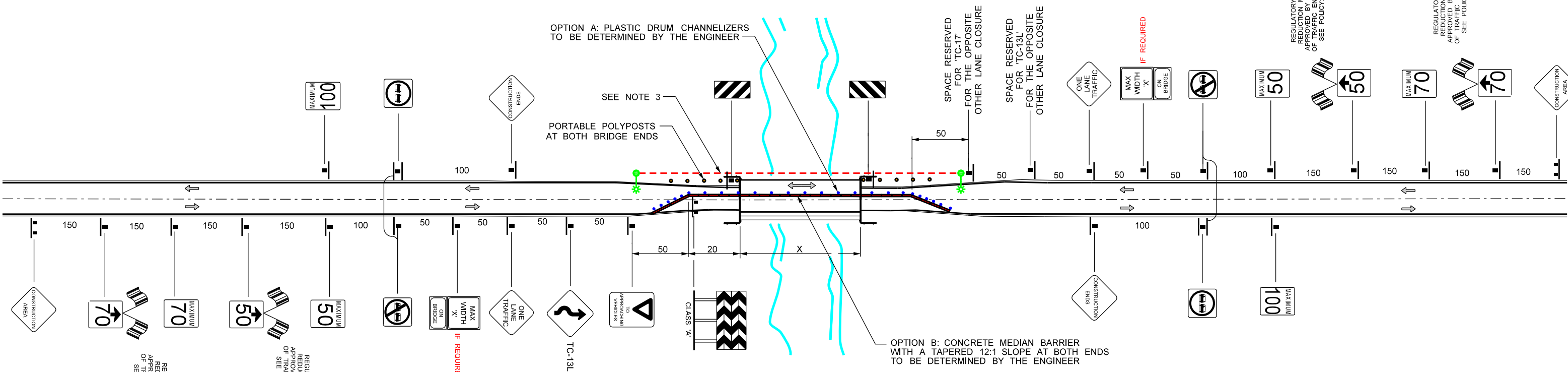

- NOTE:
- THIS STANDARD TO BE IMPLEMENTED WITH VOLUMES LESS THAN 60 VEHICLES PER HOUR.
 - IF 'MAX WIDTH' SIGNS ARE REQUIRED AT BRIDGE, THEN SIGNS SHALL ALSO BE INSTALLED AT REMOTE LOCATIONS FOR ADVANCE WARNINGS.
 - ILLUMINATION SHALL BE REQUIRED ON EITHER SIDE OF THE BRIDGE TO A MAXIMUM 50m SPAN, CONFIRMED BY THE ENGINEER.
 - SIGN SPACING NOT TO SCALE.

AREAS IN THE WORK ZONE

4 - LANE DIVIDED ROAD-WIDE TURNING TRUCKS "CONSTRUCTION ACCESS"

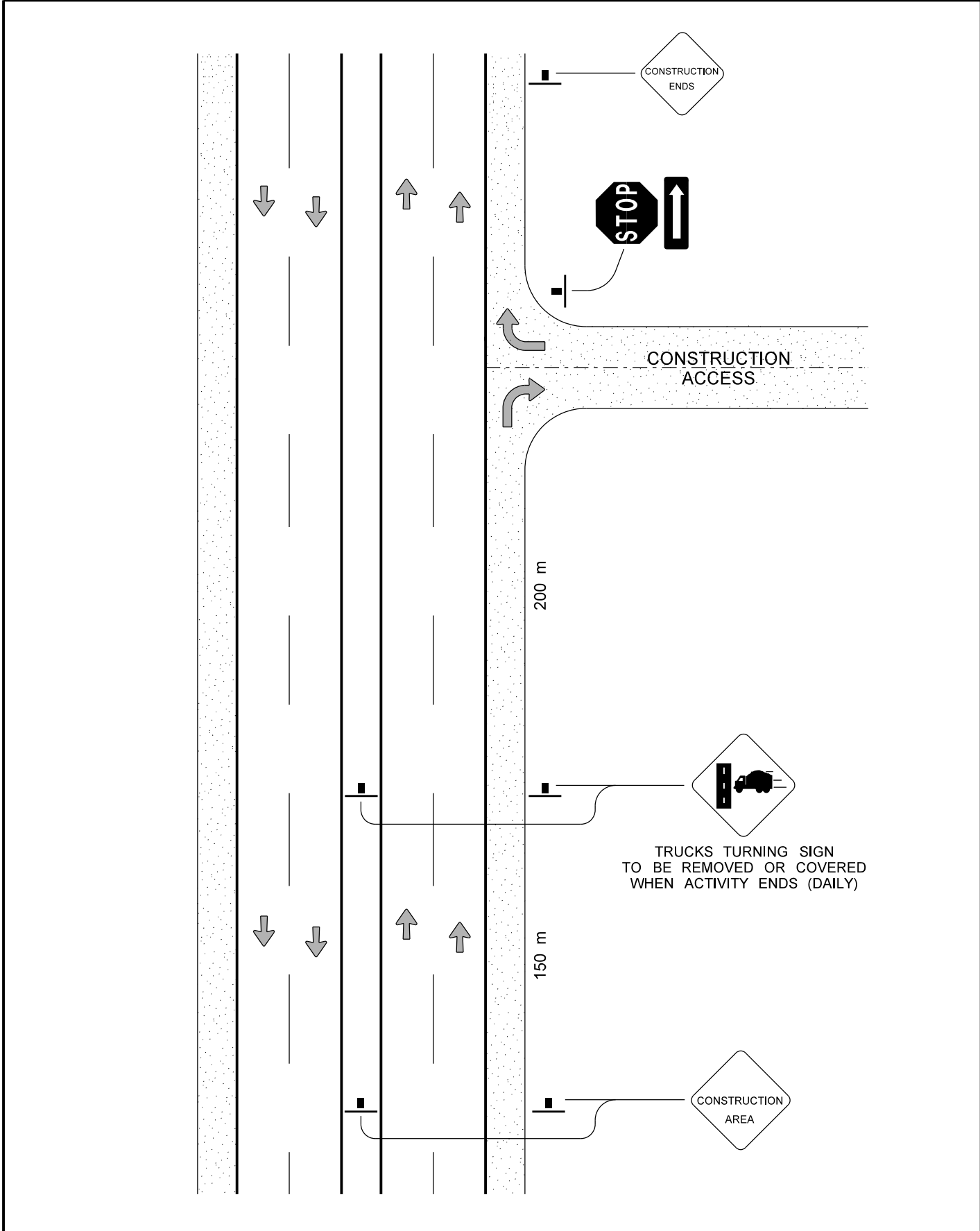

SINGLE LANE CLOSED ON TWO LANE ROAD

ROUTE AND SEAL OPERATION

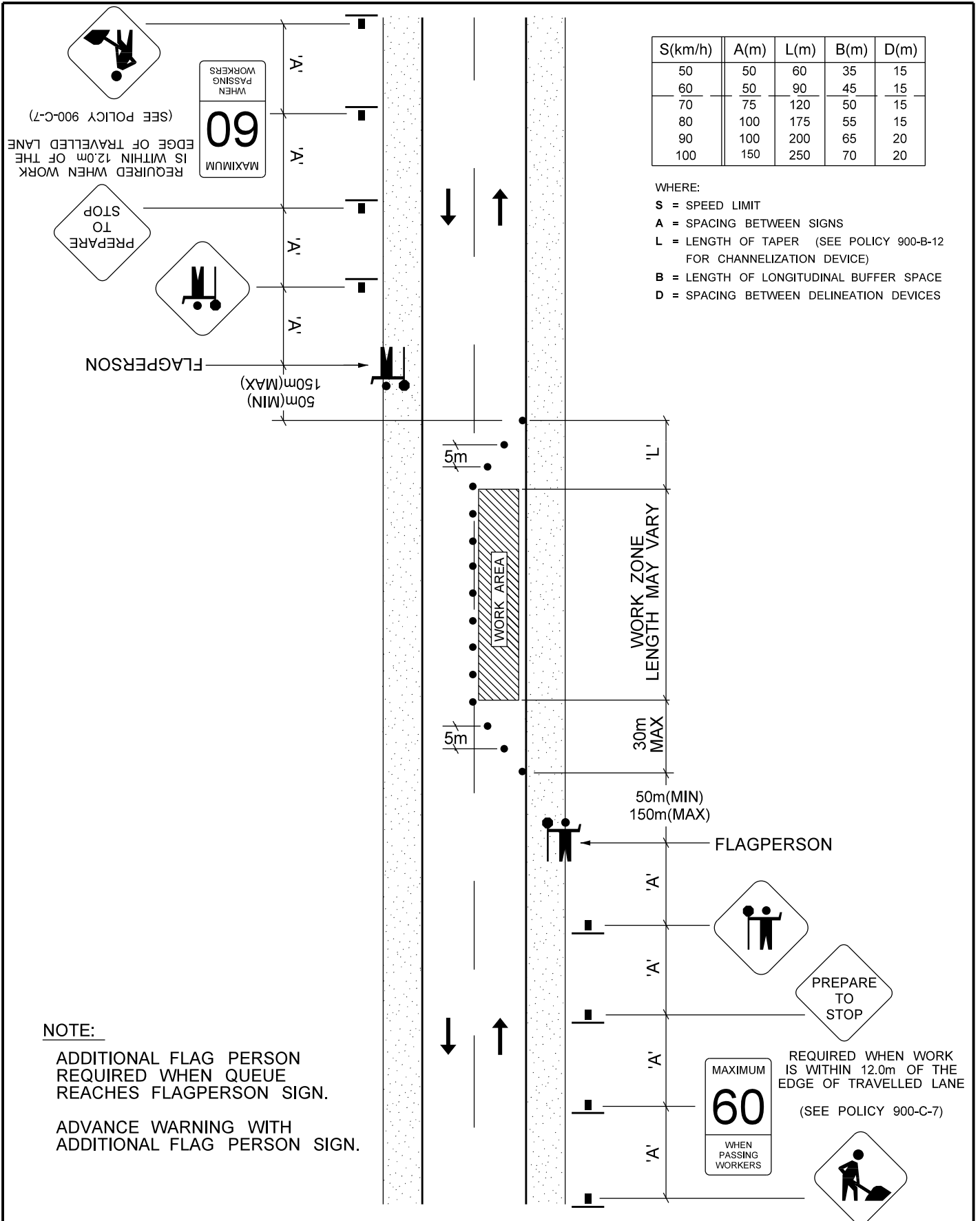

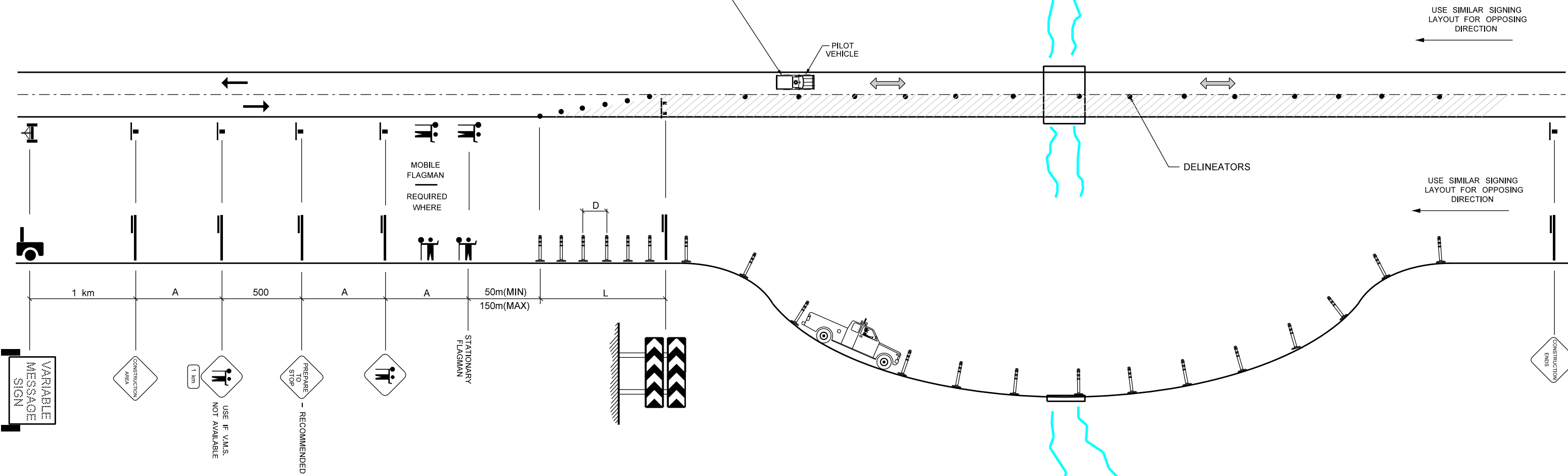
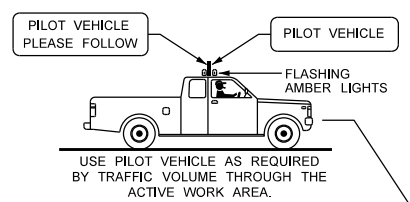

APPROVED MESSAGES FOR VARIABLE MESSAGE SIGN:

FLAGMAN AHEAD
PREPARE TO STOP

S(km/h)	A(m)	L(m)	B(m)	D(m)
50	50	60	35	15
60	50	90	45	15
70	75	120	50	15
80	100	175	55	15
90	100	200	65	20
100	150	250	70	20

WHERE:
S = SPEED LIMIT
A = SPACING BETWEEN SIGNS
L = LENGTH OF TAPER
B = LENGTH OF LONGITUDINAL BUFFER SPACE
D = SPACING BETWEEN DELINEATION DEVICES

DATE OF ISSUE: 2007-09 REVISED: 2012-01
 PATH: TESIGNS/Te-020.dgn

APPROVED: Original Signed By
Glenn Cuthbertson P. Eng.
 DIRECTOR: TRAFFIC ENGINEERING BRANCH

TMP-36

AREAS IN THE WORK ZONE

SHORT DURATION WORK

TRAFFIC CONTROL USING A PILOT VEHICLE FOR A BLIND CURVE

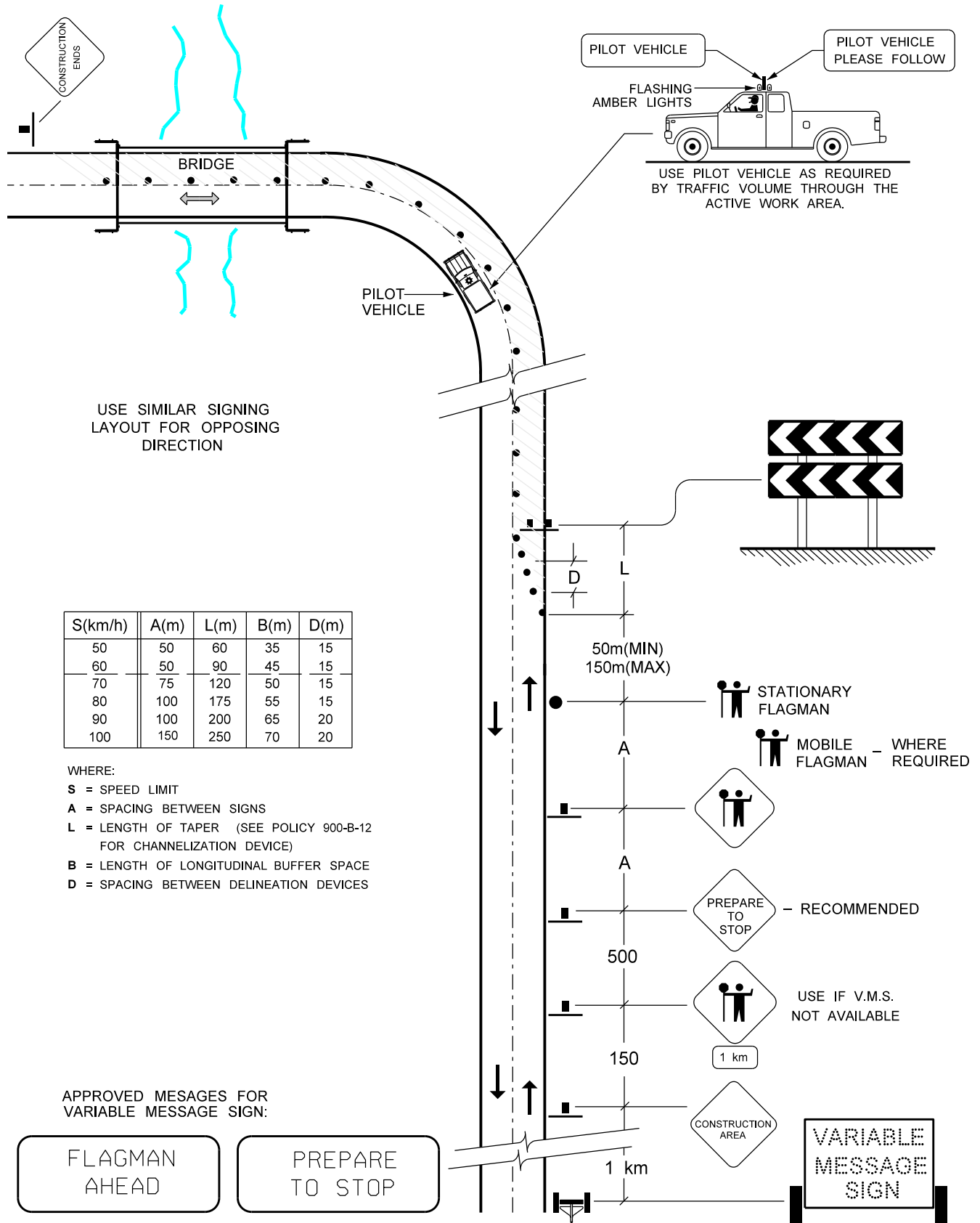

AREAS IN THE WORK ZONE

PAVEMENT STRUCTURAL TESTING ON TWO-LANE ROAD

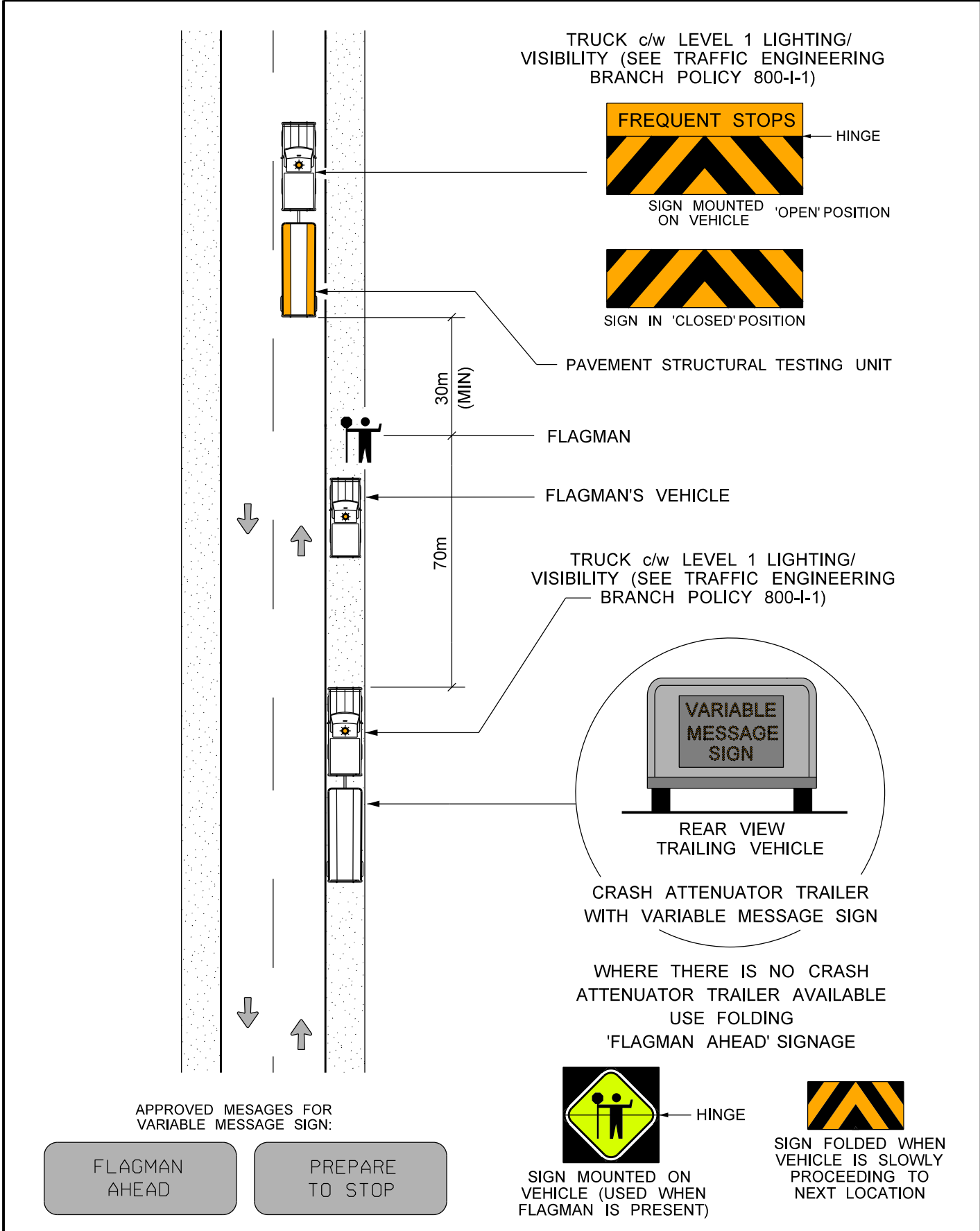

AREAS IN THE WORK ZONE

PAVEMENT STRUCTURAL TESTING ON MULTI-LANE DIVIDED ROAD

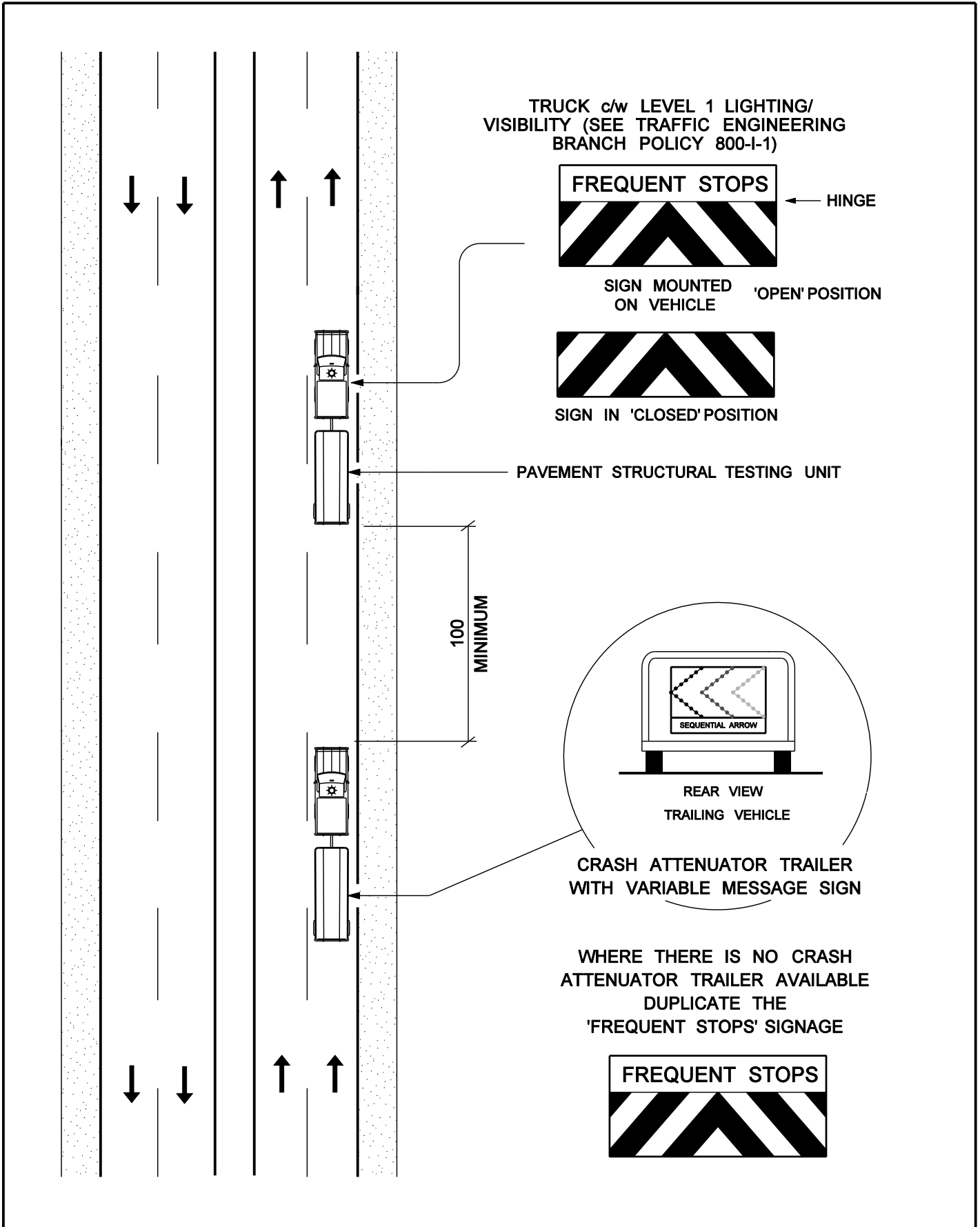

AREAS IN THE WORK ZONE

REFER TO POLICY
 900-F-3

FAST MOVING OPERATIONS - SOIL DRILL TRUCK/CORING VEHICLE

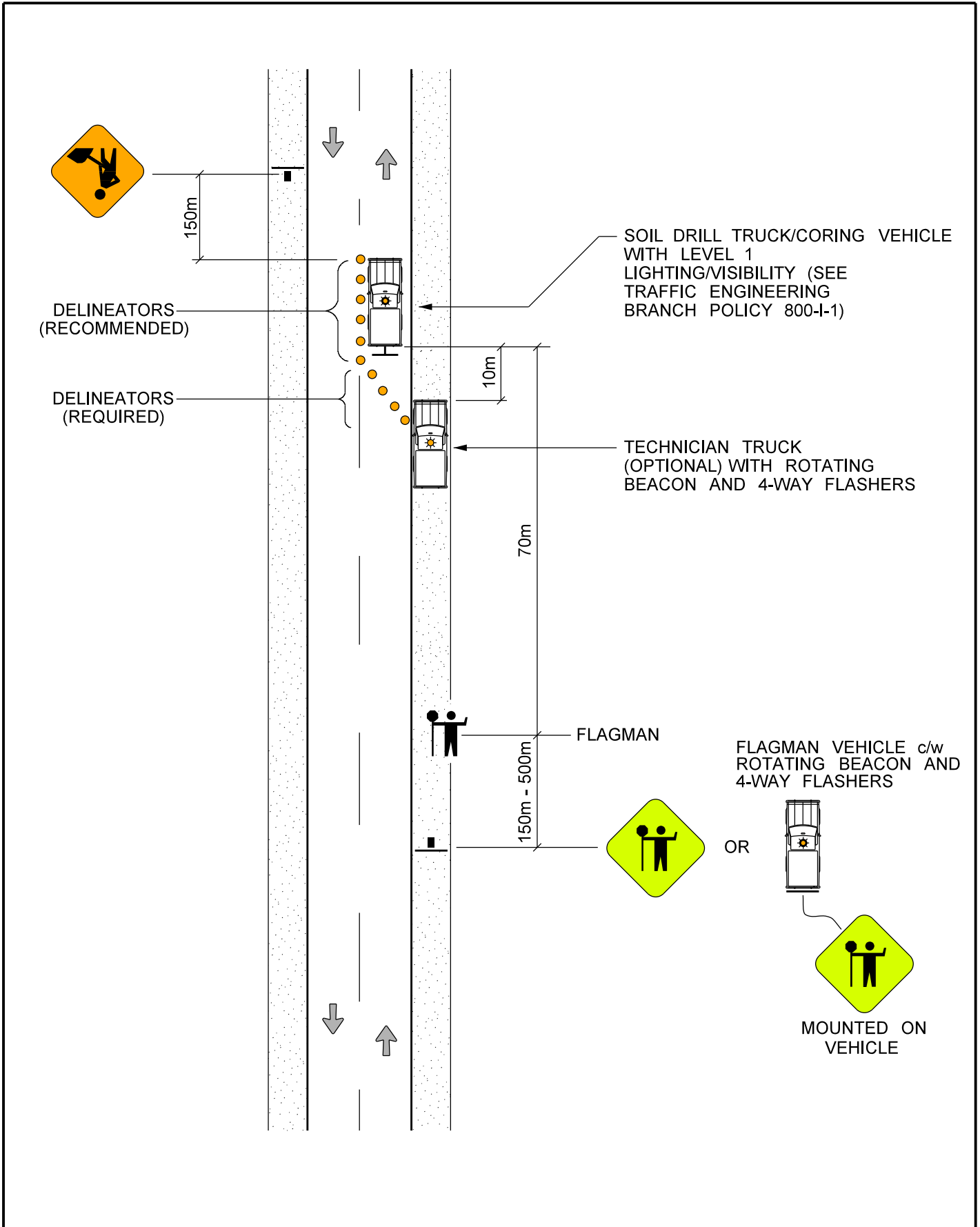

AREAS IN THE WORK ZONE

FAST MOVING OPERATIONS - PROFILOGRAPH UNIT

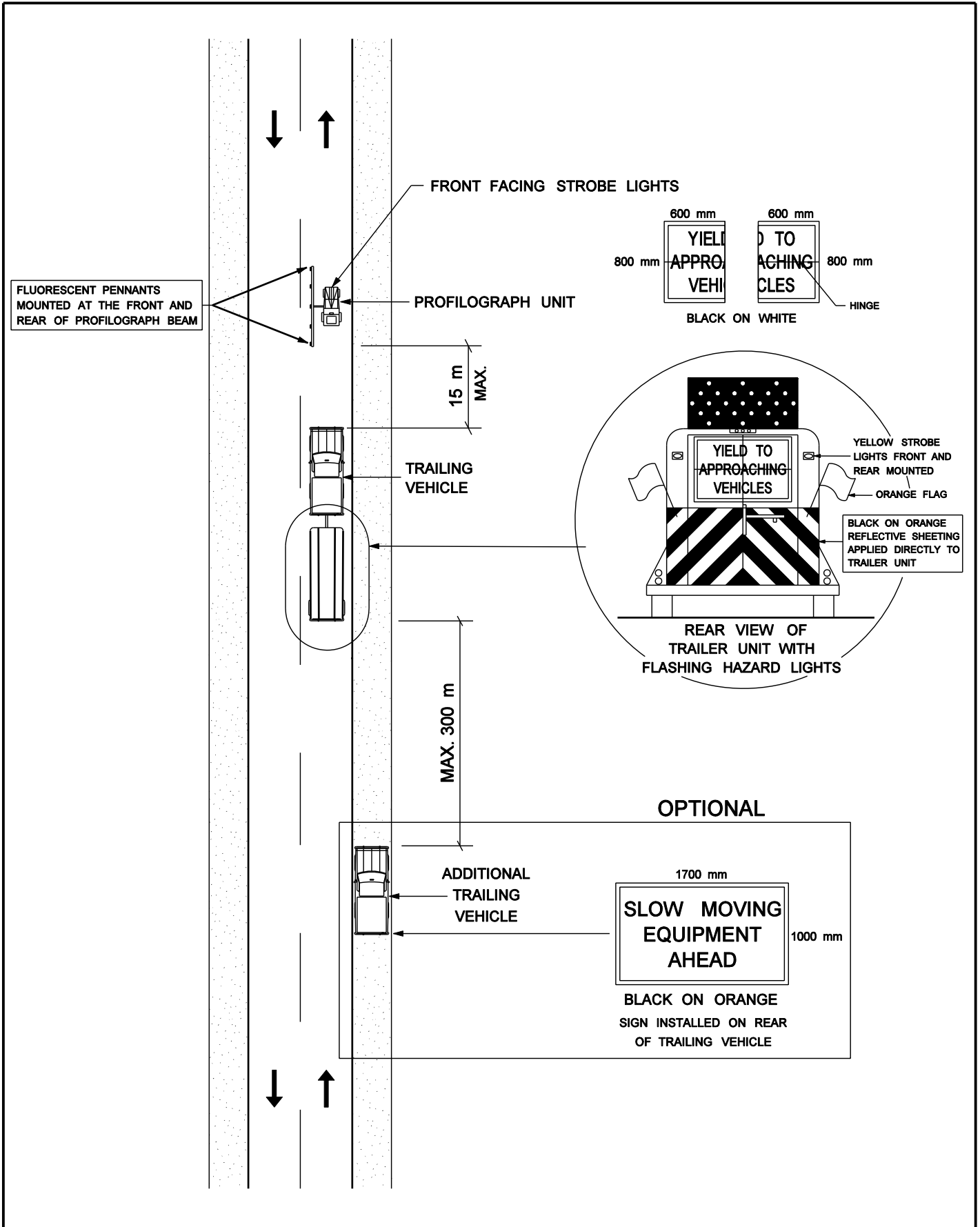

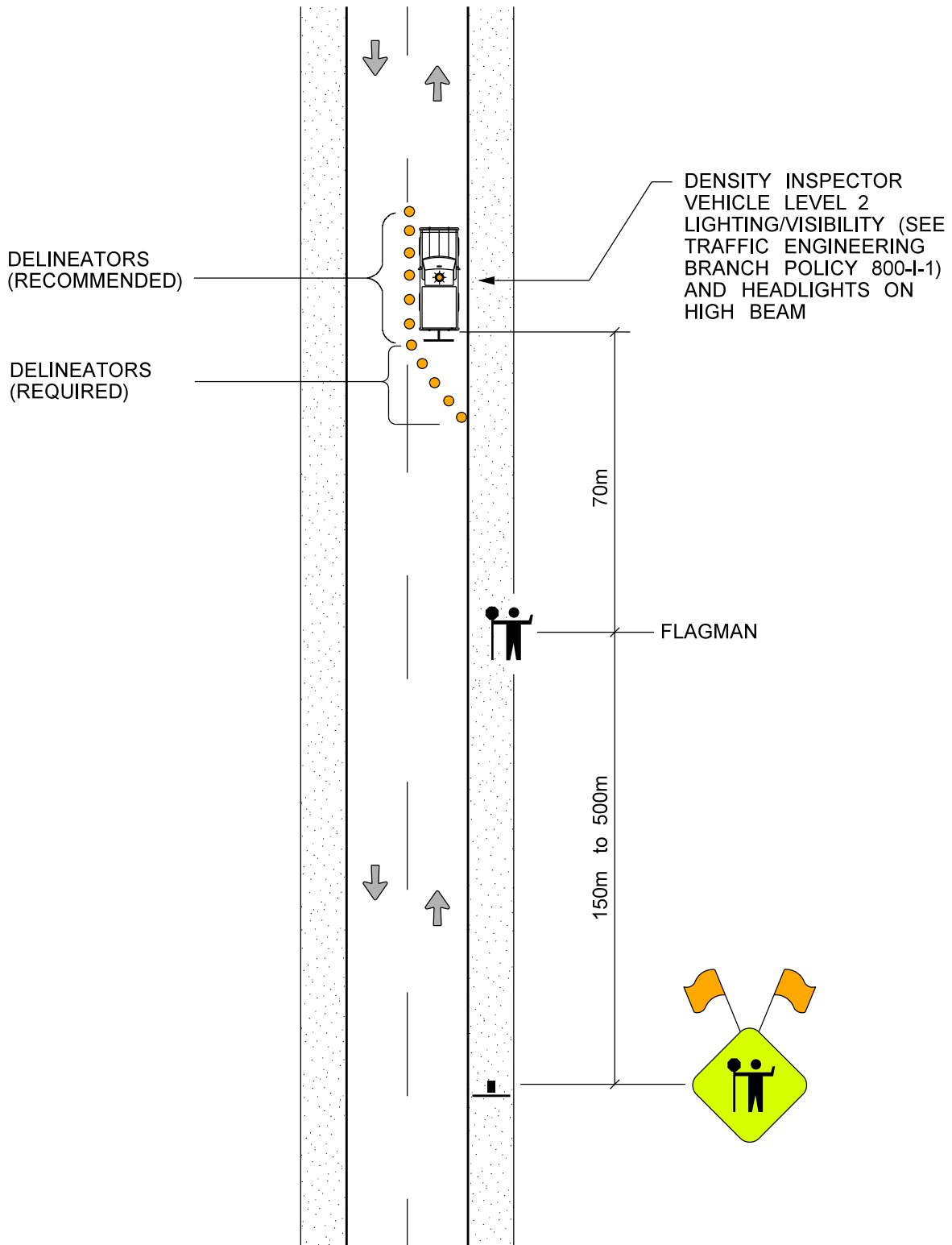

AREAS IN THE WORK ZONE

FAST MOVING OPERATIONS - HI - LOW TESTING

FLUORESCENT
 ORANGE PENNANTS

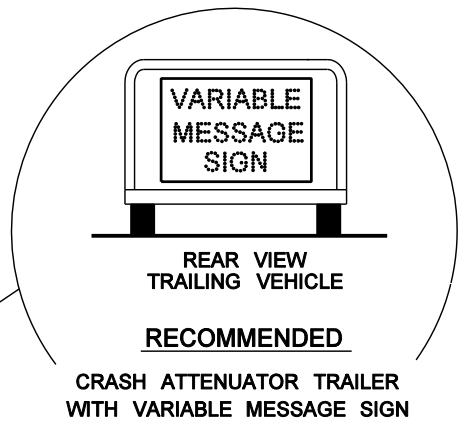
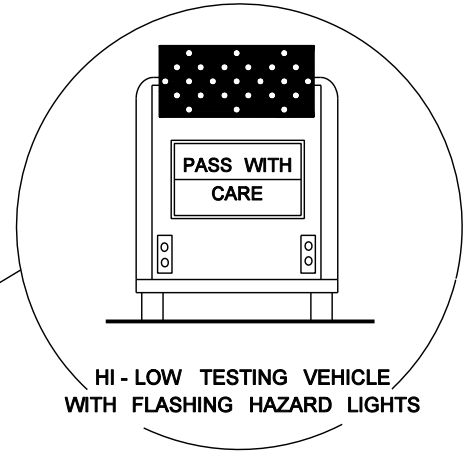
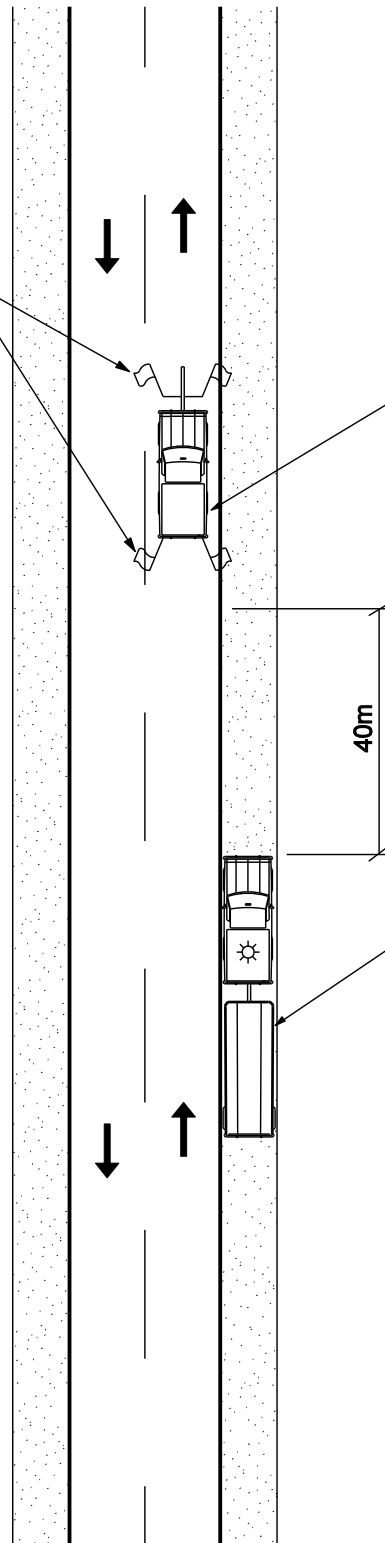

OR

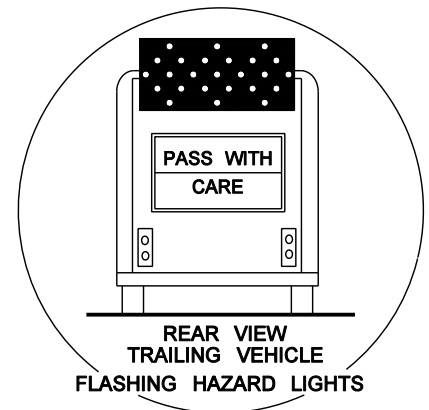

APPROVED MESSAGES FOR
 VARIABLE MESSAGE SIGN:

ROAD REPAIR
 AHEAD

PASS WITH
 CARE

TRAFFIC CONTROL FOR TRUCKS HAULING EXTRA-LONG BRIDGE GIRDERS

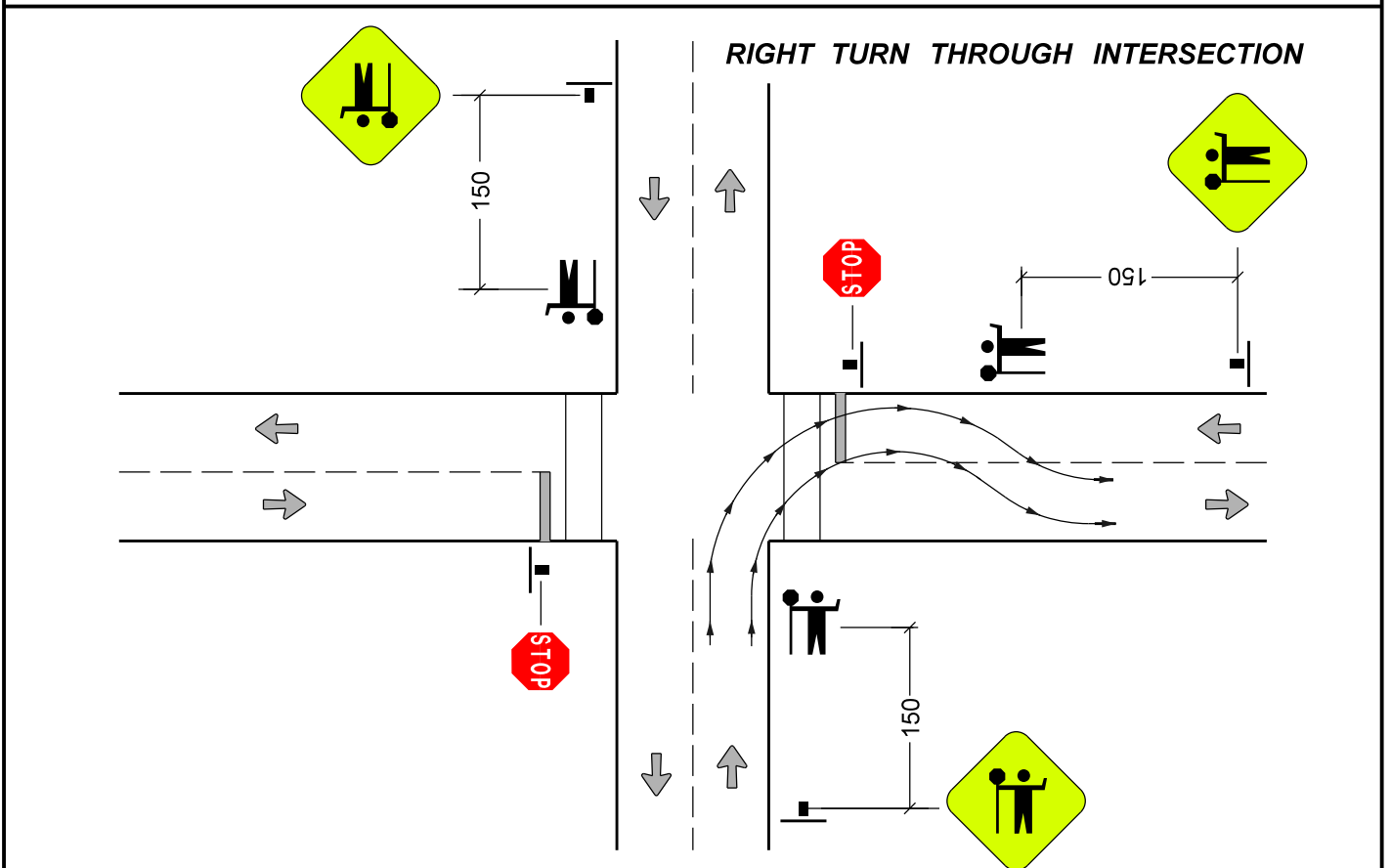
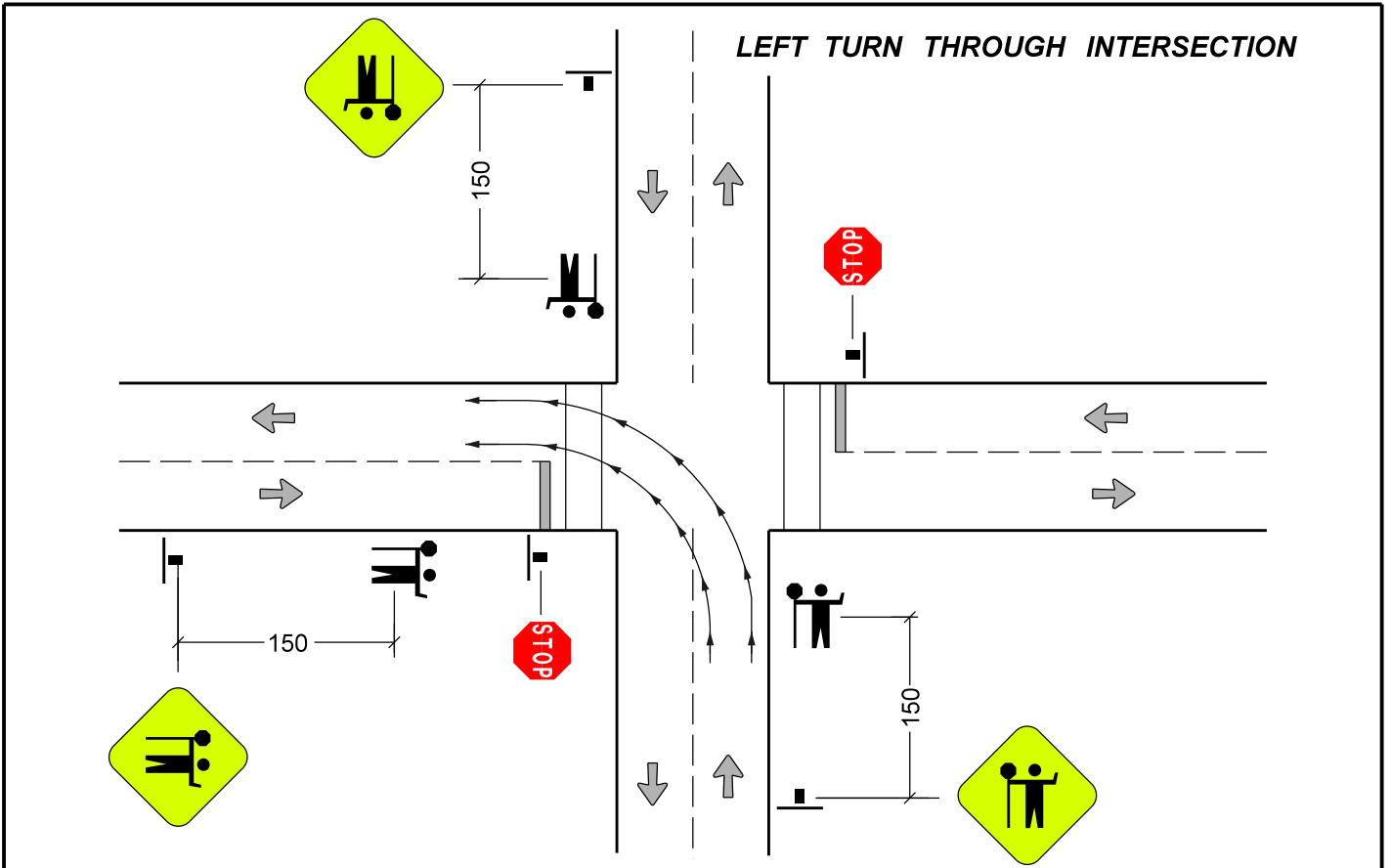

ASPHALITE OPERATION

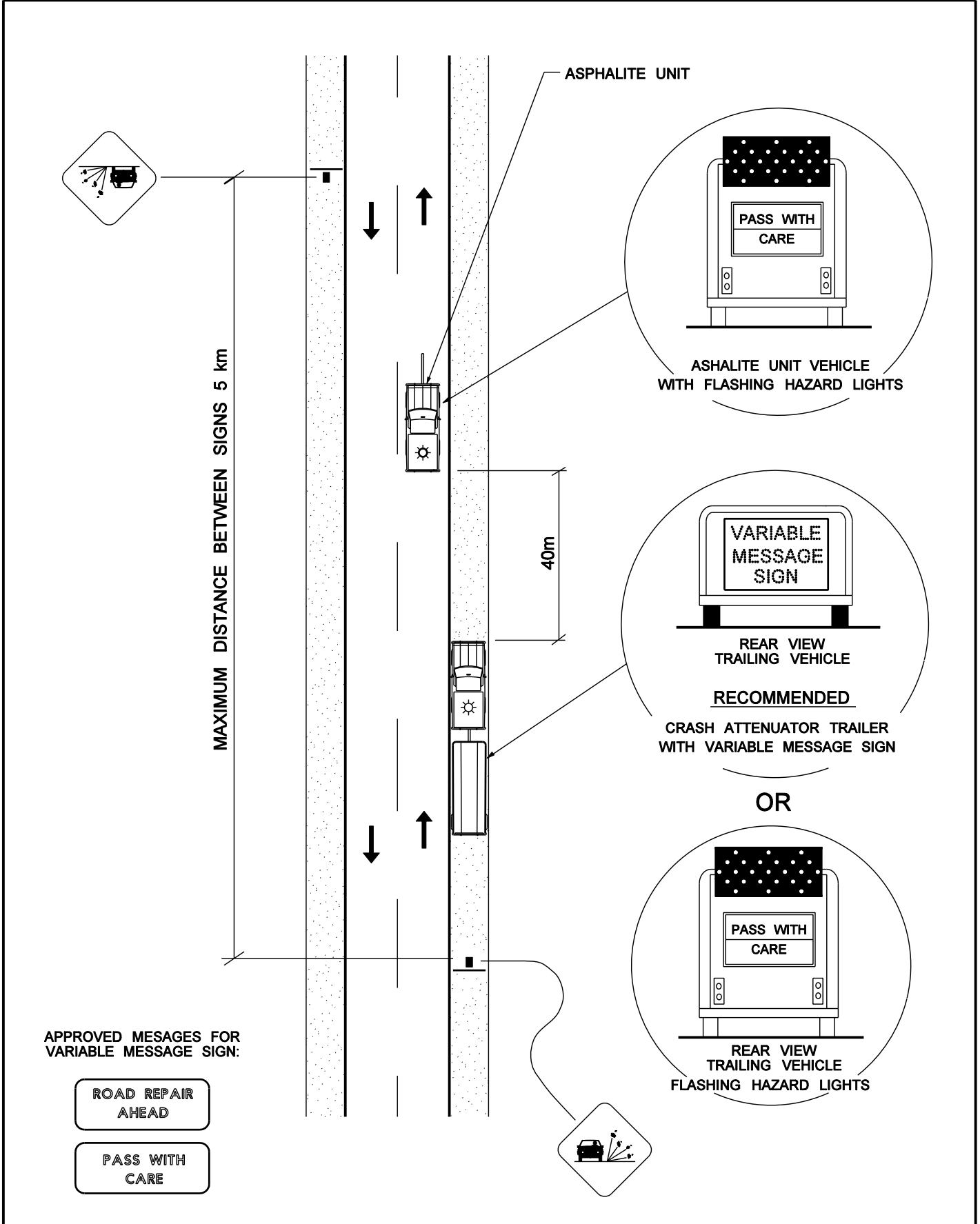

APPROVED MESSAGES FOR
VARIABLE MESSAGE SIGN:

- ROAD REPAIR
AHEAD
- PASS WITH
CARE

MAINTENANCE GRAVELLING OPERATION

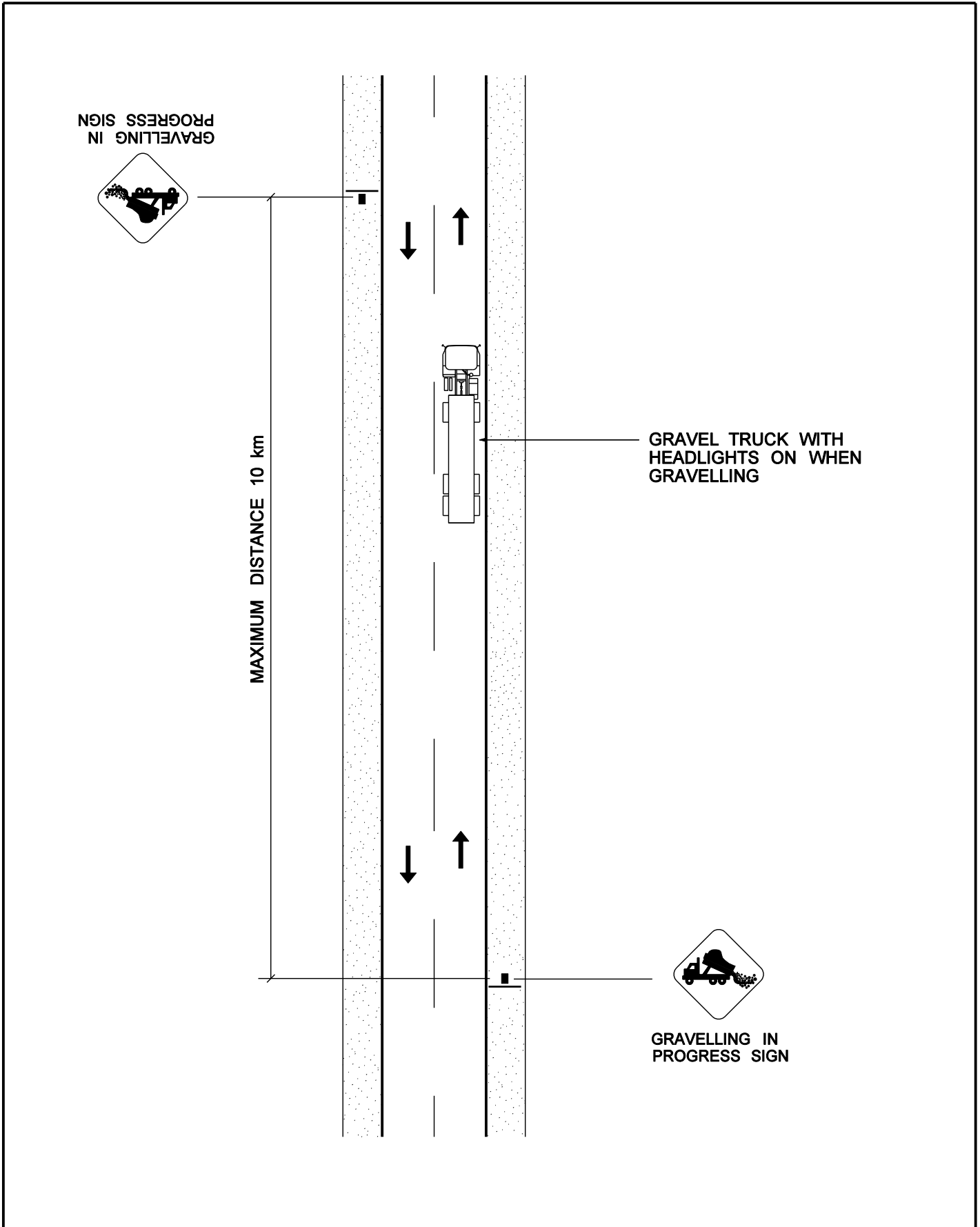

**LOWER SPEED (≤ 70 km/h)
 LOWER VOLUME INTERSECTIONS**

POSTED SPEED	A
50	50
60	50
70	75
80	100
90	100
100	150

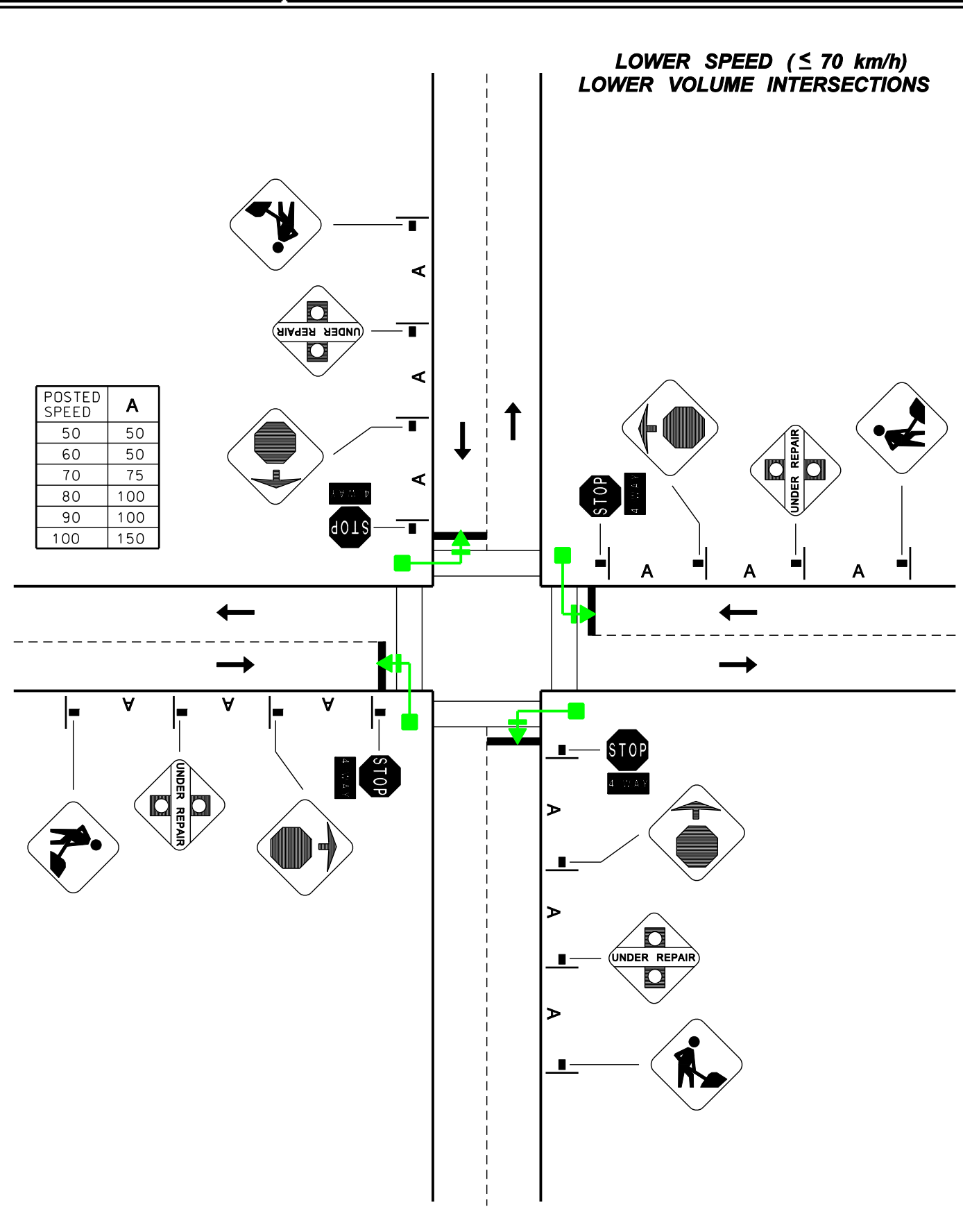

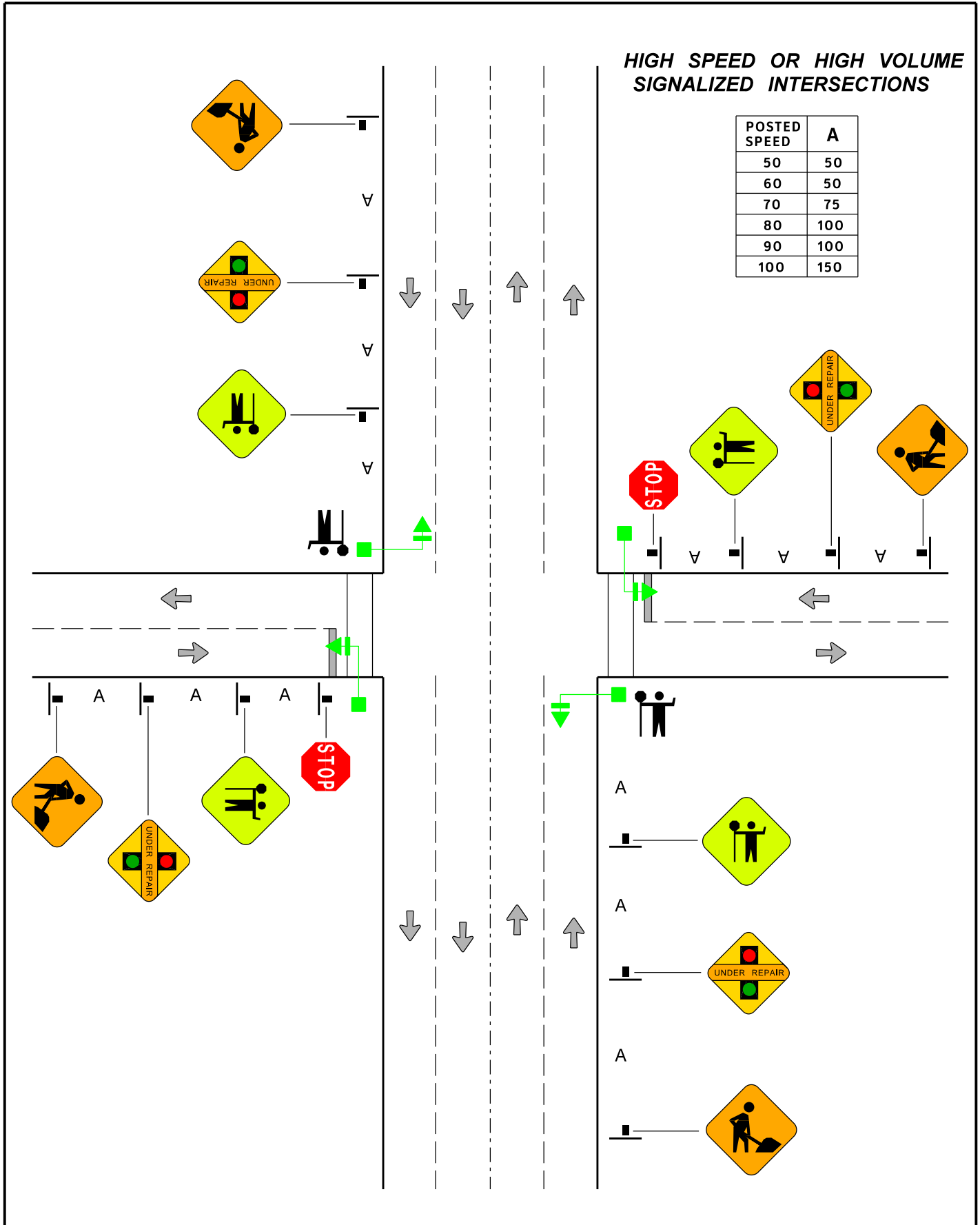

PAVEMENT MARKING OPERATION

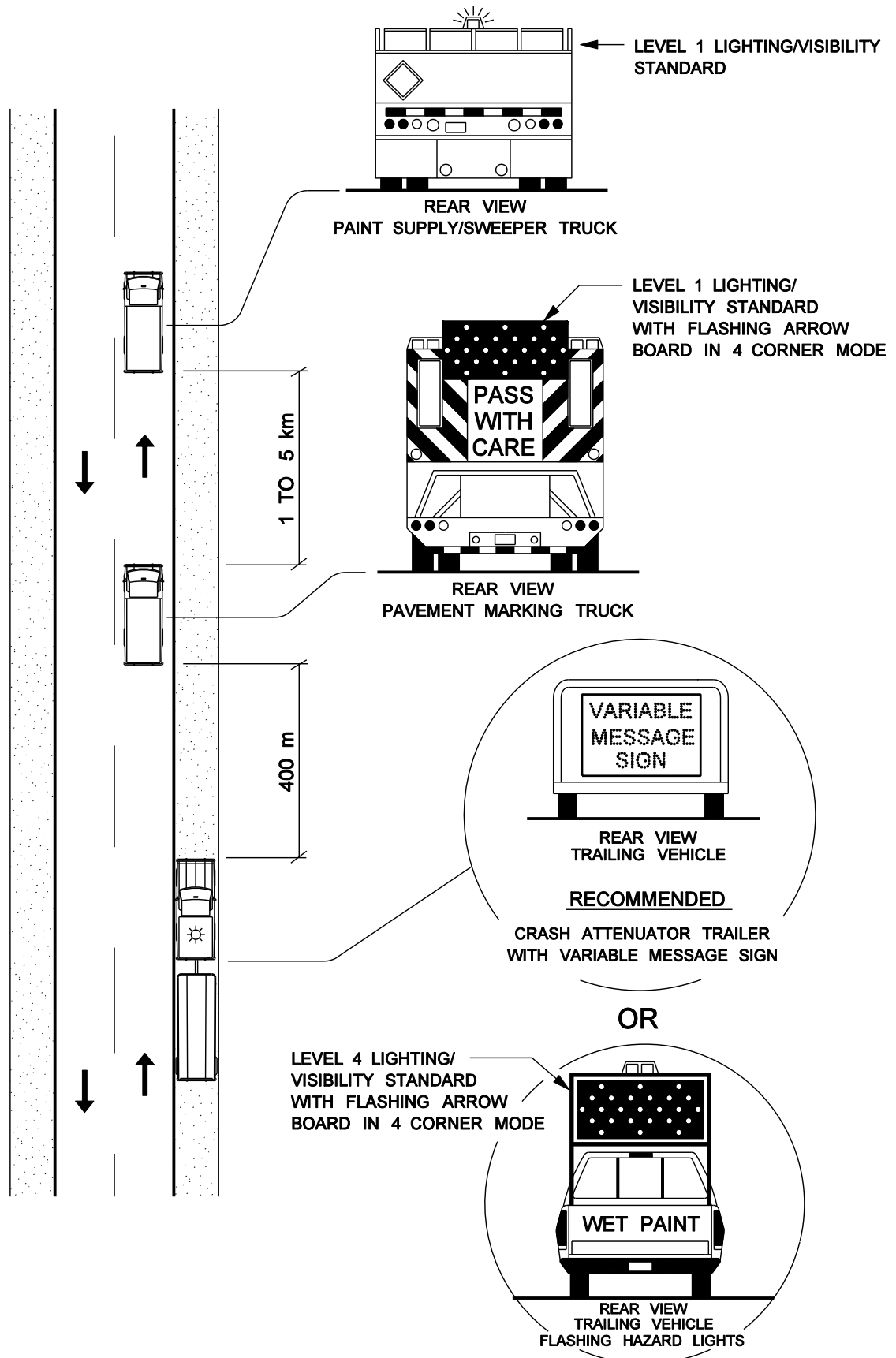

PAVEMENT MARKING OPERATION - MULTI-LANE ROAD

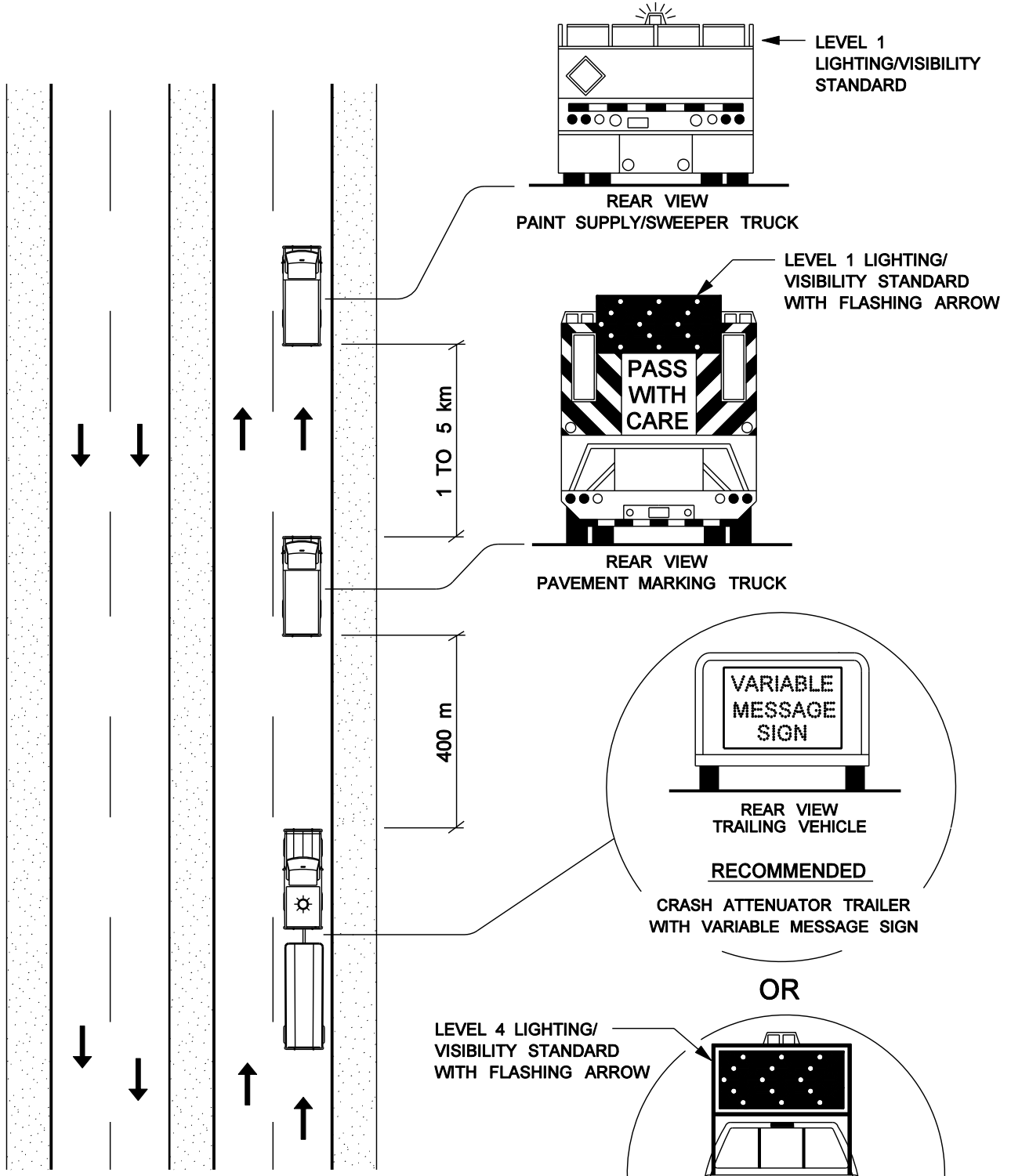

APPROVED MESSAGES FOR VARIABLE MESSAGE SIGN:

WET PAINT

PASS WITH CARE

**RURAL PAVEMENT MARKING OPERATION
 STOP CONTROL**

**2 LANE - MINIMUM TRAFFIC CONTROL FOR SMALL PAVEMENT MARKING
 MACHINE OPERATION (MARKING CROSSWALKS, STOPLINES, ETC.)**

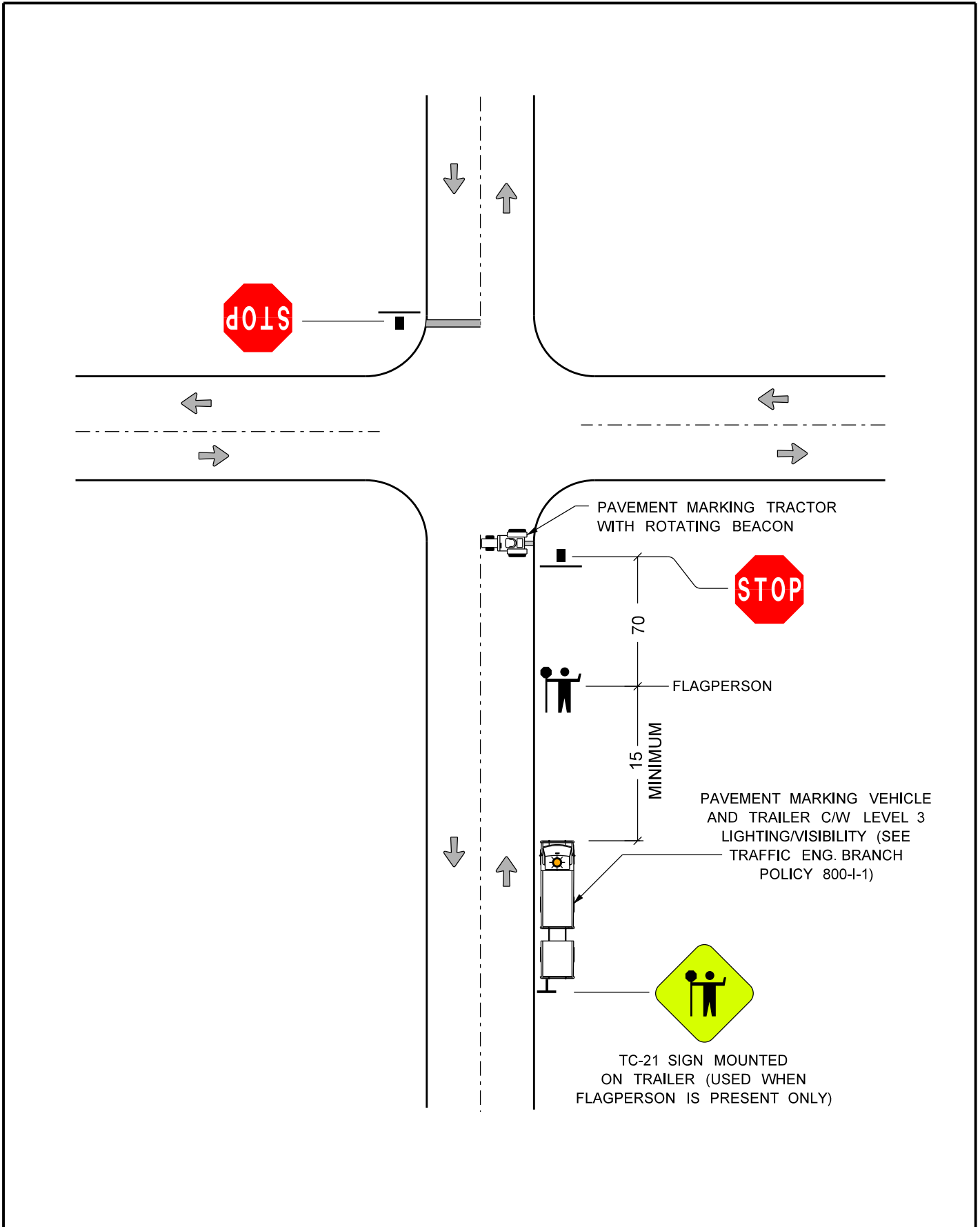

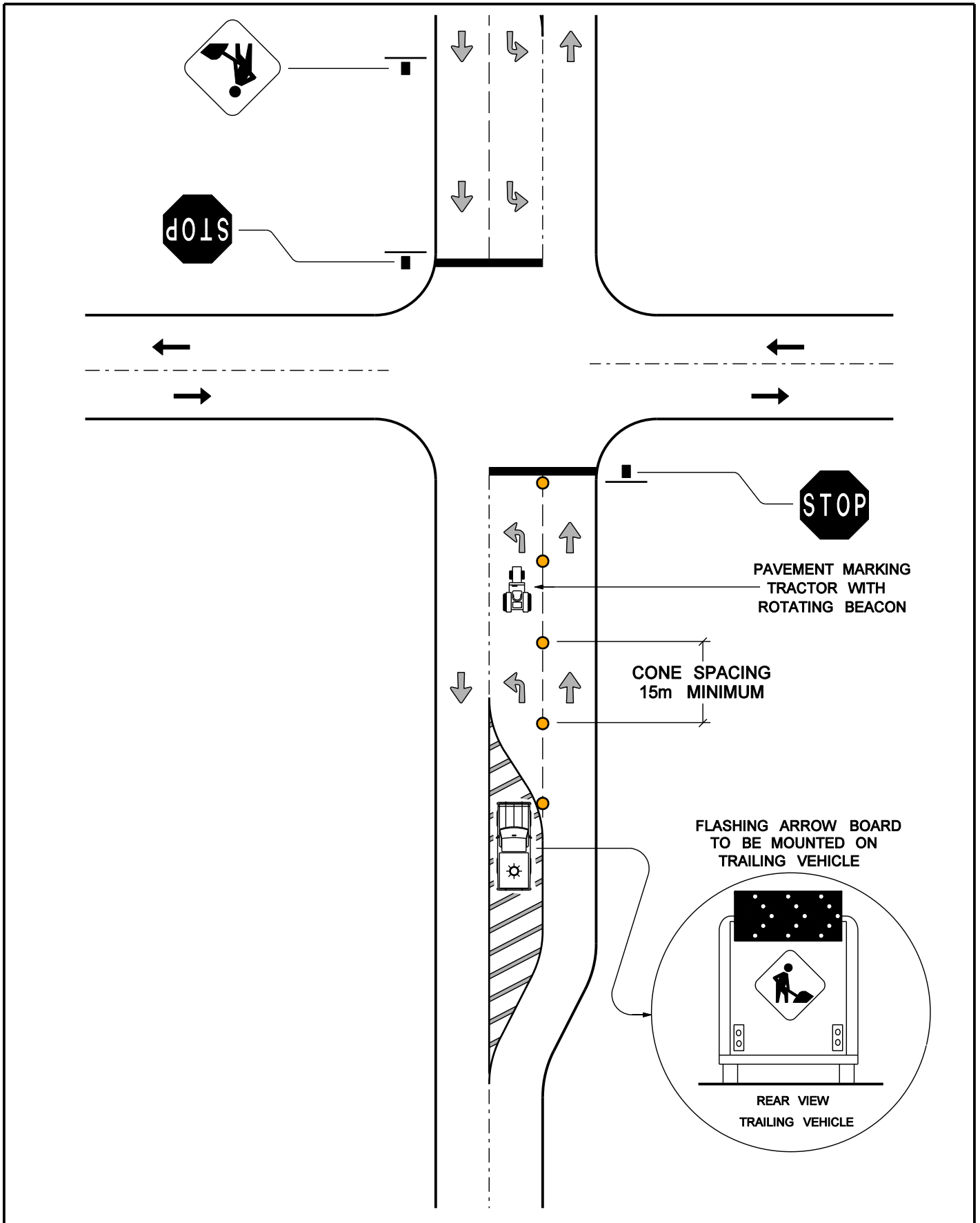

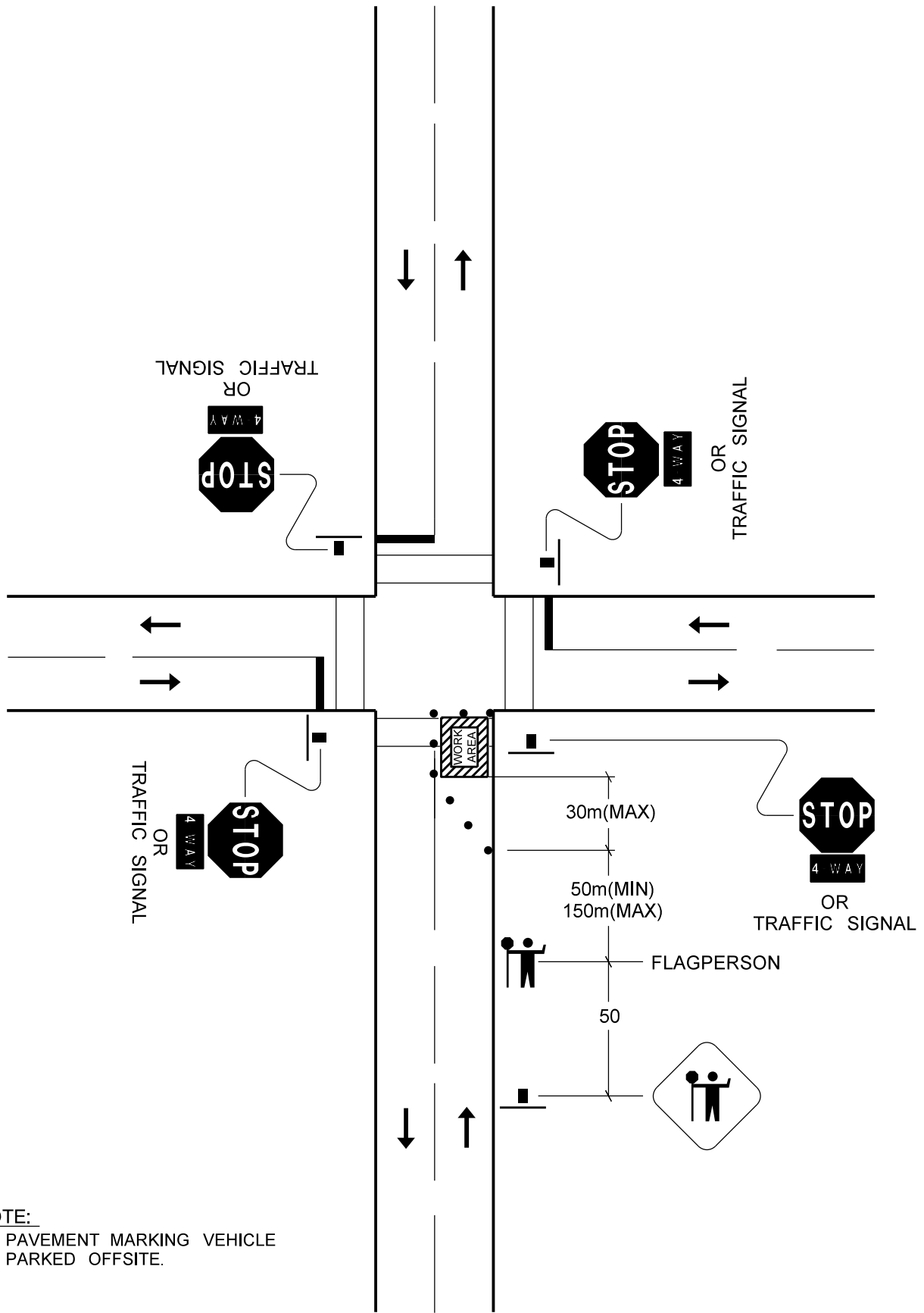

NOTE:
 PAVEMENT MARKING VEHICLE
 PARKED OFFSITE.

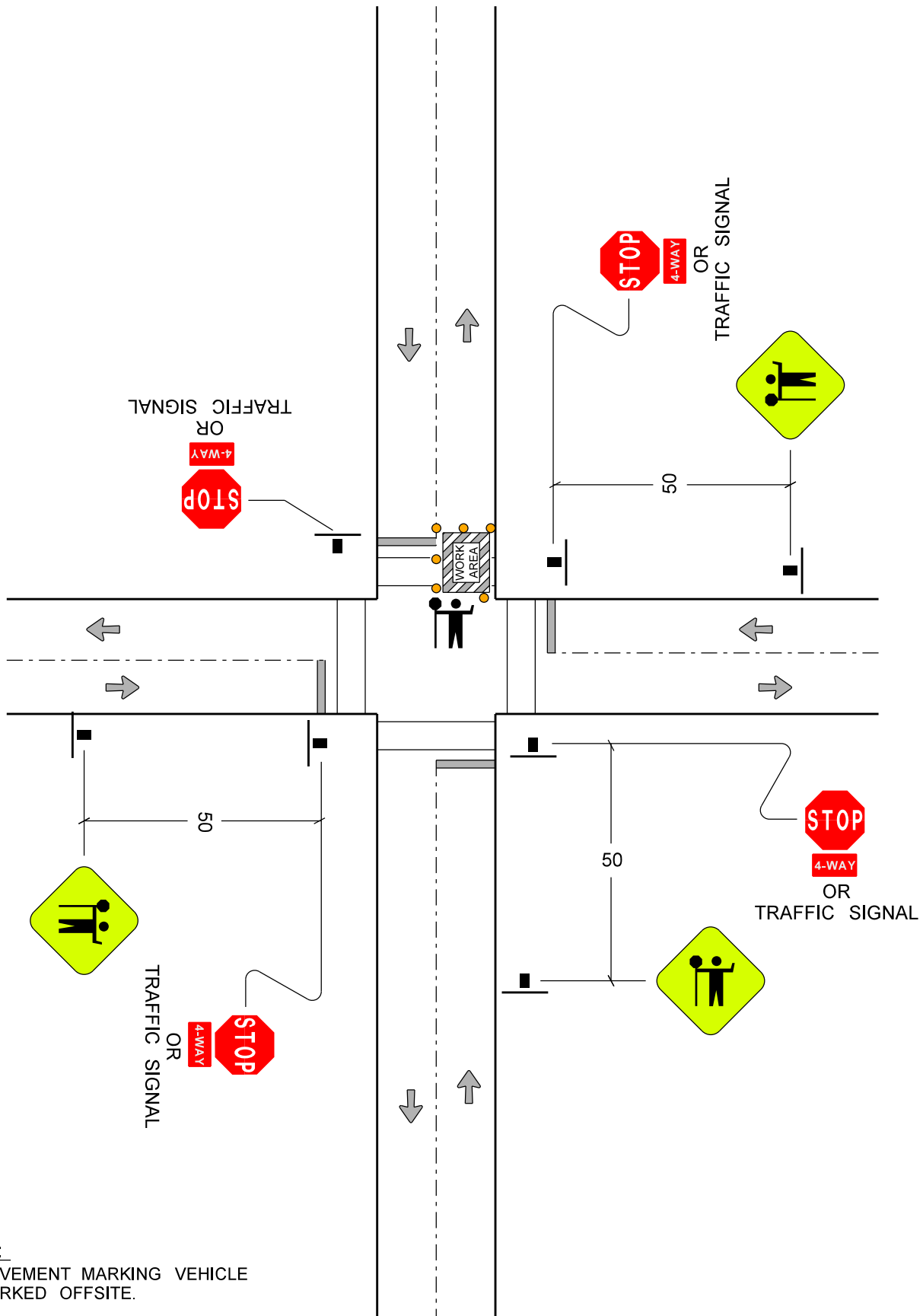

NOTE:
 PAVEMENT MARKING VEHICLE
 PARKED OFFSITE.

**NEAR SIDE OF INTERSECTION
PAINTING STOP LINES OR PEDESTRIAN CORRIDORS - SIGNALIZED**

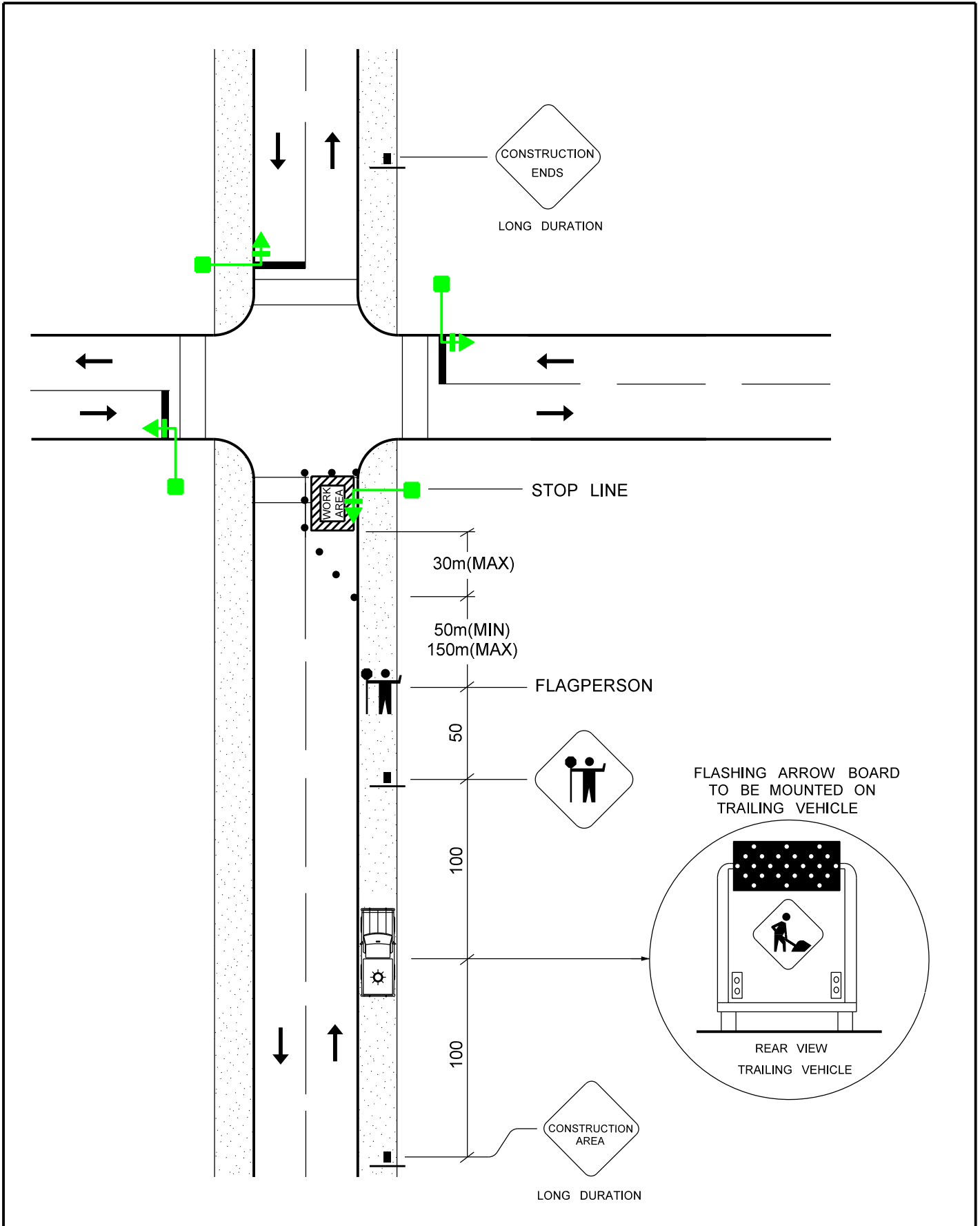

**FAR SIDE OF INTERSECTION
PAINTING PEDESTRIAN CORRIDORS - SIGNALIZED**

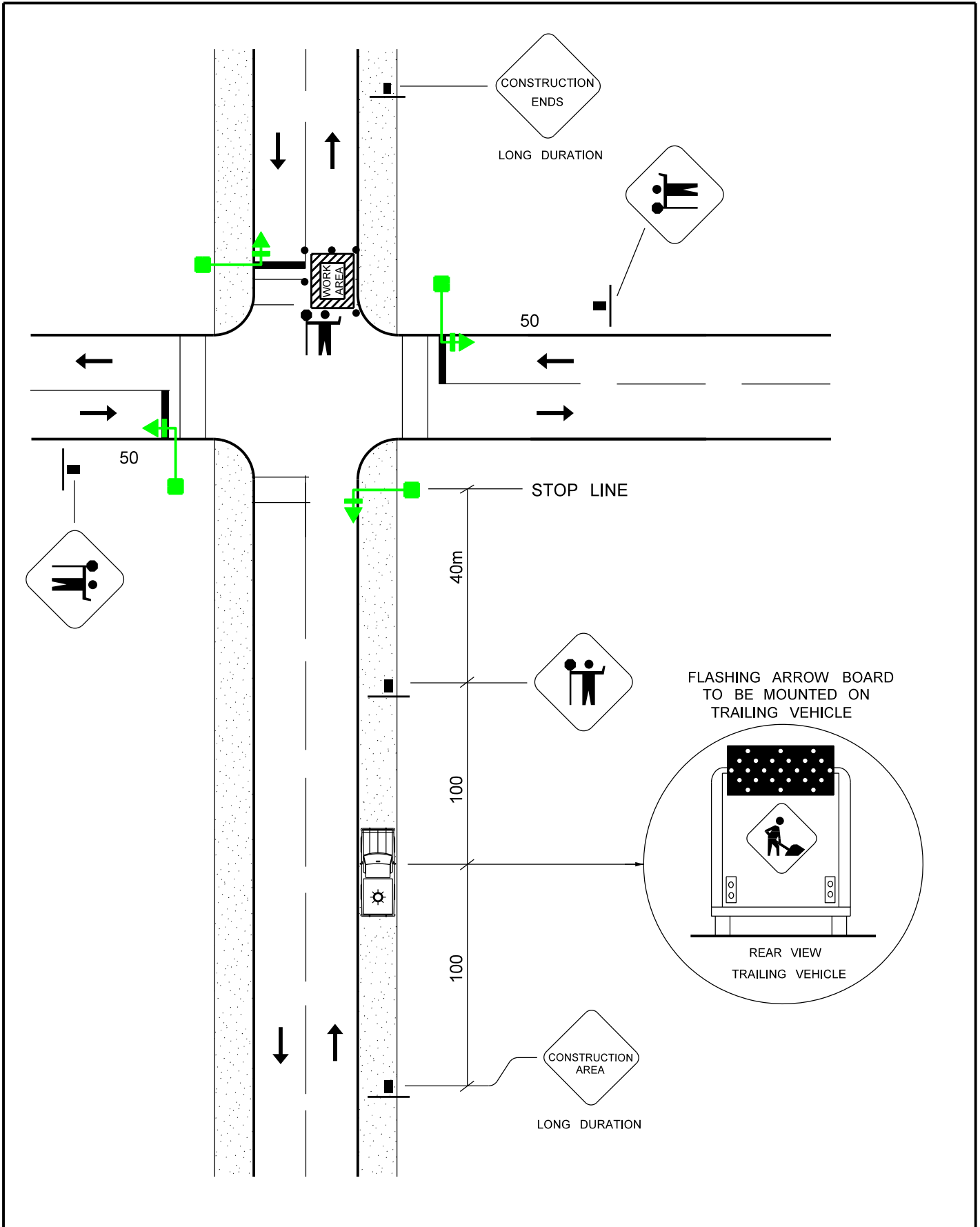

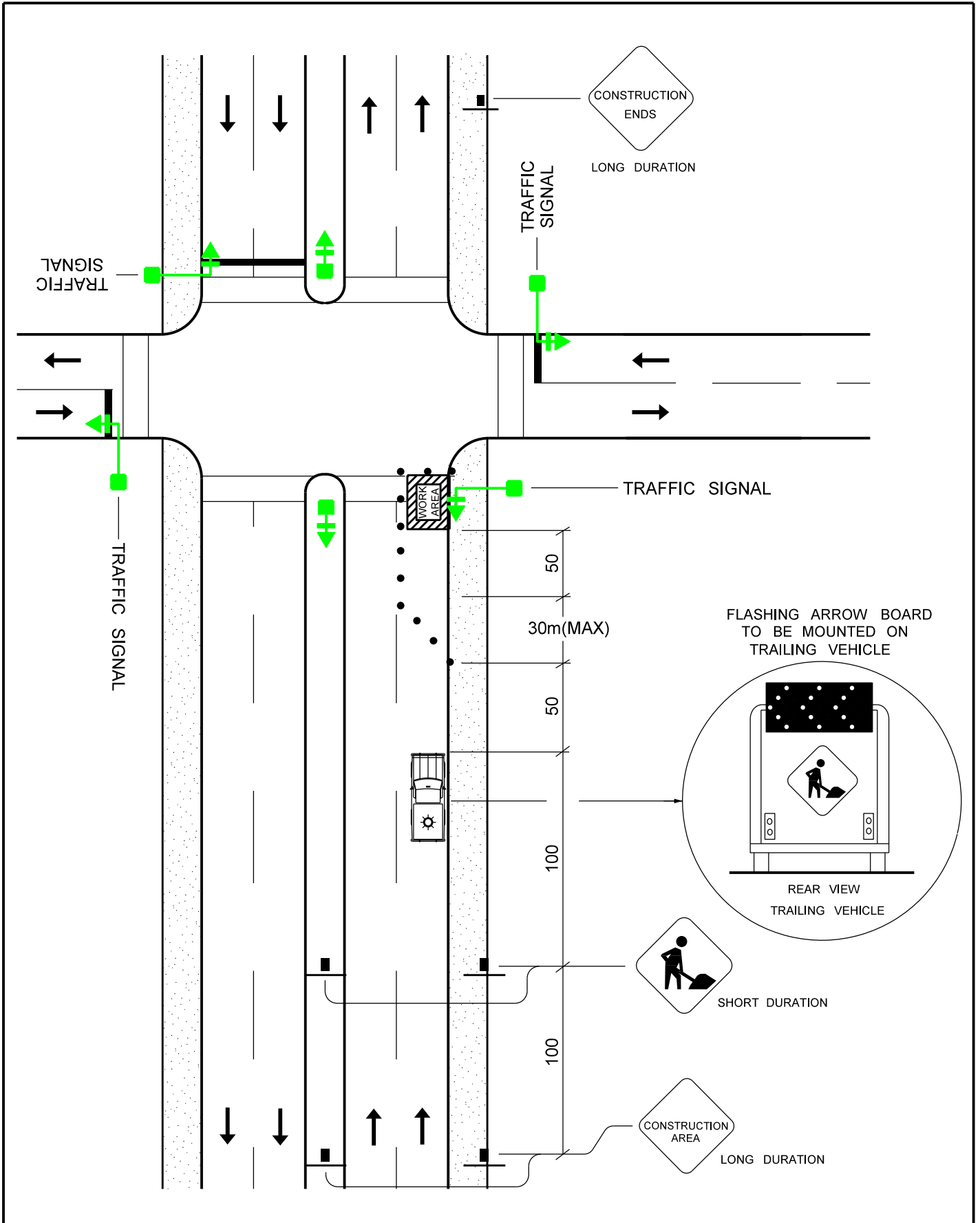

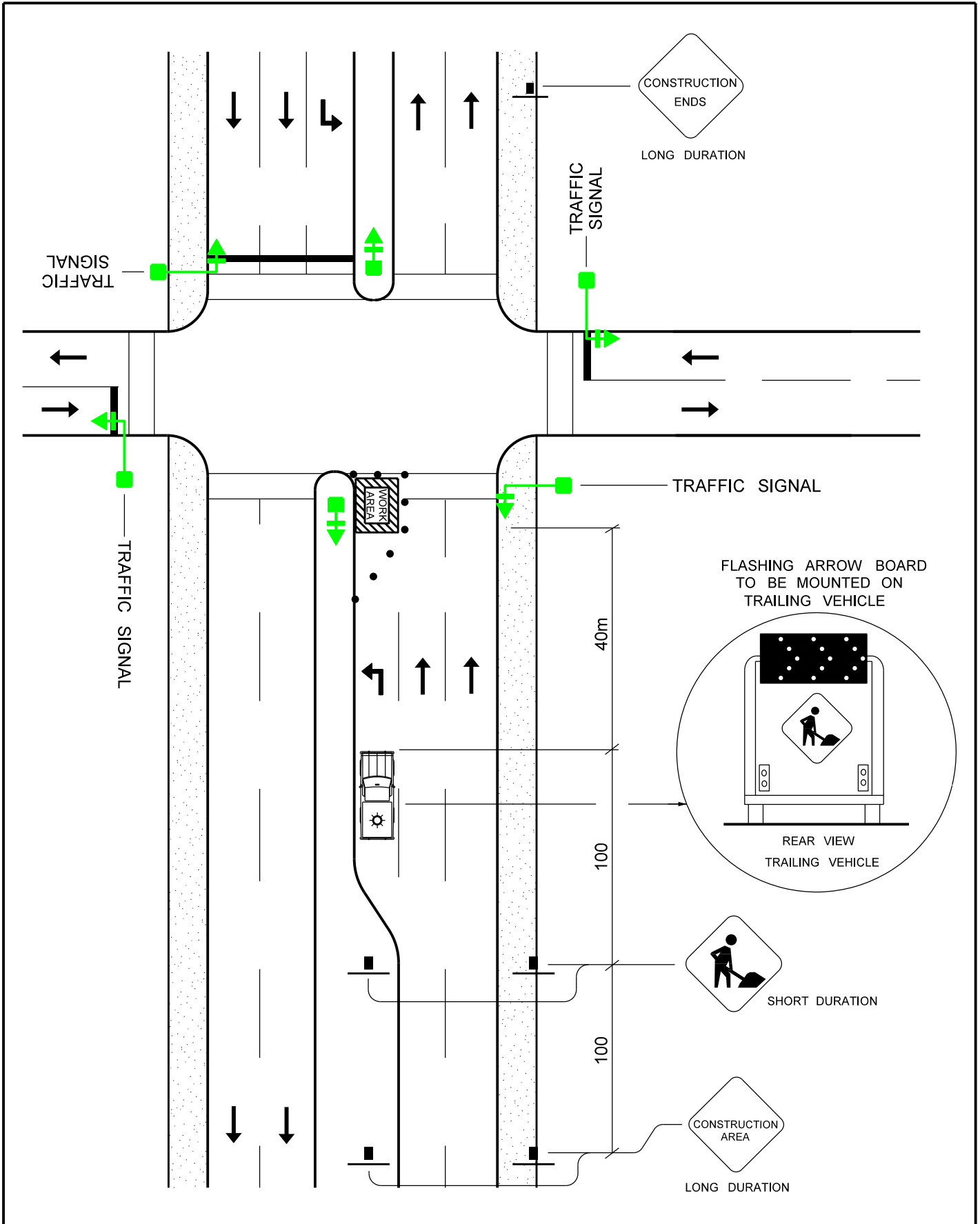

PAVEMENT MARKING GORE AREA AND BY-PASS LANE

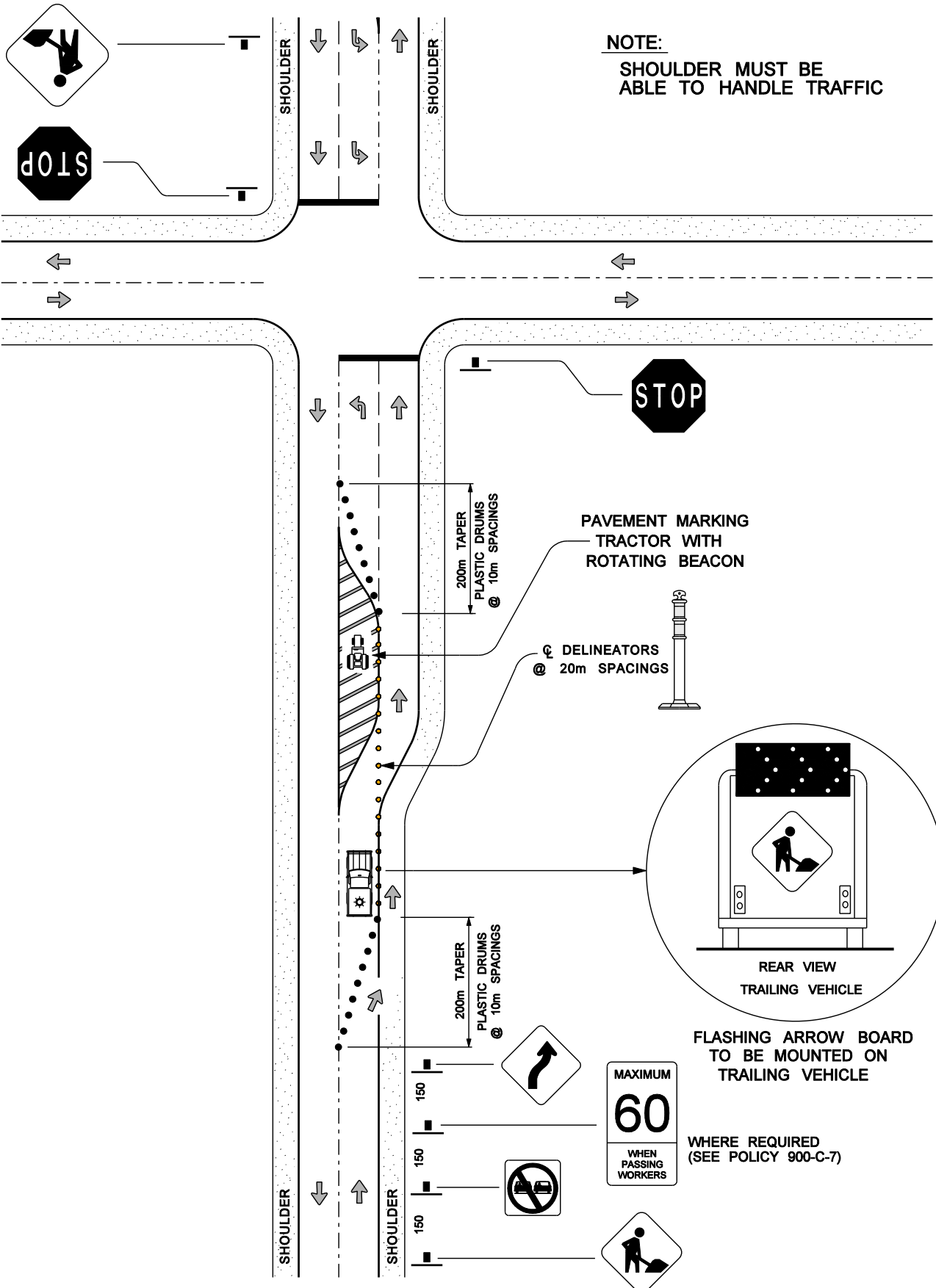

MICRO-SURFACING

FLAGGER CONTROLLED VOLUME > 60 VEHICLES/HOUR

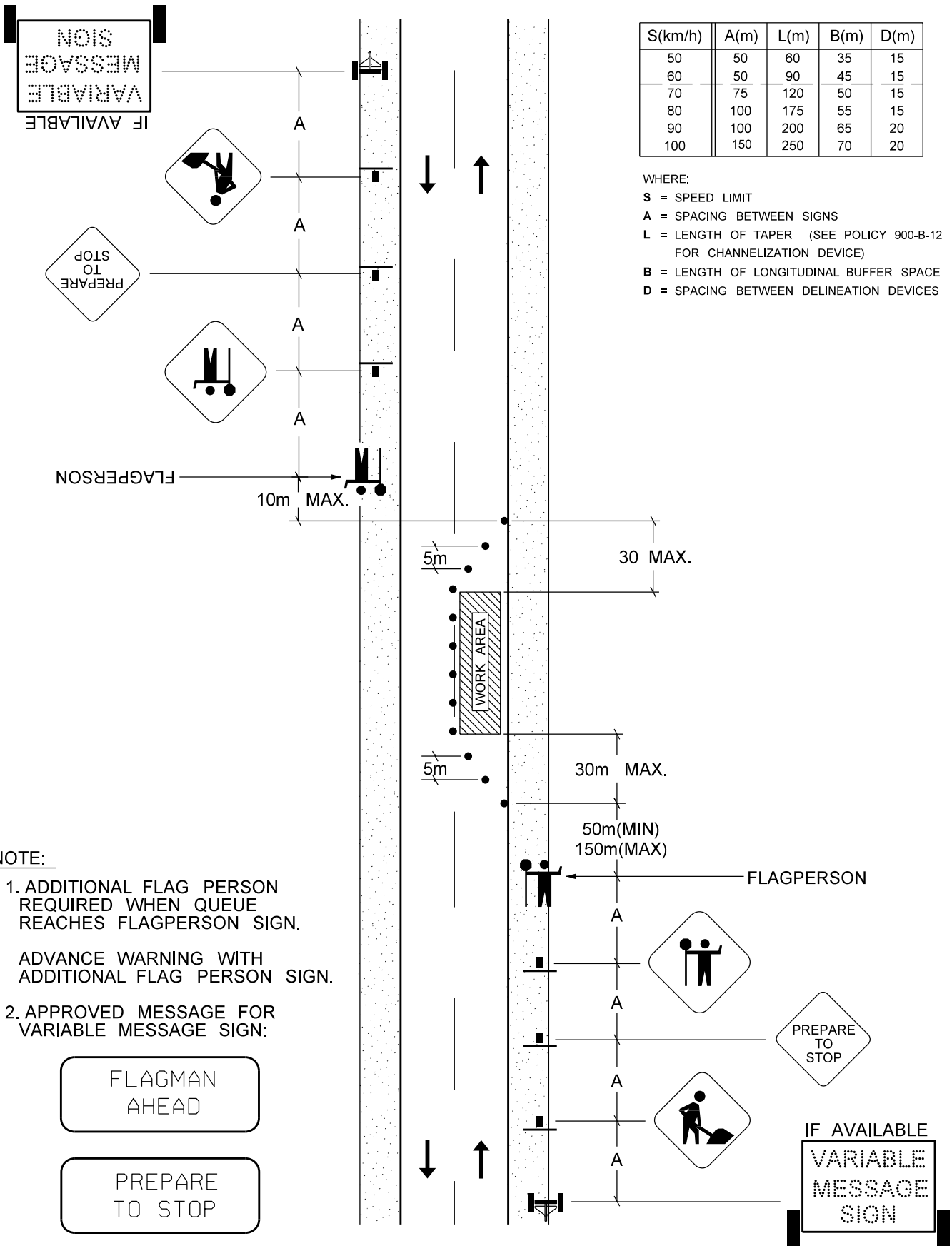

S(km/h)	A(m)	L(m)	B(m)	D(m)
50	50	60	35	15
60	50	90	45	15
70	75	120	50	15
80	100	175	55	15
90	100	200	65	20
100	150	250	70	20

WHERE:
S = SPEED LIMIT
A = SPACING BETWEEN SIGNS
L = LENGTH OF TAPER (SEE POLICY 900-B-12 FOR CHANNELIZATION DEVICE)
B = LENGTH OF LONGITUDINAL BUFFER SPACE
D = SPACING BETWEEN DELINEATION DEVICES

NOTE:
 1. ADDITIONAL FLAG PERSON REQUIRED WHEN QUEUE REACHES FLAGPERSON SIGN.
 ADVANCE WARNING WITH ADDITIONAL FLAG PERSON SIGN.
 2. APPROVED MESSAGE FOR VARIABLE MESSAGE SIGN:

FLAGMAN AHEAD

PREPARE TO STOP

CONVENTIONAL SURVEY

CENTERLINE SURVEY WORK MULTI-LANE ROAD

S(km/h)	A(m)	L(m)	B(m)	D(m)
50	50	60	35	15
60	50	90	45	15
70	75	120	50	15
80	100	175	55	15
90	100	200	65	20
100	150	250	70	20

WHERE:

S = SPEED LIMIT

A = SPACING BETWEEN SIGNS

L = LENGTH OF TAPER (SEE POLICY 900-B-12 FOR CHANNELIZATION DEVICE)

B = LENGTH OF LONGITUDINAL BUFFER SPACE

D = SPACING BETWEEN DELINEATION DEVICES

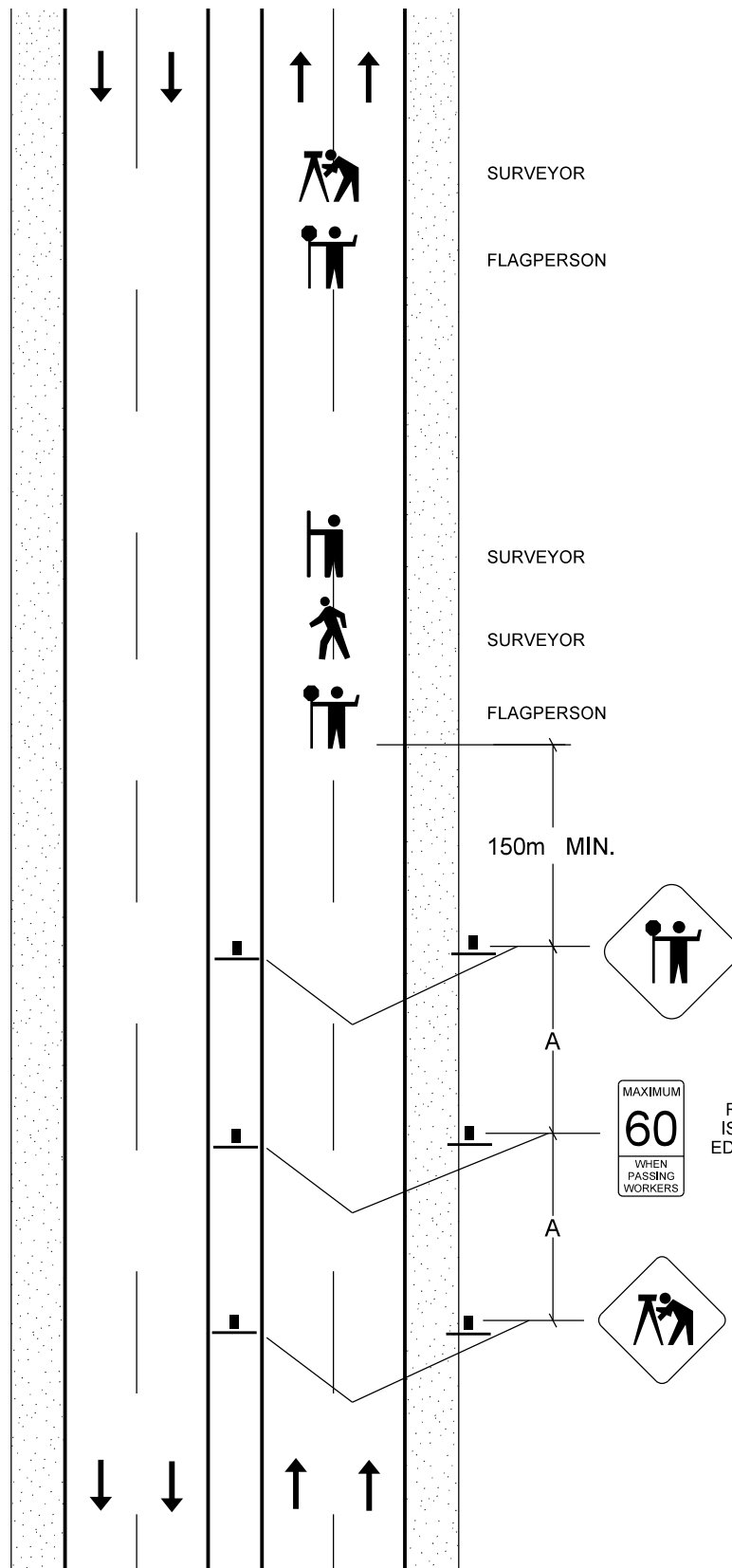

DRAFT

CONVENTIONAL SURVEY

CENTERLINE SURVEY WORK - TWO-LANE ROAD

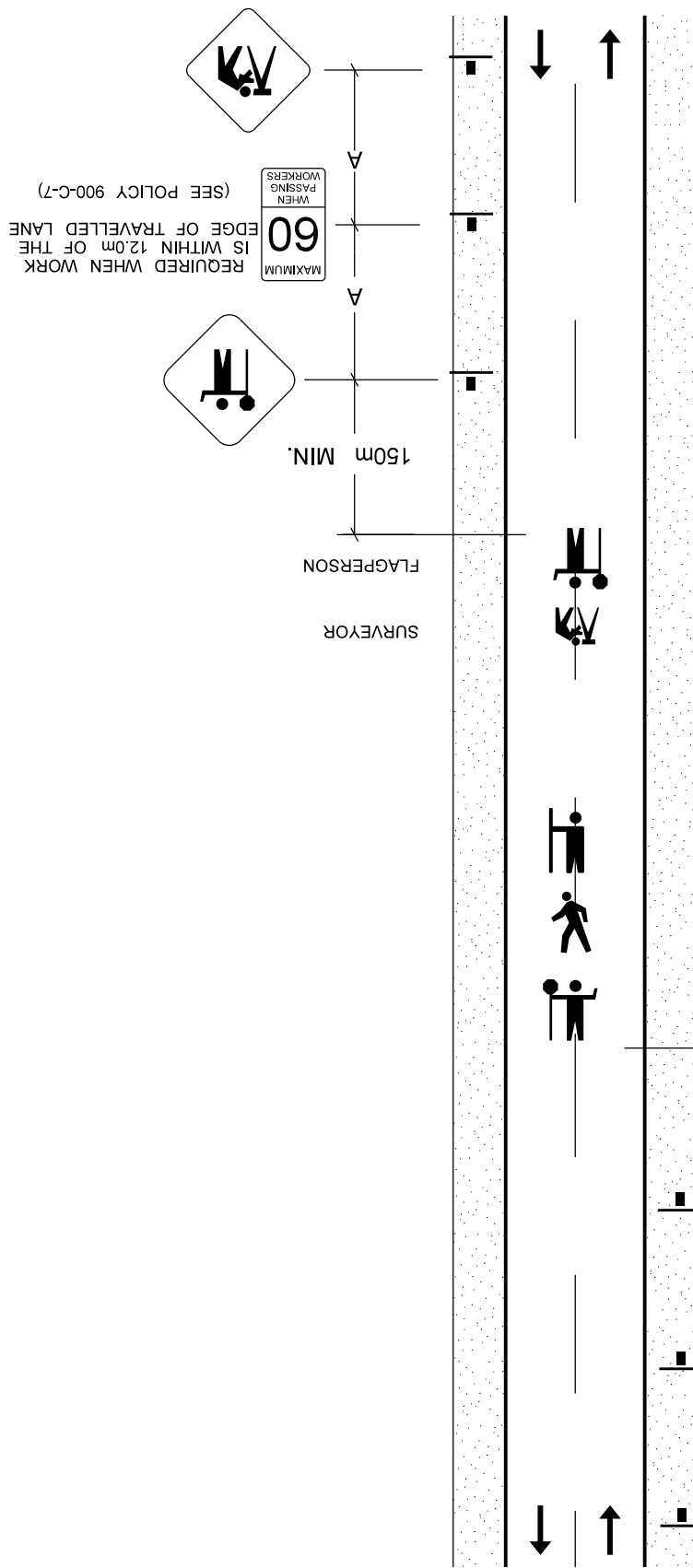

S(km/h)	A(m)	L(m)	B(m)	D(m)
50	50	60	35	15
60	50	90	45	15
70	75	120	50	15
80	100	175	55	15
90	100	200	65	20
100	150	250	70	20

WHERE:
S = SPEED LIMIT
A = SPACING BETWEEN SIGNS
L = LENGTH OF TAPER (SEE POLICY 900-B-12 FOR CHANNELIZATION DEVICE)
B = LENGTH OF LONGITUDINAL BUFFER SPACE
D = SPACING BETWEEN DELINEATION DEVICES

SURVEYOR
 SURVEYOR
 FLAGPERSON

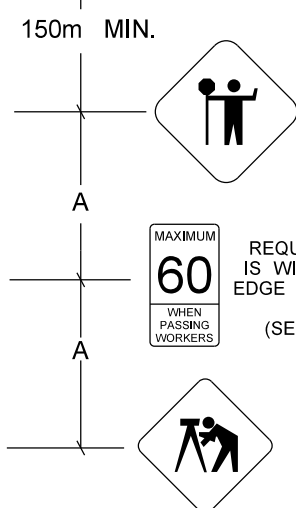

DRAFT

ELECTRONIC (ALLEGRO) SURVEY

CENTERLINE SURVEY WORK MULTI-LANE ROAD

S(km/h)	A(m)	L(m)	B(m)	D(m)
50	50	60	35	15
60	50	90	45	15
70	75	120	50	15
80	100	175	55	15
90	100	200	65	20
100	150	250	70	20

WHERE:

S = SPEED LIMIT

A = SPACING BETWEEN SIGNS

L = LENGTH OF TAPER (SEE POLICY 900-B-12 FOR CHANNELIZATION DEVICE)

B = LENGTH OF LONGITUDINAL BUFFER SPACE

D = SPACING BETWEEN DELINEATION DEVICES

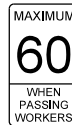
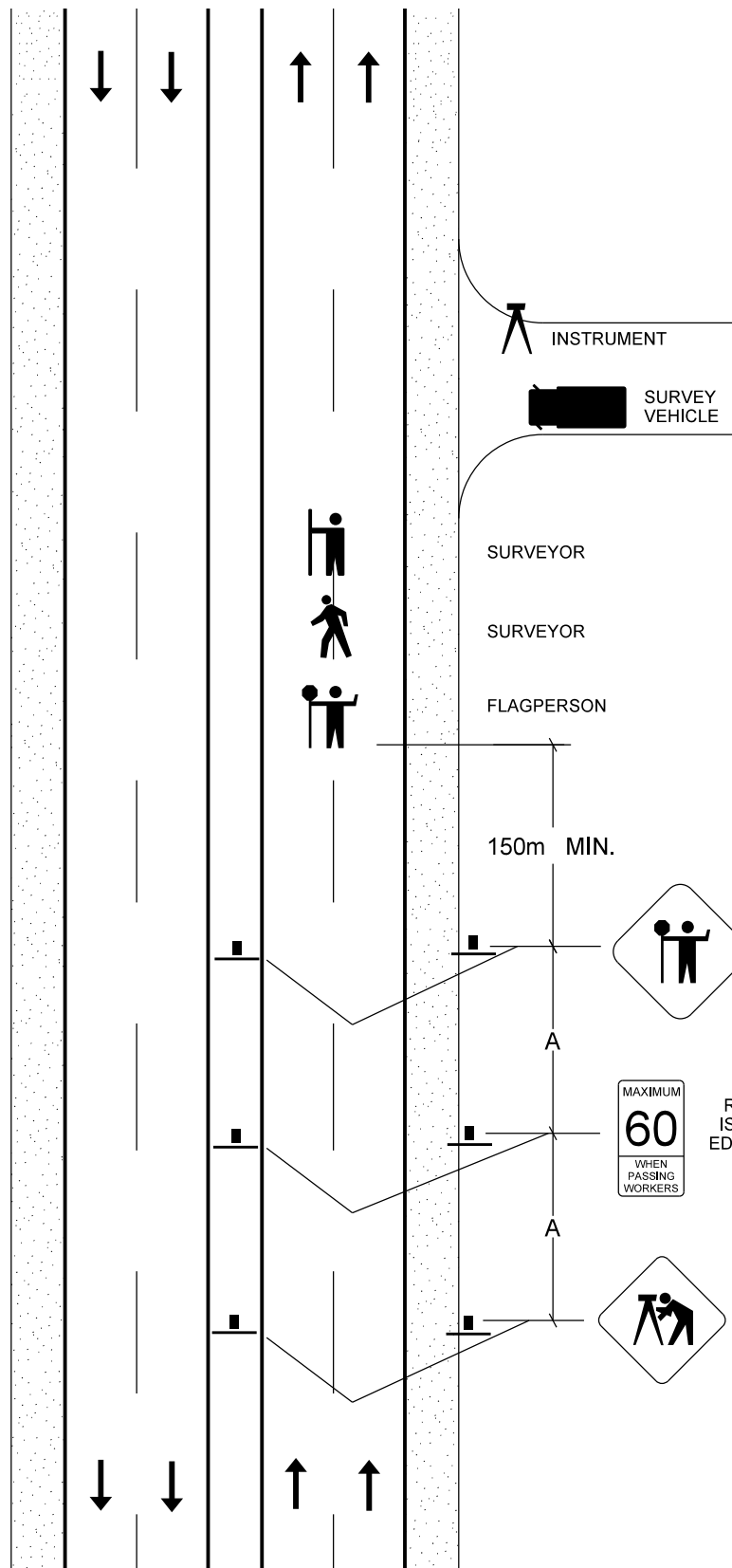

REQUIRED WHEN WORK IS WITHIN 12.0m OF THE EDGE OF TRAVELLED LANE

(SEE POLICY 900-C-7)



DRAFT

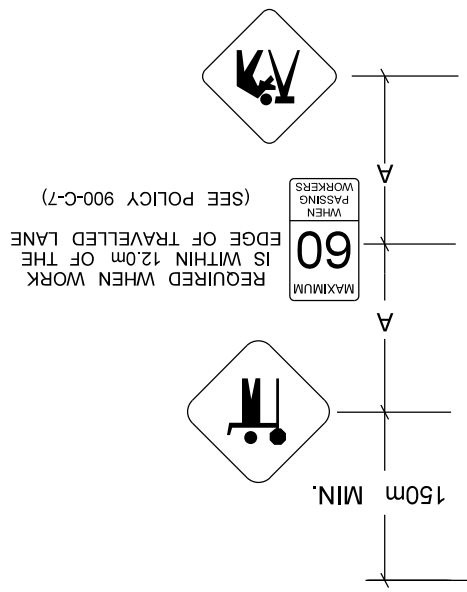

S(km/h)	A(m)	L(m)	B(m)	D(m)
50	50	60	35	15
60	50	90	45	15
70	75	120	50	15
80	100	175	55	15
90	100	200	65	20
100	150	250	70	20

WHERE:
S = SPEED LIMIT
A = SPACING BETWEEN SIGNS
L = LENGTH OF TAPER (SEE POLICY 900-B-12 FOR CHANNELIZATION DEVICE)
B = LENGTH OF LONGITUDINAL BUFFER SPACE
D = SPACING BETWEEN DELINEATION DEVICES

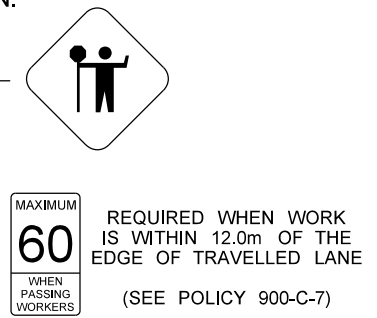
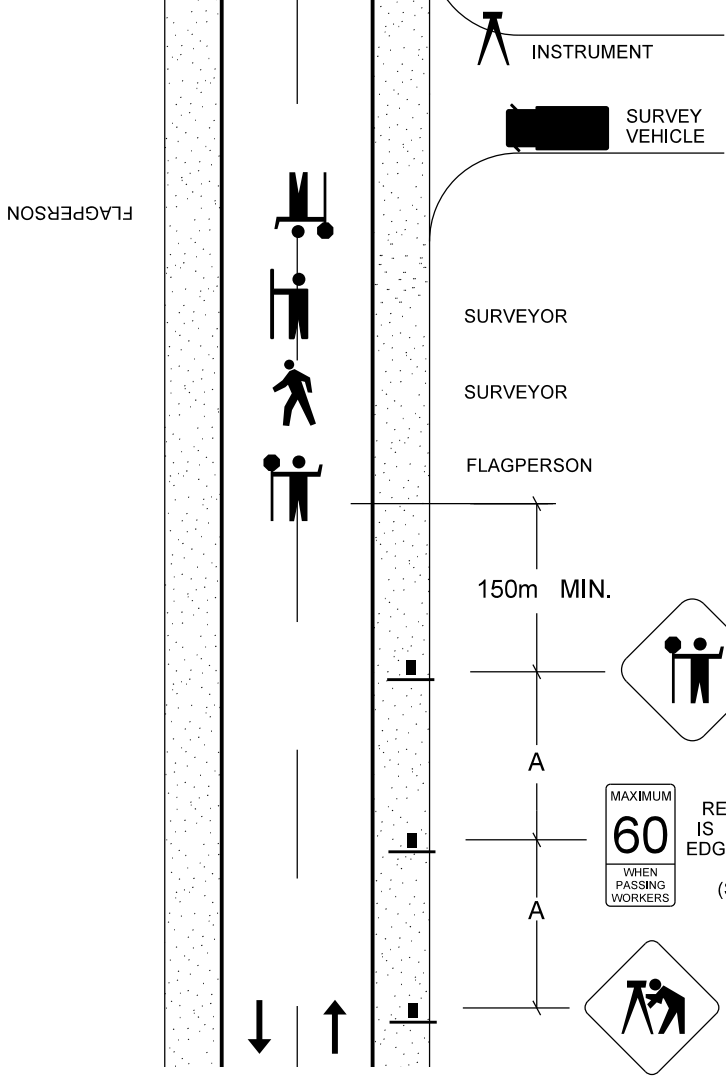

DRAFT

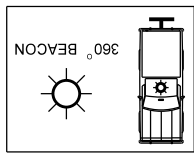

(SEE POLICY 900-C-7)
REQUIRED WHEN WORK
IS WITHIN 12.0m OF THE EDGE
OF TRAVELLED LANE

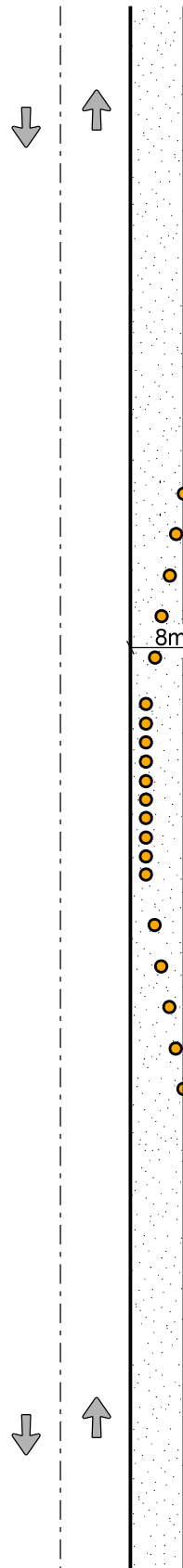
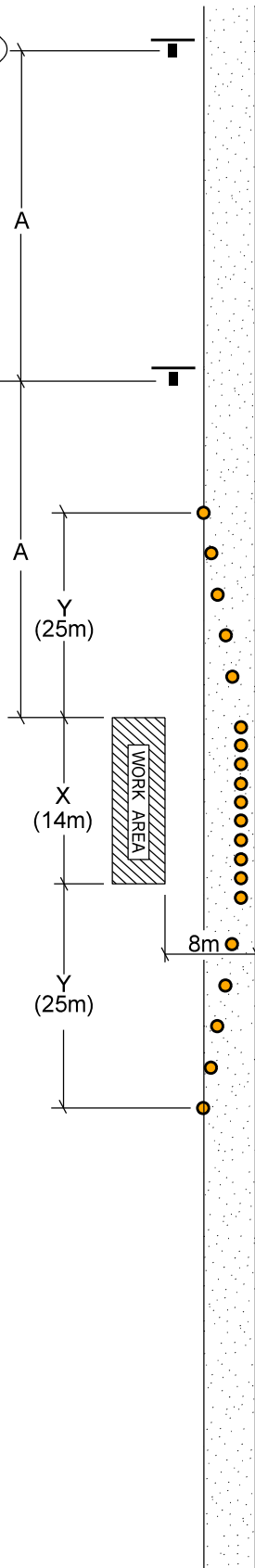
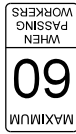

S(km/h)	A(m)	L(m)	B(m)	D(m)
50	50	60	35	15
60	50	90	45	15
70	75	120	50	15
80	100	175	55	15
90	100	200	65	20
100	150	250	70	20

WHERE:

S = SPEED LIMIT

A = SPACING BETWEEN SIGNS

L = LENGTH OF TAPER (SEE POLICY 900-B-12 FOR CHANNELIZATION DEVICE)

B = LENGTH OF LONGITUDINAL BUFFER SPACE

D = SPACING BETWEEN DELINEATION DEVICES

X = DELINEATION DEVICES (REFLECTORIZED PLASTIC DRUMS) @ 2m SPACINGS & 1m OFFSET FROM EDGE OF ROADWAY

Y = DELINEATION DEVICES (REFLECTORIZED PLASTIC DRUMS) @ 5m SPACINGS TAPERED OVER WIDTH OF SHOULDER



REQUIRED WHEN WORK
IS WITHIN 12.0m OF THE EDGE
OF TRAVELLED LANE

(SEE POLICY 900-C-7)

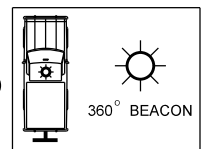

- NO SIGNS REQUIRED -

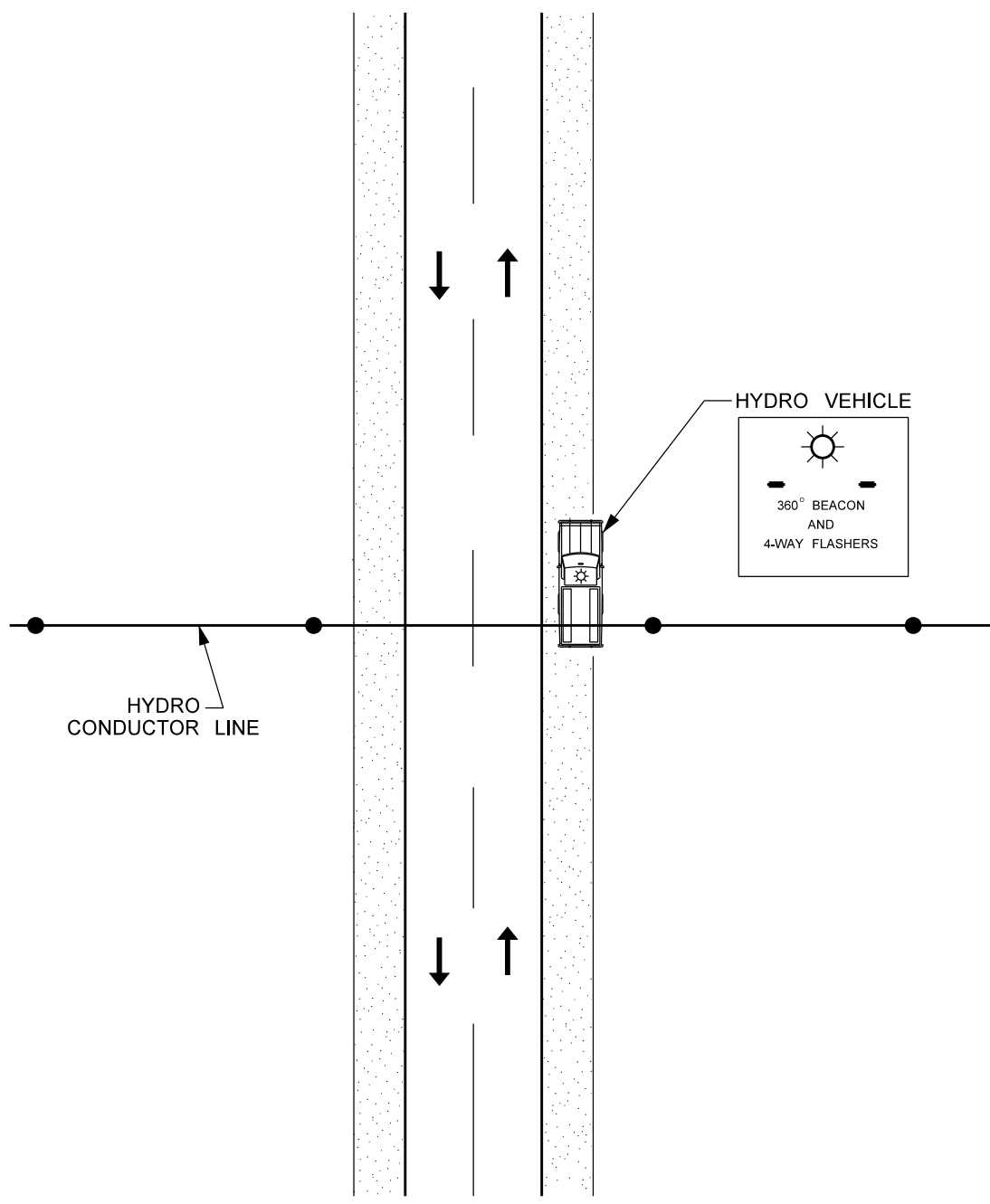

DRAFT

BUILDING MOVES (INCLUDING GRAIN BINS)

- NO SIGNS REQUIRED -

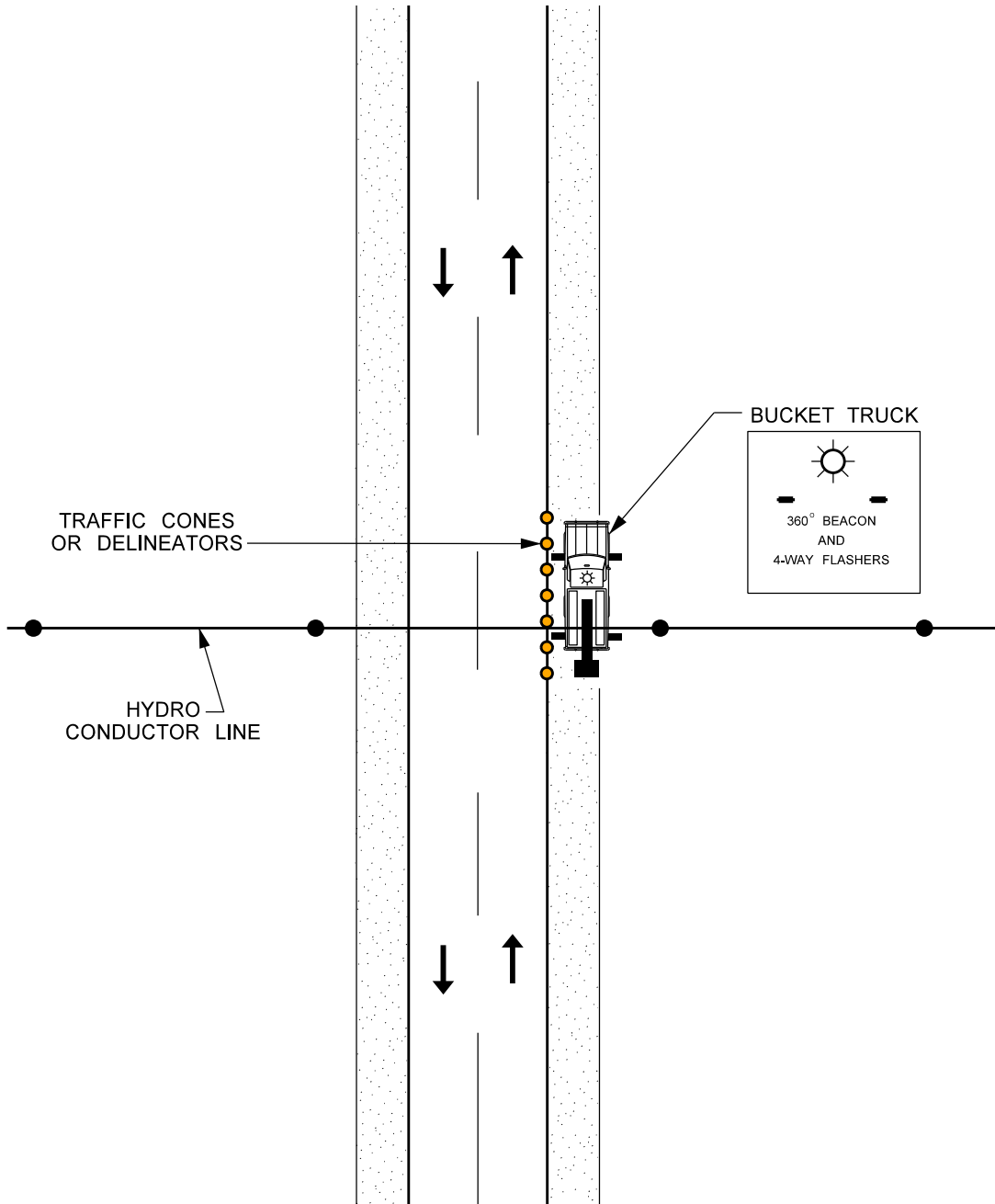

DRAFT

BUILDING MOVES (INCLUDING GRAIN BINS)

S(km/h)	A(m)
50	50
60	50
70	75
80	100
90	100
100	150

WHERE:
S = SPEED LIMIT
A = SPACING BETWEEN SIGNS

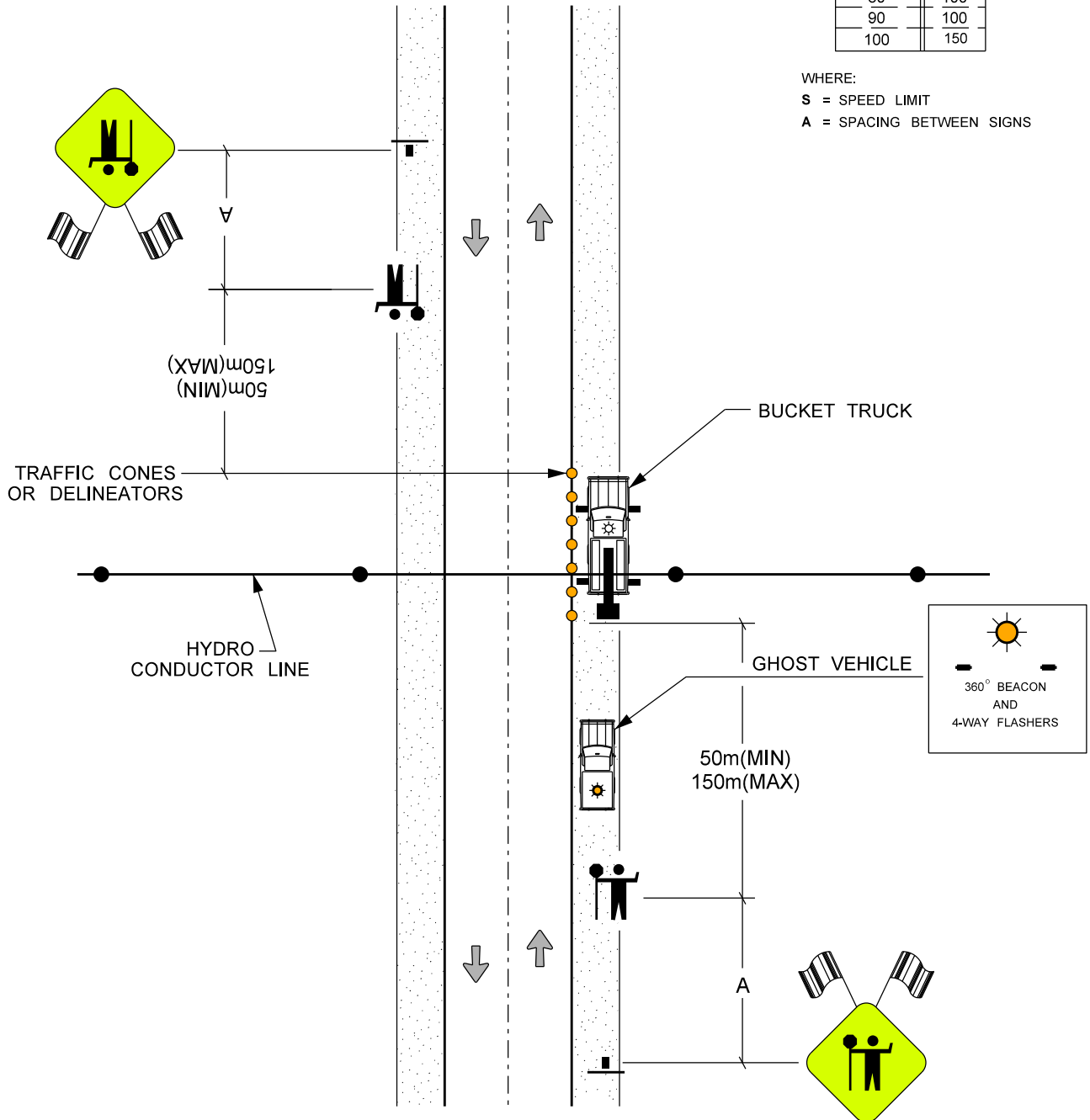

NOTE:

ADDITIONAL FLAG PERSON
REQUIRED WHEN QUEUE
REACHES FLAGPERSON SIGN.

ADVANCE WARNING WITH
ADDITIONAL FLAG PERSON SIGN.

DRAFT

**WORK ZONE
TRAFFIC SIGN SCHEDULE**



**Provincial Roads
and
Provincial Trunk Highways**

2010

GROUP 1



180 mm text

MC-1

1200 x 1200



TC-2

900 x 900



125 mm text

WA-28S

900 x 450



TC-10

900 x 900

GROUP 2



125 mm text

MC-4



175 mm text

MC-37



WA-22



125 mm text

MC-55



125 mm text

MC-6



125 mm text

MW-87



WA-23



TC-47



125 mm text

MW-90

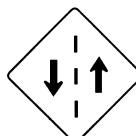

WB-3



175 mm text

MC-32



125 mm text

MC-33



TC-49

NOTES:

- Sign and text sizes are shown in millimetres.
- The minimum size of the signs shall be 900 x 900 unless otherwise shown.
- Specifications for sign reflectivity can be found in Section 3.5 at this Internet Site:

<http://www.gov.mb.ca/mit/contracts/pdf/manual/200.pdf>

GROUP 3



TC-5 R



WC-5

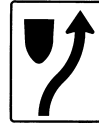

RB-25

600 X 750



RB-31

900 X 900



TC-21



WA-7 S

600 X 600

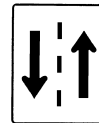

RB-24

600 X 750



MR-96

750 X 1200

GROUP 4



RB-32

900 X 900



TC-4

900 X 900

SPECIAL

PILOT VEHICLE

FRONT: 200 mm text

PILOT VEHICLE
PLEASE FOLLOW

BACK: 150 mm text

MC-42

1200 X 600



MC-44 (450 x 450)

FLAG-PERSON PADDLE

NOTES:

- Sign and text sizes are shown in millimetres.
- The minimum size of the signs shall be 900 x 900 unless otherwise shown.
- Specifications for sign reflectivity can be found in Section 3.5 at this Internet Site:
<http://www.gov.mb.ca/mit/contracts/pdf/manual/200.pdf>



**WORK ZONE
TRAFFIC SIGN SCHEDULE :**

BILINGUAL SIGNAGE

**Provincial Roads
and
Provincial Trunk Highways**

2010



MR-96



MR-96 F



MR-136



MR-136 F



TC-17



TC-17 F



MC-41



MC-41 F



MC-41 B



MC-9



MC-9 F



MC-9 B



MC-1
1200 X 1200



MC-1 F
1200 X 1200



MC-1 B
1200 X 1200



MC-4



MC-4 F



MC-4 B



MC-32



MC-32 F



MC-6



MC-6 F



MC-44 B (450 x 450)
FLAG-PERSON PADDLE



MW-82



MW-82 F



MW-90



MW-90 F



MW-87



MW-87 F



MC-33 (bilingual)



TC-10



MW-86



MW-86 F



MC-51



MC-51 F



MC-37



MC-37 F



MC-51



MC-51 F



MC-36



MC-36 F



MC-36 B



MC-55



MC-55 F



WA-28S



WA-28S F



TC-4



TC-4 F



TC-4 B

CLEARVIEW-2-B

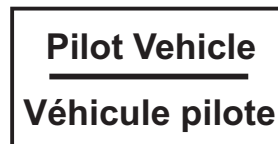

MC-42 B (FRONT)



MC-42 B (BACK)

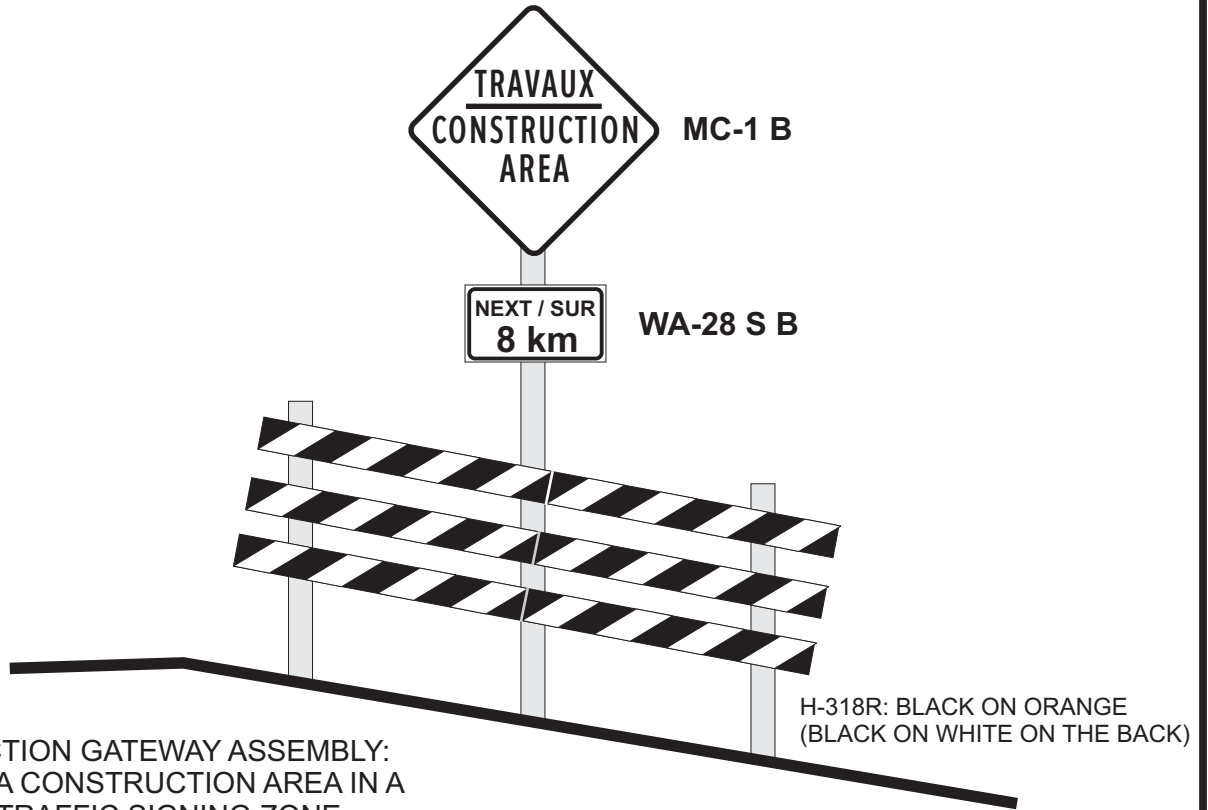

CONSTRUCTION GATEWAY ASSEMBLY:
ENTERING A CONSTRUCTION AREA IN A
BILINGUAL TRAFFIC SIGNING ZONE

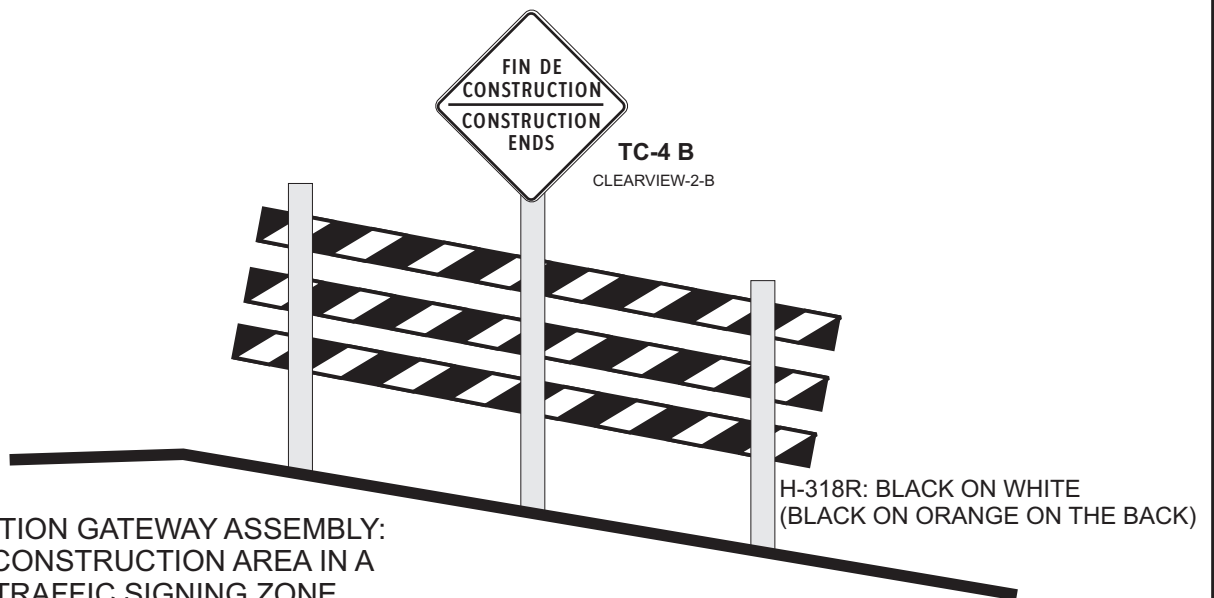

CONSTRUCTION GATEWAY ASSEMBLY:
LEAVING A CONSTRUCTION AREA IN A
BILINGUAL TRAFFIC SIGNING ZONE